

# AV-640

## 8 Band Vertical Antenna

### INSTRUCTION & ASSEMBLY MANUAL

**WARNING:**

You can be killed if the antenna, feedline, or the equipment used to install the antenna accidentally contacts utility lines. Never install an antenna near utility lines.

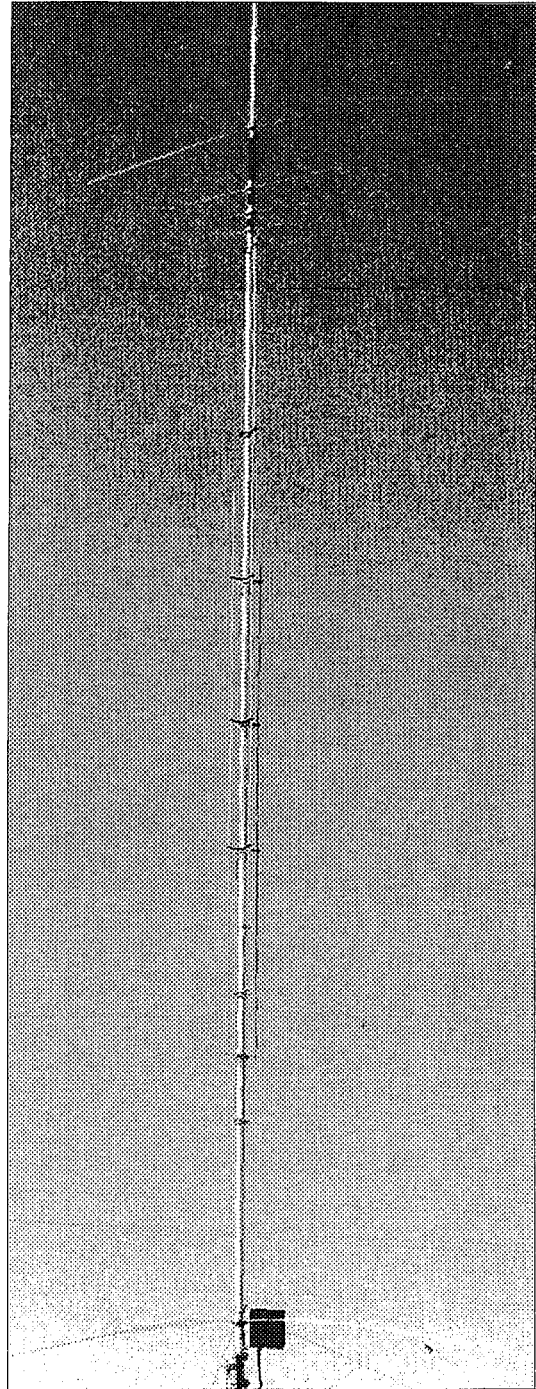

**hy-gain**

308 Industrial Park Road, Starkville, MS 39759

**AV - 640**  
**Vertical Antenna**  
**Instruction Manual**

**Table of Contents**

<b>Topic</b>	<b>Page</b>
Introduction	3
Theory of Operation	3
AV-640 Specifications	4
Antenna Location	5
Antenna Mast	6
Antenna Grounding	6
Antenna Guying	6
Customer Supplied Components	6
Tools Required for Assembly	7
Safety Precautions	7
Verification of AV-640 Parts	8
Assembly Procedure	11
Installation Procedure	16
Tuning Procedure	17
Maintenance	18
Technical Assistance	18
Warranty	30

**Table of Illustrations**

<b>Illustration</b>	<b>Page</b>
Chart A	19
Chart B	19
Figure A	20
Figure B	21
Figure C	22
Figure D	23
Figure E	24
Figure F	25
Figure G	26
Figure H	27
Figure I	28
Figure J	29

**WARNING: Improper installation and assembly can be hazardous!**  
**Read these instructions thoroughly before attempting to install or operate this product. High power transmitting devices produce voltages that can cause severe burns or other injuries.**

## **Introduction**

Hy-Gain is proud to deliver the AV-640 Eight Band Vertical. Drawing on our many years of Amateur Radio HF and VHF antenna design experience, we have produced a well-engineered antenna capable of maximum efficiency, unmatched performance, and superior construction.

Computer optimization of the AV-640 design yields the most efficient 3/8 wavelength electrical design with maximum gain and low angle of radiation for long distance communication. No traps are used to achieve eight band performance. The AV-640 is resonant on 6, 10, 12, 15 and 17 meters with individual 3/8 wavelength radiators. The center radiator resonates on 20, 30 and 40 meters using parallel end loaded Teflon wire coils. Capacity hats on these bands give wide 2:1 VSWR bandwidth and the antenna is kept to a height of 26 feet by the low inductance coils. There are no "tricks" or "mystery resonances" used for impedance matching on any band.

No long-wire radials or counterpoise kits are necessary for operation of the AV-640. The AV-640 is self contained for simple, convenient portable or fixed operation.

Mechanical construction of the AV-640 is designed for extreme light weight and high wind survival. Aircraft grade 6063-T832 aluminum and high strength fiberglass are used for the entire radiator. The trap-free design presents a very low wind surface area. Bulky tubing is not required to support unwieldy traps. The broad 2:1 VSWR bandwidth on all bands lessens large frequency shifts seen in other antennas when the antenna is wet or iced.

The AV-640 is covered by our Hy-Gain Warranty and supported by our customer service team. We would like to thank you for purchasing this product from us and ask that you let us know of any suggestion you may have. With proper assembly, installation, and maintenance, your AV-640 will provide years of faithful service.

## **Theory of Operation**

The AV-640 HF Multiband Vertical antenna consists of an end fed radiator that is resonant in the 6, 10, 12, 15, 17, 20, 30 and 40 meter amateur frequency bands. Resonances on each band are the result of impedance matching a 3/8 wavelength element with a broadband RF transformer. The characteristic impedance at the base of the 3/8 wavelength radiator is in the order of a few hundred ohms.

To match this impedance two tools are employed. First a counterpoise of 72" spokes is mounted at the AV-640 base. The capacitance from this ground plane

helps lower the base impedance. Second, a 4:1 toroidal transformer (voltage balun) steps the base impedance down to 50 ohms. This transformer uses (2) ferrite cores for high power capability. Also, the windings are made of twisted pair wire to improve coupling and reduce loss. A second high power transformer is configured as a 1:1 current balun to help stop RF from traveling back on the feedline shield. The radiator of the AV-640 is at DC ground potential for static drain. This is accomplished by a radio frequency choke in

The center radiator of the AV-640 supports 1/4 wavelength stubs for 6 , 10, 12 and 17 meters. The stubs are placed approximately one tenth of a wavelength (electrically 1/8 wavelength) above the AV-640 base. At the top of each stub the impedance is very high at the frequency the stub is tuned. This high impedance stops, (chokes) RF at this point creating a resonant 3/8 wavelength radiator. There is minimal loss using this method as compared to standard trap circuits. Also, VSWR bandwidth is not restricted by the "Q" of trap components. On 15 meters, the center radiator is terminated with a capacity hat to form a 3/8 wavelength radiator. No stub or coil is used on 15 meters. For 20, 30 and 40 meters, a coil and capacity hat are used on each band to create a 3/8 wavelength radiator. The coils are mounted at the top of the center radiator. These three coils are connected in parallel. Parallel connection separates each band to allow individual band tuning and has less loss than does series connection. Also, the AV-640 coils have significantly less loss than a standard trap because the AV-640 capacity hats exhibit greater capacitance than a typical trap, therefore, less inductance is required.

## **AV-640 Specifications**

<b>VSWR at Resonance:</b>	Less than 1.5:1 at antenna typical
<b>Gain:</b>	3 dBi nominal
<b>Height:</b>	25 ft 10 in
<b>Weight:</b>	22 lbs
<b>Horizontal Radiation Angle:</b>	360 degrees
<b>Vertical Radiation Angle:</b>	16 degrees at 1/4 wavelength high
<b>Wind Surface Area:</b>	2.5 sq ft
<b>Wind Survival:</b>	80 mph

Band (m)	2:1 VSWR (KHz)	POWER		
		CW (Watts Out)	SSB (PEP Watts)	RTTY (Watts Out)
40	150	1500	1500	500
30	175	1500	1500	500
20	500	1500	1500	500
17	500	1500	1500	500
15	500	1500	1500	500
12	500	1500	1500	500
10	1500	1500	1500	500
6	1500	300	300	100

***WARNING: Improper installation and assembly can be hazardous! Read these instructions thoroughly before attempting to install or operate this product. High power transmitting devices produce voltages that can cause severe burns or other injuries.***

## Antenna Location

The best performance for receiving and transmitting will be obtained by mounting the antenna in a clear location above or away from buildings, towers, feedlines, utility wires, and other antennas. While your own ingenuity and particular circumstances will determine the final mounting method, remember, any object within 75 feet from the base of the antenna can influence the performance of the AV-640.

***WARNING: Always mount this antenna so that it is out of the reach of adults as well as children and pets. The counterpoise rods can cause injury and or severe RF burns.***

- *Never* mount this antenna in a location that will permit unsuspecting people to come in contact with any part of the antenna
- *Never* mount this antenna where a mechanical failure might allow the antenna, antenna support or feedline to contact power lines or other utility wires.
- *Always* ground the feedline at the point where it enters a building to a good earth ground for lightning protection.
- *Always* follow the guidelines for antenna installations as recommended by the US Consumer Product Safety Commission.

## **Antenna Mast**

The recommended support mast for the AV-640 is steel water pipe between the sizes of 1-1/4" OD to 2 1/2" OD and with a length that will place the antenna base at a safe height. Do not use thin walled conduit, aluminum tubing, or "TV" mast. The AV-640 is designed to operate at a height of 8 or more feet for proper performance. Placement on the side of a house or garage at eaves level is acceptable as long as the counterpoise whips will not be in contact any snow on the roof Placement above metal roofs is acceptable if the antenna base is at least 5 feet or more above the metal surface.

## **Antenna Grounding**

Although the AV-640 is designed to operate efficiently without the requirement of an earth ground, SAFETY GROUNDING must still be provided to protect equipment, property and persons from the hazards of lightning strikes and other weather related electrical discharges. In addition the coaxial cable feeding the antenna should have the shield grounded to eliminate the risk of any indoor equipment failure from allowing hazardous voltages from appearing indoors and creating a shock hazard. The support mast should be grounded with a large diameter ground wire.

The AV-640 is DC grounded for static discharge. This is accomplished with a choke coil in the Matching Unit. This coil could fail under high voltage spikes from a near or direct lightning strike.

Additional protection can be accomplished by grounding the shield of the coax where it enters the building to a good earth ground or directly burying the cable in the earth for several feet before it enters the building. The coaxial cable should be totally disconnected from the station during threatening weather conditions for maximum lightning protection.

## **Antenna Guying**

For normal operation up to 80 mph winds, the AV-640 will not require guying. For extreme locations such as tall building rooftops, a safety guy is recommended. Use Dacron® rope to guy the center radiator. Attach ropes 14 feet above the antenna base. Use care not to disturb the radiator stubs.

## **Customer Supplied Components**

- Quality low-loss 50 ohm coax cable with PL-259 connectors
- VSWR Analyzer (MFJ-259B or equiv.) or HF transceiver with VSWR meter
- Mounting mast with required hardware to provide sturdy support

### Tools Required For Assembly

- 1/4" Standard Blade Screwdriver
- #1 Phillips Screwdriver
  - #2 Phillips Screwdriver
  - 3/8" Open End Wrench
  - 3/8" Nut Driver
  - 5/16" Nut Driver
  - 5/16" Open End Wrench
- 7/16" Nut Driver
- 7/16" Open End Wrench
- 10 nun Open End Wrench
  - Tape Measure 20'
- Safety Glasses
- Pliers

### Safety Precautions

**WARNING: You can be killed if the antennas, feedline, or the equipment used to install the antenna accidentally contacts any utility lines. Never install an antenna near power lines!**

- **Be careful while climbing and carrying the antenna. It is heavy enough to cause you to lose your balance if it is handled too casually or if any part of the antenna snags on a gutter, ladder, tree, or other item.**
- **Mount the antenna high enough and in the clear so that it is out of reach by any person or pet. Do not allow trees or other structures near the radiator portion of the antenna. The counterpoise whips can cause serious eye injury.**
- **Ensure that the mast is sturdy enough to support the weight of this antenna including the windload of the antenna.**

## Verification of Parts

Refer to the Box Contents and Parts Bags listings below to identify all parts. Also, refer to Page 10 for drawings for the various brackets used in the AV-640. If any part is missing or damaged, turn to the Technical Assistance portion of this manual. There is extra hardware supplied with the antenna. All hardware is Stainless Steel.

### Box Contents

Part Number	Part Description	ID Number	Quantity	Received
17-AV620-4	Instruction Manual Bag	IM	1	
17-AV620-1	Parts Bag #1	PB1	1	
17-AV620-2	Parts Bag #2	PB2	1	
17-AV620-3	Parts Bag #3	PB3	1	
80-AV620-1	AV-640 Matching Unit	MU	1	
810-0620-1	Base Insulator 1 1/4" x 12"	IN	1	
11-AV640-1	AV-640 Coil Assembly	L1	1	
810-0640-5	Base Tube 1 1/2" x 12"	BA	1	
17-AV640-9	Small Tube Bundle	ST	1	
810-0640-2	Radiator Section 1 1/2" x 72"	BB	1	
810-0640-3	Radiator Section 1 3/8" x 75"	BC	1	
810-0640-4	Radiator Section 1 1/4" x 75"	BD	1	
810-0640-9	Radiator Section 5/8" x 36"	BE	1	
17-AV640-10	Spoke Bundle	BS	1	
738-0620	Antenna Mounting Plate	AM	1	

### Small Tube Bundle

Part Number	Part Description	ID Number	Quantity	Received
810-0620-21	Stub Section 1/4" x 36"	CG	1	
810-0620-14	Stub Section 1/4" x 48"	CF	1	
810-0620-15	Stub Section 1/4" x 72"	CE	3	
810-0640-16	Stub Section 3/16" x 19"	CA	1	
810-0640-17	Stub Section 3/16" x 32"	CD	1	
810-0640-18	Stub Section 3/16" x 34"	CC	1	
810-0640-19	Stub Section 3/16" x 57"	CH	1	
738-2764	72" Stainless Steel Whip	CW	7	

### Spoke Bundle

810-0640-24	1/8" x 6" Aluminum Rod	SP1	2	
810-0640-25	1/8" x 12" Aluminum Rod	SP2	4	
810-0640-26	1/8" x 24" Aluminum Rod	SP3	4	
810-0640-27	1/8" x 36" Aluminum Rod	SP4	4	
810-0640-28	1/8" x 40" Aluminum Rod	Spares	2	



## Parts Bag Contents

### Instruction Manual Bag

Part Number	Part Description	ID Number	Quantity	Received
925-AV620	AV-620 Instruction Manual	MN	1	
925-1007	Hy-Gain Warranty Card	WC	1	
924-1780	Warning Label	WL	2	

### Parts Bag #1

Part Number	Part Description	ID Number	Quantity	Received
656-0375S	6-32 x 3/8" Screw SS	S1	48	
656-0500S	6-32 x 1/2" Screw SS	S2	4	
656-1250S	6-32 x 1 1/4" Screw SS	S4	10	
656-1500S	6-32 x 1 1/2" Screw SS	S3	6	
656-1750S	6-32 x 1 3/4" Screw SS	S5	2	
705-0632S-K	6-32 Nut Keps SS	N1	71	
660-0375S	10-32 x 3/8" Screw SS	S6	8	
660-1500-XB	Stub Splice 3/16 x 1 1/2"	SS	3	
711-1037S	#10 Lock Washer SS	W1	4	
705-1032S	10-32 Nut SS	N2	8	
705-1032SNL	10-32 Nut Nylon Insert SS	N3	8	
662-2000S	1/4-20 x 2" Bolt SS	S8	4	
662-2500S	1/4-20 x 2 1/2" Bolt SS	S9	4	
705-2520SNL	1/4-20 Nut Nylon Insert SS	N5	8	
745-3108S	1" Hose Clamp SS	HC2	1	
745-3116S	1 1/2" Hose Clamp SS	HC1	3	
745-3108	Counterpoise Ring SS	R1	2	
765-1009	Plastic Cap 1/4"	C1	3	
765-1000	Plastic Cap 5/8"	C2	1	

### Parts Bag #2

Part Number	Part Description	ID Number	Quantity	Received
735-1610	Radiator Clamp Bracket	RB	16	
758-9195	Mast Saddle	MS	2	
808-1786-6	Mast Plate	MP	2	

### Parts Bag #3

Part Number	Part Description	ID Number	Quantity	Received
758-9200	2 1/2" U-Bolt Assembly SS	UB	2	
735-1618	Single Stub Base Bracket	SB1	2	
735-1611	Dual Stub Base Bracket	SB2	1	
737-8100	Single Stub Insulator	P3	5	
738-2600	90 Degree Stub Insulator	P1	2	
738-2602	180 Degree Stub Spacer	P2	2	
11-AV620-1	Jumper Wire	J1	1	

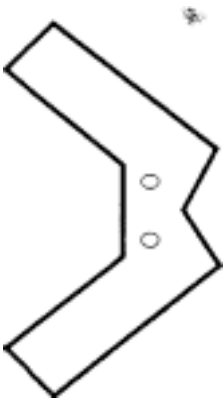

90 Degree Stub Insulator  
P/N 738-2600 Qty (2)  
Plastic  
ID# P1

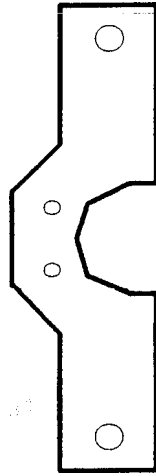

180 Degree Stub Insulator  
P/N 738-2602 Qty (2)  
Plastic  
ID# P2

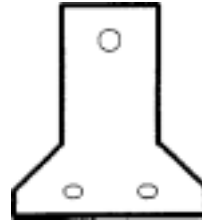

Single Stub Insulator  
P/N 737-8100 Qty (5)  
Plastic  
ID# P3

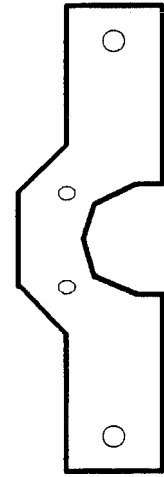

Dual Stub Base Bracket  
P/N 735-1611 Qty (1)  
Aluminum  
ID# SB2

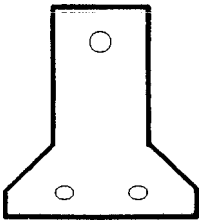

Single Stub Base Bracket  
P/N 735-1618 Qty (2)  
Aluminum  
ID# SB1

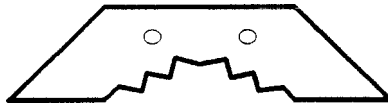

Radiator Clamp Bracket  
P/N 735-1610 Qty (16)  
Aluminum  
ID# RB

## TASK I

### Center Radiator Assembly

( ) Refer to Figure A to assemble the Center Radiator. Attach BA tubing section to either end of the Base Insulator (IN) with (2) 1/4-20 x 2" bolts (S8) and (2) 1/4-20 nylock nuts (N5). Do not tighten the nuts at this time.

( ) Find the (2) counterpoise rings (RI). Press the flat sides of the rings together and slide them onto the Base Insulator (IN). Leave rings loose at this time.

( ) Attach the drilled end of tubing section BB to the Base Insulator (IN) with (2) 1/4-20 x 2" bolts (S8) and (2) 1/4-20 nylock nuts (NS). Do not tighten the nuts at this time.

( ) Place (1) hose clamp (HC 1) over the slotted end of tubing section BB. Slide unslotted end of BC tubing section 6 inches (15 cm) into BB. Tighten hose clamp. NOTE: For protection against oxidation, a conductive paste such as NoAlox® may be used between *telescoping pieces of aluminum tubing only*. Do not apply the paste to insulators or coax connections.

( ) Place (1) hose clamp (HC 1) over the slotted end of tubing section BC. Slide unslotted end of BD tubing section 6 inches (15 cm) into BC. Tighten hose clamp.

( ) Place (1) hose clamp (HC 1) over the slotted end of tubing section BD. Insert AV-640 Coil Assembly (LI) 4 inches (10 cm) into tubing section BD. Tighten hose clamp.

( ) Place (1) hose clamp (HC2) over the slotted end of coil assembly AV-640L1. Slide an end of tubing section BE into top of L1 coil assembly. Set length to desired L40 value from Chart A (p 19).

( ) Place 5/8" plastic cap (C2) on end of tubing section BE

## TASK II

### Stub Base Bracket Assembly

( ) Refer to Figure B for Stub Base Bracket Assembly. Study Figures B and C to learn how the stub base brackets are attached for each band. Note how the brackets are offset 90 degrees from each other for proper antenna assembly.

( ) Find the aluminum Stub Brackets (SB 1 & SB2). Attach a Radiator Bracket (RB) to each Stub Bracket with (2) 6-32 x 3/8" screws (S I) and (2) 6-32 Keps nuts (N1) as shown in Figure B.

( ) Find a Single Stub insulator (P3). Attach it to a Radiator Bracket (RB) with (2) 6-32 x 3/8" screws (S I) and (2) 6-32 Keps nuts (NI).

( ) Mount each Stub Base Bracket to the AV-640 Radiator using a Radiator Bracket (RB), (2) 6-32 x 1 1/2" screws (S3), and (2) 6-32 Keps nuts (N1). Place the Single Stub insulator opposite the Single Stub Base Bracket shown in Figure C.

( ) NOTE the degrees offset for each bracket and the distance from the base insulator (IN) in Figure C. Position the Stub Brackets ABOVE the Radiator Brackets.

### TASK III

#### Stub Insulator Assembly

( ) Place the AV-640 Radiator on a flat surface such as a driveway or garage floor. This will aid in mounting the Stub Insulators by keeping them aligned with each other.

( ) Refer to Figure D for Stub Insulator Assembly. There are three types of stub insulators: Single, 90 Degree and 180 Degree. The 180 Degree insulators are used with a Single Stub insulator to make a Three Stub insulator. The locations of the Single insulators are labeled «A", 90 Degree insulators are labeled "B" and the Three Stub insulators are labeled "C".

( ) Attach 90 Degree Stub Insulators (P1) to a Radiator Bracket (RB) using (2) 6-32 x 3/8" screws (S1) and (2) 6-32 Keps nuts (N1) as shown in Figure D.

( ) Attach Single Stub Insulators (P3) to a Radiator Bracket (RB) using (2) 6-32 x 3/8" screws (S 1) and (2) 6-32 Keps nuts (N1).

( ) For Three Stub Insulators, attach a Single Stub and a 180 Degree Stub Insulator (P3 & P2) to a Radiator Bracket (RB) using (2) 6-32 x 1/2" screws (S2) and (2) 6-32 Keps nuts (N1).

( ) Mount the Stub Insulators on the AV-640 Radiator using a Radiator Bracket (RB), (2) 6-32 x 1 1/4" (S4) screws, and (2) 6-32 Keps nuts (N1). USE the dimensions in Figure E to space and rotate the insulators into their proper locations. Position the Stub Insulators ABOVE the Radiator Brackets.

### TASK IV

#### Stub Assembly

( ) Refer to Figure F for the stub assembly procedure.

( ) TEN METER STUB: Notice on the 3/16" x 32" rod CD the ends are tapped at different lengths. Thread an end of tubing section CE onto the 1" tapped length end of rod CD. Thread it on at least 3/4" (2 cm) and carefully tighten with pliers until it is tight against rod CD. Do not compress the tubing where it is threaded onto the rod.

NOTE: A small amount of WD-40® or NoAlox® can be used on these threaded connections to ease assembly. Do not use oil. WD-40 will evaporate over time and NoAlox is a conductive paste.

NOTE: THIS CONNECTION WILL NOT LOOSEN OVER TIME AS THERE IS NO TORQUE ON THE CONNECTION WHEN THE STUB ASSEMBLY IS MOUNTED ON THE ANTENNA.

( ) TWELVE METER STUB: Notice on the 3/16" x 34" rod (CC), the ends are tapped at different lengths. Thread an end of tubing section (CF) onto the 1" tapped length end of rod (CC). Thread it on at least 3/4" (2 cm) and carefully tighten with pliers until it is tight against rod CC. Do not compress the tubing where it is threaded onto the rod.

( ) Thread a stub splice (SS) into the end of tubing section CF at least 3/4" (2 cm) until it is tight inside the tube.

( ) Thread an end of tubing section (CG) onto the stub splice (SS) until it reaches tubing section CF. Carefully tighten tubing section (CG) against CF with pliers. Do not compress the tubing where it is threaded onto the stub splice.

( ) SEVENTEEN METER STUB: Notice on the 3/16" x 19" rod (CA), the ends are tapped at different lengths. Thread an end of tubing section CE onto the 1" tapped length end of rod (CA). Thread it on at least 3/4" (2 cm) and carefully tighten with pliers until it is tight against rod CA. Do not compress the tubing where it is threaded onto the rod.

( ) Thread a stub splice (SS) into the end of tubing section CE at least 3/4" (2 cm) until it is tight inside the tube.

( ) Thread an end of another tubing section (CE) onto the stub splice (SS) until it reaches tubing section CE. Carefully tighten tubing section CE against the previous tubing section CE with pliers. Do not compress the tubing where it is threaded onto the stub

( ) SIX METER STUB: Installation of the six meter stub is optional. If six meter operation is not desired do not attach the stub to the radiator. Leaving the stub off will not effect operation of the other bands. The stub is a 3/16" x 57" rod (CH). It is a single section stub and does not require assembly.

## **TASK V**

### **Stub Mounting**

( ) Refer to Figure G to install the stub assemblies on the AV-640 Radiator. The bottom of each stub assembly can be slid into the corresponding top stub insulator and fed through consecutive insulators until it reaches the corresponding stub bracket.

## 6 Meter Stub

( ) If operation on 6 meters is desired, find the six meter stub (CH). Slide the threaded end of the stub through the top of the stub insulator as shown in Figure G. Continue through the second insulator until the stub meets the Stub Base Bracket.

( ) Mount the stub in the Stub Base Bracket hole using (2) 10-32 standard nuts (N2) and a #10 Lockwasher (W 1) as shown in Figure G.

( ) Set Length L6 according to the desired operating frequencies in Chart A (Page 19).

## 10 and 12 Meter Stubs

( ) Select the 10 meter stub assembly and slide the threaded end through top of the proper stub insulator. Continue feeding the stub through the next three insulators.

( ) Attach the stub in the 10 meter Stub Base Bracket hole using (2) 10-32 standard nuts (N2) and a #10 Lockwasher (W1) as shown in Figure G.

( ) Set 10 meter stub length L10 according to the desired operating frequency in Chart A (Page 19).

( ) Select the 12 meter stub assembly and slide the threaded end through top of the proper 90 degree stub insulator. Continue feeding the stub through the next three insulators.

( ) Attach the stub in the 12 meter Stub Base Bracket hole using (2) 10-32 standard nuts (N2) and a #10 Lockwasher (W 1) as shown in Figure G.

( ) Set 12 meter stub length L12 according to the desired operating frequency in Chart A.

## 17 Meter Stub

( ) Select the 17 meter stub assembly and slide the threaded end through top of the proper 90 degree stub insulator. Continue feeding the stub through the next five insulators.

( ) Attach the stub in the 17 meter Stub Base Bracket hole using (2) 10-32 standard nuts (N2) and a #10 Lock-washer (W 1) as shown in Figure G.

( ) Set 17 meter stub length L17 according to the desired operating frequency in Chart A.

( ) Place a 1/4" plastic cap (C1) on the open end of tubing sections for each stub assembly (Figure G).

## **TASK VI**

### **Matching Unit Mounting**

- ( ) Refer to Figure G for the mounting location of the Matching Unit (MU). Use the lower pair of bolts through the Base Insulator (IN) to mount the MU as shown in Figure G. Remove the (2) 1/4-20 nuts (N5) from the (2) 1/4-20 x 2" bolts (S8) previously installed.
  
- ( ) Place the Matching Unit on the bolts and secure in place with the (2) nuts. Be sure the coax connector end of the Matching Unit faces the base (bottom) of the antenna.
  
- ( ) Using a 6-32 Keps nut (N1), connect one end of the jumper wire (JI) to the counterpoise terminal of the Matching Unit. Do not over-tighten this nut. The other end of the jumper wire is attached later.

## **TASK VII**

### **Counterpoise Assembly**

- ( ) Refer to Figure H to assemble the counterpoise.
  
- ( ) Loosely attach the counterpoise rings (RI) to the base insulator (IN) with (2) 6-32 x 1 3/4" screws (S5) and (2) 6-32 Keps nuts (N1).
  
- ( ) Loosely attach the counterpoise rings (RI) together with (8) 10-32 x 3/8" screws (S6) and 10-32 nylock nuts (N3).
  
- ( ) Place the (7) 72 inch (183 cm) counterpoise whips (CW) into the slots provided in the sides of the rings. The slot facing the Matching Unit (MU) does not receive a whip.
  
- ( ) Tighten the 10-32 nuts (N3) around the rings to secure the whips.
  
- ( ) Place the loose end of jumper wire (JI) under the closest 6-32 screw (S5) that holds a ring to the base insulator as shown in Figure H. Tighten the (2) 6-32 nuts (N 1) that secure the rings to the base insulator.
  
- ( ) Attach a warning label to the end of each whip as shown in Figure H.

## **TASK VIII**

### **Antenna Mounting Plate Assembly**

- ( ) Refer to Figure I for assembly of the Antenna Mounting Plate (AM).
  
- ( ) Place (4) 1/4-20 x 2 1/2" bolts (S9) through the Mast Plate (MP), Mast Saddle (MS), and antenna mounting plate (AM) and secure with 1/4-20 nylock nuts (N5). Do not tighten the nuts.

( ) Place the antenna base under the Mast Saddles and align the end of the base with the edge of the mounting plate as shown in Figure I.

( ) Tighten the (4) bolts to hold the antenna base in place. Do not over-tighten the nuts.

( ) Place the (2) U-bolt assemblies (UB) into the holes in the antenna mounting plate as shown in Figure I. Leave nuts loose until installation of the antenna.

## **TASK IX**

### **Capacity Hat Assembly**

( ) Refer to Figure J for assembly of the four Capacity Hats.

( ) Rotate the AV640 Coil Assembly (LI) so the top end of the 17 meter stub is away from the AV640 Coil Strap as shown in Figure J. To rotate the coil assembly, loosen the lower coil hose clamp (HC 1). Tighten hose clamp when finished.

( ) Place (8) 6-32 x 3/8" screws (S1) and (8) 6-32 Keps nuts (Ni) in each Counterpoise Ring assembly on the AV-640 Coil Assembly (LI). Leave the nuts loose so that the spokes can be slid between the rings.

( ) There are spokes of lengths 6", 12", 24", 36" and 48". Place the spokes in the ring assemblies as shown in Figure J. The shorter spokes will be on the bottom end of the coil and the longer spokes will be on the upper end of the coil. The 40" spokes are spares. Tighten all hardware on the ring assemblies. The formed ends of the spokes can be positioned in any direction.

( ) NOTE: For tuning 15, 20 & 30 meters, the lengths of a spoke is adjusted as shown in Figure J, (1,15, L20 & L30). Since the AV640 has a broad low VSWR, it is suggested the AV640 spokes be installed at their initial lengths of 6", 12", 24" & 36". If any of the bands (15, 20 & 30 meters) are resonant too low in frequency, one of the corresponding spokes can be pruned. *Only one spoke will require pruning.* Please refer to the Tuning section on Page 17 and Figure J for more information.

## **Installation**

The AV-640 antenna should be mounted at least 8 feet above ground. The main reason for this minimum height is safety. The AV-640 will work well at a minimum height of five feet but precautions from dangerous voltages must be taken.

Always have help for the installation process. Do not attempt to install the antenna alone. Review the requirements for Antenna Location and safety precautions regarding Power Lines earlier in this manual.



The easiest method of installing the AV-640 is to first mount the Antenna Mounting Plate (AM) on the support mast. Tighten the mounting plate U-Bolts. Have the Mast Saddles and Mast Plates (MS & MP) loosely mounted on the mounting plate. Raise the antenna and slide the antenna base under the Mast Saddles (MS) until the antenna base is flush with the lower edge of the mast plate (Figure I). Tighten the antenna base in place.

The AV-640 may be roof mounted on a tripod or similar support. Keep the AV-640 base a minimum of 5 feet above the roof surface. This minimum dimension is the same for any roof material type. Attach a suitable ground wire to the support mast as mentioned in the Grounding section of this manual.

## **Tuning**

The AV-640 should be checked with an VSWR meter before permanent installation to verify proper assembly and Matching Unit performance. Place the AV-640 at least 8 feet above ground and in as clear an area as possible. Connect the coax to the antenna base and test the VSWR using either an MFJ-259B VSWR Analyzer or equivalent or a transceiver and VSWR meter.

The 2:1 VSWR Bandwidth should be referenced to determine performance. VSWR measurements made at the antenna base are the most accurate and may show a slightly narrower VSWR bandwidth than the specifications chart lists. Be sure to use very low power (less than 5 watts) when measuring VSWR at the antenna base.

The AV-640 has few variables in its design. Therefore, VSWR should be very close to specifications. Each band can be adjusted individually. Refer to Chart A (Page 19) for antenna dimensions and use Chart B (Page 19) to calculate the **amount** of adjustment needed to place the AV-640 on frequency.

To adjust the 40 meter band, refer to Figure A and vary the length of L40. To raise the resonant frequency, shorten the length of L40. Use Chart B (Page 19) to, calculate the **amount** of adjustment needed to place the AV-640 on frequency.

Individual adjustment of 15, 20 & 30 meters is accomplished by pruning one spoke in the corresponding capacity hat. Only one spoke is adjusted and it does not matter which spoke is selected. Refer to Chart B to calculate the amount of spoke to prune and Figure J for spoke location. (It is unlikely 15 meters will require adjustment). Also, it is strongly suggested the AV640 be assembled and tested with the spokes at the initial lengths of 6", 12", 24" & 36" to determine if any pruning is actually required. If the resonant frequency is too high, make a longer spoke from one of the 40" spare spokes.

Stub lengths can be adjusted for tuning the 6, 10, 12 & 17 meter bands. Chart A has the length dimensions, Chart B shows the amount of length to change, and Figure G displays the stub tuning locations.

If the VSWR is less than 1.5:1 at the frequencies you operate, do not spend extra time trying to improve the VSWR. Any improvements beyond 1.5:1 yield minimal gains in antenna performance and cause excess wear on the antenna, roof or mast. Please note the length of coax will vary the VSWR on certain bands. Lengths less than 50 feet have stronger harmonic resonances than longer lengths. If a particular band will not properly resonate, try adding 3-5 feet or more of coax. Record the resonant frequencies with and without the added coax. There will be a change in resonant frequencies on one or more bands. RF loss at HF is not a major problem with RG8X or larger coax. There will be a minimal performance difference between a 50 ft. length and a 75 ft. length of coax.

To lessen the possibility of RFI/TVI, roll up 6-8 turns of coax 8" inches diameter approximately one quarter wave (or multiple) from the base of the antenna. Use the quarter wave length of the frequency that causes the greatest amount of

## **Maintenance**

The AV-640 should be inspected mechanically at least once a year. *Normal* wear and tear varies significantly with climate.

Anti-Oxidation paste such as NoAIOX® or others can be applied to the radiator tubing sections. Use small amounts. Do not place the paste on the coax connector or inside of the Matching Unit.

Inspect the inside of the Matching Unit on a regular basis. Remove dirt, bugs, or questionable material. Look for any degradation of parts. High voltage static discharges (lightning) may cause a failure to the small coil in the Matching Unit. This coil is a protection device. Make sure it is in good shape.

Do not screw and unscrew the nylon insert nuts several times. If portable operation is desired, use stainless steel hardware without the nylon locking feature.

The AV-640 may be painted. Clean all aluminum surfaces well to improve paint adherence. Paint the antenna *after* it is assembled and tuned. **DO NOT PAINT PLASTIC PARTS.**

## **Technical Assistance**

Technical assistance is available during normal business hours on weekdays. Hy-Gain is located in the Central Time Zone. Our hours are 7:00 AM till 4:00 PM CST Monday through Friday.

Hy-Gain can be reached by telephone, FAX, email and regular mail at the following addresses:

Hy-Gain  
 308 Industrial Park Road  
 Starkville, MS 39759  
 Telephone (800) 973-6572

Telephone (662) 323-9538  
 FAX (662) 323-5803  
 email "[hy-gain@hy-gain.com](mailto:hy-gain@hy-gain.com)"  
 Web Page "<http://www.hygain.com>"

Service history has shown that most problems are operating or installation errors, rather than equipment failures. Most problems can be resolved over the telephone. Please contact our staff before shipping parts or equipment to us.

The packing material used to ship this antenna is designed to prevent shipping damage. Please reuse the original shipping carton if possible. Hy-Gain will not be responsible for shipping damage on returned items with improper packing.

<b>Band Portion</b>	<b>L40</b>	<b>L30</b>	<b>L20</b>	<b>L17</b>	<b>L15</b>	<b>L12</b>	<b>L10</b>
<b>See Figure</b>	A	J	J	G	J	G	G
<b>C W</b>	28"	23 ½"	11 ½"	161"	5 ½"	116"	102 ½"
<b>CENTER</b>	21"	23 ½"	10"	161"	5"	116"	101"
<b>S S B</b>	18"	N/A	9"	160 ¾"	4"	116"	99 ½"

<b>Band Portion</b>	<b>L6</b>
<b>See Figure</b>	G
50-52 MHz	55 ½"
52-54 MHz	54 ¼"

<b>Band</b>	<b>Length Adjustment</b>
40 Meters	17 KHz per inch
30 Meters	50 KHz per inch
20 Meters	100 KHz per inch
17 Meters	60 KHz per ½ inch
15 Meters	100 KHz per inch
12 Meters	150 KHz per ½ inch
10 Meters	100 KHz per ½ inch
6 Meters	300 KHz per ½ inch

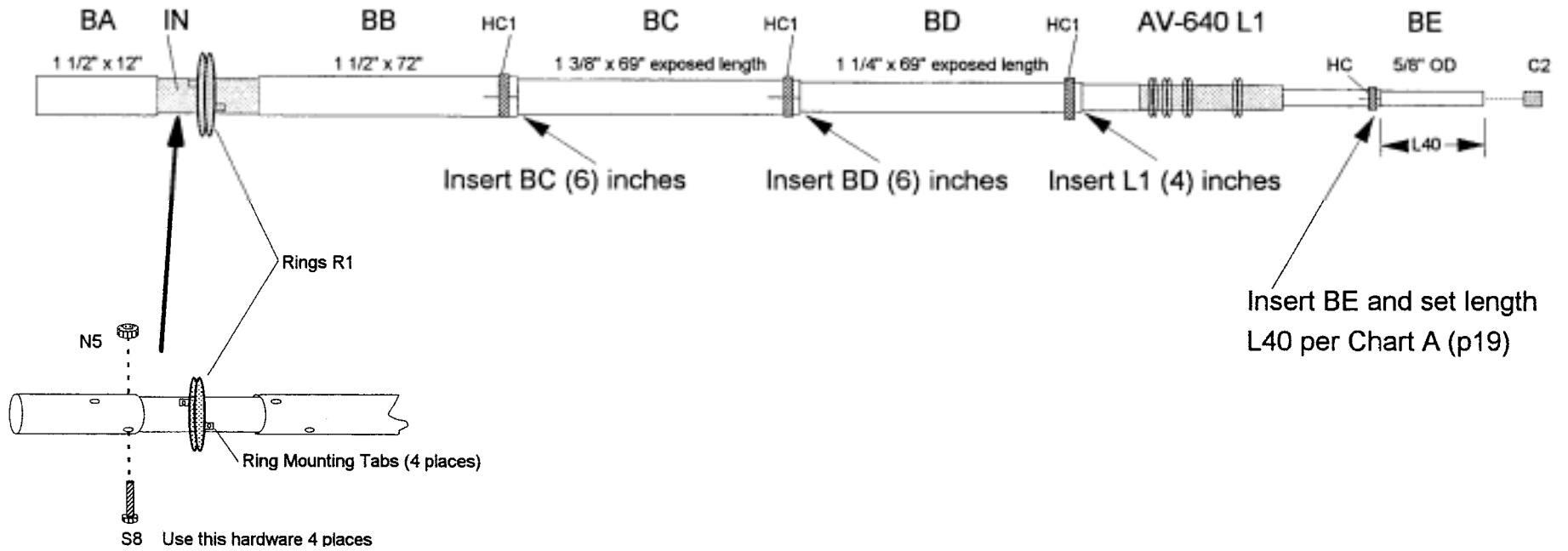
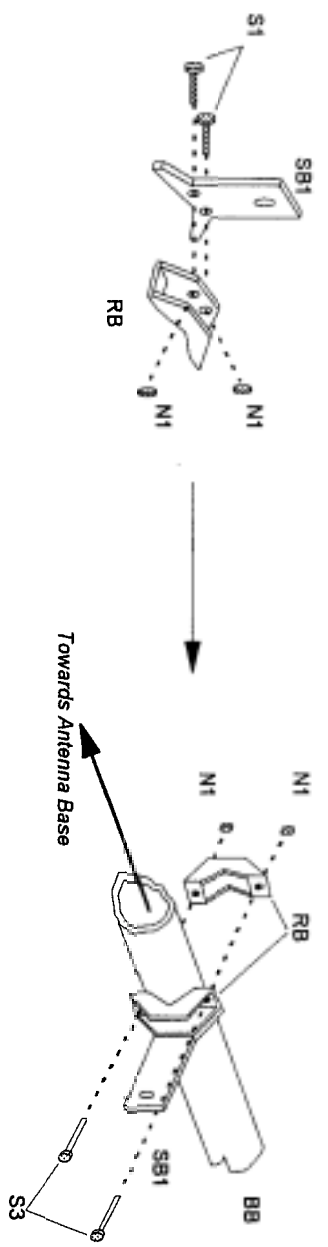
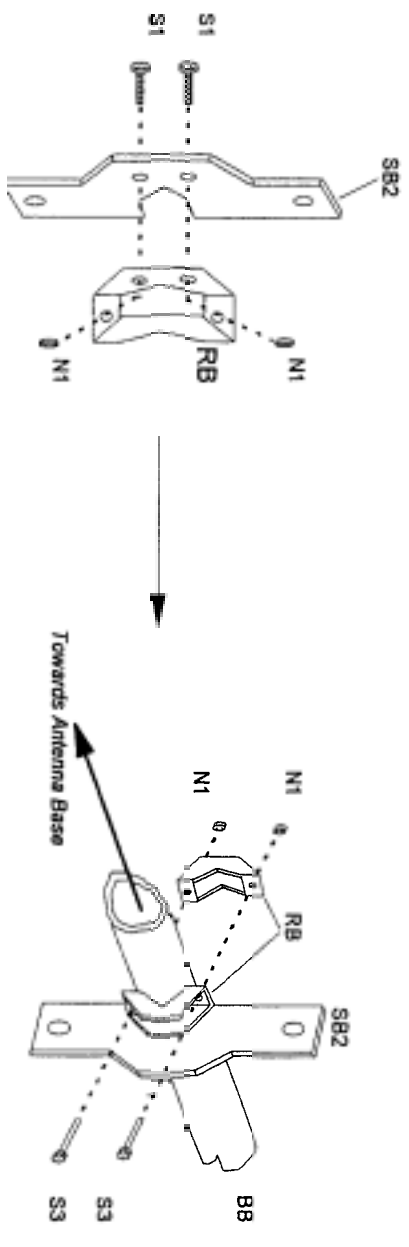

FIGURE A  
 AV-640 Center Radiator Assembly

NOTE: Mount Stub Brackets  
above Radiator Bracket Clamps



**A** 6 Meter Stub Base Bracket



**B** 10 & 12 Meter Stub Base Bracket

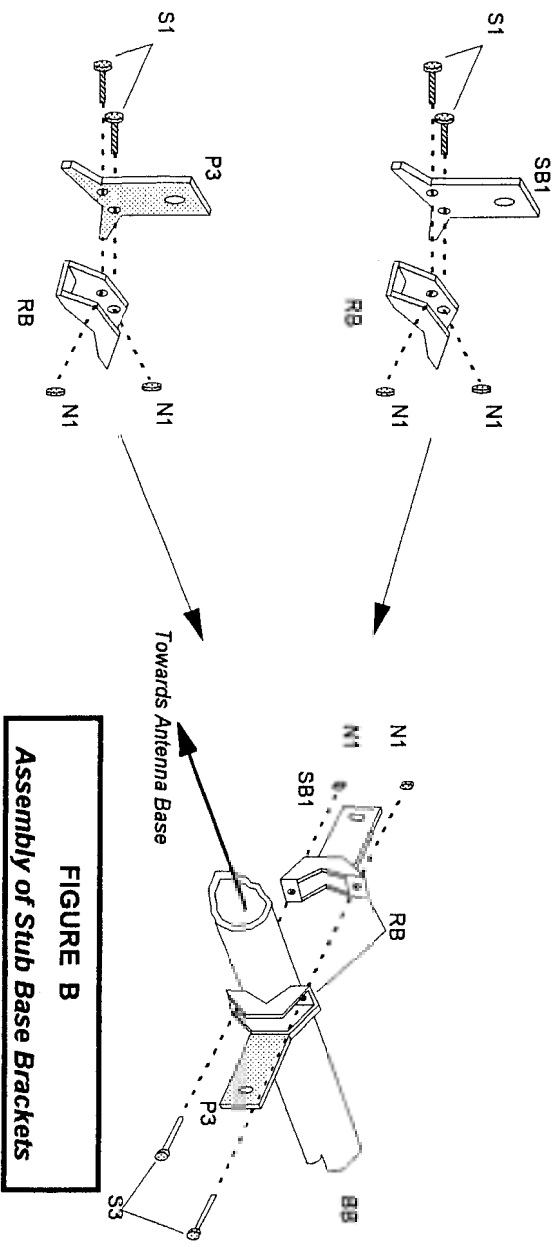

**C** 17 Meter Stub Base Bracket and  
6 Meter Stub Insulator

**FIGURE B**  
**Assembly of Stub Base Brackets**

Measurements are from the bottom of BB to the top of each Stub Bracket

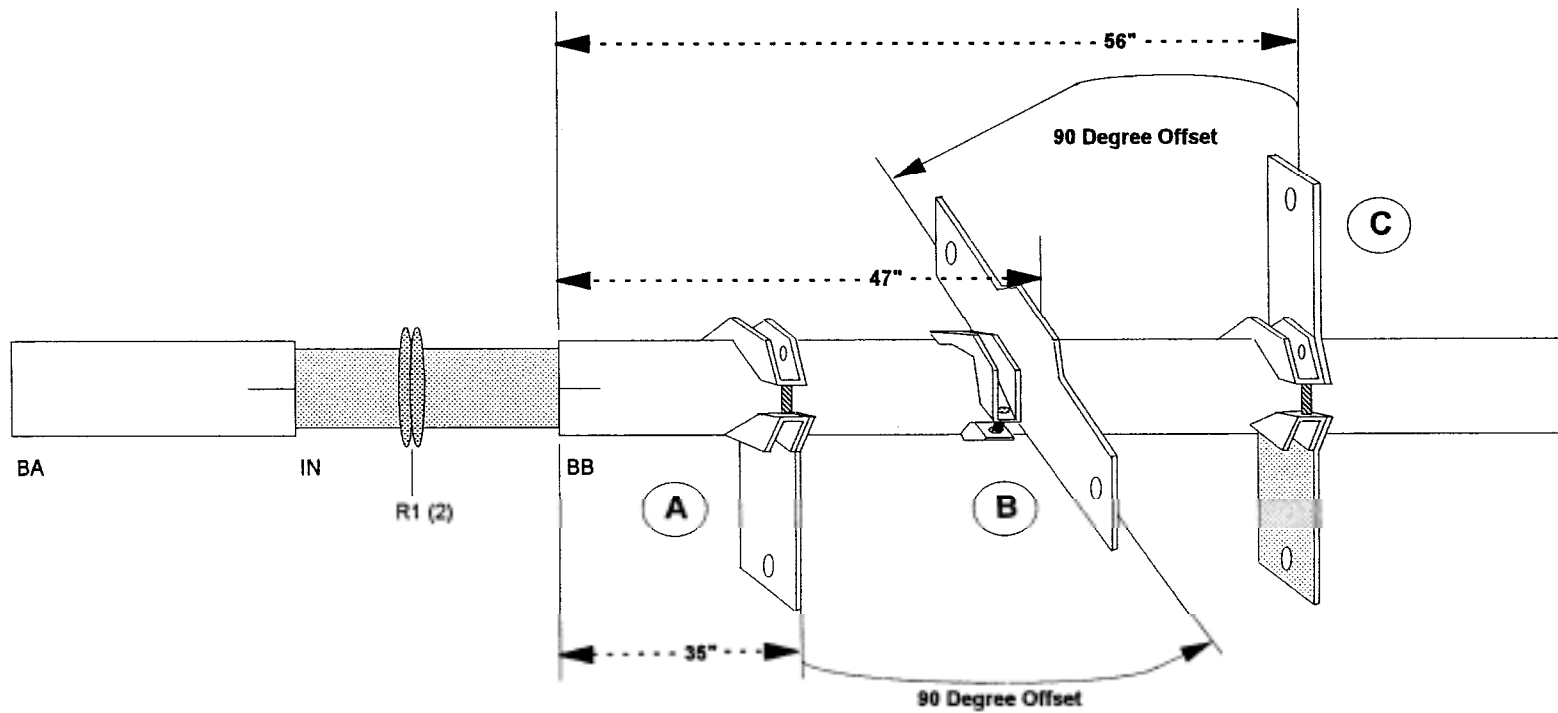

- A** 6 Meter Stub Base Bracket
- B** 10 & 12 Meter Stub Base Bracket
- C** 17 Meter Stub Base Bracket and  
6 Meter Stub Insulator

FIGURE C  
Installation of AV-640 Stub Base Brackets

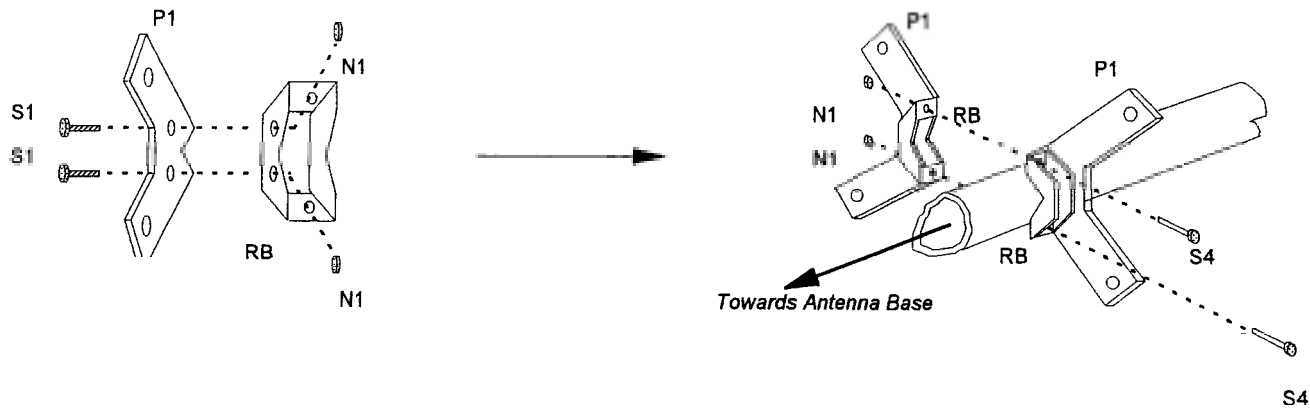

NOTE: Mount Stub Insulators  
above Radiator Bracket Clamps

**D** 90 Degree Stub Insulators

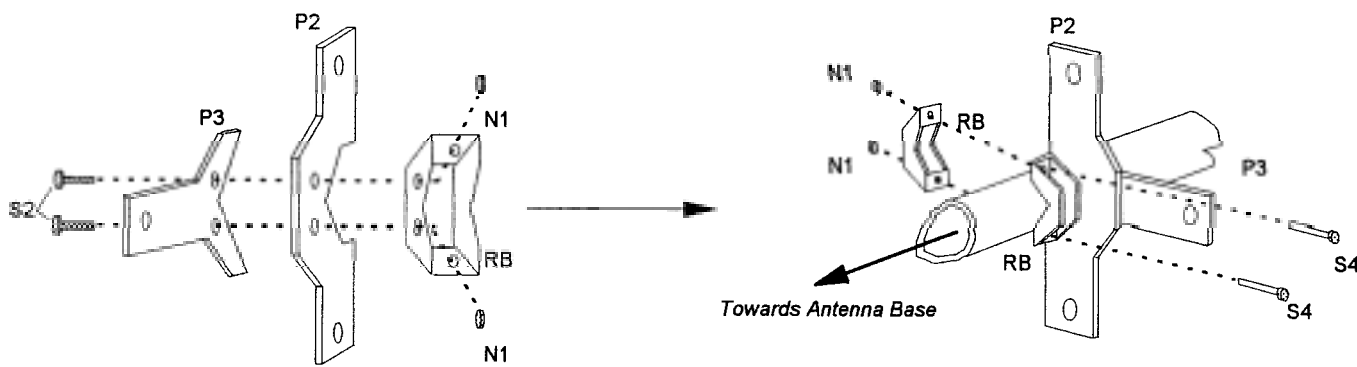

**E** Three Stub Insulator

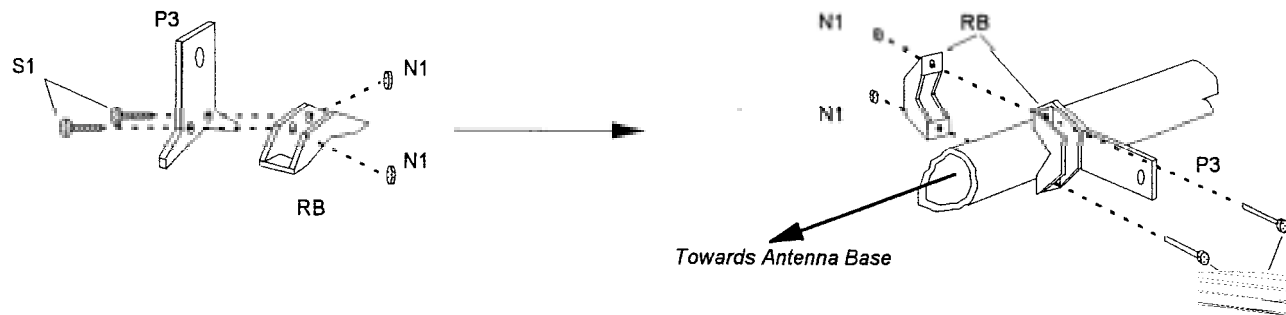

**F** Single Stub Insulator

FIGURE D  
*Installation of Stub Insulators*

NOTE: Align Spacers as shown. Keep corresponding holes in line. Assembling antenna on a flat surface will help.

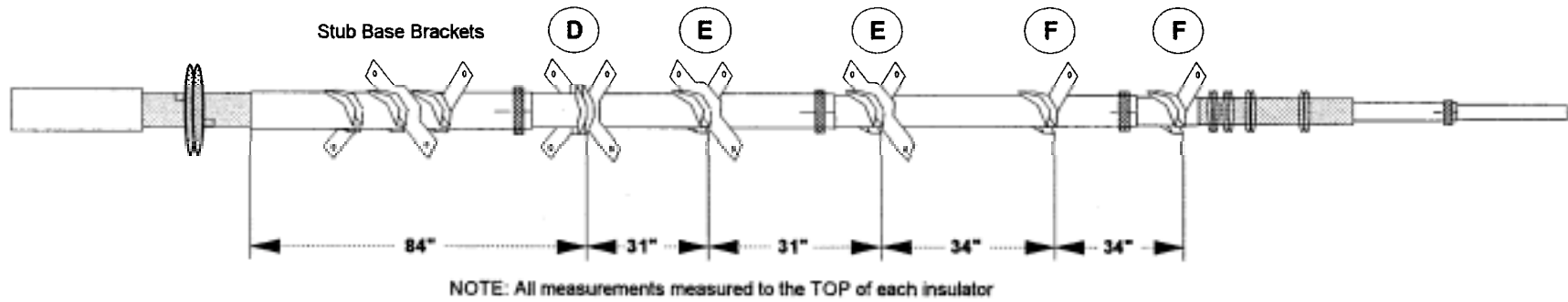

D 90 Degree Stub Insulators

E Three Stub Insulator

F Single Stub Insulator

FIGURE E  
Installation of Stub Insulators



### 10 Meter Stub Assy

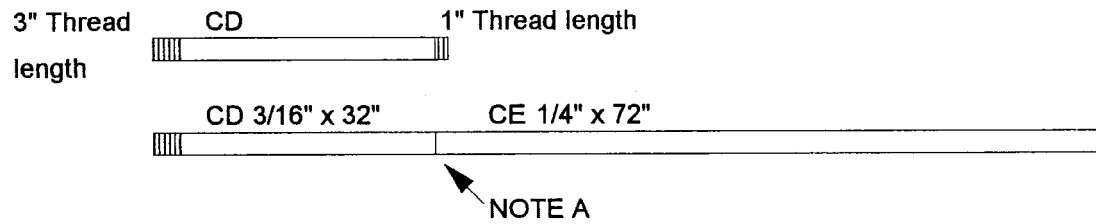

### 12 Meter Stub Assy

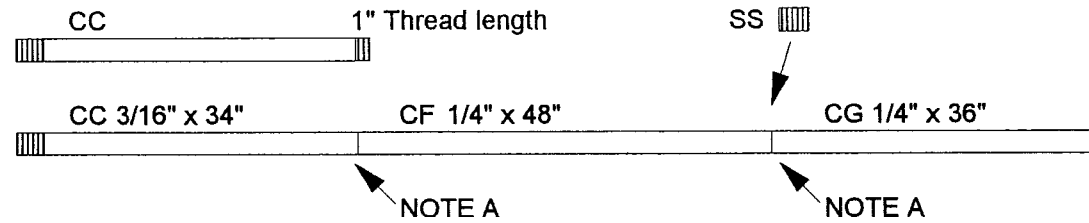

### 17 Meter Stub Assy

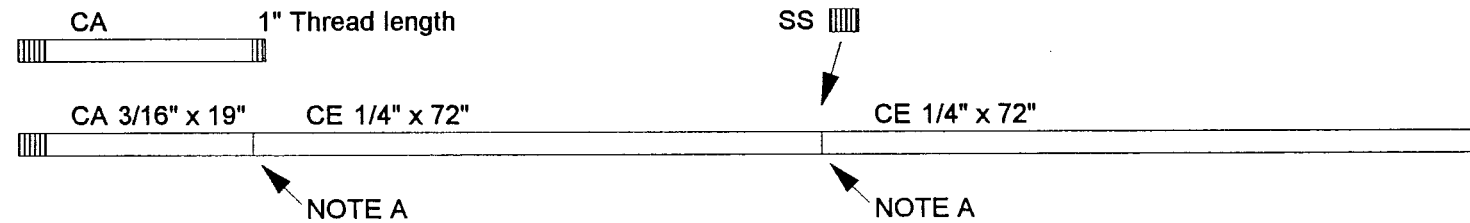

### 6 Meter Stub

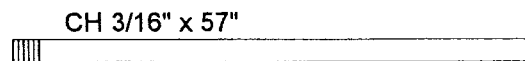

NOTE A: When tightening connections, do not compress tubing where it is threaded onto the 3/16" rods or onto a Stub Splice. Carefully grip pliers 1" (2.5 cm) away from tube end.

FIGURE F  
*Stub Assembly*

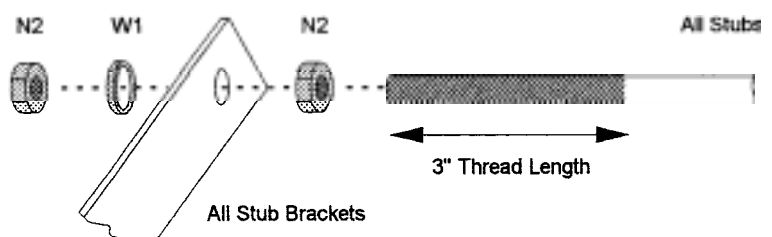
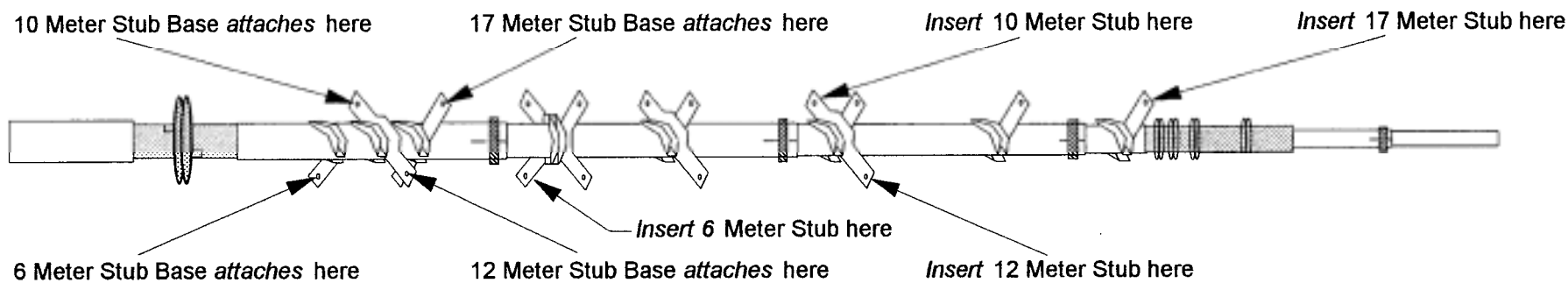

NOTE: To adjust resonant frequency of each band, adjust the length of the specific stub where it enters the Stub Bracket (shown above). Measure Stub Length from the top of the Stub Bracket to the top of the stub. All stub lengths are listed in CHART A.

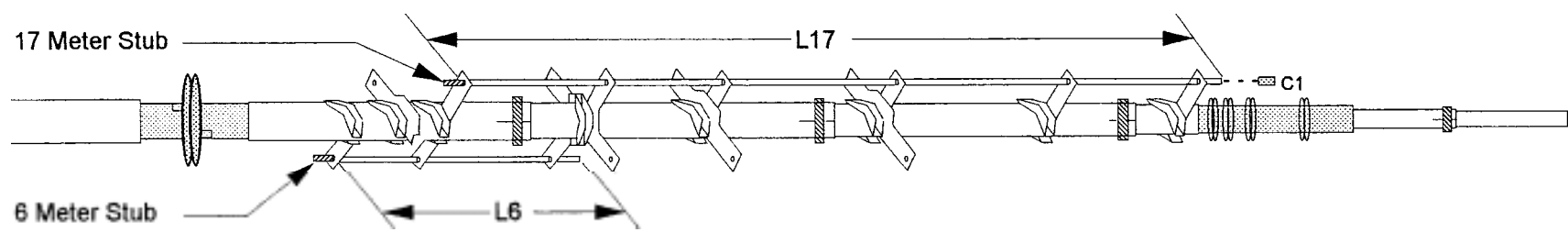
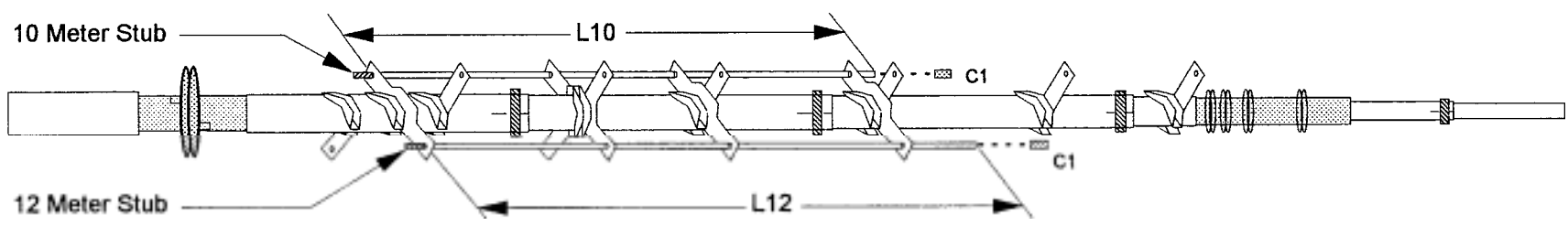
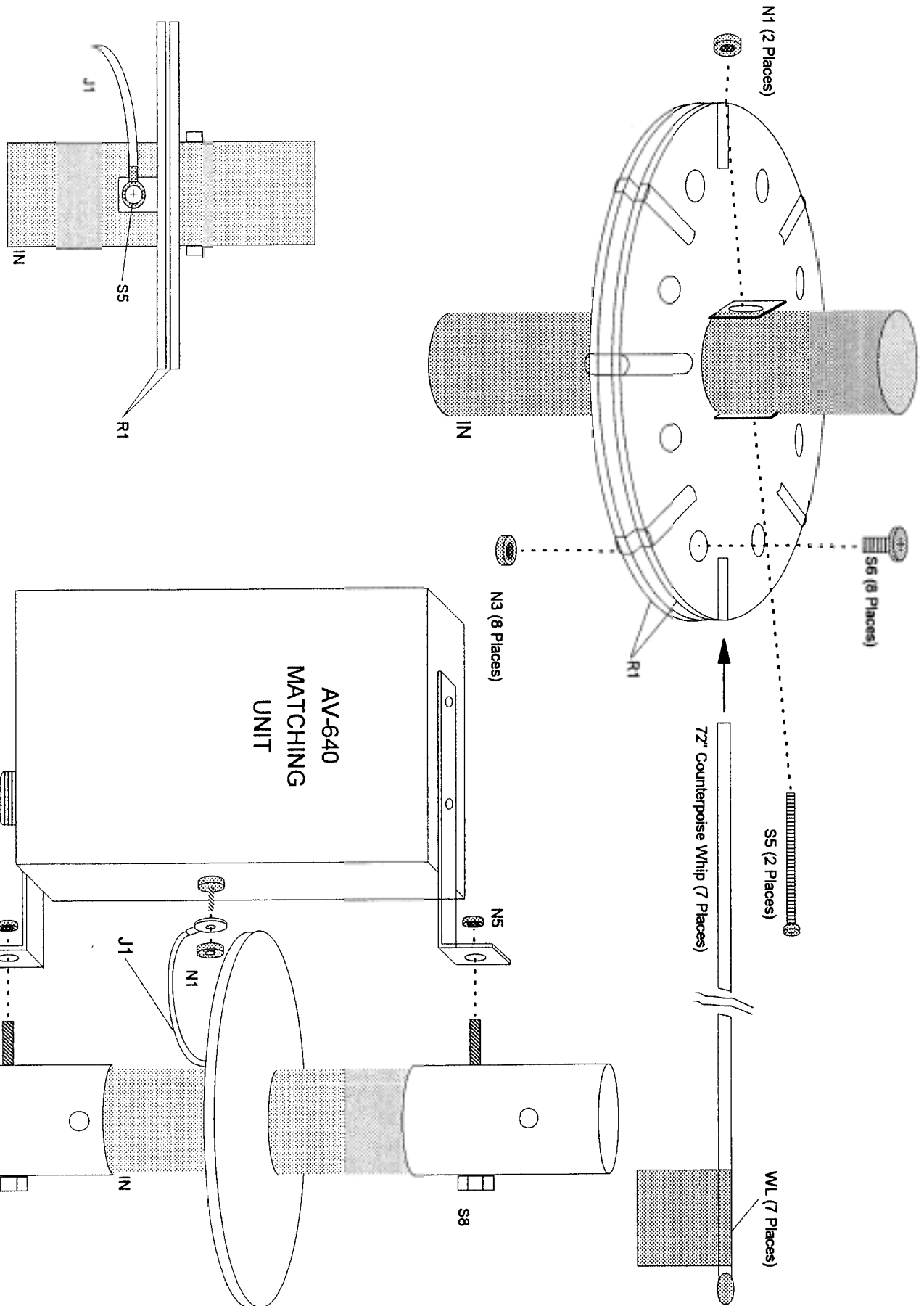

Figure G  
Stub Installation



**FIGURE H**  
**AV-640 Counterpoise Assembly**

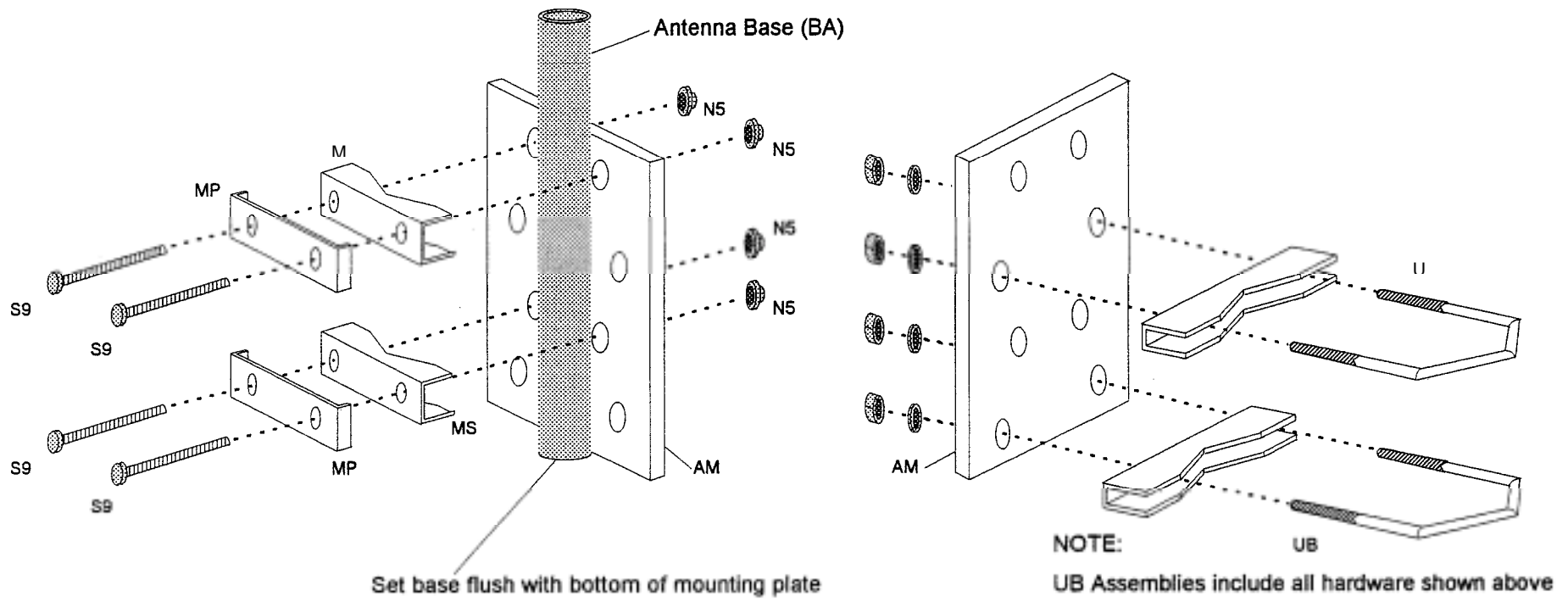
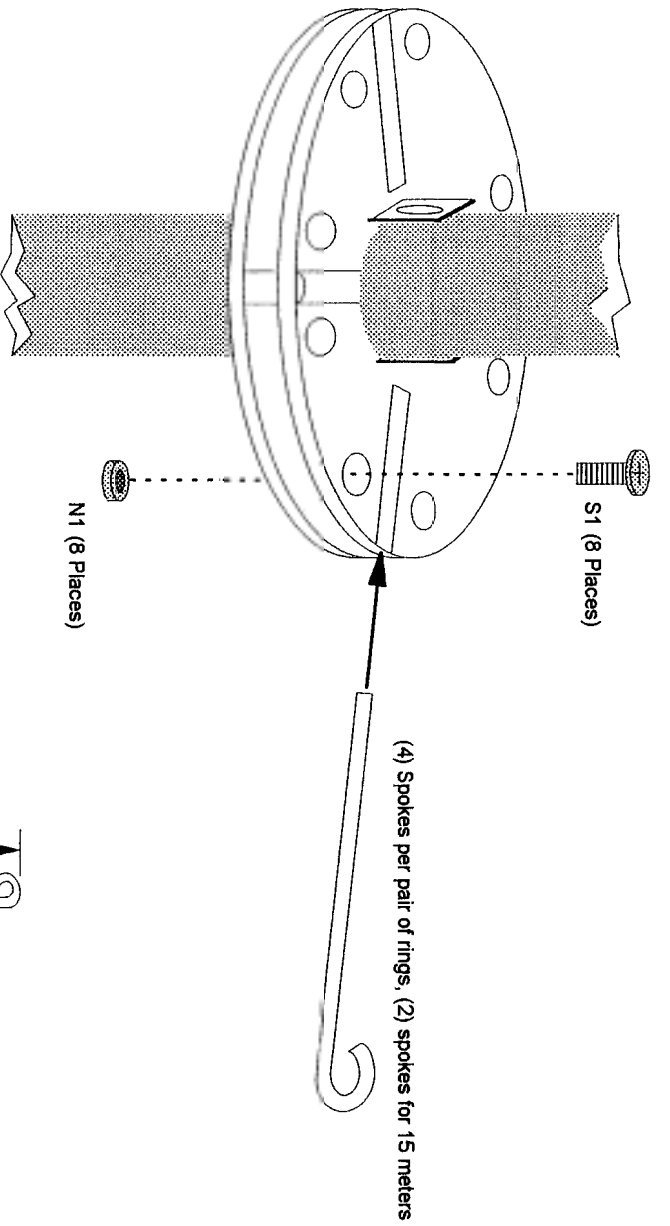
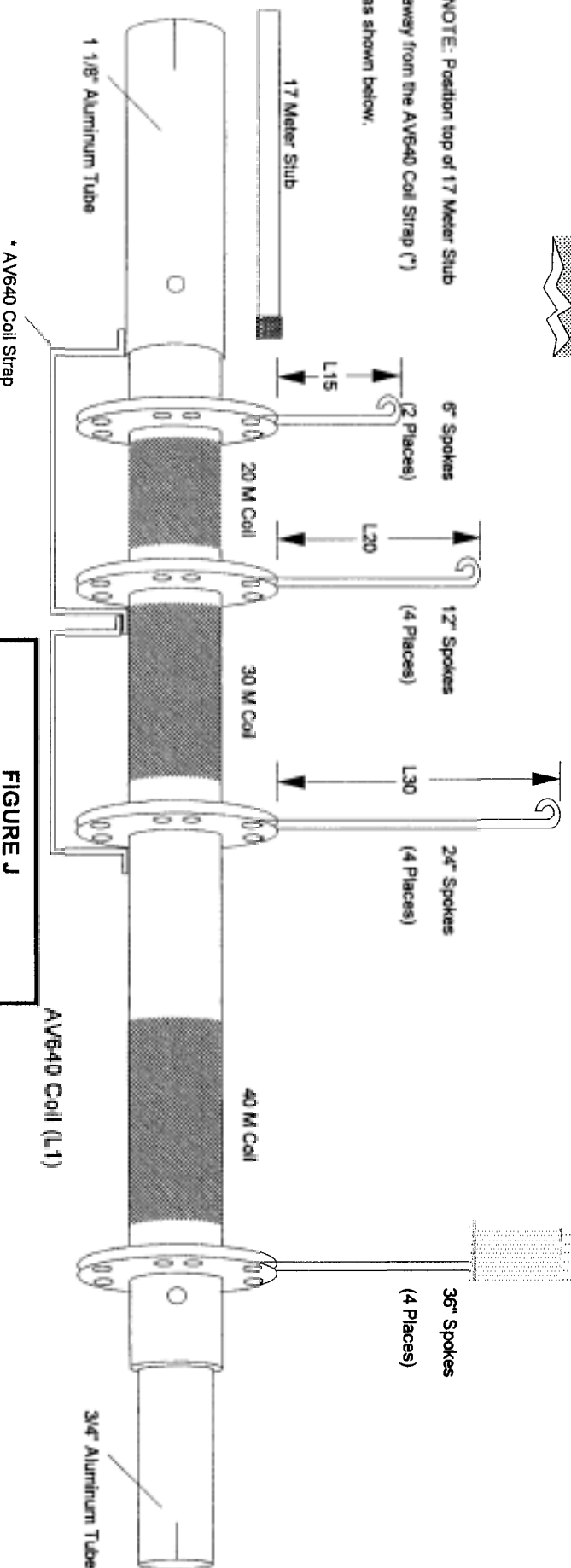

FIGURE I  
 AV-640 Antenna Mounting Plate Assembly



NOTE: Position top of 17 Meter Stub away from the AV640 Coil Strap (\*) as shown below.



**FIGURE J**  
**AV-640 Spoke Assembly**

## *hy gain*<sup>®</sup> 24-MONTH LIMITED

hy-gain Warrants to the original owner of this product, if manufactured by hy-gain and purchased from an authorized dealer or directly from by-gain to be free from defects in material and workmanship for a period of 24 months from date of purchase provided the following terms of this warranty are satisfied.

1. The purchaser must retain the dated proof-of-purchase (bill of sale, canceled check, credit card or money order receipt, etc.) describing the product to establish the validity of the warranty claim and submit the original or machine reproduction of such proof-of-purchase to by-gain at the time of warranty service. by-gain shall have the discretion to deny warranty without dated proof-of-purchase. Any evidence of alteration, erasure, or forgery shall be cause to void any and all warranty terms immediately.
2. hy gain agrees to repair or replace at hy-gain's option without charge to the original owner any defective product under warranty, provided the product is returned postage prepaid to hy-gain with a personal check, cashiers check, or money order for \$8.00 covering postage and handling.
3. Under no circumstances is by-gain liable for consequential damages to person or property by the use of any hy-gain products.
4. Out-of-warranty Service: by-gain will repair any out-of-warranty product provided the unit is shipped prepaid. All repaired units will be shipped COD to the owner. Repair charges will be added to the COD fee unless other arrangements are made.
5. This warranty is given in lieu of any other warranty expressed or implied.
6. hy-gain reserves the right to make changes or improvements in design or manufacture without incurring any obligation to install such changes upon any of the products previously
7. All by-gain products to be serviced in-warranty or out-of-warranty should be addressed **hy-gain, 308 Industrial Park Road, Starkville, Mississippi 39759, USA** and must be accompanied by a letter describing the problem in detail along with a copy of your dated proof-of-purchase.
8. This warranty gives you specific rights, and you may also have other rights which vary from state to state