

Simpson

INSTRUMENTS THAT STAY ACCURATE

OPERATOR'S MANUAL

**MODEL 479
FM-TV SIGNAL
GENERATOR**

SIMPSON ELECTRIC COMPANY

5200 W. Kinzie St., Chicago 44, Illinois. ES 9-1121

In Canada, Bach-Simpson, Ltd., London, Ontario



A.M. GENERATOR
400~ AUDIO GENERATOR
CRYSTAL CALIBRATOR

F.M. GENERATOR

FIG. 1. THE MODEL 479 TV-FM SIGNAL GENERATOR

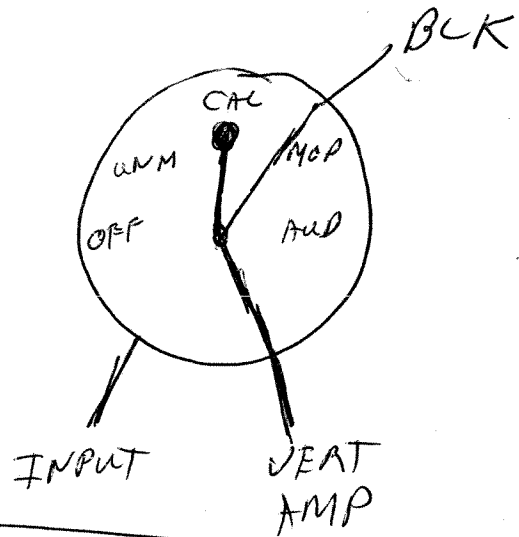

CAL POS
 VEAT AMP
 & BLK CONN

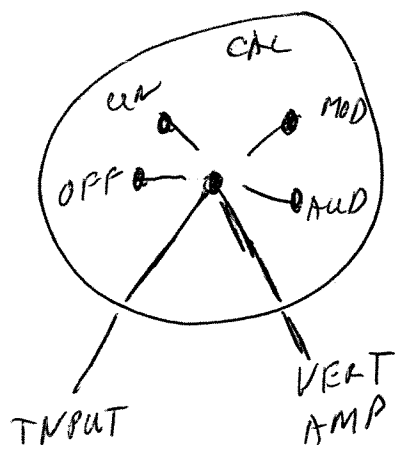

INPUT
 VEAT AMP
 EVERY POS EXP
 CAL

MODEL 479 FM-TV SIGNAL GENERATOR

The Simpson Model 479 Signal Generator has been designed carefully to supply all the necessary signal sources for the proper alignment and servicing of TV and FM receivers. For your convenience, markings on the FM Generator tuning dial allow you to tune it according to the frequency which you require, or according to television channel number for RF signals through both VHF and UHF ranges.

There are two separate tunable oscillator sections. Each oscillator section is provided with a large, precision vernier dial having a 20:1 knob-to-pointer ratio and a 1000 division logging scale. They are easy to read and easy to set to any exact frequency within the range of the generator.

Everything possible has been done to make the Model 479 the most accurate, flexible and convenient instrument available. Each part of this instrument has been considered carefully for long life and stability. Many of the vital components are manufactured under rigid supervision within our own plants in order to insure lasting accuracy and many years of uninterrupted service.

DESCRIPTION

The Model 479 is arranged in two major sections as shown in figure 1. The left hand section contains a crystal calibrator, a 400 cycle audio oscillator, and a three-range r-f generator which can be amplitude modulated with the output of the 400 cycle oscillator.

The desired type of signal is selected by the SIGNAL switch (left). The SIGNAL switch has five positions, named OFF, UNMOD. R.F., CAL., MOD. R.F., and AUDIO. When the switch is in the OFF position, the entire A.M. Generator is inoperative. When the switch is in the UNMOD. R.F. position, an unmodulated r-f signal is available through the OUTPUT jack and cable. The amplitude is controlled with the SIGNAL ATTENUATORS, with both fine and coarse adjustments (center and right). When the switch is in the CAL. position, the output of a 5.0 mc. crystal oscillator is mixed with the output of the R.F. Generator to produce a "beat" according to the information in table 1. The beat pattern can be observed on an oscilloscope connected with the VERT. AMPL. and HORIZ. AMPL. cables. By using table 1 and the oscilloscope, any frequency within the range of the instrument can be produced quickly and precisely. When the switch is in the MOD. R. F. position, the r-f signal is amplitude modulated 30% with a 400 cycle audio frequency and the modulated signal is available through the OUTPUT jack and cable. The amplitude is controlled by the SIGNAL ATTENUATORS. When the switch is in the AUDIO position, a 400 cycle signal is available through the OUTPUT jack and cable. The amplitude is controlled by the SIGNAL ATTENUATORS.

A potentiometer and a five-position switch together comprise the SIGNAL ATTENUATORS. The switch, at the right, is the coarse amplitude selector for the output of the a-m generator, and the potentiometer acts as a fine adjustment on amplitude.

The A.M. GENERATOR RANGE switch, located just below the center of the dial, selects each of the three bands of radio frequencies. The tuning knob varies the frequency throughout each band.

Band A.	Fundamental 3.3 to 7.8 mc. Second harmonic 6.6 to 15.6 mc.
Band B.	Fundamental 15 to 38 mc. Second harmonic 30 to 76 mc.
Band C.	Fundamental 75 to 125 mc. Second harmonic 150 to 250 mc.

The POWER switch (lower center) controls the power input to both sections of the Model 479. When the switch is in the OFF position the entire instrument is turned off. In the STAND BY position, all the tube filaments are turned on but no plate voltage is applied. In the OPERATE position, plate voltage is applied. The green light is on for both STAND BY and OPERATE positions of the switch, and the red light is on for the OPERATE position only.

In the center of the Model 479 there are three jacks which are labelled, from top to bottom, HORIZ. AMPL., VERT. AMPL., and SIGNAL INPUT. A cable from the HORIZ. AMPL. jack should be connected to the horizontal input terminal (with the red insulated clip) and ground (with the black insulated clip) of the oscilloscope used in conjunction with the Model 479. Set the function switch of the oscilloscope to utilize this signal for the horizontal sweep. The switch position will usually be named "horizontal amplifier" or "horizontal input" on the oscilloscope. This connection is important because it offers the operator his most convenient source of 60 cycle sine wave sweep voltage which may be phase adjusted relative to the f-m sweep voltage with the PHASING control on the Model 479. There is more information on this in the discussion of the PHASING control. A cable from the VERT. AMPL. is used to connect the source of the response pattern to the vertical input terminal (with the red insulated clip) and ground (with the black insulated clip) of the oscilloscope. A cable from the SIGNAL INPUT jack is used to connect the signal output of the amplifier under test back into the Model 479. This signal will be fed through the SIGNAL switch to the VERT. AMPL. jack when the switch is in the OFF, UNMOD. R.F., MOD. R.F., or AUDIO position.

The right hand section of the Model 479 contains a frequency modulated signal generator, a 140 mc. fixed frequency oscillator, a mixer, and phasing and blanking circuits. The output of the f-m signal generator is connected through an attenuator to the OUTPUT jack. The OUTPUT jack serves both the a-m and the f-m signal generators so that only one connection need be made to the input of the receiver.

The F.M. GENERATOR RANGE switch below the center of the dial has three positions. In the OFF position, the f-m generator section of the Model 479 is inoperative. In the A position, both the 140 mc. fixed frequency oscillator and the tunable f-m oscillator are operating; one output frequency from the mixer is the difference between these two frequencies. The fundamental range of the beat frequencies is 2 to 120 mc. The locations for RF signals for television channels 2 through 6 are marked in areas below the corresponding frequencies. In the B position, the switch turns off the 140 mc. fixed frequency oscillator, and the output from the variable frequency oscillator is available at the output. The fundamental range of the B band is 140 to 260 mc. The locations for RF signals for channels 7 through 13, which use fundamentals of the B band, are marked in areas below the corresponding frequencies. The locations of B band frequencies which will have harmonics required for RF signals for channels 14 through 83 are marked in groups above the B band. Channels 14 through 21 use second harmonics, 22 through 65 use third harmonics, and 66 through 83 use fourth harmonics. The tuning knob in the dial serves to select any frequency within the range indicated on the arcs of the CENTER FREQUENCY dial.

The F. M. ATTENUATORS are two controls which act as coarse and fine adjustments. A 5-position switch provides coarse control on attenuation and a continuously variable potentiometer provides the fine control.

The F.M. SWEEP control regulates the amount of frequency variation due to modulation. The center frequency of the fundamental can be swept through a band width of zero to 15 megacycles. Harmonics can be swept through multiples of this band width, corresponding to the harmonic order. The rate at which center frequencies are swept through any selected range and back is the modulation frequency of 60 cycles.

The PHASING control is a phase adjuster on the 60 cycle sine wave signal furnished to the HORIZ. AMPL. jack. It is to be used to adjust the phase relations between the oscilloscope sweep and the 60 cycle sweep modulation on the carrier. With the PHASING control it is possible to superimpose the response pattern on the forward trace over the pattern on the return trace.

The BLANKING control has a potentiometer and a switch on the same shaft. The switch is actuated at the full counter-clockwise knob position. When the knob is in the OFF position, no blanking occurs and the F.M. Generator oscillates continuously. When the knob is rotated toward its numbered range, the switch actuates and applies a 60 cycle voltage to the f-m oscillator grid to block out oscillations during its negative half cycles. Turning the BLANKING control through its numbered range changes the phasing of the blocking voltage with respect to the horizontal sweep to the oscilloscope. Thus either the forward or the return trace can coincide with the period of oscillation and the alternate trace can coincide with the time during which the oscillator is turned off. On the oscilloscope, the operator will see a single response curve with a base line through it.

Four cables are furnished for connecting the Model 479 to a receiver and to an oscilloscope. One cable fits in the OUTPUT jack and has a termination box at the other end which may be adapted quickly to the receiver input impedance with an optional 200 mmf capacitor in series for use on circuits having a d-c component. Most receiver inputs can be matched without using any external resistors or capacitors. See table 2 and figure 14. The other three cables are identical and are to be used in the HORIZ. AMPL., VERT. AMPL., AND SIGNAL INPUT jacks. A pair of clips at the other end of each cable are to be used for receiver output and oscilloscope connections. The red insulated clips connect the "hot" leads and the black insulated clips are for ground connections.

During normal alignment procedure, the signal is sent out of the OUTPUT jack, to the receiver under test, returned to the Model 479 through the SIGNAL INPUT jack, through the SIGNAL switch in any position except CAL., and out the VERT. AMPL. jack to the oscilloscope. This arrangement was designed to simplify the alignment operation by internal switching of the oscilloscope input. When the SIGNAL SWITCH is in the CAL. position, the signal fed to the VERT. AMPL. jack is the audio beat frequency produced by the a-m generator and the crystal calibrator near any of the calibration points listed in table 1.

CALIBRATION PROCEDURE FOR DETERMINING TUNABLE FREQUENCIES WITH CRYSTAL ACCURACY

The Model 479 has two precision vernier dials; one is used for the a-m generator and the other for the f-m generator. The a-m generator can be used as a marker generator for both FM and TV alignment. It needs to be extremely accurate to adjust FM and TV receivers properly. The basic accuracy is better than 1% (output frequency against dial indications), but it needs to be even more accurate for alignment. For this reason, the Model 479 is provided with a crystal oscillator standard having an accuracy of .05% or better. It is by use of this standard and the logging scale of the a-m generator that frequencies with crystal accuracy may be established at any point in the range of the a-m generator.

To prepare the Model 479 for calibration, turn the POWER switch to OPERATE; SIGNAL switch to CAL.; SIGNAL ATTENUATORS to a low setting; and the A.M. GENERATOR RANGE switch to A, B, or C depending on the frequency to be established. Connect the VERT. AMPL. cable to the vertical input of the oscilloscope. Connect the HORIZ. AMPL. cable to the horizontal input of the oscilloscope if a 60 cycle sine wave sweep is desired (calibration beats can be observed with either a 60 cycle sweep or linear sweep in the oscilloscope). With horizontal deflection on the oscilloscope due to

either the internal sweep or the 60 cycle sine wave sweep, advance the vertical amplifier gain of the oscilloscope and slowly rotate the a-m generator tuning knob while observing the oscilloscope screen. At various tuning points a pattern will appear on the oscilloscope screen. Rotate the dial slowly through the area in which a pattern can be seen. First a high frequency appears, then as the knob is rotated slowly, note that the frequency reduces to zero, then increases to a high frequency again and disappears. The patterns are the results of beat frequencies developed between the a-m oscillator and the 5.0 mc crystal oscillator.

The point at which the pattern reduces to zero frequency is known as zero beat and is the point at which the two oscillators are in step. The zero beat point is identified easily by the fact that the slightest movement of the dial in either direction will cause the pattern to increase in height and in frequency. At zero beat the pattern is, essentially, a straight line. At the higher frequencies it is sometimes difficult to bring the pattern down to exact zero beat, but this is not important so long as it is brought down to within two or three hundred cycles. This shows three to five cycles on a 60 cycle sweep.

Note that some points on the dial will produce much larger patterns than others. This is due to the order of harmonics of the two oscillators producing the beat pattern. The lower harmonics result in a stronger beat pattern. Some of the weaker patterns may require a higher setting of the vertical gain control of the oscilloscope.

Table 1 has been developed to assist the operator in identifying the frequencies where beat patterns occur and the oscillator harmonics which produce them. The frequencies preceded by an asterisk (*) will produce the stronger patterns and should be used wherever possible.

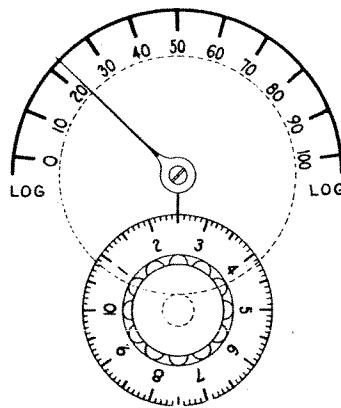

FIG. 2. THE MODEL 479 AM-FM LOGGING DIAL

Figure 2 is an illustration of the logging arcs as they are used in both a-m and f-m generator dials. The upper arc of each dial is divided into 10 equal divisions marked from 0 to 100. On the knob shaft is another dial marked in 100 equal divisions. The gear ratio between the knob shaft and the pointer is such that one revolution of the knob shaft moves the pointer through one of its ten divisions. Thus each division of the logging scale is effectively divided into 100 parts and the entire arc into 1000 parts. The minor divisions may be divided visually for further increasing the number of logging points and the resulting accuracy of calibration information. For example, the reading on the logging scale in figure 2 is 22.5. The main pointer shows that the setting is 20 plus some additional amount, and the dial on the knob shaft shows that the additional amount is 2.5. If the knob were turned slightly counterclockwise so the dial setting were half way between 2.5 and 2.6, it could be read as 2.55 and the indicated setting would be 22.55 divisions. Take advantage of the visual division of these marked points and effectively increase the accuracy to 2000 or more scale divisions.

TABLE I - CRYSTAL CALIBRATING POINTS

BAND A				BAND B				BAND C			
FUNDAMENTAL MEGACYCLES	2ND HARMONIC MEGACYCLES	VAR. OSC. HARM.	XTL. OSC. HARM.	FUNDAMENTAL MEGACYCLES	2ND HARMONIC MEGACYCLES	VAR. OSC. HARM.	XTL. OSC. HARM.	FUNDAMENTAL MEGACYCLES	2ND HARMONIC MEGACYCLES	VAR. OSC. HARM.	XTL. OSC. HARM.
*3.33	*6.67	3	2	*15.00	*30.00	1	3	*70.0	*140	1	14
3.46	6.92	13	9	15.83	31.66	6	19	72.5	145	2	29
3.50	7.00	10	7	16.00	32.00	5	16	*75.0	*150	1	15
3.57	7.14	7	5	16.25	32.50	4	13	77.5	155	2	31
3.64	7.28	11	8	*16.67	*33.34	3	10	*80.0	*160	1	16
*3.75	*7.50	4	3	17.00	34.00	5	17	82.5	165	2	33
3.89	7.78	9	7	*17.50	*35.00	2	7	*85.0	*170	1	17
*4.00	*8.00	5	4	18.00	36.00	5	18	87.5	175	2	35
4.09	8.18	11	9	*18.33	*36.66	3	11	*90.0	*180	1	18
*4.17	*8.34	6	5	18.75	37.50	4	15	92.5	185	2	37
4.29	8.58	7	6	19.00	38.00	5	19	*95.0	*190	1	19
4.38	8.76	8	7	*20.00	*40.00	1	4	97.5	195	2	39
*4.44	*8.88	9	8	21.00	42.00	5	21	*100.0	*200	1	20
4.50	9.00	10	9	21.25	42.50	4	17	102.5	205	2	41
4.55	9.10	11	10	*21.67	*43.34	3	13	*105.0	*210	1	21
4.58	9.17	12	11	22.00	44.00	5	22	107.5	215	2	43
*5.00	*10.00	1	1	*22.50	*45.00	2	9	*110.0	*220	1	22
5.63	11.26	8	9	23.00	46.00	5	23	112.5	225	2	45
*5.71	*11.42	7	8	*23.33	*46.66	3	14	*115.0	*230	1	23
5.83	11.66	6	7	23.75	47.50	4	19	117.5	235	2	47
6.00	12.00	5	6	24.00	48.00	5	24	*120.0	*240	1	24
*6.25	*12.50	4	5	*25.00	*50.00	1	5	122.5	245	2	49
6.43	12.86	7	9	26.25	52.50	4	21	*125.0	*250	1	25
*6.67	*13.34	3	4	26.67	53.34	3	16				
6.87	13.74	8	11	*27.50	*55.00	2	11				
*7.00	*14.00	5	7	28.33	56.66	3	17				
7.14	14.28	7	10	28.75	57.50	4	23				
7.22	14.44	9	13	*30.00	*60.00	1	6				
*7.50	*15.00	2	3	31.67	63.34	3	19				
7.72	15.44	11	17	*32.50	*65.00	2	13				
				33.33	66.66	3	20				
				*35.00	*70.00	1	7				
				36.67	73.34	3	22				
				*37.50	*75.00	2	15				

ASTERISK (*) INDICATES THE STRONGER CALIBRATION POINTS.

DETERMINING AN EXACT FREQUENCY

There are two methods by which a given frequency setting may be obtained. They are somewhat similar but one is simpler, while the other yields more accurate results.

The first method is the simpler and, with practice, can produce acceptable results for most purposes. The process consists of first determining the number of logging scale divisions which correspond to a one megacycle frequency difference which includes the desired frequency; second, mathematically figuring the number of logging scale divisions the desired frequency is away from a crystal check point (see table 1); third, turning to the crystal point and observing its logging scale reading; and fourth, adding or subtracting the determined number of scale divisions to or from the reading at the crystal check point. When the logging scale is set to the reading obtained in the fourth step, the oscillator will be tuned to the desired frequency.

A step-by-step example of the first method follows. Assume that a frequency of 20.75 mc. is desired in the A.M. Generator. Note that table 1 shows a strong calibration check point at 20 mc. Set the A.M. GENERATOR RANGE switch to B, the SIGNAL switch to CAL., and the SIGNAL ATTENUATORS low to see the zero beat indications on an oscilloscope with the VERT. AMPL. and HORIZ. AMPL. cables connected. Have the POWER switch in either STAND BY or OPERATE position for at least 15 minutes before beginning the calibration to allow the Model 479 to warm up, and set it in the OPERATE position to calibrate.

1. Observe the tuning arc of range B from a position directly in front of the pointer (to avoid parallax error) and set the pointer over the 20 megacycle mark on the dial. Record the logging scale reading for this setting. On a sample unit the setting was 36.0 (use your readings, since there will be variation from one unit to another which does not affect the accuracy in any way). Set the pointer exactly over the 21 megacycle mark on the dial. Again record the logging scale reading. The sample unit read 40.45 for this setting. Subtract the first reading from the second to obtain the number of scale divisions which correspond to one megacycle. $40.45 - 36.0$ is 4.45 divisions.

2. Determine the frequency difference, in megacycles, between the desired frequency and a check point (table 1); then multiply this difference by the result of step 1 above. In the example, the desired frequency of 20.75 mc. is .75 mc. away from the strong calibration check point at 20 mc. The result of step 1 shows that in this area of the sample unit, a change of 4.45 scale divisions corresponds to a change of one megacycle. Multiply $.75 \times 4.45$ to get 3.33 divisions.

3. With the aid of the oscilloscope, tune the generator to its zero beat position for the chosen calibration check point and record the logging scale setting for this position. In the example, the sample unit was tuned to 20 megacycles and the logging scale read 36.2 divisions.

4. Add or subtract the results of steps 2 and 3. Add if the check point frequency is lower than the desired frequency, or subtract if the check point frequency is the higher. This sum or difference is the logging scale setting to use for the desired frequency. In the example, add (because the check point is below 20.75 mc.) 3.33 to 36.2 to obtain 39.53 divisions.

Note that the logging scale readings are for a sample unit only. Do not use these readings. Obtain the logging scale readings for your Model 479 and use them in a similar way. Although you will be using some frequency settings repeatedly, do not rely on the stability of the instrument over long periods of time; the components are subject to normal deterioration and will cause slight changes of logging scale settings in time.

The second method is different from the first only in the fact that two crystal check point settings are used in place of two dial markings. First, determine the number of logging scale divisions which correspond to the frequency difference between two crystal check points surrounding the desired frequency; second, mathematically figure the number of logging scale divisions the desired frequency is away from one of the check point frequencies; third, add or subtract the determined number of scale divisions to or from the reading at the crystal check point. Add if the lower check point is the reference, or subtract if the higher check point is the reference. When the logging scale is set to the reading obtained in the third step, the oscillator will be tuned to the desired frequency. The accuracy obtained by this method is better than 0.1%.

A step-by-step example of the second method follows. Again, assume that a frequency of 20.75 mc. is desired in the A.M. Generator. Note that the two nearest strong crystal check points are 20.0 and 21.67 mc. (table 1). There are weak check points at 21.0 and 21.25 mc., but these are not recommended because they are close together and difficult to identify. Set the A.M. GENERATOR RANGE switch to B, the SIGNAL switch to CAL., and the SIGNAL ATTENUATORS low to see the zero beat indications on an oscilloscope with the VERT. AMPL. and HORIZ. AMPL. cables connected. Have the POWER switch in either STAND BY or OPERATE position for at least 15 minutes before beginning the calibration to allow the Model 479 to warm up, and set it in the OPERATE position to calibrate.

1. With the aid of the oscilloscope, tune the A.M. GENERATOR around the 20 megacycle point for the zero beat indication. Record the logging scale setting for the zero beat position. On the sample unit, the reading was 36.2 divisions (use the reading on your own Model 479; this is for an example only). Retune the A.M. Generator around the 21.67 mc. point for the zero beat indication. Record the logging scale setting for this zero beat position. On the sample unit, the reading was 43.3 divisions. Subtract the first reading from the second for the number of logging scale divisions between the check point frequencies. For the example, 43.3-36.2 is 7.1 divisions.

2. Determine the frequency difference between the desired frequency and either check point frequency. In the example, the desired frequency (20.75 mc.) is .75 mc. above the lower check point and is .92 mc. below the upper check point. Next find the frequency difference between the two check points. In the example this is 1.67 megacycles. By ratio and proportion, the frequency deviations can be translated into scale divisions for the logging scale;

$$\frac{D_1}{D_2} = \frac{F_1}{F_2} \quad \text{or} \quad D_1 = D_2 \left(\frac{F_1}{F_2} \right)$$

where D_1 = logging scale divisions between one check point and the desired frequency,

D_2 = logging scale divisions between two check points,

F_1 = frequency difference between the same check point (see D_1 above) and the desired frequency,

and F_2 = frequency difference between the two check points.

In the example, using the .75 mc. deviation from 20 megacycles,

$$D_1 = 7.1 \left(\frac{.75}{1.67} \right) = 3.19 \text{ divisions.}$$

3. If the lower check point was used to determine D_1 (in step 2), add D_1 to the logging scale setting for this check point; or if the higher check point was used to determine D_1 (in step 2), subtract D_1 from the logging scale setting for this check point. The result will be the logging scale setting for the desired frequency. In the example, add 3.19 to 36.2 to get 39.39 divisions which is a very accurate setting to obtain 20.75 mc. on the sample unit.

Use table 3 at the back of the manual to record the settings for the various frequencies after they have been determined. This will save time whenever the use of any frequency is repeated. Note that four columns apply to each frequency listed: the first column will contain the desired frequency; the second column will have the log scale setting which has been determined for the desired frequency; the third column will have the nearest crystal check point frequency; and the fourth column will have the log scale setting of the crystal check point. To use, after it has once been filled in for any given frequency, zero beat the crystal check point frequency and compare the reading of the logging scale against the listed setting of the fourth column. If the readings are identical, tune to the logging scale setting of the desired frequency listed in the second column and you will have tuned the oscillator to the desired frequency. However, if there is a difference between the log scale setting for zero beat at the check point and the listed setting in the fourth column, it indicates that the components of the oscillator have changed, and the logging scale settings need correction. If the log scale setting for the crystal check point has changed up or down one, two, or three divisions, the setting for the desired frequency has changed the same number of divisions in the same direction so add or subtract the change to or from the column 2 listing to provide a corrected setting. There is enough space in both the second and fourth columns to keep a record of any changes over a long period of time. For greater accuracy, if the scale settings change more than five divisions, recalculate the column 2 listing rather than add or subtract divisions.

PRINCIPLES OF VISUAL ALIGNMENT

The visual method of adjusting resonant circuits has been developed in order to eliminate the tedious procedure of point to point measurements which would otherwise be necessary to determine the response characteristics of a tuned circuit or a number of tuned circuits such as used in radio and television receivers.

Referring to figure 3 it is obvious that a response curve can be traced by applying a signal of fixed amplitude to the input of the circuit and measuring the output voltage as the frequency of the generator is varied. This, of course, requires numerous measurements and is impractical for the purpose of circuit adjustment. The visual alignment procedure accomplishes the same result but is instantaneous. Here the generator frequency is varied above and below circuit resonance at a fixed rate.

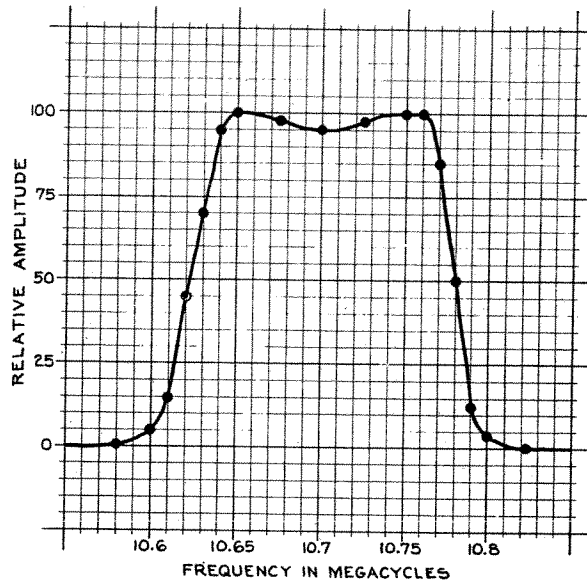

FIG. 3. GRAPHIC REPRESENTATION OF A RESPONSE CURVE

The vertical amplifier of an oscilloscope is connected across the output of the circuit in order to indicate the instantaneous voltage appearing at various points along the curve and the oscilloscope sweep is synchronized with the generator frequency deviation in such a manner that the entire resonant characteristic of the circuit is registered on the oscilloscope screen.

By this method the operator can see instantly the effects of the adjustments as he proceeds with the alignment.

This type of alignment is of particular value in television receivers because of the wide band characteristics necessary for satisfactory reception.

ALIGNMENT PROCEDURE

It would be impossible to cover all of the various alignment procedures in this manual since each receiver manufacturer determines the sequence of adjustment best suited to his particular product. Follow the receiver manufacturer's service instructions when making tests and adjustments on a television receiver.

The following paragraphs will explain the various steps in the alignment of a typical receiver and may be used as a guide for adapting the Model 479 and an associated oscilloscope to any manufacturer's specific instruction.

The general procedure is as follows:

1. Connect the Model 479 to a 110 volt 60 cycle power outlet.
2. Turn the POWER switch to the OPERATE position.
3. Connect the receiver to a power outlet and turn it on. Adjust the contrast control to approximately $\frac{3}{4}$ of maximum. Some receivers require a battery bias to simulate normal AGC.
4. Allow the receiver and the Model 479 to warm up for about 15 minutes before attempting to make any adjustments. (The Model 479 will not require additional warm up time if the POWER switch has been left in the STAND BY position.)

5. Connect the HORIZ. AMPL. cable to the horizontal input terminals of the oscilloscope, and the VERT. AMPL. cable to the vertical amplifier input.

6. Set the oscilloscope switches and controls as follows: vertical sensitivity high, vertical gain at 0, horizontal gain as required to obtain a convenient horizontal deflection on the cathode ray tube, and function switch to the position which will connect the horizontal input through the horizontal amplifier.

7. Advance the oscilloscope intensity control and focus control until a thin bright horizontal line is seen on the cathode ray tube. Center the trace horizontally and vertically.

8. On the Model 479, set the controls as follows:

F.M. GENERATOR RANGE switch at OFF; A.M. GENERATOR RANGE switch to B; SIGNAL switch to CAL., and SIGNAL ATTENUATORS low.

9. Advance the oscilloscope vertical gain control to about mid rotation and re-adjust as desired during the following steps.

10. Refer to the receiver manufacturer's literature for the frequencies which will be required during the adjustment. Determine the logging scale settings to tune these frequencies; use the instructions given under CALIBRATION PROCEDURE in this manual. The frequencies specified for this example of a typical circuit are; 19.75, 21.25, 21.8, 22.3, 23.4, 25.2, 25.3, and 27.25 mc. See figure 4. A new tendency among receiver manufacturers is to use an intermediate frequency centered around 45 mc.

11. Set the OUTPUT cable termination for 75 ohms by jumpering terminals 6-7-8-9-5 and terminals 2-3-4. (Open termination may be preferred. See table 2 for instructions.) Connect the alligator clip on the end of the probe to point "F" of figure 4. Connect the ground lead of the probe to the receiver chassis. Note that the alligator clip and ground lead may provide too much inductance for use at 45 mc. See the special instructions on page 24. Connect the SIGNAL INPUT cable to point "A" of figure 4.

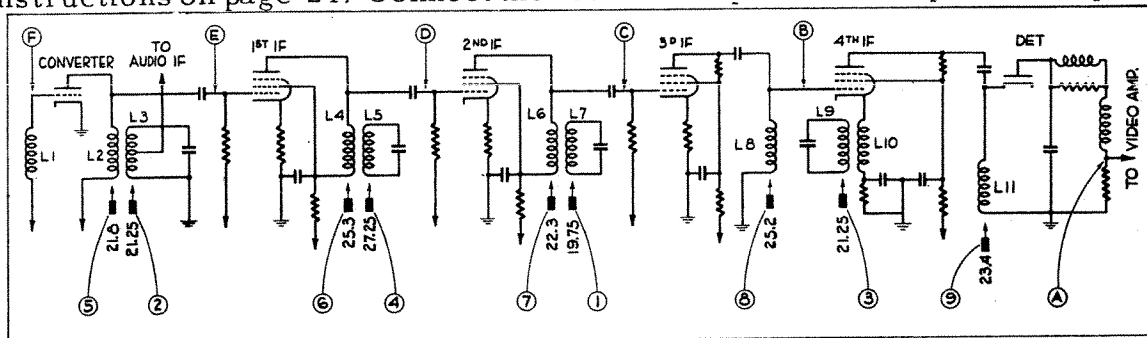

FIGURE. 4. TYPICAL TV VIDEO IF SYSTEM

12. Rotate the SIGNAL switch to MOD. R.F. and adjust the SIGNAL ATTENUATORS and the oscilloscope vertical gain control until a good size Lissajou pattern is seen on the oscilloscope. The SIGNAL ATTENUATORS should be operated at the lowest setting which will give a good oscilloscope pattern.

13. Set the A. M. GENERATOR logging scale to the point recorded for 19.75 megacycles and adjust L7 (point "1" of figure 4) for minimum pattern height. If the pattern disappears completely, increase the attenuator setting until the exact minimum point can be observed.

14. Set the logging scale at the point recorded for 21.25 mc. and adjust the sound

takeoff trap L3 (point 2) for a minimum indication.

15. Leave the Model 479 set at 21.25 mc. and adjust the accompanying sound trap L9 (point 3) for a minimum indication.

16. Set the logging scale to the point recorded for 27.25 mc. and adjust the adjacent channel sound trap L5 (point 4) for a minimum indication. This completes the trap adjustments.

17. Set the logging scale at the point recorded for 21.8 mc. and adjust the converter output L2 (point 5) for a *MAXIMUM* indication. If the pattern becomes too large, reduce the SIGNAL ATTENUATORS.

18. Set the logging scale to the point recorded for 25.3 mc. and adjust the first IF L4 (point 6) for maximum.

19. Set the logging scale to the point recorded for 22.3 mc. and adjust the second IF L6 (point 7) for maximum.

20. Set the logging scale to the point recorded for 25.2 mc. and adjust the third IF L8 (point 8) for maximum.

21. Set the logging scale to the point recorded for 23.4 mc. and adjust the third IF L11 (point 9) for maximum.

22. If coils L2, L4, and L6 have required appreciable adjustment, the associated traps, L3, L5, and L7 should be rechecked as explained in steps 13, 14, and 16.

23. Occasionally a receiver will have a tendency to oscillate during alignment. Usually this is caused by two or more transformers being tuned to the same frequency. Such oscillation will be identified by a sudden high deflection on the CRT and a scrambled pattern which cannot be controlled by the attenuators. When this occurs, the best remedy is to shunt points C, D, E, and F with .001 mfd capacitors. Connect the Model 479 OUTPUT cable to point B and adjust L11. Remove the capacitor at point C and connect the OUTPUT CABLE to this point and adjust L8. Repeat this process for each stage back to point F, removing the capacitor and connecting the OUTPUT cable to points D, E, and F. Adjust L6, L4, and L2 for maximum indications. Some manufacturers recommend the latter, or backwards, sequence of adjustment. It makes little difference which sequence is used as long as each stage is adjusted carefully to its assigned frequency. This completes the i-f adjustments.

24. Leave the OUTPUT cable of the Model 479 connected to the converter grid (point F) and the SIGNAL INPUT cable connected across the video detector load resistor (point A).

25. Set the SIGNAL switch to the OFF position. Set the F.M. GENERATOR RANGE switch to A, F. M. ATTENUATOR switch to MAX. and potentiometer to 5, PHASING to 0, and BLANKING to OFF. Tune the F.M. GENERATOR to approximately 23 mc. on range A. A response curve of the i-f system will appear on the oscilloscope. Adjust the F.M. Attenuators and the oscilloscope vertical gain for a pattern of convenient height, keeping the F. M. ATTENUATORS set as low as possible. Adjust the PHASING control to superimpose the two traces. Readjust the tuning dial until the pattern is centered in the horizontal trace. Readjust the F.M. SWEEP control until the pattern includes about two-thirds of the horizontal trace. Correct the control for superimposed traces again. Rotate the BLANKING control to produce a base line through a single trace.

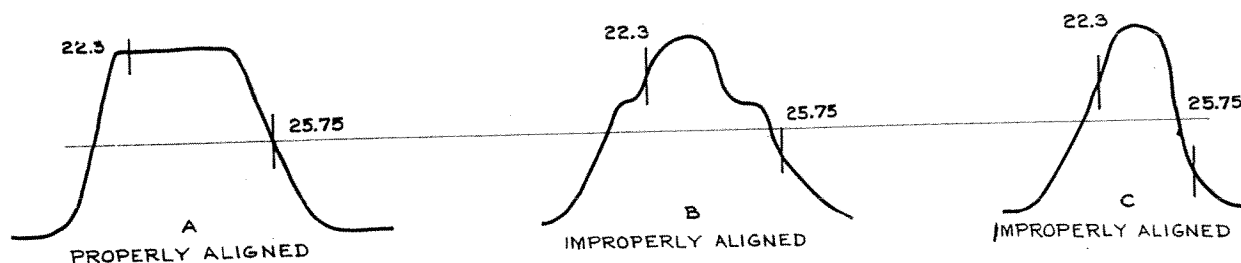

FIG. 5. PICTURE IF RESPONSE - STAGGER TUNED

26. Compare the pattern with the one shown in the manufacturer's instructions. Figure 5 shows an example of an i-f response curve. If the system has been aligned properly, it should resemble figure 5A.

27. Turn the SIGNAL switch to UNMOD. R.F. and set the logging scale of the A.M. Generator to the point for 22.3 mc. A marker should appear on the pattern as shown at the left in figure 5 A, B, and C. Adjust the SIGNAL ATTENUATORS and the F.M. ATTENUATORS for the desired balance of signal strengths. If the marker signal is too strong, the curve will be distorted and it will be difficult to measure its exact position on the pattern.

28. Set the logging scale to the point recorded for 25.75 mc. and check the position of the marker. It should appear at 50% of the maximum pattern height. Setting the marker frequency to the various points to which the system was adjusted will indicate the part of the response curve affected by each adjustment. Slight re-adjustment of the system may be performed at these points in order to produce a satisfactory response curve. However, if considerable adjustment is necessary, the entire alignment procedure should be repeated.

The foregoing paragraphs have dealt with the alignment of a stagger tuned video i-f system. Another system, known as Band Pass IF and used in many receivers, requires that the entire alignment be performed by use of the F.M. Generator. In this type of receiver, alignment begins with the last i-f stage and proceeds stage by stage back to the converter. A set of curves is furnished as a guide and it is only necessary to follow the sequence set up by the manufacturer's instructions, using his curves to indicate the type of response to be expected. A set of sample curves appears in figure 6.

To adjust band pass i-f, connect the SIGNAL INPUT cable to the video detector output and the OUTPUT cable to the grid of the last i-f amplifier. Set the F.M. GENERATOR RANGE switch to A and adjust the dial to 25 mc. Set the F.M. ATTENUATORS to MAX. and 10, and adjust PHASING and BLANKING controls and the associated oscilloscope for a single image pattern with satisfactory height. Set the A.M. GENERATOR RANGE switch to B and the SIGNAL switch to CAL. Record logging scale readings for the recommended frequencies. In the example, these are 22.6, 22.75, 23.25, 23.75, 24.25, 24.6, 25.75, 26.6, 26.75, 27.0, and 27.1 megacycles. Set the SIGNAL switch to UNMOD. R.F. and the logging scale to the point recorded for 27.1 megacycles. Adjust the SIGNAL ATTENUATORS to the lowest setting which will give a satisfactory marker on the trace. Adjust the last i-f transformer primary and secondary for a single peak centered on the 27.1 mc. marker. Set the A.M. Generator logging scale to the position for 23.25 mc. Adjust the coupling condenser in the last i-f transformer for a peak centered at 23.25 mc. The curve should now resemble figure 6A.

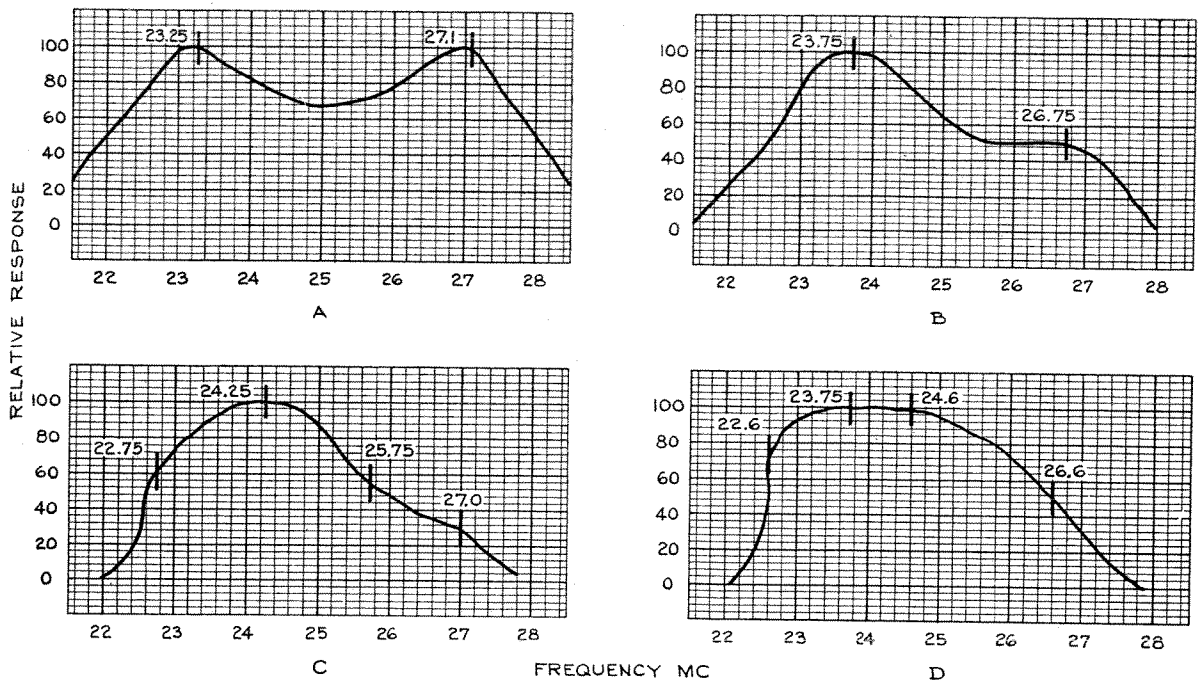

FIG. 6 VIDEO ALIGNMENT CURVES - BAND PASS TYPE

Move the OUTPUT cable to the grid of the preceding stage. Adjust the secondary of this i-f transformer for a peak at 23.75 mc. and the primary for a peak at 26.75 mc. There is no coupling condenser adjustment for this stage. The response curve should now resemble figure 6B.

Move the OUTPUT cable to the next preceding stage. Adjust the primary and secondary of the i-f transformer for a curve having the same shape and relative amplitude as that of figure 6C. Use the marker at the frequencies indicated: 22.75, 24.25, 25.75, and 27.0 mc.

Move the OUTPUT cable to the grid of the converter. Adjust the primary, secondary, and coupling condenser of the first i-f transformer for a curve having the same shape and relative amplitude as figure 6D. The check points indicated for marker use are 22.6, 23.75, 24.6, and 26.6 megacycles.

Touch up adjustments are permissible to improve the over-all response curve. Be careful to select the adjustment which affects the part of the curve which needs correction. Figure 7 shows the acceptable limits of the over-all response curve with the amplitude at 24.0 mc. for a reference point. Conduct the alignment to produce a curve which is within these tolerances.

The last five paragraphs have outlined a typical process for band pass i-f alignment only. For trap adjustments, see steps 10 to 16 on page 12. The trap adjustments should be made in the order recommended by the receiver manufacturer, with the F.M. GENERATOR RANGE switch in the OFF position and the SIGNAL switch in the MOD. R.F. position. Log the specified trap frequencies in advance.

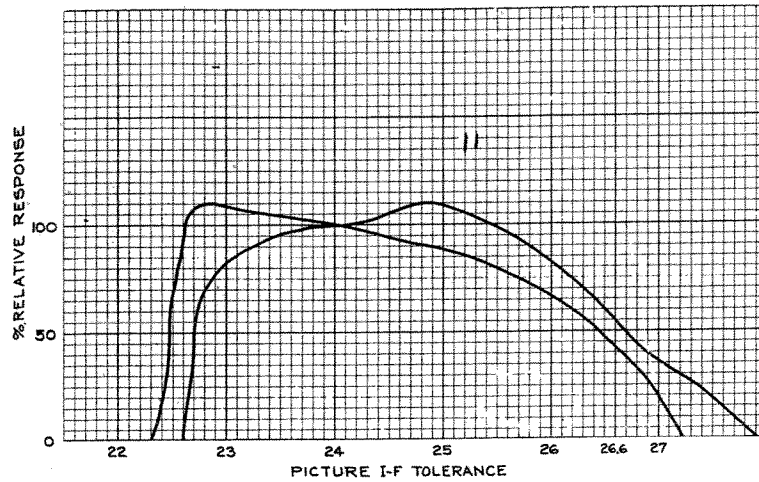

FIGURE 7. RESPONSE TOLERANCE - BAND PASS I-F

A third type of circuit uses what is known as intercarrier i-f. The principle is to provide a mixer and oscillator to produce an intermediate frequency, and to amplify this i-f through several stages with a special frequency response characteristic; the band pass is sufficient to include both the sound and the video center frequencies, and the response maintains a desired relative amplitude between the two center frequencies. Then the beat of 4.5 megacycles between the two center frequencies is used to produce a double superheterodyne action with the sound frequency modulated on the 4.5 mc. carrier. The sound i-f (usually one stage), tuned to 4.5 mc., amplifies the sound signal and sends it to an f-m demodulator of any type desired by the manufacturer. It is important to follow the alignment data indicated in the manufacturer's literature because he has engineered a circuit which requires specific response characteristics, and no generalization could represent the large variety of possibilities. The receiver manufacturer's literature will indicate where the test points are located, what frequency to use for each input, what adjustment can be made, and the resulting response wave shape. Set up the Model 479 in accordance with general instructions and use an oscilloscope to observe the results. Use the 60~ sweep available through the HORIZ. AMPL. cable to observe the response curve in phase with the frequency modulating signal.

Sometimes during alignment it is desirable to have two markers at different frequencies on the response curve at the same time. A second signal generator, unmodulated, is necessary, tunable to the frequency at which the marker is desired. The second generator can be calibrated with the accuracy of the Model 479 and should be as stable as possible. To calibrate the second generator, set up the Model 479 for its normal alignment procedure, with the OUTPUT feeding into a receiver and the receiver output connected to the SIGNAL INPUT cable. Connect the VERT. AMPL. and HORIZ. AMPL. cables to the input terminals of the associated oscilloscope. Establish the marker on the response curve at the frequency to which the second generator will be tuned. Then couple the second signal generator output across the termination box or in any other convenient way to the receiver input. Sometimes the mere presence of the second generator on the test bench will provide sufficient coupling without any direct connections. Now tune the second signal generator for a beat indication with the marker from the accurately calibrated A.M. Generator in the Model 479. Tune the second generator for a zero beat indication of the two markers. Then change the setting of the Model 479 A.M. Generator to provide the second marker frequency. Both markers will show on the single response curve.

F-M RECEIVER ALIGNMENT

The order of f-m alignment usually begins with the discriminator adjustment; the i-f section is next and the r-f section is last. If the receiver manufacturer recommends some other sequence, use his suggestions rather than these general instructions. The

information in the following paragraphs is for the sound section of a television receiver, but the same principles apply to f-m receivers except that their intermediate frequencies are usually lower.

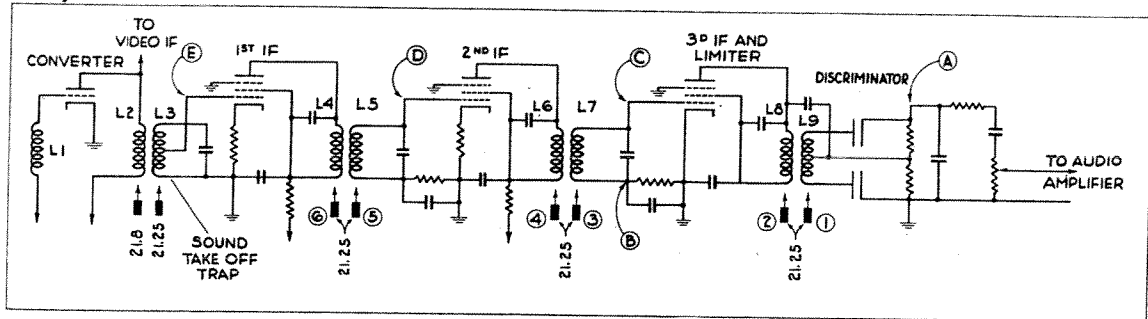

FIG. 8. TYPICAL TV SOUND IF SYSTEM

DISCRIMINATOR ALIGNMENT

Figure 8 is the schematic diagram of a typical sound i-f system composed of three i-f amplifier stages and a discriminator. The third i-f stage acts as a limiter to reduce the effects of amplitude modulation. Usually the alignment will begin at the discriminator and work back, stage-by-stage, to the converter. Proceed as follows:

1. Connect the HORIZ. AMPL. cable and the VERT. AMPL. cable to the input terminals of the associated oscilloscope.
2. Connect the Model 479 OUTPUT cable between point "C" and ground (see figure 8). Use any desired termination. See table 2 for data on the termination box connections. Use the series condenser (do not jumper terminals 1 and 6).
3. Connect the SIGNAL INPUT cable between point "A" and ground (figure 8).
4. Set the F.M. ATTENUATORS to MAX. and 10, F.M. SWEEP to 1, PHASING to 0, BLANKING to OFF, F.M. GENERATOR RANGE to B, and CENTER FREQUENCY dial pointer to 21.25 mc. (the intermediate frequency).
5. Set the oscilloscope controls to produce a convenient horizontal trace centered on the face of the cathode ray tube. Set the oscilloscope function control so the 60 cycle sine wave voltage, fed through the HORIZ. AMPL. cable, is the horizontal deflecting signal.
6. Advance the oscilloscope vertical gain until the pattern is one to two inches high. The pattern will be two S-shaped response curves. Adjust the PHASING control to bring the curves in phase as shown in figure 9.

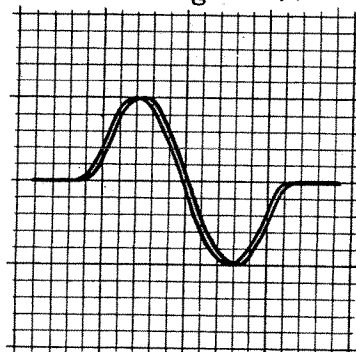

FIG. 9. DISCRIMINATOR RESPONSE - IN PHASE - BLANKING OFF

7. Adjust the F.M. SWEEP so the response curve covers most of the trace as shown in figure 9. Readjust the PHASING control if the traces separate. If the response

curve is not centered on the trace, reset the CENTER FREQUENCY pointer to center the pattern. Advance the BLANKING control to produce a pattern as shown in figure 10; this is a single curve with a base line through it.

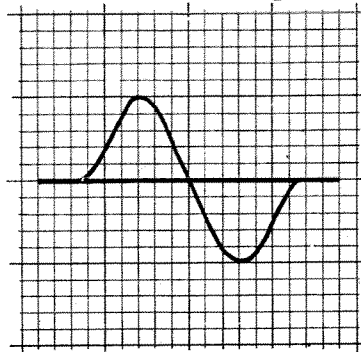

FIG. 10. DISCRIMINATOR RESPONSE — BLANKING ADJUSTED

8. Reduce the F.M. ATTENUATORS and advance the oscilloscope vertical gain for the lowest attenuator setting which gives a satisfactory pattern.

9. Set the SIGNAL switch to CAL., A.M. GENERATOR RANGE to B, SIGNAL ATTENUATORS low, and adjust the frequency to exactly 21.25 mc. (see CALIBRATION PROCEDURES on page 5).

10. Turn the SIGNAL SWITCH to MOD. R.F. A pattern similar to figure 11 will appear on the oscilloscope if the discriminator secondary is not aligned perfectly. Reduce the SIGNAL ATTENUATORS to as low a setting as possible with the 400 cycle pattern still showing.

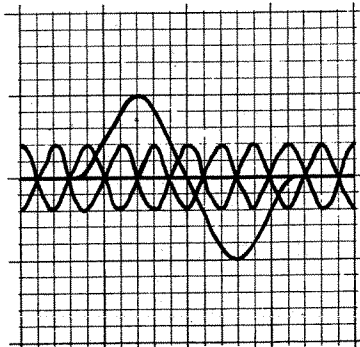

FIG. 11. DISCRIMINATOR RESPONSE — 400 CYCLE MODULATION

11. Adjust the discriminator secondary (L9 in figure 8) until the 400 cycle pattern disappears and then re-appears if the adjustment is continued in the same direction. Be sure to make this adjustment to the exact null point with the SIGNAL ATTENUATORS set low to avoid a broad response due to a high signal amplitude.

12. Adjust the discriminator primary (L8 in figure 8) until a maximum amplitude symmetrical pattern is achieved as shown in figure 7. Reduce the F.M. ATTENUATOR setting as the amplitude of the curve increases. Readjust the secondary if the 400 cycle modulation reappears.

13. Move the OUTPUT cable to the grid of the next preceding stage (point "D" in figure 8).

14. Move the SIGNAL INPUT connection to the grid of the limiter (point "C" in figure 8).

15. Turn the SIGNAL switch to UNMOD. R.F. and adjust the F.M. and SIGNAL ATTENUATORS to obtain an i-f response curve similar to figure 12. The curve may be distorted until the next adjustment has been made.

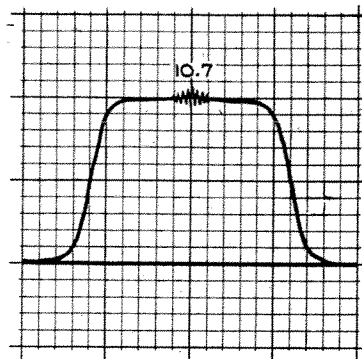

FIG. 12. SOUND I-F RESPONSE

16. Adjust L7 and L6 of figure 8 for a symmetrical response of maximum height similar to figure 12. The marker should appear at the center. Keep the F.M. ATTENUATORS set as low as possible to avoid overloading and keep the SIGNAL ATTENUATORS set low to avoid distortion of the response curve at the marker point.

17. Connect the OUTPUT cable to the grid of the next preceding stage (point "E" in figure 8). Adjust L5 and L4 for a symmetrical response curve of maximum height as in step 16 above.

The sound i-f adjustment is now complete. Adjustment of L2 and L3 was covered in video i-f alignment. However, if this were an f-m receiver instead of a television receiver, L2 and L3 would be adjusted to the intermediate frequency with the OUTPUT cable coupled to the converter grid. As the alignment proceeds from the discriminator back to the converter, the width of the response curve will decrease since the selectivity of the entire amplifier is greater than that of any one stage. If the response curve becomes too small, reduce the F.M. SWEEP. Any change in sweep width will require re-adjustment of the PHASING control. Adjust the PHASING control with BLANKING at OFF.

If it is desired to check the band pass of the i-f system, connect the OUTPUT cable to the grid of the converter tube and move the marker (with the A.M. Generator) from one side of the response curve to the other.

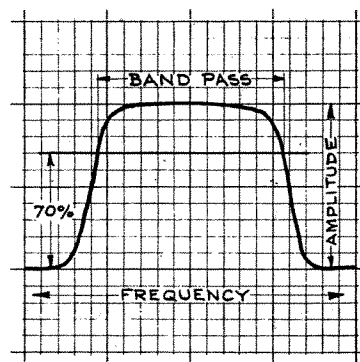

FIG. 13. I-F BAND PASS MEASUREMENT

The band pass of a resonant circuit is usually taken between the 70% response points. See figure 13. To check the band pass of the i-f system, set the A.M. Generator tuning knob to place the marker on the response curve at the 70% point on one side of the curve. Record the frequency indicated on the A. M. Generator dial. Then move the marker to the 70% response point on the other side of the curve. Record the frequency indicated on the A. M. Generator dial again. Then subtract the lower recorded frequency from the higher for the band of frequencies "passed".

TELEVISION TUNER ALIGNMENT

Many of the present day television sets use an r-f tuning unit produced by Standard Coil Products Co. This unit contains a 12-position rotary channel selector together with a stage of r-f amplification, an r-f oscillator, and an r-f mixer. The components are matched for the purpose of transferring the modulation on the tuned signal to an intermediate frequency. The various receiver manufacturers who use this tuner have used slightly different center intermediate frequencies, and some have used separate i-f strips for sound and video, while others have used intercarrier i-f amplification. The tuner can be adjusted to produce whatever output the manufacturer requires for his circuit, and manufacturer's literature will indicate the center frequency and the wave form required for servicing his equipment.

Admiral Corporation, for an example, uses the Standard Coil Products tuner diagrammed in figure 14a in their 21B1, 21C1, and 5D2 chassis. It is adjusted to tune, in the r-f amplifier, a double peaked curve with the center frequencies of the sound carrier and the video carrier at the peaks and not more than 30% reduction in response to frequencies within this 4.5 mc. range. Then the intermediate frequency output is balanced so that after it has passed through the i-f amplifiers, the center video carrier

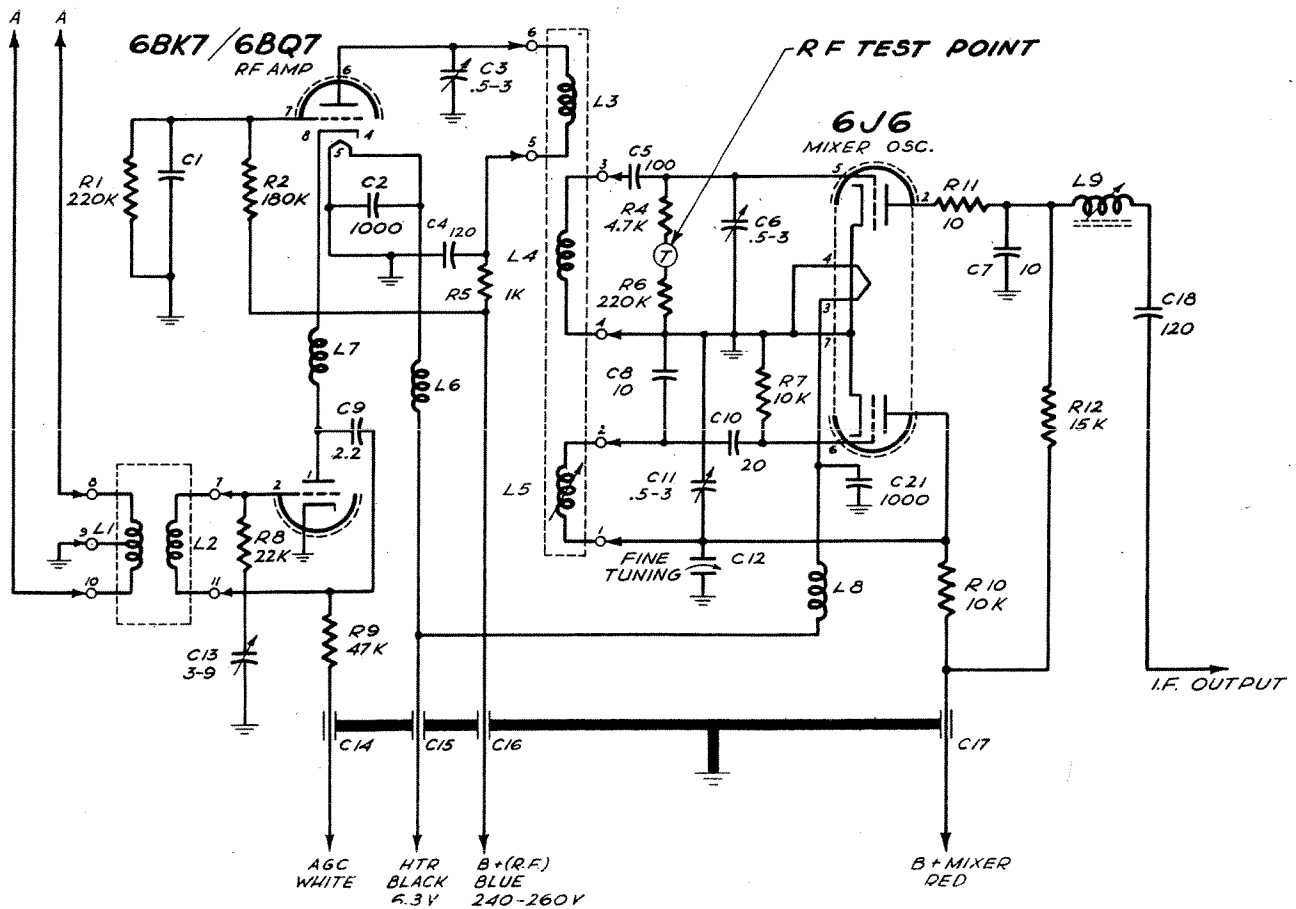

A. CIRCUIT FOR TV-114, 214, 293

FIG. 14, STANDARD C

is on one slope of the curve at a 50% response point, and the center sound carrier is on the other side of the curve at a 5% response point. The same pair of wave shapes need to be produced for each of the 12 channels. Each channel has a pair of tuned circuits with switch points which make all the necessary connections to tune both the received signal and the local oscillator for the frequencies necessary for the channel. The tuning problem consists of adjusting slugs for each of the 12 bands which insure that the maximum signal strength, with proper amplitude proportions for its component frequencies, will come out of the mixer.

In general, the manufacturer will specify an input across the antenna terminals at the center frequency of the channel, frequency modulated through a range of 10 megacycles or more, and marked at the video carrier frequency and the sound carrier frequency. Use the OUTPUT cable for this connection and set the termination box for the characteristic impedance of the antenna terminals (see table 2). Connect the SIGNAL INPUT cable at the r-f test point on top of the tuner chassis between the two tubes. The circuit position for this test point shows in figure 14A and B. Adjust the r-f stage tuning. Then move the SIGNAL INPUT cable to the next specified check point (probably in the i-f amplifier) and adjust the oscillator tuning for the specified response curve.

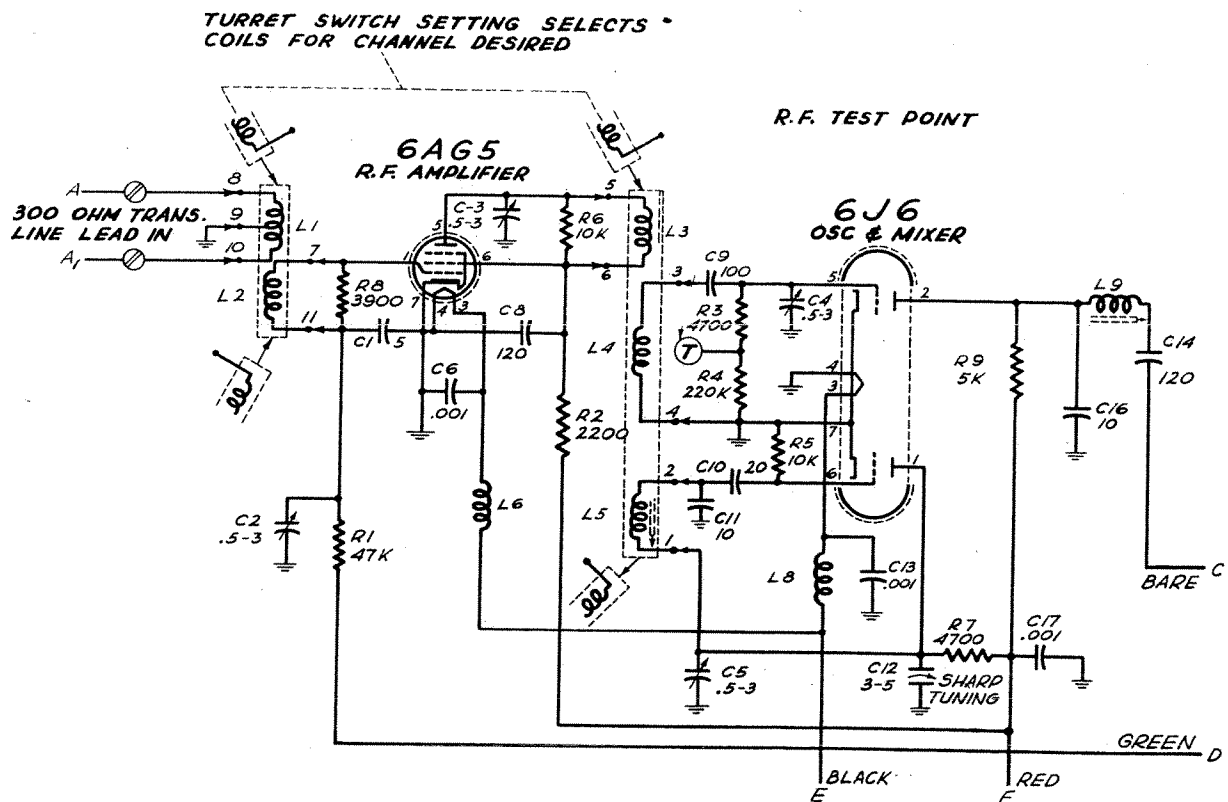

B. CIRCUIT FOR TV-2000 SERIES

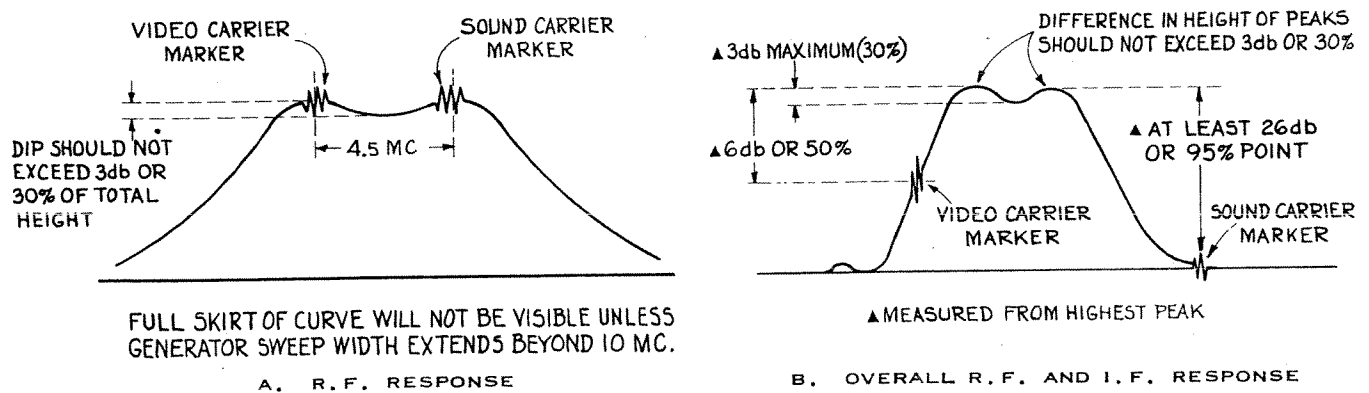

FIG. 15. TYPICAL TV TUNER RESPONSE

F. M. TUNER ALIGNMENT

Frequency modulation receivers have the following sections: r-f tuner, oscillator, mixer, i-f amplifier, limiter, discriminator, and a-f amplifier. The procedure for aligning the i-f amplifier, limiter, and discriminator is identical to the procedure for the sound section of a television receiver except that the intermediate frequency for f-m receivers is usually 10.7 mc. See page 17 for this data.

The general type of instructions for adjustment of the r-f tuner, oscillator, and mixer can be outlined, but the exact and complete procedure will vary from one manufacturer to another. Most receivers have provision for adjustment near the high end of the dial (108 mc.). Some have a low frequency adjustment in addition. It is advisable to consult manufacturer's literature to obtain the recommended frequency or frequencies.

1. Connect the VERT. AMPL. and HORIZ. AMPL. cables to the vertical and horizontal input terminals of the associated oscilloscope. Set the oscilloscope function control so the input at the horizontal input terminals is sent through the horizontal amplifier.

2. Connect the SIGNAL INPUT cable across the output of the demodulator stage (point "A" in figure 8).

3. Connect the OUTPUT cable through its matching network to the antenna terminals of the receiver. Connect the termination box according to the data in table 2 to provide the correct input for the receiver. Manufacturer's instructions should indicate whether this is 75 ohms or 300 ohms.

4. Set the A.M. Generator to the frequency recommended for alignment. Use the CALIBRATION PROCEDURE (page 5) to set this exactly. Set the receiver dial at the same frequency.

5. Rotate the SIGNAL ATTENUATORS, F.M. ATTENUATORS, and the oscilloscope vertical gain for a 400 cycle pattern with satisfactory height.

6. Adjust the oscillator, mixer, and r-f trimmers of the receiver to obtain a maximum amplitude pattern. Keep the SIGNAL and F.M. ATTENUATORS as low as possible, but keep a usable pattern on the cathode ray tube.

An alternate to the above method uses a frequency modulated signal input to the antenna, with a marker signal set at the desired frequency. Adjust the oscillator, mixer, and r-f trimmers of the receiver for a symmetrical response curve with a maximum amplitude, and with the marker centered on the curve.

Note that these instructions are very general. They are intended as a theoretical idea of alignment only. Always consult the receiver manufacturer's instructions for specific directions when aligning his sets and follow them. However, an oscilloscope can be used to advantage in addition to the vacuum tube voltmeter specified in many instructions. The oscilloscope will show the shape of the response wave form.

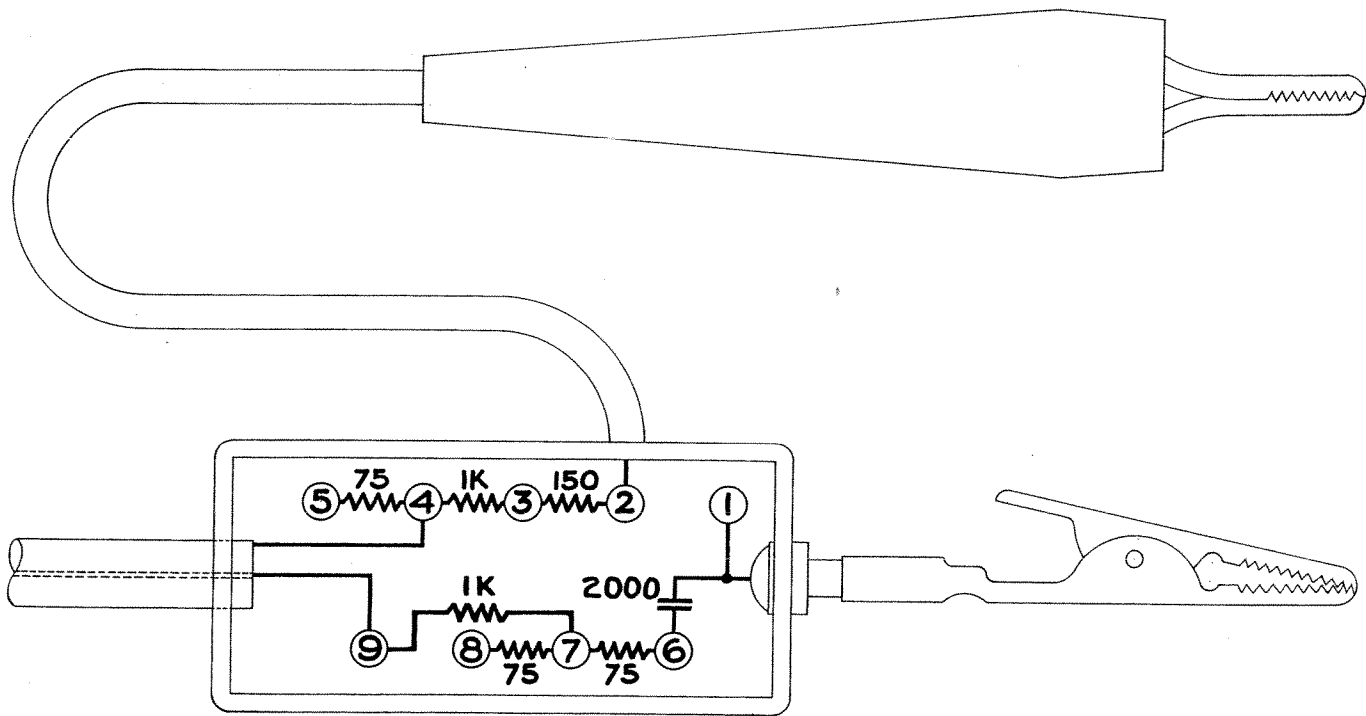

FIG. 16. IMPEDANCE MATCHING OUTPUT CABLE

TABLE 2. TERMINATION BOX CONNECTIONS

TERMINATION	CONNECTIONS	
300 OHMS	JUMPER 7-8-9-5	JUMPER 3-4
300 OHM WITH PAD *	JUMPER 3-8	JUMPER 5-9
75 OHMS	JUMPER 6-7-8-9-5	JUMPER 2-3-4
75 OHM WITH PAD *	JUMPER 6-7	JUMPER 2-3-8 JUMPER 5-9
OPEN TERMINATION	JUMPER 2-3-4	JUMPER 6-7-8-9
SERIES CAPACITOR	NO JUMPER 1-6	USE IN ADDITION TO TERMINATIONS INDICATED ABOVE.
RESISTANCE COUPLING, NO SERIES CAPACITOR	JUMPER 1-6	

*THE USE OF A PAD PROVIDES 1000 OHMS IN SERIES WITH EACH SIDE OF THE LINE

USING OUTPUT CABLE TERMINATION BOX

In order to simulate actual operating conditions, it is important that the receiver input impedance and the generator output impedance are matched. The OUTPUT cable for the Model 479 has a termination box built on the probe end to facilitate matching these impedances. See figure 16 and table 2 for an outline drawing of the probe and some of the possible connections. The two most commonly used impedances for receiver inputs are 75 ohms and 300 ohms. These are both available, with or without an isolating pad, by simply connecting bare wire jumpers as indicated in table 2. In each case, the connections are set to provide a 75 ohm termination for the Model 479 output because this value is proper for its output characteristics. Use of the pad provides isolation between the output of the Model 479 and the receiver points to which it is connected. If a series capacitor of 2000 uuf is desired in series with the receiver input for d-c blocking, do not jumper terminals 1 and 6, but if a straight resistance coupling is desired, jumper these terminals to short the capacitor which is built into the termination box. An open termination is provided for optional use: when using this connection, the Model 479 output is not impedance matched, but each side of the output is connected straight through (with the series capacitor if desired) to the two sides of the receiver input.

When operating in the new intermediate frequency range around 45 mc., the termination box may cause distortion of the response wave form. For best results, change the termination box connections as follows:

1. Pull the alligator clip off the post on the end of the termination box near screw terminal number 1.

2. Cut two pieces of solid bare jumper wire, #20 or 22, 1-3/4 inches long and one piece 1 inch long.

3. Loosen screws 2, 3, and 4, and place one 1-3/4" wire under them so that it is straight between the screws and then bends around screw number 2 with about 1/2 inch extending beyond the side of the termination box. Tighten the screws. This will be the ground lead.

4. Loosen screws 6, 7, 8, and 9. Place the other 1-3/4" wire under these screws. Keep the wire straight and tighten the screws.

5. Loosen screw number 1 and place one end of the 1" wire under it. With the wire extending off the side of the termination box, tighten the screw. This will be the "hot" lead.

6. Solder the "hot" lead to the connection point of the receiver and the ground lead to the chassis or receiver-ground.

This provides an open termination for the cable, with the 2000 uuf capacitor in series. It is important to keep the leads of the probe very short to obtain efficient operation.

An alternate method of handling this problem is to make up a special output cable to use for 45 mc. An Amphenol type 80M cable connector, about 3 feet of RG-59/U cable, and a 1000 uuf or 2000 uuf ceramic capacitor are all the required parts. Attach the connector on one end of the cable and solder one lead of the capacitor (clip the lead short) to the center conductor at the other end of the cable. Solder the other capacitor lead to the connection point in the receiver and the cable shield to the chassis or receiver ground.

A special OUTPUT cable assembly, Simpson part number 10-830046, for use at 45 mc., is now available as an accessory to owners of the Model 479.

Should other termination box connections than those listed in table 2 be desired, they may be obtained by using resistors between the terminals rather than using jumper wires. Suppose 150 ohms were desired. Connect a jumper across terminals 5 and 9 to provide the proper termination for the Model 479. Then connect a 75 ohm resistor from terminal 6 to terminal 7, a jumper from 7 to 8 to 9, a jumper from 3 to 4, and a 50 ohm resistor between terminals 2 and 3. If a pad is desired, leave the jumpers off of terminals 7-8-9 and terminals 3-4 and put in a jumper between terminals 3 and 8. Unlimited possibilities of terminations can be produced by this method of combining the resistances inside the termination box with external resistance.

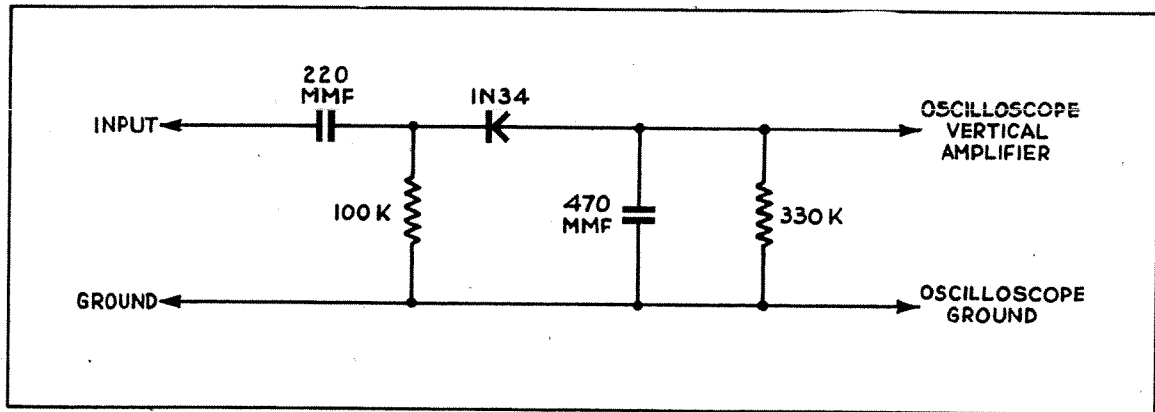

FIGURE 17. SCHEMATIC OF THE HIGH FREQUENCY PROBE

- SIGNAL TRACING

Figure 17 shows the arrangement of components in the Simpson High frequency Probe, No. 10-890025, which is available to owners of the Model 479 at a nominal cost. Connect this probe to the SIGNAL INPUT of the Model 479 to trace the signal through an f-m or television receiver. The probe is essentially a high frequency detector and it may be used to pick up the modulation on the signal from any part of the system where high frequencies exist.

To trace a signal through the sound channels of a television receiver or through an f-m receiver, connect the OUTPUT cable to the antenna terminals of the receiver and set the A.M. GENERATOR to the sound carrier frequency of the channel to which the receiver is tuned. Rotate the SIGNAL switch to MOD. R.F. Connect the high frequency probe cable to the SIGNAL INPUT jack and the ground lead to the receiver chassis. Starting at the grid of the converter, the signal may be picked up at each successive grid and plate through the i-f system. The 400 cycle modulation pattern should increase in amplitude as each successive stage is checked.

In a television receiver, the picture system may be traced in the same manner. Set the A.M. GENERATOR to the picture carrier frequency and the SIGNAL switch to MOD. R.F. for this test. Trace the signal from the grid of the converter tube through the video i-f amplifiers, noting the increase in amplitude of the 400 cycle modulation pattern as each successive stage is checked.

Any single stage may be checked by connecting the OUTPUT cable across the input of the stage with the A.M. GENERATOR set to the proper frequency for the stage. Contact the output of the stage with the high frequency probe.

TESTING THE AUDIO AMPLIFIER

The Model 479 contains a 400 cycle audio oscillator which can be used to test the audio amplifier section of a receiver. Set the SIGNAL switch at AUDIO. Use the OUTPUT cable and the SIGNAL ATTENUATORS. This feature is of special value when tests of the audio amplifier alone are desired.

To test the audio amplifier, connect the OUTPUT cable across the discriminator or detector output. Turn the volume control of the receiver to its full on position. With the SIGNAL switch in the AUDIO position and the SIGNAL ATTENUATORS and the oscilloscope vertical gain set for a satisfactory indication, connect the SIGNAL INPUT cable across the various points to be checked from the demodulator back to the speaker. Note the increase in signal strength as each successive stage is checked. Watch for distortion of the sine wave. Set the SIGNAL ATTENUATORS as low as possible to prevent overloading the vertical amplifiers of the oscilloscope since this would give a false indication of distortion in the receiver.

For the best indication of the 400 cycle sine wave, set the oscilloscope controls to produce a linear sweep which will show 3 or 4 complete sine waves. Internally synchronize the wave form to hold it steady on the oscilloscope.

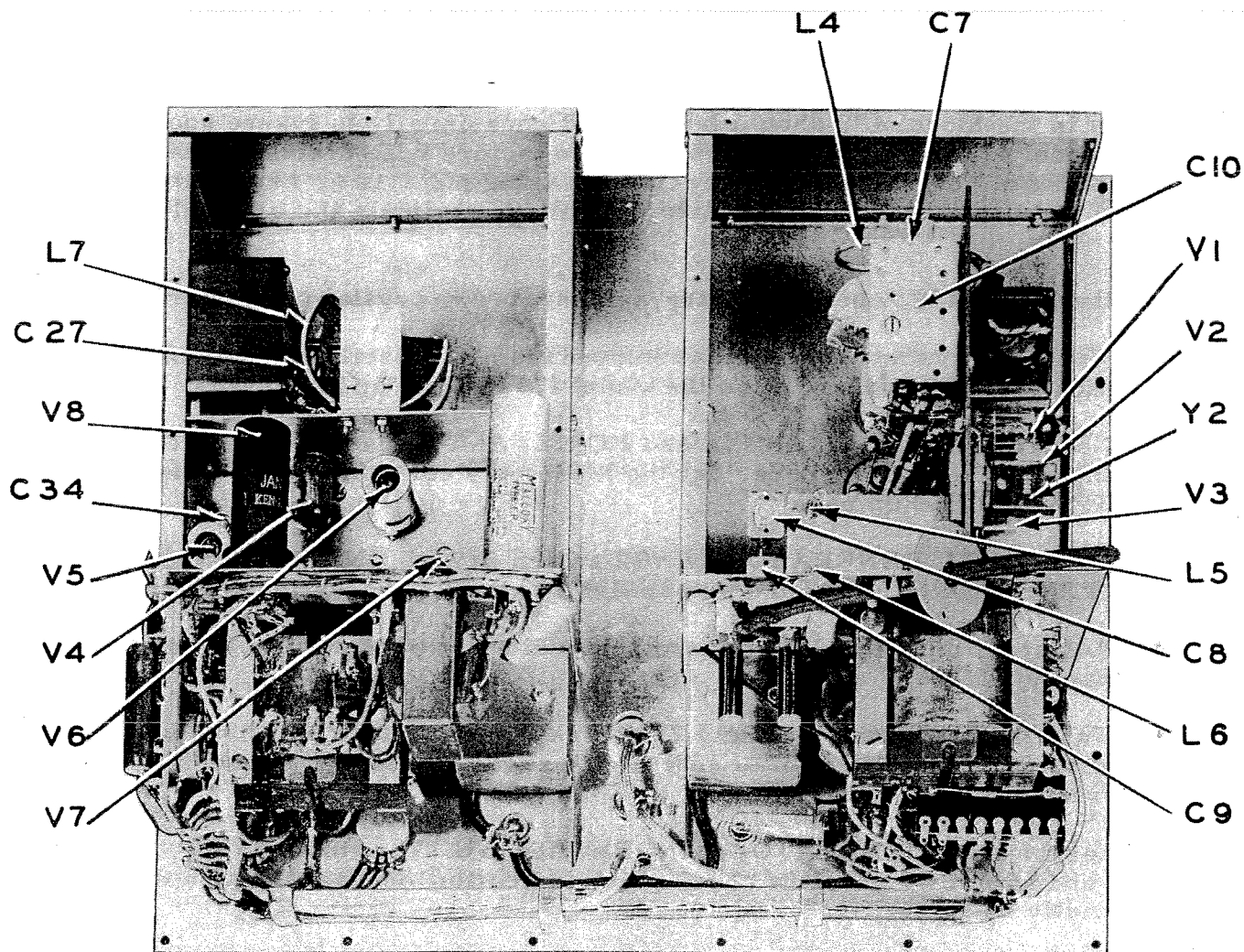

FIG. 18. REAR VIEW OF MODEL 479. CASE AND SHIELDING REMOVED

The chassis of the Model 479 is mounted into its case with 18 screws around the edge of the front panel. Removing these 18 screws and 2 on the back at the line cord hole cover will allow the assembly to be taken out of the case. Figure 18 is a rear view of the Model 479 with its case and some shielding removed.

When the chassis is removed from the case, the 5Z4 rectifier tube, power supply, and most front panel controls are available. Hole plugs over the internal adjustment points in the A.M. and F.M. Generators may be removed for aligning these sections while the shielding is in place.

If any components inside the generators need to be reached, remove the 18 screws holding the back shield in place (one screw is behind the 5Z4) and take off the panel. Five more screws hold the end of the A.M. Generator section in place; take it off and all components are exposed.

The F.M. Generator section contains four tubes. These are; V4, a 6AK5 f-m oscillator; V5, a 6C4 fixed oscillator (140 mc); V6, a 6AK5 mixer; and V7, a 6C4 used for f-m blanking.

The A.M. Generator section contains three tubes. These are: V1, a 6C4 variable r-f oscillator; V2, a 6J6 crystal oscillator and mixer; and V3, a 6J6 audio oscillator

and beat amplifier. The 5.0 mc. crystal also is in this section.

All tubes in the Model 479 should be checked occasionally to insure good performance. The Model 479 is adjusted carefully at the factory with precision standards, but due to the nature of very high frequency circuits aging of parts or replacement of tubes may require readjustment of the oscillator circuits to maintain the original accuracy.

Adjust the Model 479, when necessary, against its own crystal calibrator as follows:

1. With the back and top shields removed from both oscillator sections, turn the POWER switch to OPERATE and allow the Model 479 to warm up for at least 15 minutes.

2. Connect the VERT. AMPL. and HORIZ. AMPL. cables to the vertical and horizontal inputs of an oscilloscope. Set the Model 479 controls as specified for CALIBRATION PROCEDURE on page 5

3. Set the A.M. GENERATOR RANGE switch at A, SIGNAL switch to CAL., and SIGNAL ATTENUATORS low. Tune the oscillator to the 7.5 mc. calibration check point.

4. Adjust ^{C8}C9 until the 7.5 mc zero beat indication occurs when the dial pointer indicates exactly 7.5 mc.

5. Tune the oscillator for the 3.75 mc. calibration check point. Adjust ^{L5}L6 until the beat occurs when the dial pointer indicates exactly 3.75 mc. Recheck the 7.5 mc. setting and readjust ^{C8}C9 if necessary.

6. Set the A.M. GENERATOR RANGE switch to B. Tune to the 35 mc. calibrating check point and adjust ^{C8}C8 until the check point indication occurs when the dial pointer indicates exactly 35 mc. ^{C9}

7. Tune to the 15 mc. calibration check point and adjust ^{L6}L5 until the pointer is over the 15 mc. mark on the dial. Recheck the 35 mc. tuning point.

8. Set the A.M. GENERATOR RANGE switch to band C. Tune to the 120 mc. calibration check point and adjust C7 until the zero beat indication occurs when the dial pointer indicates exactly 120 mc.

9. Tune to the 75 mc. calibrating check point. This should fall exactly at the dial pointer position for 75 mc. unless L4 has been moved physically. If necessary, loosen the two set screws holding L4 in place and shift L4 in or out to obtain the beat pattern at the 75 mc. dial indication. Recheck the 120 mc. point. Replace the top shield of the A.M. Generator if it was removed for alignment to this step.

10. Connect a crystal diode (such as a 1N34) between the center contacts of the OUTPUT and SIGNAL INPUT jacks.

11. Set the SIGNAL switch at CAL. Tune the A.M. Generator to its 170 mc. calibrating check point. Turn the SIGNAL switch to UNMOD R.F. and advance the SIGNAL ATTENUATORS to 10 and MAX.

12. Set the F.M. GENERATOR RANGE switch at B, F.M. ATTENUATORS to MAX. and 10, F.M. SWEEP to 0, PHASING to 0, and BLANKING to OFF.

13. Tune the F.M. Generator around the 170 mc. dial mark for a zero beat indication between the two generators. See whether the dial pointer indicates 170 mc. on the CENTER FREQUENCY dial or if it is above or below the mark.

14. Set the A.M. GENERATOR RANGE to B, SIGNAL switch to CAL., and SIGNAL ATTENUATOR potentiometer to 6. Tune the A.M. Generator to its 70 mc. calibration check point. Turn the SIGNAL switch to UNMOD. R.F. and the SIGNAL ATTENUATOR potentiometer to 10.

15. Tune the F.M. Generator around the 140 mc. point on the dial for a zero beat between the two generators. See whether the dial pointer indicates 140 mc. on the CENTER FREQUENCY dial, or if it is above or below the mark. ↓ ↑

16. Adjust C27 for a compromise setting for the 170 mc. and 140 mc. frequency positions of the pointer.

17. Set the A.M. GENERATOR RANGE switch to C, SIGNAL switch to CAL., and SIGNAL ATTENUATOR potentiometer to 6. Tune the A.M. GENERATOR to the 240 mc. calibrating check point. Return the SIGNAL switch to UNMOD. R.F. and the SIGNAL ATTENUATOR potentiometer to 10.

18. Tune the F.M. Generator around the 240 mc. point on the dial for a zero beat between the two generators. Zero beat should occur at the 240 mc. mark on the dial unless the rotor for L7 has been moved on the tuning knob shaft. If it needs adjustment, tune to the zero beat point for 240 mc., loosen the allen head set screw on the shaft coupler, turn the tuning knob to place the pointer over the 240 mc. dial mark while holding L7 in position, and then tighten the allen head set screw. Recheck the 170 mc. and 140 mc. indications.

19. Set the SIGNAL switch at CAL. and the SIGNAL ATTENUATOR potentiometer at 6. Tune the A.M. Generator to the 165 mc. check point. Return the SIGNAL switch to UNMOD. R.F. and the SIGNAL ATTENUATOR potentiometer to 10.

20. Tune the F.M. Generator around the 165 mc. mark on the dial for a zero beat indication on the oscilloscope.

21. Remove the crystal diode from the OUTPUT and SIGNAL INPUT jacks. Attach the cables to these jacks.

22. Connect the OUTPUT cable to the input of an i-f strip tuned for a response pattern in the vicinity of 20 to 25 mc. Connect the SIGNAL INPUT cable to the grid or plate of the last i-f amplifier to obtain a wave form similar to figure 15B when the intermediate frequency is tuned with the F.M. Generator.

23. Set the A.M. GENERATOR RANGE switch to B, SIGNAL switch to CAL., and SIGNAL ATTENUATORS to 0 and X1. Tune the A.M. Generator to the 25 mc. calibrating check point. Set the SIGNAL switch at UNMOD. R.F.

24. Set the F.M. GENERATOR RANGE switch at A, F.M. ATTENUATORS at MAX. and 10, and F.M. SWEEP at 10. Tune C34 until the maximum i-f response is seen on the oscilloscope. Note that several response curves can be seen with very little rotation of C34. Tune to the largest response.

25. Advance the SIGNAL ATTENUATORS until a marker can be seen on the response pattern. Keep them set as low as possible with the marker just visible.

26. Reduce the F.M. SWEEP gradually toward zero. Adjust C34 to keep the marker on the trace as long as possible while reducing the sweep control. This is a rough adjustment of C34.

27. Remove the OUTPUT and SIGNAL INPUT cables and connect the IN34

between the center jack contacts. Turn the SIGNAL switch to CAL. and SIGNAL ATTENUATOR potentiometer to 6. Set the A.M. GENERATOR RANGE switch to C and tune the A.M. Generator to the 170 mc. check point. Turn the Signal switch to UNMOD. R.F. and the SIGNAL ATTENUATOR potentiometer to 10.

28. Set the F.M. GENERATOR RANGE switch to B and F.M. SWEEP at 0. Tune the F.M. Generator for a zero beat indication at 170 mc.

29. Set the SIGNAL ATTENUATOR potentiometer at 6, the SIGNAL switch at CAL., and the A.M. GENERATOR RANGE switch at B. Tune the A.M. Generator to the 30 mc. calibrating check point. Set the SIGNAL switch at UNMOD. R.F. and the SIGNAL ATTENUATOR potentiometer to 10.

30. Set the F.M. GENERATOR RANGE switch at A. Very carefully adjust C34 for a zero beat indication. This is a fine adjustment and should require only a slight touch-up adjustment on C34.

Caution: this fine setting should require no more than 30° of rotation of C34. If it appears to need more, go back to step 19 and repeat the steps more carefully.

31. Set the SIGNAL switch at CAL. and the SIGNAL ATTENUATOR potentiometer at 6. Tune the A.M. Generator to the 35 mc. calibrating check point. Turn the SIGNAL switch to UNMOD. R.F. and the SIGNAL ATTENUATORS to 10 and MAX.

32. Observe the oscilloscope while rotating the F.M. tuning knob. A constant zero beat should occur between the 35 mc. from the A.M. Generator and 140 mc. from the fixed oscillator regardless of the position of the pointer on the CENTER FREQUENCY dial. If this situation does not exist, the fixed oscillator is tuned to an incorrect frequency. Go back to step 19 and repeat the 140 mc. oscillator adjustment.

33. Remove the crystal diode and replace all shielding. The Model 479 oscillators are now aligned within the close tolerances to which they were adjusted when it was manufactured.

SWEEP ADJUSTMENT

The f-m sweep motor is factory adjusted to provide a sweep bandwidth of 15 mc. when operated on 110 volts, 60 cycles, and with the F.M. Generator tuned to 160 mc. and the F.M. SWEEP control at 10. Operation on other line voltages or at line frequencies other than 60 cycles will require re-setting of the sweep limiter adjustment, R55. Use the following procedure to adjust R55.

1. Turn the POWER switch of the Model 479 to OPERATE and allow 15 minutes for the unit to warm up. Connect the VERT. AMPL. and HORIZ. AMPL. cables to the vertical and horizontal inputs of an oscilloscope. Set the function switch of the oscilloscope to utilize the 60 cycle sine wave sweep for horizontal deflection. Connect a crystal diode (such as a 1N34) between the center contacts of the OUTPUT and SIGNAL INPUT jacks.

2. Set the A.M. GENERATOR RANGE switch to C, SIGNAL switch to CAL., and SIGNAL ATTENUATORS to 6 and MAX. Tune the AM Generator to the 160 mc. check point. Turn the SIGNAL switch to UNMOD. R.F. and the SIGNAL ATTENUATOR potentiometer to 10.

3. Set the F.M. GENERATOR RANGE switch to B, F.M. ATTENUATORS to MAX. and 10, and F.M. SWEEP to 0. Tune the F.M. Generator to zero beat at 160 mc.

4. Turn the F.M. SWEEP to 10 and the PHASING control to a position which produces an open oval or circle on the oscilloscope. Note the two markers on the pattern. Reduce the SIGNAL ATTENUATORS to as low a setting as will still keep the markers visible.

5. Rotate the A.M. Generator tuning knob and note that the two markers move around the trace until they join, produce a zero beat, and then disappear. Read the frequency on the A.M. Generator dial at the point where the markers zero beat.

6. Rotate the A.M. Generator tuning knob in the opposite direction until the markers move to the opposite side of the trace and join and zero beat again. Read the frequency on the A.M. Generator dial again at this zero beat point.

7. The frequencies in steps 5, and 6 identify the limit frequencies toward which the F.M. GENERATOR is being swept. These should have a difference of 15 mc. If they do not, adjust R55 to correct.

Caution: Do not adjust the sweep beyond the 15 mc. bandwidth point. The motor reaches the limit of its swing a little beyond this point and will be damaged if it is allowed to strike the stops for any considerable period of time.

Should your Model 479 fail to give satisfactory service due to reparable damage, it can be returned to the factory for repairs. Always accompany any equipment sent in for repair with a statement indicating where the trouble is; for example, "A.M. Generator dial binds" or "F.M. Generator intermittent after 2 hours of use", etc. This will facilitate repairs, keep your bill to a minimum, and insure that the fault will be corrected when you receive your Model 479 again.

WARRANTY

SIMPSON ELECTRIC COMPANY warrants each instrument and other articles of equipment manufactured by it to be free from defects in material and workmanship under normal use and service, its obligation under this warranty being limited to making good at its factory any instrument or other article of equipment which shall within 90 days after delivery of such instrument or other article of equipment to the original purchaser be returned intact to it, or to one of its authorized service stations, with transportation charges prepaid, and which its examination shall disclose to its satisfaction to have been thus defective; this warranty being expressly in lieu of all other warranties expressed or implied and of all other obligations or liabilities on its part and SIMPSON ELECTRIC COMPANY neither assumes nor authorizes any other persons to assume for it any other liability in connection with the sale of its products.

This warranty shall not apply to any instrument or other article of equipment which shall have been repaired or altered outside the SIMPSON ELECTRIC COMPANY factory or authorized service stations nor which has been subject to misuse, negligence or accident, incorrect wiring by others, or installation or use not in accord with instructions furnished by the manufacturer.

PARTS LIST - MODEL 479

CIRCUIT REFERENCE	DESCRIPTION	SIMPSON PART NUMBER
C1	Capacitor 8200uuf mica	1-113911
C2	Capacitor .05uf 400 V. paper	1-113899
C3	Capacitor 8200uuf mica	1-113911
C4	Capacitor .05uf 400 V. paper	1-113899
C5	Capacitor 5000uuf ceramic	1-113913
C6	Capacitor .02uf 400 V paper	1-113898
C7	Capacitor 4.5-25uuf trimmer	1-114659
C8	Capacitor 2.2-20uuf trimmer	1-113891
C9	Capacitor 2.2-20uuf trimmer	1-113891
C10	Capacitor, 2 gang tuning	1-113916
C11	Capacitor, 2000uuf ceramic	1-113855
C12	Capacitor, 2000uuf ceramic	1-113855
C13	Capacitor, 10uuf ceramic	1-113895
C14	Capacitor, 470uuf ceramic	1-113978
C15	Capacitor, 2000uuf ceramic	1-113855
C16	Capacitor, 0.1uf 400 V. paper	1-113902
C17	Capacitor, 2000uuf ceramic	1-113855
C18	Capacitor, 2000uuf ceramic	1-113855
C19-26	Capacitors, 1000uuf feedthrough	1-114643
C19-26	Assembled on one plate	10-890126
C27	Capacitor, 2-6uuf trimmer	1-113915
C28	Capacitor, 100uuf ceramic	1-113912
C29	Capacitor, 220uuf ceramic	1-113854
C30	Capacitor, 220uuf ceramic	1-113854
C31	Capacitor, 220uuf ceramic	1-113854
C32	Capacitor, 3.3 uuf ceramic	1-113893
C33	Capacitor, 3.3 uuf ceramic	1-113893
C34	Capacitor, 3.5-15uuf trimmer	1-113920
C35	Capacitor, 100uuf ceramic	1-113912
C36	Capacitor, 220uuf ceramic	1-113854
C37	Capacitor, 220uuf ceramic	1-113854
C38	Capacitor, 2000uuf ceramic	1-113855
C39	Capacitor, 5000uuf ceramic	1-113913
C40	Capacitor, 5000uuf ceramic	1-113913
C41	Capacitor, 220uuf ceramic	1-113854
C42-50	Capacitors, 1000uuf feedthrough	1-114643
C42-50	Assembled on one plate	10-890127
C51	Capacitor, 100uuf ceramic	1-113912
C52	Capacitor, 100uuf ceramic	1-113912
C53	Capacitor, 0.25uf 400 V. paper	1-113903
C54	Capacitor, 40-10uf 350V.D.C. electrolytic	1-113963
C56	Capacitor, 5000uuf ceramic	1-113913
C57	Capacitor, 5000uuf ceramic	1-113913
C58	Capacitor, .02uf 400 V. paper	1-113898
C59	Capacitor, .02uf 400 V. paper	1-113898
C60	Capacitor, 2000uuf ceramic	1-113855
F1	Fuse, 2 amp 3AG	1-112911
J1	Jack, OUTPUT	1-113982
J2	Jack, SIGNAL INPUT	1-113983
J3	Jack, VERT. AMPL.	1-113983
J4	Jack, HORIZ. AMPL.	1-113983
L1	Line Filter	10-890040
L2	Line filter	10-890040

PARTS LIST — MODEL 479

CIRCUIT REFERENCE	DESCRIPTION	SIMPSON PART NUMBER
L3	85uh choke coil	10-890034
L4	Oscillator coil, A.M. Band "C"	10-890033
L5	Oscillator coil, A.M. Band "A"	10-890031
L6	Oscillator coil, A.M. Band "B"	10-890032
L7	Coil assembly, F.M. tuner	10-890028
L8	Oscillator coil, 140mc.	10-890030
L9	Filter choke, Power supply	10-890039
M1	Sweep motor assembly	22-302118
R1	Resistor, 56K 1/2 W. 10%	1-113947
R2	Resistor, 33K 1/2 W. 10%	1-113933
R3	Resistor, 22K 2W. 10%	1-113959
R4	Resistor, 100K 1/2 W. 10%	1-113949
R5	Resistor, 100K 1/2 W. 10%	1-113949
R6	Resistor, 1K 1/2 W. 10%	1-111689
R7	Resistor, 47 ohms 1/2 W. 10%	1-113921
R8	Resistor, 100K 1/2 W. 10%	1-113949
R9	Resistor, 6.8K 1/2 W. 10%	1-113048
R10	Resistor, 22K 2W. 10%	1-113959
R11	Resistor, 22K 2W. 10%	1-113959
R12	Resistor, 18K 1/2 W. 10%	1-113943
R13	Resistor, 33K 2W. 5%	1-113960
R14	Resistor, 33K 2W. 5%	1-113960
R15	Resistor, 33K 1/2 W. 10%	1-113945
R16	Resistor, 10K 1/2 W. 10%	1-111671
R17	Resistor, 8200 2W. 10%	1-113956
R18	Resistor, 1K 1/2 W. 10%	1-111689
R19	Resistor, 7.5K 5W. 10%	1-113979
R20	Resistor, 6.8K 1/2 W. 10%	1-113048
R21	Resistor, 10K 1/2 W. 10%	1-111671
R22	Resistor, 1K 1/2 W. 10%	1-111689
R23	Resistor, 100 ohm 1/2 W. 10%	1-111940
R24	Resistor, 18K 1/2 W. 10%	1-113943
R25	Resistor, 33K 2W. 10%	1-113961
R26	Resistor, 100K 1/2 W. 10%	1-113949
R27	Resistor, 10Meg 1/2 W. 10%	1-111693
R28	Resistor, 2200 ohm 1/2 W. 10%	1-113941
R29	Resistor, 2200 ohm 1/2 W. 10%	1-113941
R30	Resistor, 12K 2W. 10%	1-113958
R31	Resistor, 100K 1/2 W. 10%	1-113949
R32	Resistor, 150 ohm 1/2 W. 5%	1-113927
R33	Potentiometer, 50K	1-113877
R34	Resistor, 91 ohm 1/2 W. 10%	1-113923
R35	Resistor, 750 ohm 1/2 W. 10%	1-111684
R36	Resistor, 91 ohm 1/2 W. 10%	1-113923
R37	Resistor, 750 ohm 1/2 W. 10%	1-111684
R38	Resistor, 91 ohm 1/2 W. 10%	1-113923
R39	Resistor, 750 ohm 1/2 W. 10%	1-111684
R40	Resistor, 91 ohm 1/2 W. 10%	1-113923
R41	Resistor, 750 ohm 1/2 W. 10%	1-111684
R42	Resistor, 82 ohm 1/2 W. 10%	1-113922
R43	Resistor, 56K 1/2 W. 10%	1-113947
R44,45	Dual Potentiometer, 2K each section	1-113880

PARTS LIST - MODEL 479

CIRCUIT REFERENCE	DESCRIPTION	SIMPSON PART NUMBER
R46	Resistor, 75 ohm 1/2W. 5%	1-114113
R47	Resistor, 750 ohm 1/2W. 10%	1-111684
R48	Resistor, 91 ohm 1/2W. 10%	1-113923
R49	Resistor, 750 ohm 1/2W. 10%	1-111684
R50	Resistor, 91 ohm 1/2W. 10%	1-113923
R51	Resistor, 750 ohm 1/2W. 10%	1-111684
R52	Resistor, 91 ohm 1/2W. 10%	1-113923
R53	Resistor, 750ohm 1/2W. 10%	1-111684
R54	Resistor, 82 ohm 1/2W. 10%	1-113922
R55	Potentiometer, 10ohm	1-113881
R56	Resistor, 6.8 ohm 2W. 10%	1-113955
R57	Potentiometer, 50 ohm	1-113882
R58	Resistor, 7K 20W.	1-113919
R59	Potentiometer, 1 Meg with switch	1-113870
R60	Potentiometer, 500K	1-114153
R61	Resistor, 10K 1/2W. 10%	1-111671
R62	Resistor, 330K 1/2W. 10%	1-113950
R63	Resistor, 150 ohm 1/2W. 10%	1-113926
R117	Resistor, 680 ohm 1W. 10%	1-113929
S1	Switch, A.M. GENERATOR RANGE	1-113889
S2	Switch, POWER	1-113883
S3	Switch, SIGNAL	1-113884
S4	Switch, F.M. GENERATOR RANGE	1-113885
S5	Switch, F.M. ATTENUATOR	1-113886
S6	Switch, SIGNAL ATTENUATOR	1-113886
T1	Transformer, Plate	10-890038
T2	Transformer, Modulation	10-890037
T3	Transformer, Filament	10-890044
V1	Tube, 6C4, A.M. Oscillator	1-113975
V2	Tube, 6J6. Crystal Oscillator & Mixer	1-113639
V3	Tube, 6J6 , Audio Oscillator & Beat Amplifier	1-113639
V4	Tube, 6AK5, F.M. Oscillator	1-113611
V5	Tube, 6C4, 140 mc. Oscillator	1-113975
V6	Tube, 6AK5, F.M. Mixer	1-113611
V7	Tube, 6C4, Blanking	1-113975
V8	Tube, 5Y3GT, Rectifier (or 5Z4)	1-114671 1-113976
Y1	Crystal Diode, 1N34	1-113852
Y2	Crystal 5.0 mc. .05%	1-113965
	Output cable with termination box	0-008370
	Oscilloscope and signal input cables.	0-008371
	Dial Assembly, A.M.	10-890027
	Dial Assembly, F.M.	10-890026
	Knob, pointer type	3-260180
	Knob, tuning type	1-114050

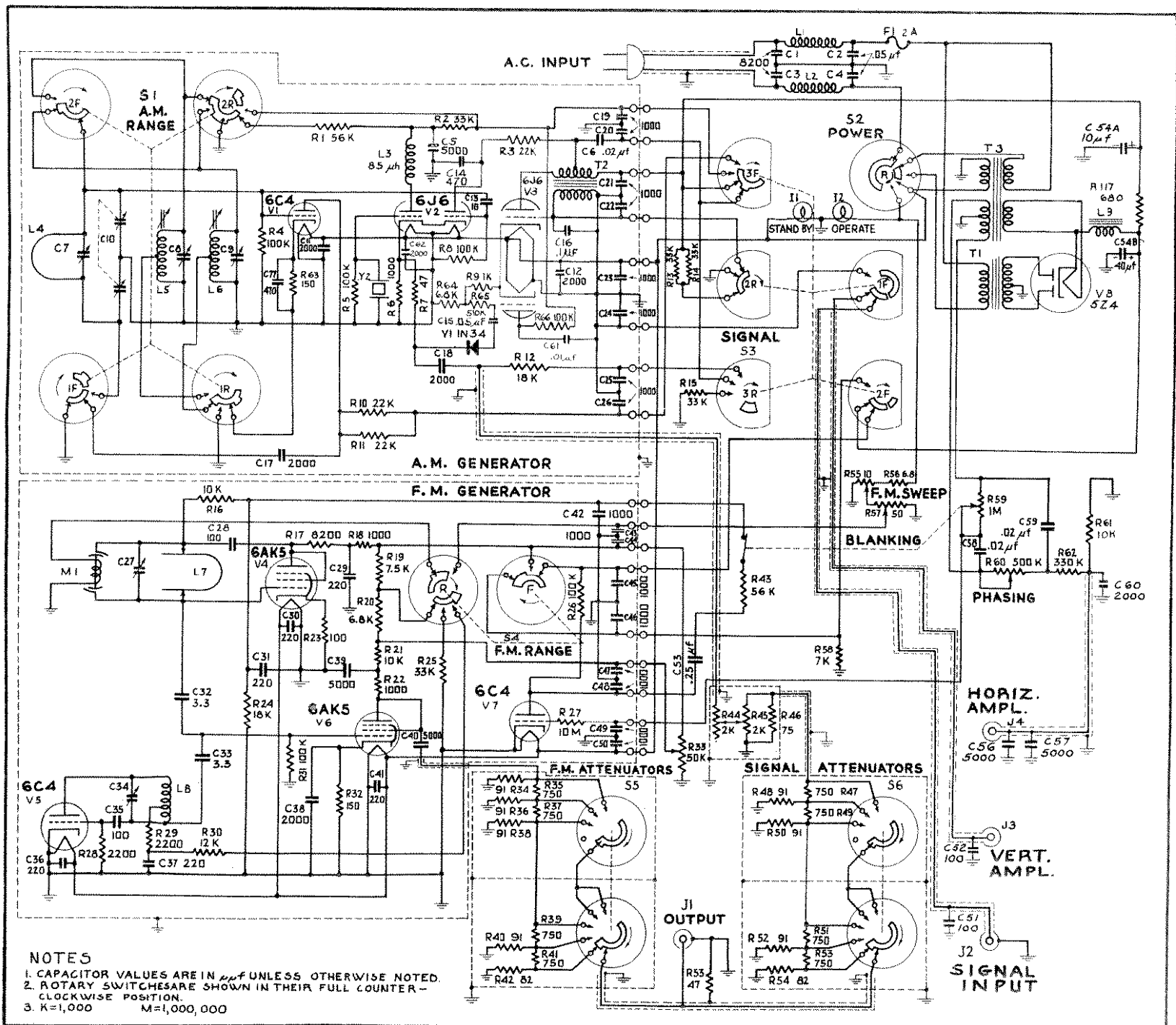

NOTES
1. CAPACITOR VALUES ARE IN µF UNLESS OTHERWISE NOTED.
2. ROTARY SWITCHES ARE SHOWN IN THEIR FULL COUNTER-CLOCKWISE POSITION.
3. K=1,000 M=1,000,000

FIG. 19. MODEL 479 SCHEMATIC DIAGRAM