

Simpson

INSTRUMENTS THAT STAY ACCURATE

OPERATOR'S MANUAL

SIMPSON 710
FREQUENCY COUNTER

WARNING

For safe usage, it is essential that the operator read this manual carefully before using the instrument for any measurements.

SIMPSON ELECTRIC COMPANY

853 Dundee Ave., Elgin, Illinois 60120

Area Code 312, Telephone 697-2260

In Canada, Bach-Simpson, Ltd., London, Ontario

DIGITAL INSTRUMENT Warranty

SIMPSON ELECTRIC COMPANY warrants each digital instrument manufactured by it to be free from defects in material and workmanship under normal use and service, its obligation under this warranty being limited to making good at its factory any digital instrument which shall within one (1) year after delivery of such instrument or other article of equipment to the original purchaser be returned intact to it, or to one of its authorized service stations, with transportation charges prepaid, and which its examination shall disclose to its satisfaction to have been thus defective; this warranty being expressly in lieu of all other warranties expressed or implied and of all other obligations or liabilities on its part, and SIMPSON ELECTRIC COMPANY neither assumes nor authorizes any other persons to assume for it any other liability in connection with the sale of its products.

This warranty shall not apply to any digital instrument which shall have been repaired or altered outside the SIMPSON ELECTRIC COMPANY factory or authorized service stations, nor which has been subject to misuse, negligence or accident, incorrect wiring by others, or installation or use not in accord with instructions furnished by the manufacturer.



ELECTRIC COMPANY

853 Dundee Ave., Elgin, Illinois 60120

Phone: (312) 697-2260

IN CANADA: Bach-Simpson, Ltd., London, Ontario

IN ENGLAND: Bach-Simpson (U.K.) Limited, Wadebridge, Cornwall

IN INDIA: Ruttonsha-Simpson Private, Ltd., International House,
Bombay-Agra Road, Vikhroli, Bombay



OPERATOR'S MANUAL

SIMPSON 710 FREQUENCY COUNTER

SIMPSON ELECTRIC COMPANY

853 Dundee Ave., Elgin, Illinois 60120

Area Code 312, Telephone 697-2260

In Canada, Bach-Simpson, Ltd., London, Ontario

1M379 (123.01)

Effective Date: Immediately

EDITION: 5th

Part No. 6-110378

TABLE OF CONTENTS

SECTION I

Introduction	1-1
1.1 General	1-1
1.2 Description	1-1
1.3 Safety Considerations	1-2
1.4 Supplies and Accessories	1-2
1.5 Technical Data	1-2

SECTION II

Installation	2-1
2.1 General	2-1
2.2 Unpacking and Inspection	2-1
2.3 Warranty	2-1
2.4 Shipping	2-2
2.5 Power Source Requirements	2-2
2.6 Installation	2-2

SECTION III

Controls, Connectors, and Indicators	3-1
3.1 General	3-1
3.2 Front and Side Panel Description	3-1

SECTION IV

Operation	4-1
4.1 General	4-1
4.2 Safety Precautions	4-1
4.3 Frequency Measurement Procedure	4-3
4.4 Applications	4-3

SECTION V

Theory of Operation	5-1
5.1 General	5-1
5.2 Frequency Measurement	5-1



Figure 1-1. Model 710 Frequency Counter

5.3	Amplifier	5-1
5.4	Time Base Generator	5-1
5.5	Gate and Gate Control Circuits	5-3

SECTION VI

Servicing Instructions		6-1
6.1	General	6-1
6.2	Line Voltage	6-1
6.3	Instrument Cover Removal	6-1
6.4	Calibration	6-2
6.5	Replacement Parts and Schematic Diagram	6-4

LIST OF TABLES

1-1	Technical Data	1-3
1-2	Items and Accessories Furnished With This Instrument	1-4
3-1	Front and Side Panel Description	3-1
6-1	Typical Power Supply Voltage	6-2
6-2	Replacement Parts	6-4

LIST OF ILLUSTRATIONS

1-1	Simpson 710 Frequency Counter	ii
3-1	Front and Side Panel, Controls, Connectors, and Indicators	3-2
5-1	Block Diagram	5-2
6-1	Timing Diagram (Frequency Measurement shown in Hz Position)	6-3

SAFETY SYMBOLS



This marking adjacent to another marking or a terminal or Operating device indicates that the Operator must refer to an explanation in the Operating Instructions to avoid damage to the equipment and/or to avoid personal injury.

WARNING

The WARNING sign denotes a hazard. It calls attention to a procedure, practice or the like, which if not correctly performed or adhered to, could result in personal injury.

CAUTION

The CAUTION sign denotes a hazard. It calls attention to a procedure, practice or the like, which if not correctly adhered to could result in damage to or destruction of part or all of the Instrument.



HIGH VOLTAGE WARNING: An output terminal at which a voltage, with respect to another terminal or to earth ground, exists or may be adjusted to exceed 1000 volts AC or DC if a current exceeding 0.5 milliamperes can be delivered into a 1500 ohm resistive load connected between the same points. The symbol is an additional warning that a very dangerous voltage may exist at the terminal, and the terminal and its connecting leads must not be handled while energized.



GROUNDING TERMINAL (PROTECTIVE): A terminal which must be connected to earth ground by the Operator or Installer prior to making any other connections to the equipment for personal protection from electrical shock.



GROUNDING TERMINAL: A terminal which is connected to earth ground by means of an earth grounding system and which is intended to be connected to other circuits or equipment by the Operator or Installer for purposes other than protection from electrical shock.

WARNING

This Instrument is designed to prevent accidental shock to the operator when properly used. However, no engineering design can render safe an instrument which is used carelessly. Therefore, this manual must be read carefully and completely before making any measurements. Failure to follow directions can result in a serious or fatal accident.

SHOCK HAZARD: As defined in American National Standard, C39.5, Safety Requirements for Electrical & Electronic Measuring & Controlling Instrumentation, a shock hazard shall be considered to exist at any part involving a potential in excess of 30 volts rms (sine wave) or 42.4 volts DC or peak and where a leakage current from that part to ground exceeds 0.5 milliampere, when measured with an appropriate measuring instrument defined in Section 11.6.1 of ANSI C39.5.

NOTE: The proper measuring instrument for the measurement of leakage current consists essentially of a network of a 1500 ohm non-inductive resistor shunted by a 0.15 microfarad capacitor connected between the terminals of the measuring instrument. The leakage current is that portion of the current that flows through the resistor. The Simpson Model 229-Series 2 AC Leakage Current Tester meets the ANSI C39.5 requirements for the measurement of AC leakage current and can be used for this purpose. To measure DC Leakage current, connect a 1500 ohm non-inductive resistor in series with a Simpson 0-500 DC microammeter and use this as the measuring instrument.

INTRODUCTION

1.1 GENERAL

1.1.1 The Simpson 710 Frequency Counter (hereafter referred to as the 710, or the Instrument) is a highly accurate, versatile frequency counter suitable for use in C.B. communications, servicing, production line testing, laboratory, and in digital systems for industrial controls. Specifically, the 710 (Figure 1-1), is intended for any use where frequencies are to be measured. The Instrument provides direct counting capability from 10 Hz to frequencies in excess of 60 MHz. When interfaced with a high frequency prescaler such as the Simpson 7020, the 710 counting capability is extended to high frequency signals in excess of 500 MHz. For other applications, refer to paragraph 4.4 of this manual.

1.2 DESCRIPTION

1.2.1 This highly accurate Instrument features an overrange capability which provides up to nine-digit resolution in frequency measurements. Maximum reliability, with a minimum number of components, is achieved by using monolithic integrated circuits. The Instrument maintains its rated accuracy over a wide temperature range and line voltage variations. Standard features include: 0.35 inch high LED display, display storage, automatic decimal point location, ± 10 PPM time base accuracy, overrange indication, high input impedance, and input over-load protection. This Instrument can operate with 120V AC 50-400 Hz adapter (catalog number 00751); 230V AC 50-400 Hz adapter (catalog number 00752) or 12V DC auto cigarette lighter adapter (catalog number 00756).

1.2.2 The 710 provides numerical display of average frequencies from 10 Hz to 60 MHz in two ranges.

1.2.3 Components in the frequency counter have been placed for ease of maintenance and increased instrument durability. All circuit components are mounted on only two printed circuit boards for both instrument reliability and access to test points. Ambient lighting effects are minimized by a filter which reduces reflections and background illuminations. With simplified switch and control nomenclatures, operator errors are reduced to a minimum. Personnel with no experience with an instrument of this type can obtain quick and accurate measurements with minimum training.

1.3 SAFETY CONSIDERATIONS

1.3.1 This Operator's Manual contains cautions and warnings alerting the user to hazardous operating and service conditions. This information is flagged by CAUTION or WARNING headings throughout this publication, where applicable, and are defined at the front of this manual under SAFETY SYMBOLS. To ensure the safety of operating and servicing personnel and to retain the operating conditions of the Instrument these instructions must be adhered to.

1.4 SUPPLIES AND ACCESSORIES

1.4.1 All supplies and accessories required for the operation of the Frequency Counter are furnished with each Instrument and listed in the accompanying Table 1-2. Available replacement parts are listed in Table 6-2.

Introduction

1.5 TECHNICAL DATA

1.5.1 Table 1-1 lists the technical data for the Simpson 710.

Table 1-1. Technical Data

1. FREQUENCY

Frequency Range: 10 Hz to 60 MHz
Gate Time: 10 msec (0.1 kHz resolution), 1 sec. (1 Hz resolution)
Accuracy: ± 1 count \pm time base accuracy

2. INPUT CHARACTERISTICS

INPUT (AC coupled)

Impedance: 1 M Ω shunted by 30 pF
Frequency Range: 10 Hz to 60 MHz
Sinewave
Sensitivity: 50 mV RMS, from 10 Hz to 50 MHz;
100 mV RMS 50 MHz to 60 MHz
Maximum Input Voltage: 240 V peak, from 10 Hz to 100kHz derated to 100V peak at 1 MHz and 25 V peak to 60 MHz.

3. INTERNAL TIME BASE

Frequency: 6.5536 MHz
Temperature Stability: ± 10 ppm maximum, 0°C to +45°C
Aging Rate: ± 5 ppm maximum per year
Stability with Line Voltage Variations: ± 1 ppm for $\pm 10\%$ line voltage variation

Introduction

4. INPUT FILTER: 3 dB at 1 MHz

5. GENERAL

Display: 0.35 inch character height, 7-segment LED type 6 digits
Sample Rate: 5 sample/sec at MHz position
0.5 sample/sec at Hz position

6. TEMPERATURE RANGE

Operating: 0°C to +45°C
Storage: -40°C to +70°C

7. POWER

REQUIREMENT: 120 VAC $\pm 10\%$, (standard) or 230 VAC $\pm 15\%$ (optional) 50, 60, 400 Hz; approximately 5 VA

8. DIMENSIONS

Height: 2 in. (50.8mm)
Width: 5.6 in. (142.2mm)
Depth: 4.6 in. (116.8mm)

Table 1-2.
Accessories and Items Furnished with Instrument

DESCRIPTION	NUMBER
710 Frequency Counter	10-863799
AC Adapter 120VAC (Standard)	00751
AC Adapter 230VAC (Optional)	00752
Operator's Manual	6-110378

SECTION II

INSTALLATION

2.1 GENERAL

2.1.2 This section contains information and instructions for the installation and shipping of the 710. Included are unpacking and inspection procedures, warranty, shipping, power source requirements and installation.

2.2 UNPACKING AND INSPECTION

2.2.1 Unpack and inspect the Instrument for possible damage in shipment. Check the electrical performance as soon as possible. If damage is noted, notify the carrier and supplier before using the Instrument. Also, check that all items are included (Table 1-2).

2.2.2 Save the shipping carton and packing materials for future storing or shipping of the Instrument.

2.3 WARRANTY

2.3.1 The Simpson Electric Company warranty policy is printed on the inside front cover of this manual. Read it carefully prior to requesting a warranty repair.

NOTE: For assistance of any kind, including help with the Instrument under warranty, contact the nearest Authorized Service Center for instructions (listed on the last pages of this manual). If it's necessary to contact the factory directly, give full details of the difficulty and include the Instrument model number, serial number (at the back of the Instrument) and date of purchase. Service data or shipping instructions will be sent to you promptly. If an estimate of charges for non-warranty or other

Installation

service work is required, a maximum charge estimate will be quoted. This charge will not be exceeded without prior approval.

2.4 SHIPPING

2.4.1 Pack the Instrument carefully and ship it prepaid to the proper destination. Insure the shipment.

2.5 POWER SOURCE REQUIREMENTS

WARNING

The 710 is designed specifically to be used with the Simpson 120 VAC adapter (Cat No. 00751) or the 230 VAC adapter (Cat. No. 00752). If a substitute adapter is used, make certain it is insulated for at least 250 VAC between the primary and secondary circuits in accordance with applicable safety standards.

2.5.1 Connect the adapter supplied to the appropriate external power source. (Refer to the markings on the adapter for power source requirements.)

WARNING

Before proceeding with the operation of the 710, review the SHOCK HAZARD at the front of this manual.

2.6 INSTALLATION

2.6.1 The Instrument may be set horizontally on its rubber feet or vertically on its back and operated in either position. The Instrument can also be set at an inclined angle by positioning the stand under the unit.

SECTION III

CONTROLS, CONNECTORS, AND INDICATORS





3.1 GENERAL

3.1.1. All operating and adjustment controls, connectors, and indicators are described in this section along with a list (Table 3-1) describing their function. Become familiar with each item prior to operating the instrument.

3.2 FRONT AND SIDE PANEL DESCRIPTION

3.2.1 Table 3-1 lists all front, rear panel controls, connectors, and indicators. Figure 3-1 shows the locations.

Table 3.1. Front and Side Panel Description

- | | |
|---|--|
| 1. POWER Switch: | Pushbutton switches used to apply or turn off input power to the Instrument. |
| ON  | |
| OFF  | |
| 2. MHz Switch: | Selects 10 mSec gate time for frequency measurements. Automatically locates decimal point for MHz reading. |
| 3. Hz Switch: | Selects 1 sec gate time for frequency measurements. Readings are in Hz. |
| 4. Filter: | Selects low-pass filter to eliminate high frequency noise on low frequency signals. |
| IN  | |
| OUT  | |
| 5. INPUT Connector: | Provides AC coupling to the amplifier. |

Controls, Connectors and Indicators

- 6. Overrange Indicator:** Illuminates when the measured signal value exceeds the full scale range (999999 counts).
- 7. Numeric Display Indicator:** 7 Segment LED display to indicate magnitude of the signal being measured.
- 8. INPUT POWER:** This receptacle accepts the DC power from AC adapter or 12 V DC Auto Cigarette lighter adapter.

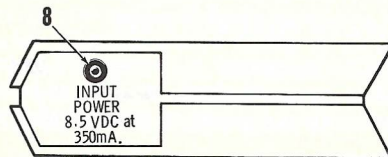
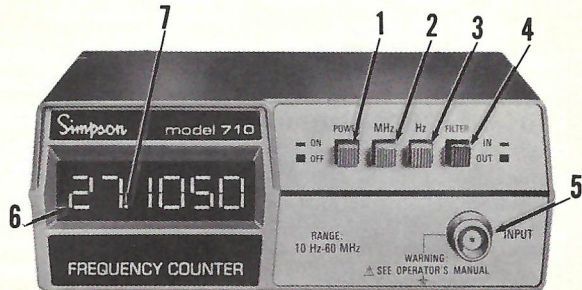

Figure 3-1. Front and Side Panel Controls, Connectors, and Indicators

SECTION IV

OPERATION

4.1 GENERAL

WARNING

Before proceeding with the operation of the 710, review the **SHOCK HAZARD** at the front of this manual.

4.1.1 The 710 measures frequency from 10 Hz to in excess of 60 MHz. The following contains all the information related to the operation of the Instrument. Special notes and instructions have also been provided for added safety and convenience.

4.2 SAFETY PRECAUTIONS

4.2.1 The 710 is designed to be used only by personnel qualified to recognize shock hazards and trained in the safety precautions required to avoid possible injury.

4.2.2 Do not work alone when making measurements where a shock hazard can exist. Notify a nearby person that you are, or intend to make such measurements.

Operation

4.2.3 Do not exceed the maximum input voltage ratings of the 710 which are tabulated in Table 1-1. To do so endangers personal safety and may also damage the Instrument.

WARNING



The input BNC connector is not grounded. To avoid electrical shock, connect the outer shell of the input BNC connector only to ground potential or to a potential no greater than 42.4 volts peak (30 VRMS) with respect to ground.

4.2.4 Observe the correct polarity when making connections, as the input connector outer shell is not grounded to the powerline.

Remember: Voltage might appear unexpectedly in defective equipment. An open bleeder resistor can result in a capacitor retaining a dangerous charge. Remove all power and discharge all capacitors in the circuit being measured before making connections or disconnections.

4.2.5 Locate all voltage sources prior to making any connections. Do not touch leads, circuits, or the Instrument, while power is applied to the circuit being measured. Always inspect leads and connectors for cracks, breaks or crazes before each use. If any defects exist, replace the defective item immediately.

4.2.6 Use extreme caution when making measurements in a circuit where a dangerous combination of voltages could be present, such as in an r-f amplifier.

4.3 FREQUENCY MEASUREMENT PROCEDURE:

- Review Safety Information in Paragraphs 4-1 and 4-2.
- Depress POWER pushbutton switch to ON position.
- Select MHz (2) or Hz (3) for desired count time or base time.
- Connect signal being measured to Input Connector (5) while signal source is off. (Refer to paragraph 4.2.3)
- Read frequency from display (7). Decimal point is correctly positioned, and correct measurement unit (MHz, Hz) is indicated by the depressed MHz or Hz pushbutton switch.
- Depress filter (4) to IN position to eliminate high frequency noise on low frequency signals.

4.4 APPLICATION

4.4.1 C.B. Frequency Measurements:

- Connect the circuit shown in the diagram on page 4-4.
- Select the desired C.B. channel to be measured.
- Depress the MHz pushbutton switch IN for frequency measurement in MHz or Hz pushbutton switch for measurement in Hz.
- Turn C.B. unit and 710 ON.
- Key in the microphone without speaking into it. The carrier frequency will be displayed in the 710.

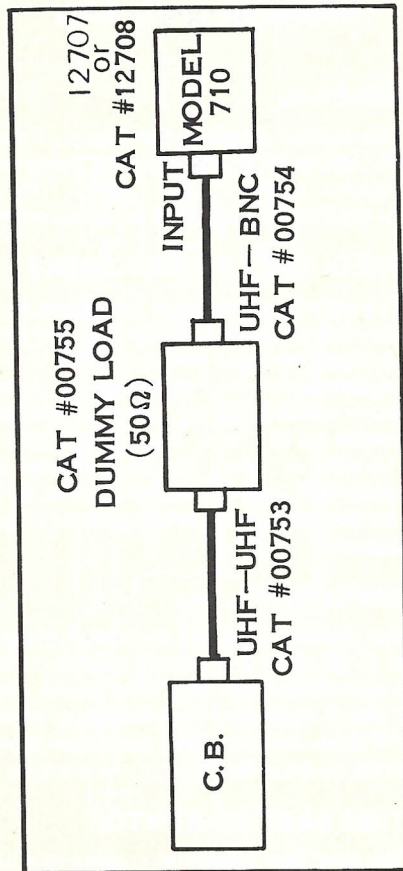

SECTION V

THEORY OF OPERATION

5.1 GENERAL

5.1.1 This section describes the theory of operation of the 710. All modes of operation are described first, then, description of the circuits follows. (Figure 5-1 shows the overall block diagram of the Instrument).

5.2 FREQUENCY MEASUREMENT

5.2.1 This circuit arrangement (as shown in Figure 5-1) permits control of the Gate by time base generator signals. The Gate is opened for a controlled time; therefore, the accumulated count represents the number of input cycles or pulses during this time. Controlled interval is selectable by the front panel pushbutton switch either in 10 mSec or 1 sec. The decimal point is automatically positioned, and the readout is in Hz, or MHz as indicated by the pushbutton switch position (Figure 6-1 Timing Diagram).

5.3 AMPLIFIER

5.3.1 The amplifier (Figure 5-1) consists of a junction field-effect (high input impedance) transistor; AC coupled to a wide-band, linear-integrated circuit amplifier. Sufficient gain is maintained for a frequency response of 10 Hz to 60 MHz. Input overload protection is provided by two silicon diodes at the input of the amplifier.

5.4 TIME BASE GENERATOR

5.4.1 The time Base Generator consists of a high stability crystal oscillator and frequency divider providing

Theory of Operation

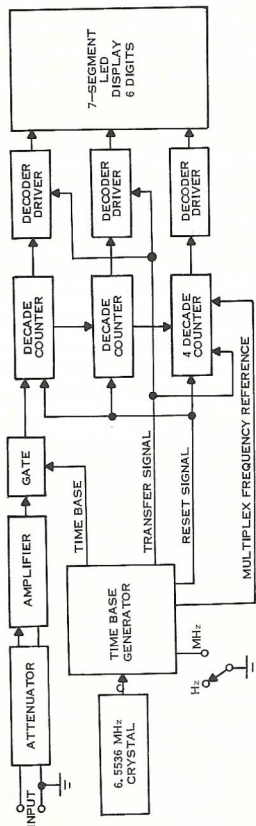

Figure 5-1. Block Diagram

Theory of Operation

the gating signals for the count window, store function, reset function and Multiplex frequency reference. The duration of the count window may be selected by the front panel pushbutton switch for either 10 mSec or 1 sec.

5.5 GATE AND GATE CONTROL CIRCUITS

5.5.1 The Gate is a "NAND" gate which consists of a 2-input integrated circuit whose function is to control the input pulses to the Decade Counters. In frequency measurement, the signal being measured appears at one input. The time-base signal (duration selected by the MHz or Hz switch), acts as the controlling elements, and appears at the other input.

WARNING

These servicing instructions are for use by qualified personnel only. To avoid electrical shock, do not perform any servicing other than that contained in the operating instructions unless you are qualified to do so.

SERVICING INSTRUCTIONS

6.1 GENERAL

6.1.1 This section of the manual describes the line voltage, instrument cover removal, and calibration necessary for servicing the 710. (Table 6-1 lists the typical power supply voltages.)

6.2 LINE VOLTAGE

6.2.1 During the performance checks, the adapter shall be connected to a power source through a variable voltage device. This procedure enables the line voltage to be varied $\pm 10\%$ from 120 VAC or $\pm 15\%$ from 230 VAC, thus assuring satisfactory performance under various supply conditions.

6.3 INSTRUMENT COVER REMOVAL

WARNING

Remove all power and connections to the instrument prior to removing the rear cover. Do not operate the instrument with the rear cover removed.

6.3.1 The following steps shall be taken when removing the instrument cover:

- a. Depress the POWER switch to the OFF position.

- b. Disconnect the adapter from the Instrument and input leads from Input BNC connector.
- c. Turn the two screws on the back cover counter-clockwise until the rear cover is removed. (The two screws will remain in the cover.)
- d. Reverse this procedure when replacing the cover.

6.4 CALIBRATION

6.4.1 To calibrate the 710 perform the following procedures:

- a. Plug adapter into an appropriate power source. Turn power "on" and allow one hour warm-up.
- b. Remove the rear panel. Depress the "Hz" switch on front panels.
- c. Connect the input connector of the 710 to a precision frequency standard of 10 MHz with accuracy better than ± 1 PPM.
- d. Using an insulated screwdriver, adjust the trimmer capacitor, C, to allow the unit to read: 000000 ± 1 counts with the OVERRANGE indicator on.
- e. Replace the rear panel.

Table 6-1. Typical Power Supply Voltage

POWER SUPPLY	VOLTAGE*	RIPPLE
+5V CIRCUIT Pin #2 of IC 15	4.8 — 5.2V	30mV p-p

*The above voltage is a typical value and will vary with component tolerances and line voltage.

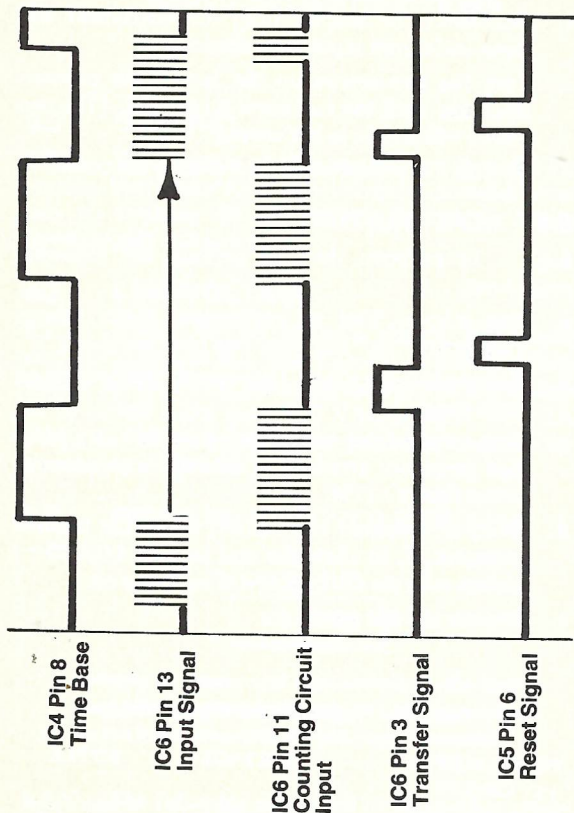

Figure 6-1. Timing Diagram Frequency Measurement shown in Hz position)

6.5 REPLACEMENT PARTS AND SCHEMATIC DIAGRAM

NOTE: This Instrument must be serviced by qualified personnel. To aid in troubleshooting a schematic diagram is enclosed. The accompanied parts list (Table 6-1) describes the components and refers to Simpson part numbers. Reference Symbol numbers correlate the components shown on the schematic diagram with the parts list.

6.5.1 The following information is provided as an adjunct to the overall text contained in this manual and should be read and understood thoroughly prior to ordering replacement parts for this Instrument.

6.5.2 To obtain replacement parts, address order to the nearest Authorized Service Center (listed on the last pages of this manual). Refer to paragraph 2.5.1 for ordering instructions.

Table 6-2. Replacement Parts

Symbol	Description	Part No.
	Board P.C. Main	6-110354
	Board P.C. Readout	6-110355
C1	Capacitor, 220 pf 500V	5-112691
C2	Capacitor, .22 μ f 250V	6-110364
C3	Capacitor, 62 pf 500V	5-116187
C4,8,10,	Capacitor, 15 μ f 16V	5-115534
18		
C5,7,9,	Capacitor, .001 μ f 25V elect.	5-111119
14		
C6,20	Capacitor, 100 μ f 16V	5-117737
C10	Capacitor, 15 μ f 16V	5-115534
C11	Capacitor, Trimmer, 2-10pf	5-118190

Replacement Parts

C12	Capacitor, 25 pf 1kV	5-117609
C13	Capacitor, 39pf 1kV	5-118561
C15	Capacitor, .022 μ f 100V	5-116188
C16,17	Capacitor, .01 μ f 50V	5-113215
C19,21	Capacitor, .1 μ f 10V	5-113214
D1,2	Diode 1N914	5-112004
IC1	Line Receiver IC10116B	6-110372
IC2	Oscillator Control ICM7207	6-110371
IC3	Decade Counter DM74C90N	6-110370
IC4	Quad 2 Input Gate DM74L00N	5-115471
IC5	Dual 4 Input Gate DM74C20N	5-118311
IC6	Quad 2 Input Gate 74S00N	5-117146
IC7	Decade Counter N82S90	5-117147
IC8,10, 12	Decoder-Driver MC14511CP	5-119927
IC9	Decade Counter DM7490N	5-114939
IC11	4½ Digit Counter HCTR6010	5-119506
IC13	Dual D.F.F. DM74C74	5-118312
IC14	+5V Regulator 7805	5-117149
IC101	Mos LED Hex Driver 75492	5-119928
Q1	N-FET 2N4416	6-110373
Q2,6	PNP Transistor 2N4248	5-115484
Q3,4	NPN Transistor 2N5771	5-117827
Q5	NPN Transistor GET 2222	5-115934
R1	Resistor, 4.7 Ω \pm 5% ½W	5-118609
R2,3	Resistor, 1M Ω \pm 5% ¼W	5-118305
R4*	Potentiometer, 100 Ω \pm 20%	6-110450
R5	Resistor, 180 Ω \pm 5% ¼W	5-118153
R6,17	Resistor, 160 Ω \pm 5% ¼W	6-110362
R7	Resistor, 130 Ω \pm 5% ¼W	6-110361
R8	Resistor, 470 Ω \pm 10% ¼W	1-116372
R9	Resistor, 10 Ω \pm 5% ¼W	5-115117
R10,11, 12,13	Resistor, 270 Ω \pm 10% ¼W	5-114969
R14,15	Resistor, 510 Ω \pm 5% ¼W	5-114965
R16	Resistor, 39 Ω \pm 5% ¼W	6-110360

Replacement Parts

R18,21, 22,23, 27,28,51	Resistor, 10k Ω \pm 5% ¼W	5-118161
R19,24, 26	Resistor, 4.7k Ω \pm 5% ¼W	5-118160
R20	Resistor, 1k Ω \pm 5% ¼W	5-118155
R25	Resistor, 100k Ω \pm 5% ¼W	5-118168
R29-R42	Resistor, 680 Ω \pm 5% ¼W	6-110363
R43-R49	Resistor, 62 Ω \pm 5% ¼W	5-118499
R50	Resistor, 47k \pm 10% ¼W	5-113628
	Bracket, Power Connector	6-160359
	Cable, Fabricated, 7 Cond. Ribbon	3-812469
	Shield, Amplifier	6-160353
	Button, Push, Gray	6-110115
	Button, Push, Black	6-110114
	Button, Push, Red	6-110113
	Switch, Pushbutton, 4 Station	6-110358
	Crystal, 6.55360 MHz	6-110356
	Diode, Light Emitting, Red	5-119411
	Readout, LED, 7 Segment, w/Dec. Point	6-110366

AUTHORIZED SERVICE CENTERS

SIMPSON ELECTRIC COMPANY

853 Dundee Avenue, Elgin, Illinois 60120 — Phone: (312) 697-2260

* Parts Sales & Repair Service Only

** Parts, General Test Equipment & Panel Instrument Sales & Service

*** Same Service As (**) Above Plus Panel Instrument Modification

*** Additionally Authorized for Service on Recorders, Controllers, Digital Products and Lab Portables

***ALABAMA, MOBILE 36817
 BROWNELL-ELECTRO INC.
3450 Armour Drive
Tel. 205/479-8581

**ALASKA, ANCHORAGE 99501
YUKON RADIO SUPPLY, INC.
3222 Commercial Drive
P.O. Box 406
Tel. 907/277-1497

**ALASKA, ANCHORAGE 99500
R. M. ZOOK & ASSOCIATES
1710 E. 27th Avenue
Tel. 907/272-6917

**ALASKA, FAIRBANKS 99701
YUKON RADIO SUPPLY, INC.
1112 Cushman Street
Tel. 907/452-1011

***ARIZONA, PHOENIX 85040
 METERMASTER INC.
4134 E. Wood Street
Tel. 602/243-4111

***CALIFORNIA, GLENDALE 91201
 WEATHERFORD INSTRUMENT DIV.
WESTERN ELECTRONIC SUPPLY CORP.
640 Alton Street
Tel. 213/246-4861

**CALIFORNIA, LOS ANGELES 90040
 E.I.L. INSTRUMENTS INC.
6212 Peachtree St.
Tel. 213/685-7020

***CALIFORNIA, LOS ANGELES 90040
 METERMASTER, INC.
5646 Jilison Street
Tel. 213/685-4940

***CALIFORNIA, PALO ALTO 94303
 METERMASTER, INC.
3995 E. Bayshore Road
Tel. 415/968-0313

***CALIFORNIA, SAN DIEGO 92123
 METERMASTER/SAN DIEGO
8799 Balboa Avenue
Tel. 714/560-4841

**CALIFORNIA, SAN FRANCISCO 94105
PACIFIC ELECTRICAL
INSTRUMENT LAB
150 Folsom
Tel. 415/643-3104

**CALIFORNIA, SANTA CLARA 95050
 FISHER-BROWELL
3381 Edward Avenue
Tel. 408/988-6041

**CALIFORNIA, SOUTH PASADENA 91030
 ETALON COMPANY
1323 Huntington Drive
Tel. 213/257-5410

**COLORADO, DENVER 80223
 METER MASTER INSTRUMENT
CORPORATION
1165 S. Cherokee
Tel. 303/722-5766

**CONNECTICUT, MIDDLETOWN 06457
 THE MANCIB COMPANY
Subsidiary of E.I.L. Instruments
Randolph Road and Coe
Tel. 203/346-6646

**FLORIDA, MIAMI 33136
FLORIDA PRECISION INSTRUMENT
COMPANY
800 N.W. 7th Avenue
Tel. 305/324-1731

**FLORIDA, MIAMI 33142
 KIMBALL ELECTRONIC LAB., INC.
3620 N.W. 48 Terrace
Tel. 305/635-9712

**FLORIDA, ORLANDO 32806
 BROWNELL-ELECTRO INC.
307 27th St., Box 6945
Tel. 305/843-6775

**FLORIDA, TAMPA 33614
TAMPA INSTRUMENTATION CENTER
A.C. FERNANDEZ ELECTRIC
4807 N. Church Avenue
Tel. 813/670-0183

**GEORGIA, ATLANTA 30354
 BROWNELL-ELECTRO INC.
3020 Commerce Way
Tel. 404/762-5181

**HAWAII, HONOLULU 96819
EMC CORPORATION
2979 Ualeña Street
Tel. 808/847-1138

**HAWAII, HONOLULU 96819
KEMS INCORPORATED
239 Puuhale Road
Tel. 808/847-1395

**ILLINOIS, BRIDGEVIEW 60455
E.I.L. INSTRUMENTS, INC.
9708 Industrial Drive
Tel. 312/430-2292

**ILLINOIS, ELK GROVE VILLAGE 60007
METERMASTER, INC.
121 Gordon Street
Tel. 312/593-8650

**ILLINOIS, OAK PARK 60302
PACIFIC INDICATOR COMPANY
6603 W. North Avenue
Tel. 312/281-1330

**INDIANA, EVANSVILLE
 ELECTRO-LAB SERVICES INC.
1302 N. Fulton 47710 (UPS)
P.O. Box 5011 47712 (MAIL)
Tel. 812/423-5211

**KANSAS, OVERLAND PARK 66206
BROOKS ELECTRONICS INC.
3761 W. 95th Street
Tel. 913/648-9331

**KANSAS, WICHITA 67211
 MAIN ELECTRONICS INC.
225 Ida
Tel. 316/267-3581

**LOUISIANA, HARAHAN 70123
 INDUSTRIAL INSTRUMENT WORKS
134 Lafram Lane
Tel. 504/733-9355

**MARYLAND, ELK RIDGE 21227
 SUNSHINE SCIENTIFIC
INSTRUMENTS, INC.
5800 Main Street
Tel. 301/798-9600

**MARYLAND, GAITHERSBURG 20706
 PIONEER/INSTRUMENTATION
Div. of Pioneer Standard
Electronics Inc.
9100 Gaither Road
Tel. 301/948-0710

**MARYLAND, SAVAGE 20863
 INSTRUMENT SPECIALTIES INC.
Div. of Pytronic Ind.
8220 Wellmourt Court
Tel. 301/792-0780

**MARYLAND, TIMONIUH 21093
 E.I.L. INSTRUMENTS, INC.
1830 York Road
Tel. 301/252-1260

**MASSACHUSETTS, BILLERICA 01821
METERMASTER, INC.
13 Fortune Drive
Tel. 617/667-8346

**MASSACHUSETTS, BURLINGTON 01803
 THE MANCIB COMPANY
Subsidiary of E.I.L. Instruments Inc.
21 "A" Street
Tel. 617/272-9450

**MICHIGAN, FERNDALE 48220
 RAW METER, INC.
1100 Hilton Road
Tel. 313/398-6767

***MINNESOTA, MINNEAPOLIS 55427
 INSTRUMENTATION SERVICES INC.
957 Winnetka Avenue North
Tel. 612/544-8916

**MISSOURI, ST. LOUIS 63108
 INDUSTRIAL SERVICE
LABORATORIES CORP.
4354 Olive Street
Tel. 314/535-5760

**MISSOURI, ST. LOUIS 63143
 SCHERRER INSTRUMENTS INC.
7170 Manchester
Tel. 314/644-5362

**MONTANA, BILLINGS 59102
INDUSTRIAL ELECTRONICS &
AUTOMATION COMPANY
2500 Grand Avenue
Tel. 406/656-1313

**NEBRASKA, LINCOLN 68508
ELECTROMETRICS COMPANY
404 South 11th
Tel. 402/477-3434

**NEW JERSEY, BELLEVILLE 07109
MARSHALL INSTRUMENTS INC.
235 Washington Avenue
Tel. 201/751-1190

**NEW JERSEY, SOUTH
PLAINFIELD 07080
BROWNELL-ELECTRO INC.
500 Hiedley Road
Tel. 201/753-4600

**NEW MEXICO, ALBUQUERQUE 87102
 MISSOURI RESEARCH LAB, INC.
530 Haines Avenue NW
Tel. 505/243-6772

**NEW YORK, CHADWICKS 13319
MOHAWK COMMUNICATIONS
3500 Bleachery Place
Tel. 518/373-7328

**NEW YORK, CHADWICKS 13319
MOHAWK COMMUNICATIONS
3500 Bleachery Pl.
Tel. 518/373-7328

**NEW YORK, CLARENCE 14031
 TROTT ELECTRONICS INC.
9020 Wehrle Drive
Tel. 716/634-8500

**NEW YORK, NEW YORK 10011
BROWNELL-ELECTRO INC.
Tel. 212/924-6000

**NEW YORK, NEW YORK 10011
 NILSSON ELECTRICAL
LABORATORY, INC.
111 8th Avenue — Rm. 1525
Tel. 212/675-7944

**NEW YORK, ROCHESTER
 ELECTRONIC INSTRUMENT COMPANY
325 Mt. Read Blvd.
Tel. 716/328-4350

**NORTH CAROLINA, CHARLOTTE 28216
 BROWNELL-ELECTRO INC.
6141 Belhaven Blvd.
Box #16368
Tel. 704/394-4341

NOTES

- ***NORTH CAROLINA, RALEIGH 27612
 INSTRUMENT TECHNICAL REP.
 Rt. 8 — Box 115-C1
 Umstead Industrial Park
 Tel. 919/781-3256
- ***OHIO, CLEVELAND 44105
 PIONEER/INSTRUMENTATION
 INSTRUMENT LABORATORY
 Div. of Pioneer-Standard Electronics, Inc.
 4800 East 131st Street
 Tel. 216/587-3600
- ***OHIO, CLEVELAND 44135
 WESCHLER ELECTRIC CORP.
 16900 Foltz Parkway
 Tel. 216/238-2550
- ***OHIO, COLUMBUS 43229
 CONTRONICS, INC.
 835 Busch Court
 Tel. 614/846-5930
- ***OHIO, DAYTON 45404
 PIONEER/DAYTON
 Div. of Pioneer-Standard Electronics, Inc.
 1900 Troy Street
 Tel. 513/236-9900
- ***OKLAHOMA, OKLAHOMA CITY 73107
 HUSTON LABORATORIES, INC.
 536 No. Pennsylvania
 Tel. 405/295-5489
- ***OKLAHOMA, TULSA 74120
 AGRA ENGINEERING COMPANY
 551 S. Quaker Avenue
 Tel. 918/84-4235
- ***OREGON, PORTLAND 97217
 WESTCON, INC.
 5101 N. Interstate
 Tel. 503/283-0132
- ***PENNSYLVANIA, PHILADELPHIA 19115
 SUNSHINE SCIENTIFIC
 INSTRUMENTS INC.
 1810 Grant Avenue
 Tel. 215/673-5600
- ***PENNSYLVANIA, PITTSBURGH 15238
 CAM/RPC
 620 Alpha Drive RIDC Pk.
 Tel. 412/782-3770
- ***PENNSYLVANIA, PITTSBURGH 15221
 E.I.L. INSTRUMENTS, INC.
 1844 Ardmore Blvd.
 Tel. 412/731-5230
- ***TENNESSEE, MEMPHIS 38116
 BROWNELL-ELECTRO INC.
 3053 Tranquility Drive
 Tel. 901/332-8258
- ***TENNESSEE, MEMPHIS 38104
 INSTRUMENT REPAIR SERVICE
 468 N. Watkins
 Tel. 901/278-0762
- ***TENNESSEE, NASHVILLE 37210
 BROWNELL-ELECTRO INC.
 1050 Acorn Drive
 Tel. 615/889-8230
- ***TEXAS, DALLAS 75220
 ULTRA INSTRUMENT LAB., INC.
 9995 Monroe
 Tel. 214/357-0297
- ***TEXAS, EL PASO 79901
 BORDER ELECTRONICS
 1704 E. Paisano Drive
 Tel. 915/532-2524
- ***TEXAS, GARLAND 75040
 METERMASTER, INC.
 2809 National Drive
 Tel. 214/271-5671
- ***TEXAS, HOUSTON 77006
 ELECTRICAL INSTRUMENT METER
 COMPANY (EIMCO)
 1424 Westheimer
 Tel. 713/528-8871 & 72
- ***TEXAS, HOUSTON 77023
 METERS & INSTRUMENTS CORP.
 6428 Gulf Freeway
 Tel. 713/644-1631
- ***TEXAS, ODESSA 79760
 METER SERVICE & SUPPLY
 2127 Kermit Highway
 P.O. Box 2373
 Tel. 915/332-0565
- ***TEXAS, ODESSA 79760
 WHITLOCK INSTRUMENT
 1306 North Texas
 Tel. 915/337-3412
- ***VIRGINIA, ALEXANDRIA 22312
 E.I.L. INSTRUMENTS, INC.
 5400 Cherokee Avenue
 Tel. 703/354-4330
- ***VIRGINIA, CHESAPEAKE 23325
 INSTRUMENT TECHNICAL REP.
 1835 Lockhard Street
 Tel. 804/424-5121
- ***VIRGINIA, RICHMOND 23234†
 ***VIRGINIA, CHESTERFIELD 23831††
 INSTRUMENT TECHNICAL
 REPRESENTATIVES
 7400 White Pine Road
 Tel. 804/275-1431
- ***WASHINGTON, SEATTLE 98105
 EICHER-RICHARDS COMPANY
 2727 N.E. Blakeley Street
 Tel. 206/523-7888
- ***WASHINGTON, SEATTLE 98108
 E.I.L. INSTRUMENTS, INC.
 1312 S. 96th Street
 Tel. 206/762-0880
- ***WASHINGTON, SPOKANE 99202
 BLACKS-INDUSTRIAL INC.
 N. 401 Helena
 P.O. Box 3286
 Tel. 509/535-1504
- ***WISCONSIN, MILWAUKEE 53202
 THE ELECTRO MECHANO COMPANY
 241 East Erie Street
 Tel. 414/272-4050
- ***WYOMING, LANDER 82520
 METER SPECIALISTS, INC.
 P.O. Box 595 (MAIL)
 Hwy 287 West (UPS)
 Tel. 307/332-9711

† Regular Mail Delivery

†† UPS Delivery

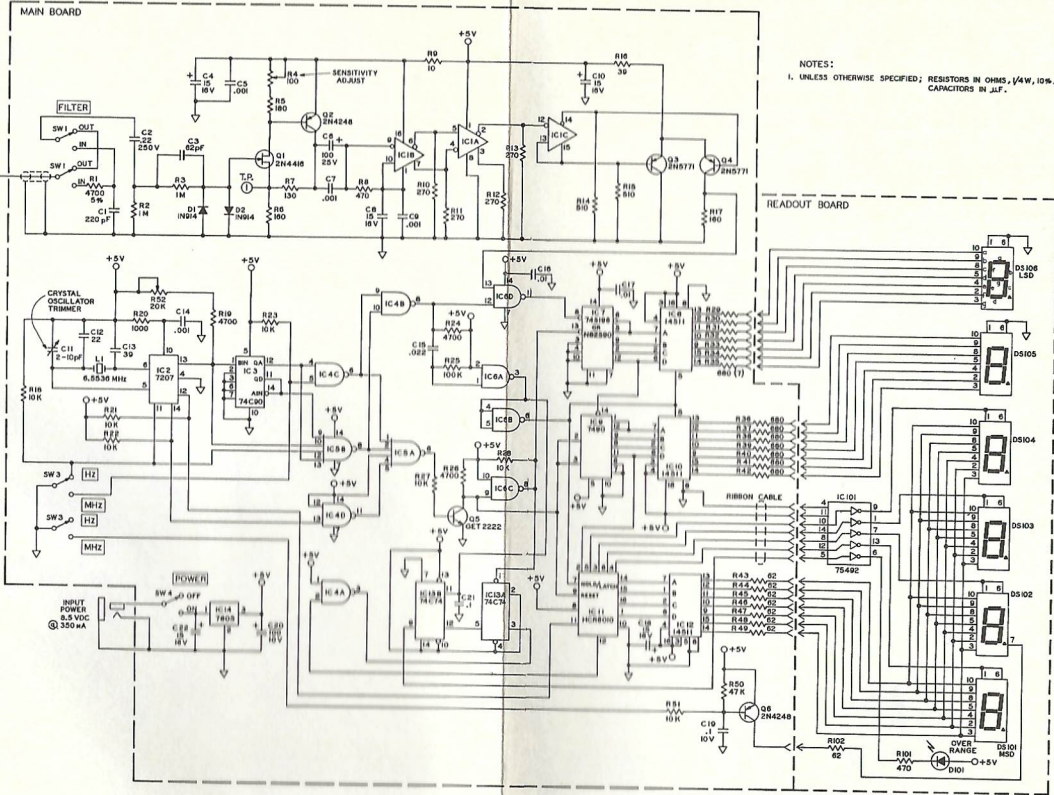

Schematic Diagram