

**LDG KT-100 100-Watt
Automatic Tuner for
Kenwood Transceivers**



LDG Electronics

1445 Parran Road
St. Leonard MD 20685-2903 USA

Phone: 410-586-2177

Fax: 410-586-8475

ldg@ldgelectronics.com

www.ldgelectronics.com

Table Of Contents

Introduction	2
Jumpstart, or “Real hams don’t read manuals!”	2
Specifications	2
An Important Word About Power Levels	2
Important Safety Warning	2
Getting to know your KT-100	2
<i>Front Panel</i>	2
<i>Rear Panel</i>	2
Installation	2
Operation	2
<i>Basic Tuning Operation</i>	2
<i>Operation From the Kenwood Transceiver Front Panel</i>	2
<i>Typical Location of AT Tuning Button on Kenwood Transceivers</i>	2
<i>Operation From the KT-100 Front Panel</i>	2
<i>Tuning on the 6 Meter Band</i>	2
<i>Status Indicators</i>	2
<i>Configuration Options</i>	2
Operating Hints	2
<i>Transceiver Tuner Status Indication</i>	2
<i>Transceiver Tuner “Time-Out” Beep</i>	2
<i>TS-50 Hints</i>	2
<i>TS-2000 Hints</i>	2
<i>TS-480 HX Hints</i>	2
<i>TS-480 SAT Hints</i>	2
<i>TS-450 / TS-690 Hints</i>	2
<i>TS-570 Hints</i>	2
<i>TS-850 Hints</i>	2
<i>TS-870 Hints</i>	2
Application Information	2
<i>Mobile Operation</i>	2
<i>MARS/CAP Coverage</i>	2
Theory of Operation	2
<i>Some basic ideas about impedance</i>	2
<i>Transmitters, transmission lines, antennas, and impedance</i>	2
The LDG KT-100	2
A Word About Tuning Etiquette	2
Care and Maintenance	2
Technical Support	2
Two-Year Transferrable Warranty	2
Out Of Warranty Service	2
Returning Your Product For Service	2
Product Feedback	2

INTRODUCTION

LDG pioneered the automatic, wide-range switched-L tuner in 1995. From its laboratories in St. Leonard, Maryland, LDG continues to define the state of the art in this field with innovative automatic tuners and related products for every amateur need.

Congratulations on selecting the KT-100 100-watt automatic tuner for Kenwood transceivers. The KT-100 provides semi-automatic antenna tuning across the entire HF spectrum plus 6 meters, at power levels up to 125 watts. It will tune dipoles, verticals, Yagis, or virtually any coax-fed antenna. It will match an amazing range of antennas and impedances, far greater than some other tuners you may have considered, including the built-in tuners on many Kenwood radios.

The KT-100 is similar to previous LDG tuners, but is specially engineered to integrate with your Kenwood HF radio. The KT-100 connects to the Kenwood AT-300 tuner port on the back of the radio. Not only is the KT-100 controlled by the radio, it also is powered by the radio, so there is no additional power cable required to use the KT-100!

JUMPSTART, OR “REAL HAMS DON’T READ MANUALS!”

Ok, but at least read this one section before operating the KT-100:

1. Turn off power to your Kenwood radio.
2. Connect the antenna jack (Antenna “1” on TS-480) on your transceiver to the “TX” jack on the KT-100, using the supplied 50 ohm coax cable jumper.
3. Connect a 50 ohm coax antenna feedline to the “ANT” jack on the KT-100.
4. Connect the 6-pin end of the supplied radio interface cable to the Antenna Tuner port on the back of your Kenwood radio.
5. Connect the 7-pin mini-DIN plug end of the supplied radio interface cable to the “Radio” jack on the back of the KT-100.
6. Turn on power to your transceiver and select the desired operating frequency and mode.
7. Push and hold the AT or TUNE button on the front of your transceiver for one second¹. The transceiver automatically switches to CW mode, and keys up with a minimal amount of power, and the KT-100 begins a tuning cycle. At the end of the tuning cycle, the original mode and power level is restored.
8. Wait for the tuning cycle to end; you’re now ready to operate!

¹ Note: Tuning on the 6 meter band requires a different procedure; see section xxxxx

SPECIFICATIONS

- 0.1 to 125 watt power range (SSB and CW), 100W on 6M.
- Latching relays for ultra low power operation.
- 2000 memories for instantaneous band changing.
- Controlled from Kenwood Tuner button on radio. Powered from Kenwood radio.
- Works with any Kenwood radio that is AT-300 compatible.
- Partial radio list: TS-50, TS-480², TS-570, TS-690, TS-850, TS-870, TS-2000.
- Tuning time: 0.1 to 6 seconds full tune, 0.1 seconds memory tune.
- 1.8 to 54.0 MHz coverage. Built-in frequency sensor.
- Tunes 4 to 800 ohm loads (16 to 150 on 6M), 16 to 3200 ohms with optional 4:1 Balun.
- For Dipoles, Verticals, Vees, Beams or any Coax Fed Antenna.
- Optional external Balun allows tuning of random length, long wire or ladder line fed antennas.
- Includes Kenwood interface cable and coax jumper. Ready to use right out of the box.
- Dimensions: 6.5L” x 6.5W” x 1.5H”.
- Weight: 2 pounds

AN IMPORTANT WORD ABOUT POWER LEVELS

The KT-100 is rated at 125 watts maximum power input *at most*. Many ham transmitters and transceivers, and virtually all amplifiers, output well over 125 watts. Power levels that significantly exceed specifications will definitely damage or destroy your KT-100. If your tuner fails during overload, it could also damage your transmitter or transceiver. Be sure to observe the specified power limitations.

IMPORTANT SAFETY WARNING

Never install antennas or transmission lines over or near power lines. You can be seriously injured or killed if any part of the antenna, support or transmission line touches a power line. Always follow this antenna safety rule: the distance to the nearest power line should be at least twice the length of the longest antenna, transmission line or support dimension.

² Note: When using the KT-100 with TS-480 HX (200 watt radio), the TS-480HX will only transmit 100 watts. The TS-480HX is programmed by Kenwood to limit the power to 100 watts when an external tuner is detected. LDG recommends the AT-200 Pro for use with the TS-480HX, so that the full 200 watts may be realized.

GETTING TO KNOW YOUR KT-100

Your KT-100 is a quality, precision instrument that will give you many years of outstanding service; take a few minutes to get to know it.

The KT-100 can be used with any Kenwood transceiver that supports the AT-300 tuner interface. Tuning is performed when the AT or TUNE button is pushed on the front of the Kenwood radio and held for one second. The tuner can be placed in bypass mode by pressing the AT or TUNE button momentarily.

Front Panel



On the front panel there is one pushbutton and two LED indicator lights.

- **Tune:** Initiates either a memory tune or a full tune, and also toggles the tuner between “active” and “bypass” modes.
- **SWR LED:** Lights steady green at the end of a tuning cycle to indicate a good match has been found.
- **Tuning LED:** Lights during tuning operation, will also blink error codes if a good tuning match is not found.

Rear Panel

The rear panel of the KT-100 features four connectors.



- **ANT connector:** Connect the 50-ohm coax antenna feedline to this standard SO-239 connector.
- **GND connector** (wing nut): Connect to antenna system ground.
- **TX connector:** Connect the 50-ohm coax jumper cable from this standard SO-239 connector to the ANT jack on the back of the transceiver.
- **Radio connector:** This 7-pin mini-DIN connector connects to the supplied radio interface cable, which connects to the AT-300 tuner port on the transceiver.

INSTALLATION

The KT-100 tuner is designed for indoor operation only; it is not water resistant. If you use it outdoors (Field Day, for example), you must protect it from the rain. The KT-100 is designed for use with coax-fed antennas. If use with longwires or ladder-line-fed antennas is desired, an external balun is required. The LDG RBA-4:1 or RBA-1:1 is ideal, depending on the antenna and transmission line used.

Always turn your radio off before plugging or unplugging anything. The radio may be damaged if cables are connected or disconnected while the power is on.

Connect the HF antenna jack on the transceiver to the **TX** jack on the back of the KT-100, using the supplied coax jumper cable, or a similar 50 ohm coax cable rated 125 watts or greater. On the TS-480 and TS-2000 radios, the KT-100 must be connected to the **ANT 1** jack of the transceiver. The TS-480 and TS-2000 will not initiate an external tuning cycle if ANT 2 is selected. The internal tuner will be used, instead, on those models equipped with an internal tuner, such as the TS-480SAT and TS-2000. On models without an internal tuner, pressing AT while ANT 2 is selected will have no effect.

Connect the supplied radio interface cable to the mini-DIN 7-pin jack on the rear of the KT-100, marked "**Radio**". Connect the other end of this cable to the six-pin AT-300 interface port on

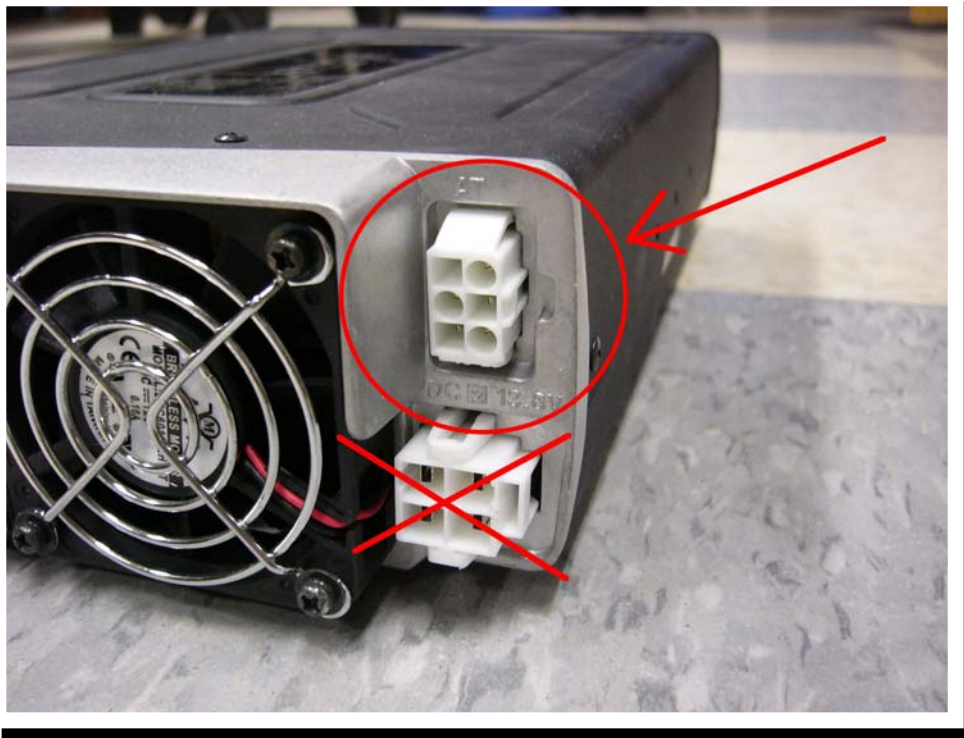

the rear of the transceiver. That connector looks like this:

Grounding the KT-100 tuner will enhance its performance and safety. LDG recommends that you connect your tuner to a suitable ground; a common ground rod connected to buried radials is

preferred, but a single ground rod, a cold water pipe, or the screw that holds the cover on an AC outlet can provide a serviceable ground. LDG strongly recommends the use of a properly installed, high quality lightning arrestor on all antenna cables.

OPERATION

Basic Tuning Operation

The KT-100 is operated either from the AT / TUNE button on the Kenwood transceiver, or from the front panel TUNE button on the KT-100 itself. Two types of tuning cycles are available; a memory tuning cycle and a full tuning cycle.

The **memory tuning cycle** attempts to tune quickly based on having previously tuned on the present frequency selection. If the tuner previously was successful in tuning on the currently selected frequency, the settings for that match will be loaded into the tuner relays, and checked to see that an acceptable SWR match is found.

A **full tuning cycle** “starts from scratch” and begins a fixed tuning sequence where the KT-100 rapidly tries varying combinations of inductance and capacitance values, and then zeroes-in on the best match possible. When the tuning cycle is complete, if an acceptable match was found, the inductance and capacitance settings are saved in a memory associated with the selected frequency, so that they may be recalled quickly in the future via a memory tuning cycle.

In this manner, the KT-100 “learns”; the longer you use it, the more closely it adapts itself to the bands and frequencies you use. Most users will probably use memory tuning most of the time; it takes advantage of any saved tuning settings, but automatically defaults to a full tuning cycle if no stored data is available.

In both cases, at the end of the tuning cycle, the carrier is held for 1.5 seconds after tuning is complete, so that the final SWR may be read on the transceiver’s internal SWR meter or another inline SWR meter, and the front panel LEDs will indicate the status of the tuning cycle.

Operation From the Kenwood Transceiver Front Panel

To initiate a tuning sequence from the Kenwood transceiver, press and hold the AT button for one second. The radio will switch to CW mode, reduce power, and begin to transmit a carrier. The KT-100 will begin a memory tuning sequence as described above. If an acceptable SWR match is found in the memory tuning cycle, the tuning cycle ends. Otherwise, the KT-100 automatically begins a full tuning cycle in an attempt to find a good match. If the full tuning cycle is then successful, the match is stored in a memory associated with the selected frequency.

When the tuning cycle is complete, an indicator on the display of the transceiver will show that the tuner is active. This indicator varies by model; consult the transceiver owner’s manual for details on operation with an external automatic tuner.

To bypass the tuner via the Kenwood transceiver front panel, press the AT button momentarily. The red LED on the KT-100 will blink once to indicate it is in bypass mode. The tuning indicator on the front panel of the transceiver will also extinguish.

NOTE: On some models of Kenwood transceiver, an error beep may occur near the end of the tuning cycle, indicating the tuning cycle is taking a little longer than expected. This is normal and is no cause for alarm. The KT-100 matches a much broader range of antennas than Kenwood’s own tuners, and so may take a little longer to find a match.



Typical Location of AT Tuning Button on Kenwood Transceivers

Typically, the tuning button on the transceiver front panel is labelled “AT” or “TUNE”. The



following pictures show the location of this button on two popular Kenwood transceivers.



TS-480 “AT” Button location

TS-2000 “AT” Button location

Operation From the KT-100 Front Panel

Normally, the KT-100 is best operated from the transceiver front panel AT button, but there are certain circumstances in which operating from the KT-100 front panel gives more control. There are three operations which can be carried out by use of the front panel button on the KT-100: Toggle bypass mode, start a memory tune, or force a full tune:

- **Toggle Bypass Mode:** To toggle between bypassed and active mode, press the front panel **Tune** button on the KT-100 momentarily. The **Tuning LED** will flash once to indicate that the tuner is in bypass mode. Press the front panel **Tune** button momentarily again to recall the previous tuner settings. The **Tuning LED** will flash three times to indicate that the tuner is no longer bypassed. This function may be useful if you wish to compare antenna performance with and without the benefit of the tuner's matching network.

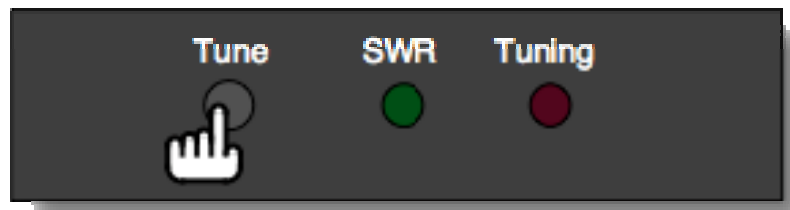

Momentary Press



1 Blink – Bypass

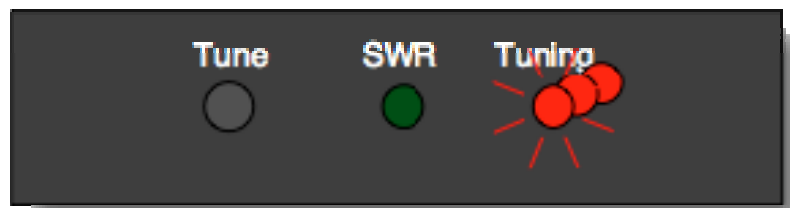

3 Blinks = Active

• **Initiate a Memory Tune Cycle:** To initiate a memory tuning cycle using the front panel of the KT-100, you must first change the radio's mode to one of the continuous carrier modes, such as AM, CW, or FM. Next, reduce output power to below 100 watts. Press and hold the **Tuning** button on the front of the KT-100 until the **Tuning LED** lights up. Release the button and key the transmitter. A memory tuning cycle will begin. When tuning is complete, you may return to the operating mode and power level previously set.

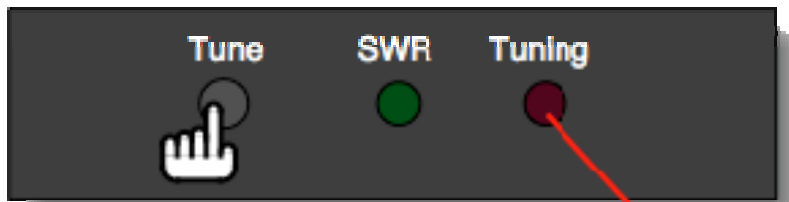

Press and hold until Tuning LED lights.



Release when Tuning LED lights to begin memory tune.

- **Force a Full Tune Cycle:** Sometimes, if you are transmitting on a previously tuned frequency, but something has slightly changed in your antenna system (maybe the antenna was re-oriented, for example), performing a memory recall tune will find a stored match that is acceptable, but is not as optimal as could be. In this case, forcing a full tune will cause the KT-100 to seek a better match than the match already stored in memory for this frequency.

To force a full tuning cycle, you must first change the radio's mode to one of the continuous carrier modes, such as AM, CW, or FM. Next, reduce output power to below 100 watts. Press and hold the **Tune** button on the front panel of the KT-100 until the **Tuning LED** lights up, and keep holding until the **Tuning LED** goes out again. Release the **Tune** button once the **Tuning LED** goes out, and then begin transmitting on the radio. A full tuning cycle will begin. When tuning is complete, you may stop transmitting and return the transceiver to its previous operating

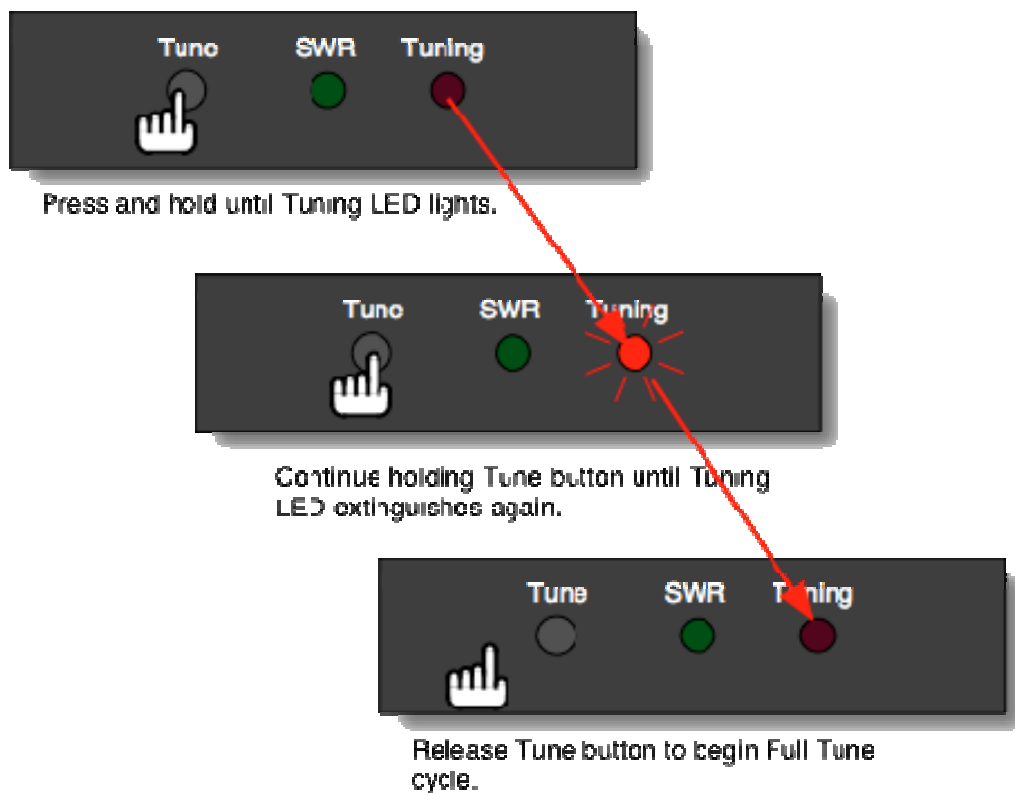

mode and power level.

Tuning on the 6 Meter Band

When Kenwood designed their own external antenna tuners, they did not include 6 meter operation, and so most Kenwood transceivers that are compatible with the KT-100 will not allow the pressing of the **AT** button to initiate a tuning cycle when operating on 6 meters. When tuning on the 6 meter band, follow the instructions for *Operation From the Front Panel of the KT-100* as shown beginning on page 10. In other words, when tuning on 6 meters, the KT-100 front panel button must be used.

Status Indicators

The **SWR LED** and **Tuning LED** are both used to indicate both operating modes, tuning status, and error codes. The following table lists the LED status codes and their meaning.

LED Indication	Meaning
Tuning LED blinks continuously.	No compatible Kenwood Transceiver is detected. Check interface cable connections.
Tuning LED on.	Tuner is tuning.
Tuning LED goes out, SWR LED comes on solid.	Tuner has completed a tuning cycle; a good SWR match was found.
Tuning LED goes out, SWR LED blinks 5 times.	Tuning cycle is complete, tuning match is between 1.5:1 and 3.0:1 SWR.
Tuning LED goes out, no SWR LED.	Tuning cycle is complete, tuning match is between greater than 3.0:1 SWR.
Tuning LED blinks 4 times.	Tuning cycle failed, no RF was detected.
Tuning LED blinks 5 times.	Tuning cycle failed, RF was lost in the middle of the tune.

Configuration Options

There are no configuration options for the KT-100. It's truly plug-and-play!

OPERATING HINTS

This section describes a few practical tips on using the KT-100 tuner with Kenwood transceivers.

Transceiver Tuner Status Indication

The various models of Kenwood transceivers all indicate the status of the external tuner a little differently. Most will show an graphical or textual icon on the screen to indicate that the tuner is engaged and has properly tuned. For example, the TS-480 displays a flashing “**R < AT > T**” while tuning, and a solid “**R < AT > T**” when tuning is complete. This icon disappears when the tuner is bypassed. Other Kenwood transceivers behave similarly. Consult your transceiver operating manual's section on use with external tuners for more information.

Transceiver Tuner “Time-Out” Beep

Certain models of Kenwood transceivers will begin beeping if a tuning cycle takes longer than a certain amount of time. This is normal with the KT-100, as some tuning cycles may last for several seconds.

TS-50 Hints

When using the KT-100 with a TS-50 transceiver, the radio will beep out the word “CHECK” (-.-. -.-. -.-) in Morse Code when the tuner is bypassed. This is normal.

TS-2000 Hints

When using the KT-100 with a TS-2000, be sure to hook the KT-100 to the **ANT 1** jack of the TS-2000. The internal tuner of the TS-2000 will still continue to function when **ANT 2** is selected.

TS-480 HX Hints

If using a TS-480HX with the KT-100, the TS-480HX will limit its transmit power to 100 watts maximum, on **both** antenna ports. LDG recommends using the AT-200 Pro instead.

TS-480 SAT Hints

When using the KT-100 with a TS-480SAT, hook the KT-100 to the **ANT 1** jack of the TS-480SAT. Set menu #27, “EXTERNAL AT OPERATION MODE” to “At1”. You will have to power off and back on for this setting to take effect.

TS-450 / TS-690 Hints

When using the KT-100 with the TS-450 or TS-690 radios, the radio will need to be configured to use an external tuner. To do this, hold down the **ENT** key when turning on the radio, then turn the **M.CH / VFO CH** knob to select menu number 01 on the display. Use **UP/DOWN** to select “**On**” on the display. Press the **CLR** key. This initializes the TS-450/690 to use an external antenna tuner, and disables the internal tuner. When tuning, be sure the **CAR** control is not rotated fully counterclockwise.

TS-570 Hints

When using the KT-100 with the TS-570 radio, be sure to connect the KT-100 to the **ANT 1** port on the TS-570.

TS-850 Hints

When using the KT-100 with the TS-850, switch **SW 1** on the rear of the transceiver must be set to **EXT**. This selects external tuner mode, and disables the internal antenna tuner.

The **THRU/AUTO** switch must be set to **AUTO**. Flip the **AT TUNE** switch to **ON** to begin a tuning cycle. Note that the **CAR** control must not be rotated fully counterclockwise, otherwise the tuning cycle will not work.

TS-870 Hints

When connecting the KT-100 to a TS-870, the KT-100 must be connected to the **ANT 1** jack on the rear of the TS-870. The **ANT 1** jack must also be selected before tuning. Press **THRU/AUTO** first, then press **AT TUNE** to begin a tuning cycle. **ON AIR** and **AT TUNE** LEDs will light during a tuning cycle on the TS-870. If tuning takes more than 20 seconds, either a triple beep or a Morse code “CHECK” alarm will sound. This is normal operation.

APPLICATION INFORMATION

Mobile Operation

The KT-100 is perfectly suited to mobile operation. It can be installed under the dashboard along with the transceiver, or mounted remotely. The only requirement is that the tuner remain dry.

The supplied radio interface cable is 14 inches long. If it is desired that the KT-100 is positioned farther from the transceiver than this cable length allows, a custom cable will need to be constructed. This can be accomplished in two ways: Cut the supplied cable and solder a jumper wire between all the connections, or purchase new connectors and cable to construct a custom-length interface cable from scratch.

The 6-pin AT-300 interface connector is Kenwood Part Number E09-0672-08, available from several Kenwood replacement part dealers. The 7-pin KT-100 interface connector is Kycon Connector Part Number KMDAX-7P, available from <http://www.mouser.com/> as Mouser part number 806-KMDAX-7P.

MARS/CAP Coverage

The KT-100 provides continuous tuning coverage over its specified range; not just in the ham bands. This makes it useful for MARS or CAP operation, or any other legal HF operation.

THEORY OF OPERATION

Some basic ideas about impedance

The theory underlying antennas and transmission lines is fairly complex, and in fact employs a mathematical notation called “complex numbers” that have “real” and “imaginary” parts. It is beyond the scope of this manual to present a tutorial on this subject³, but a little background will help in understanding what the KT-100 is doing, and how it does it.

In simple DC circuits, the wire resists current flow, converting some of it into heat. The relationship between voltage, current, and resistance is described by the elegant and well-known “Ohm’s Law”, named for Georg Simon Ohm of Germany, who first discovered the principle in 1826. In RF circuits, an analogous but more complicated relationship exists.

RF circuits also resist the flow of electricity. However, the presence of capacitive and inductive elements causes the voltage to lead or lag the current, respectively. In RF circuits, this resistance to

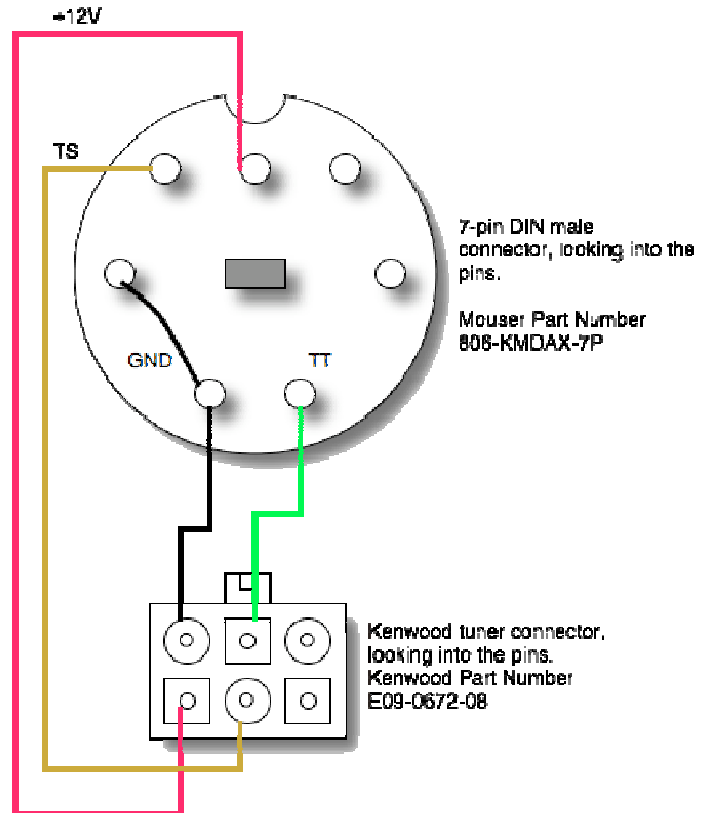

³ For a very complete treatment of this subject, see any edition of the *ARRL Handbook for Radio Communications* (previously the *Handbook For Radio Amateurs*).

the flow of electricity is called “impedance”, and can include all three elements: resistive, capacitive, and inductive.

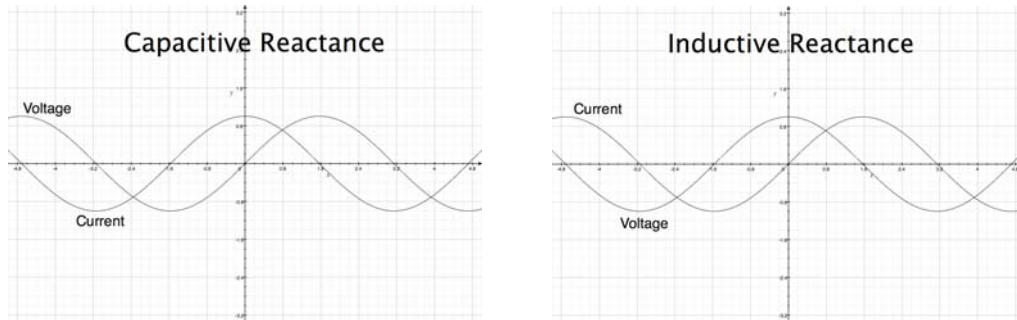

The output circuit of a transmitter consists of inductors and capacitors, usually in a series/parallel configuration called a “pi network”. The transmission line can be thought of as a long string of capacitors and inductors in series/parallel, and the antenna is a kind of resonant circuit. At any given RF frequency, each of these can exhibit resistance, and impedance in the form of capacitive or inductive “reactance”.

Transmitters, transmission lines, antennas, and impedance

The output circuit of a transmitter, the transmission line, and the antenna, all have a characteristic impedance. For reasons beyond the scope of this document, the standard impedance is nominally 50 ohms resistive, with zero capacitive and zero inductive components. When all three parts of the system have the same impedance, the system is said to be “matched”, and maximum transfer of power from the transmitter to the antenna occurs. While the transmitter output circuit and transmission line are of fixed, carefully designed impedance, the antenna presents 50-ohm, non-reactive load only at its natural resonant frequencies. At other frequencies, it will exhibit capacitive or inductive reactance, causing it to have an impedance other than 50 ohms.

When the impedance of the antenna is different from that of the transmitter and transmission line, a “mismatch” is said to exist. In this case, some of the RF energy from the transmitter is reflected from the antenna back down the transmission line and into the transmitter. If this reflected energy is strong enough, it can damage the transmitter’s output circuits.

The ratio of transmitted to reflected energy is called the “standing wave ratio”, or SWR. An SWR of 1 (sometimes written 1:1) indicates a perfect match. As more energy is reflected, the SWR increases to 2, 3, or higher. As a general rule, modern solid state transmitters must operate with an SWR of 2 or less. Tube excitors are somewhat more tolerant of high SWR. If a 50 ohm antenna is resonant at the operating frequency, it will show an SWR close to 1. However, this is usually not the case; operators often need to transmit at frequencies other than resonance, resulting in a reactive antenna and a higher SWR.

$$SWR = \frac{1 + \sqrt{R/F}}{1 - \sqrt{R/F}} \quad \text{where } F = \text{Forward power (watts), } R = \text{Reflected power (watts)}$$

SWR is measured using a device called an “SWR bridge”, inserted in the transmission line between the transmitter and the antenna. This circuit measures forward and reflected power from which SWR may be calculated (some meters calculate SWR for you). More advanced units can measure forward and reflected power simultaneously, and show these values and SWR at the same time.

1.00	1.00	1.00	1.00	1.00	1.00	1.00	1.00	1.00	1.00
1.05	1.10	1.15	1.20	1.25	1.30	1.35	1.40	1.45	1.50
1.20	1.25	1.30	1.35	1.40	1.45	1.50	1.55	1.60	1.65
1.35	1.40	1.45	1.50	1.55	1.60	1.65	1.70	1.75	1.80
1.50	1.55	1.60	1.65	1.70	1.75	1.80	1.85	1.90	1.95
1.65	1.70	1.75	1.80	1.85	1.90	1.95	2.00	2.05	2.10
1.80	1.85	1.90	1.95	2.00	2.05	2.10	2.15	2.20	2.25
1.95	2.00	2.05	2.10	2.15	2.20	2.25	2.30	2.35	2.40
2.10	2.15	2.20	2.25	2.30	2.35	2.40	2.45	2.50	2.55
2.25	2.30	2.35	2.40	2.45	2.50	2.55	2.60	2.65	2.70
2.40	2.45	2.50	2.55	2.60	2.65	2.70	2.75	2.80	2.85
2.55	2.60	2.65	2.70	2.75	2.80	2.85	2.90	2.95	3.00

An antenna tuner is a device used to cancel out the effects of antenna reactance. Tuners add capacitance to cancel out inductive reactance in the antenna, and vice versa. Simple tuners use variable capacitors and inductors; the operator adjusts them by hand while observing reflected power on the SWR meter until a minimum SWR is reached. The LDG Electronics KT-100 automates this process.

No tuner will fix a bad antenna. If the antenna is far from resonance, the inefficiencies inherent in such operation are inescapable; it's simple physics. Much of the transmitted power may be dissipated in the tuner as heat, never reaching the antenna at all. A tuner simply “fools” the transmitter into behaving as though the antenna were resonant, avoiding any damage that might otherwise be caused by high reflected power. For best performance, the antenna used should always be as close to resonance as is practical.

THE LDG KT-100

In 1995, LDG Electronics pioneered a new type of automatic antenna tuner. The LDG design uses banks of fixed capacitors and inductors, switched in and out of the circuit by relays under microprocessor control. An additional relay switches between high and low impedance ranges. A built-in SWR sensor provides feedback; the microprocessor searches the capacitor and inductor banks, seeking the lowest possible SWR. The tuner is a “Switched L” network, consisting of series inductors and parallel capacitors. LDG chose the L network for its minimum number of parts and its ability to tune unbalanced loads, such as coax-fed dipoles, verticals, Yagis, and, in fact, virtually any coax-fed antenna.

The series inductors are switched in and out of the circuit, and the parallel capacitors are switched to ground under microprocessor control. The high/low impedance relay switches the capacitor bank either to the transmitter side of the inductor bank, or to the antenna side. This allows the KT-100 to handle loads that are either greater than or less than 50 ohms. All relays are sized to carry 125 watts continuously.

50					31.05	31.00	0.75	6.05	5.00
60		10.00	6.54	4.01	1.05	3.75	3.31	3.06	3.85
70		15.04	9.05	5.51	1.44	3.03	3.10	3.14	3.98
80		25.06	0.33	6.15	1.05	4.10	3.75	3.33	3.80
90		75.00	31.34	6.05	5.31	4.14	3.80	3.73	3.85
100			32.03	5.05	5.03	4.50	4.16	3.53	3.48
110			35.04	0.00	6.10	5.10	4.14	3.05	3.40
120			34.03	10.10	5.00	5.10	4.85	4.10	3.80
130			35.05	10.00	5.05	6.05	5.00	4.14	4.00
140			75.00	14.60	0.00	6.10	5.14	4.54	4.34
150				15.04	0.00	5.10	5.03	5.00	4.44
160				33.06	14.34	5.05	6.10	5.31	4.60
170				34.30	10.00	0.75	6.54	5.75	4.84
180				15.00	15.00	0.75	5.35	6.00	5.00

The SWR sensor is a variation of the Bruene circuit. This SWR measuring technique is used in most dual-meter and direct-reading SWR meters. Slight

modifications were made to the circuit to provide voltages instead of currents for the analog-to-digital converters that provide signals proportional to the forward and reflected power levels. The single-lead primary through the center of the sensor transformer provides RF current sampling. Diodes rectify the sample and provide a DC voltage proportional to RF power. These two voltages are read by the ADCs in the microprocessor, and are used to compute SWR in real time.

The relays are powered by the 12VDC input provided by the radio interface cable. This power is supplied by the transceiver itself. The relays are a latching type, and so they consume no current when not actively switching.

Although the microprocessor's oscillator runs at 8 MHz, which allows the main tuning routine to execute in only a few milliseconds, the relays require several milliseconds of settling time for every combination of inductors and capacitors. Thus, it may take several seconds before all relay combinations are exhausted, in the case of a difficult tune.

The tuning routine uses an algorithm to minimize the number of tuner adjustments. The routine first de-energizes the high/low impedance relay if necessary, then individually steps through the inductors to find a coarse match. With the best inductor selected, the tuner then steps through the individual capacitors to find the best coarse match. If no match is found, the routine repeats the coarse tuning with the high/low impedance relay energized. The routine then fine tunes the inductors and capacitors. The program checks LC combinations to see if a 1.5:1 or lower SWR can be obtained, and stops when it finds a good match.

The microprocessor runs a fine tune routine just after the tuner finds a match of 1.5:1 or less. This fine tune routine now tries to the the SWR as low as possible (not just to 1.5); it takes about half a second to run.

A WORD ABOUT TUNING ETIQUETTE

Be sure to use a vacant frequency when tuning. With today's crowded ham bands, this is often difficult. However, causing interference to other hams should be avoided as much as possible. The KT-100's very short tuning cycle, as little as a fraction of a second, minimizes the impact of tuning transmissions.

CARE AND MAINTENANCE

The KT-100 tuner is essentially maintenance-free. Power limits in this manual should be strictly adhered to. The outer case may be cleaned as needed with a soft cloth slightly dampened with household cleaning solution. As with any modern electronic device, the KT-100 can be damaged by temperature extremes, water, impact, or static discharge. LDG strongly recommends the use of a good quality, properly installed lightning arrestor in the antenna lead.

TECHNICAL SUPPORT

The LDG Customer Support Center staff is ready to answer your product question by telephone and over the Internet. We know that you will enjoy your product even more knowing LDG is ready to answer your questions as the need arises.

Visit the Support Center at: <http://support.ldgelectronics.com>

Our website links you to the on-line Customer Support Center where you can send us a question, do your own research in the LDG Product Knowledge Books, and read through lists of frequently asked product questions. LDG regularly updates on-line information so the best on-line support information is available all day and every day.

The LDG website provides links to product manuals, just in case you lose this one! When you are thinking about the purchase of other LDG products our website also has complete product specifications and photographs you can use to help make your purchase decision. Don't forget the links to all of the quality LDG Dealers also ready to help you make that purchase decision.

TWO-YEAR TRANSFERRABLE WARRANTY

Your product is warranted against manufacturer defects in parts and labor for two full years from the date of purchase. This two-year warranty is also transferable. When you sell or give away your LDG product give the new owner a copy of the original sales receipt and the two-year warranty goes with the new owner.

There is no need to complete a warranty card or to register an LDG product. Your product receipt establishes eligibility for warranty service so save that receipt. Send your receipt with the product whenever you send your product to LDG for repair. Products sent to LDG without a receipt are considered requests for out-of-warranty repair.

LDG does not warranty against product damage or abuse. This means that a product failure, as determined by LDG, to be caused by the customer or by other natural calamity (e.g. lightning) is not covered under the two-year warranty. Damage can be caused by failure to heed the product's published limitations and specifications or by not following good Amateur practice.

OUT OF WARRANTY SERVICE

Any time a product fails after the warranty, LDG wants to help you get it fixed. Send the product to us for repair. We will determine what needs to be done, and, based on your prior instruction, either contact you with an estimate or fix it and contact you with a request to pay any repair charges. Please contact LDG if you have any questions before you send us an out-of-warranty product for repair.

RETURNING YOUR PRODUCT FOR SERVICE

Returning a product to LDG is easy. We do not require a return merchandise authorization. Visit the Customer Support Center and download the LDG Product Repair Form. On the Repair Form tell the LDG technicians exactly what happened or didn't happen and why you believe the product needs servicing. The technician attempts to duplicate the problem(s) you had based on how well you describe it so take the time to be accurate and complete.

Ask your shipper for a tracking number or a delivery verification receipt. This way you know the product arrived safely at LDG. Be sure to give us your email address so our shipper can alert you online when your product is en-route back to you. We regret that we are not staffed to provide periodic updates on the status of repairs. We can only indicate the repair is in process until it ships back to you. Please be assured that our staff makes every effort to complete repairs ahead of our published wait time. Your patience is appreciated.

Repairs can take six to eight weeks, but are usually faster than this. The most recent information on returning products for service is found at the LDG Customer Support Center.

Mail your carefully packaged repair with the Repair Form to:

LDG Electronics, Inc.
Attn: Repair Department
1445 Parran Rd
St. Leonard, MD 20685

PRODUCT FEEDBACK

We encourage product feedback! Tell us what you really think of your LDG product. In a card, letter, or email (preferred) tell us how you used the product and how well it worked in your application. Send along a photo or even a schematic or drawing to illustrate your narrative. We like to share your comments with our staff, our dealers, and even other customers at the LDG website.

<http://www.ldgelectronics.com/>

