

# SG-7200 SMARTMODEM MANUAL

SGC catalog number: 56-40

APRIL 1999

VERSION 2

USER MANUAL

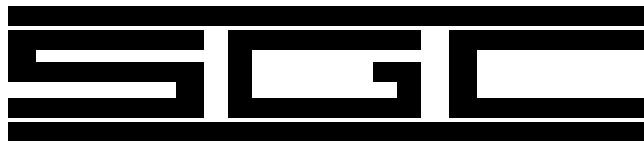

*“No Compromise Communications”*



# Table of Contents

System FEATURES .....	1
1.0 Supplied Items .....	2
2.0 Installation Procedure .....	2
2.1 Installation Procedure for SG-2000 .....	2
3.0 Introduction .....	3
4.0 SG-7200 SMARTMODEM Features .....	3
5.0 Digital Communication Modes .....	5
5.1 Communication Modes (Protocols) .....	6
5.1.1 Baudot/ASCII .....	6
5.1.2 Amtor .....	6
5.1.3 Pactor I .....	7
5.1.4 Maritime Mobile Marine CCIR 476/625 .....	7
6.0 Host Computer Operations .....	8
7.0 SG-7200 Setup for Amateur Radio Modes .....	8
7.1 Using the Command-Line Interface .....	8
7.2 Displaying the Current Setup .....	10
7.2.1 BAUDOT/ASCII Configuration .....	11
7.2.2 AMTOR Configuration .....	11
7.2.3 Commercial Maritime (SITOR) Configuration .....	11
8.0 Updating Software .....	12
8.1 Updating ROMDISK .....	12
9.0 Hardware Overview .....	14
9.1 i386EX Microprocessor .....	14
9.2 ADSP-2181 DSP .....	15
9.3 Zilog 85C30 SCC .....	15
10.0 Appendix .....	16
10.1 Amateur Mode (BAUDOT/ASCII/AMTOR/SITOR) Commands ..	16
10.2 Pactor Mode Commands .....	18
10.3 Commercial SITOR CCIR 476/625 Commands .....	19
FIRMWARE SECTION 2 .....	22
1.0 Program Setup .....	23
1.1 Program Requirements .....	23
1.2 Installation .....	23
1.3 Configuring the Software .....	23
1.3.1 Selecting the Operating Mode .....	23
1.3.2 Setting the Communication Parameters .....	23





1.4	Uninstalling the Software	.24
1.5	Starting the software	.24
2.0	Getting Started	.24
2.1	Accessing the Log Book	.24
2.2	Calling CQ	.24
2.3	Clearing the Transmit Buffer	.24
2.4	Dropping a Link	.24
2.5	Drop ARQ Link (Normal Disconnect)	.24
2.6	Sending a Simple Identification	.24
2.7	Linking to Another Station (ARQ)	.24
2.8	Receiving Graphic Files	.25
2.9	Accessing the Transceiver Control	.25
2.10	Accessing the File Status Window	.25
3.0	Program Toolbar	.25
4.0	File Handling	.27
4.1	Transmit File	.27
4.2	Transmit Filtered File	.27
4.3	Receive File	.27
4.4	File Queues	.27
4.5	File Transfer Status Window	.28
5.0	Program Macros	.28
5.1	Macro Types	.28
5.2	User Station Macros	.28
5.3	Other Station Macros	.29
5.4	Logging Macros	.29
5.5	Communications Macros	.29
5.6	Time and Date Macros	.30
5.7	Extended Time and Date Macros	.30
5.8	Miscellaneous Macros	.31
6.0	Special Keys	.31
6.1	Function Keys	.31
7.0	Printer Support	.32
7.1	Printing the Current Receive Buffer CTRL-P	.32
7.2	Toggling the Printer Onto a Port	.32
7.3	Printing the Copy Buffer	.32
8.0	Operating Modes	.32
8.1	ASCII / Baudot Operation	.33
8.1.1	Changing current operating speed	.33
8.1.2	Switching between Transmit and Receive	.33
8.1.3	Calling CQ	.33
8.1.4	Calling another Station	.33



8.2	AMTOR Operation	33
8.2.1	FEC Operations	33
8.2.2	ARQ Operations	34
8.2.2.1	Linking to Another Station	34
8.2.2.2	Killing a Link	34
8.2.2.3	Ending a QSO	34
8.3	PACTOR Operation	34
8.3.1	FEC Operations	34
8.3.2	ARQ Operations	35
8.3.2.1	Linking to Another Station	35
8.3.2.2	Killing a Link	35
8.3.2.3	Ending a QSO	35
8.4	SITOR Operation (SITOR Operating Mode only)	35
8.4.1	ARQ Listen Mode	35
8.4.2	FEC Listen / Standby Mode	35
8.4.2.1	FEC Operations	36
8.4.2.2	ARQ Operations	36
8.4.2.2.1	Linking to Another Station	36
8.4.2.2.2	Killing a Link	36
8.4.2.2.3	Ending a QSO	36
8.4.3	Free Channel Mode	37
9.0	Logging Operation	37
9.1	Entering a Callsign	37
9.2	Entering the other Operators Name	37
9.3	Entering the other Stations QTH	38
9.4	Entering the Operating Frequency	38
10.0	Setting Up Operating Parameters	38
10.1	CQ Repetitions	38
10.2	CQ Lines	38
10.3	CQ Delay	39
10.4	CQ Text	39
10.5	CQ Terminator	39
10.6	End Key Text	39
10.7	Identification Text ALT-I	39
10.8	End QSO Text	39
10.9	Logging/Text Parameters	40
11.0	Setup Menu	40
11.1	Communications Port	40
11.2	Transceiver Interface Setup	40
11.3	Directory / File Transfer Setup	40
11.4	Station Information	40
11.5	Set Time Zone	41



11.6	Brag Text	.41
11.7	Brag Files	.41
11.8	Setting the Screen Colors	.42
11.9	Callbook Options	.42
11.10	Wave File Setup	.42
12.0	TOR Modes	.43
12.1	AMTOR Listen	.43
12.2	AMTOR Standby	.43
12.3	SITOR	.43
13.0	Baudot Menu Option	.43
14.0	Misc Menu	.43
14.1	Logbook	.43
14.2	Search Logbook	.43
14.3	Command Mode	.43
14.4	Callbook Search	.44
15.0	TNC Menu	.44
15.1	Enter Command	.44
15.2	Switch Ports F4	.44
15.3	Set Port Gains F6	.44
15.3.1	Input Gain	.44
15.3.2	Output Attenuator	.44
15.4	Set TNC Parameters F7	.45
15.4.1	AAB WRU Text On	.45
15.4.2	RTTY Diddle On	.45
15.4.3	Reverse Receive Tone On	.45
15.4.4	Reverse Transmit Tone On	.45
15.4.5	Unshift On Space On	.45
15.4.6	AMTOR Control Delay	.45
15.4.7	AMTOR Tx Delay	.46
15.4.8	AAB Text	.46
16.0	View Menu	.46
16.1	Toolbar	.46
16.2	Status Bar	.46
16.3	TNC Status	.46
16.4	MiniLog	.46
17.0	Window Menu	.47
17.1	Cascade	.47
17.2	Tile	.47
17.3	Arrange Icons	.47
18.0	Help Menu	.47
18.1	Index	.47

18.2 Special Keys .....	47
18.3 About SGCCOM .....	47
HOST MODE SECTION 3 .....	48
1.0 Introduction .....	49
2.0 Entering Host Mode .....	49
3.0 Command Definitions .....	49
4.0 Command Program to TNC Structure .....	49
4.1 Requesting Command Information from the Controller .....	49
4.2 Sending Command Data to the Controller .....	49
4.3 Sending Transmit data to the Controller .....	50
5.0 TNC to Command Program Structure .....	50
5.1 Received Data .....	50
5.2 Echoed Data .....	51
5.3 Command Responses .....	51
5.4 Response to the "OP" Host Command .....	52
6.0 Command Set for AMATEUR RADIO MODE .....	54
7.0 Command Set for TOR Module CIRRR 476/625 .....	56



## System FEATURES

### **Open Hardware and Software Architecture**

- Designed for digital communications or as a freestanding general-purpose processor for embedded applications.
- Single Board Computer with DOS and Utilities
- BIOS and DOS Bootable from Flash Memory.
- 25 MHz Intel 386EX processor.
- Runs 16 or 32 bit applications.
- In-place 512K upgradable Flash Memory for storing resident applications.
- DRAM expandable to 16 M using standard 72-pin SIMMs.
- PC-104 socket allows for a range of expansion options.
- RS232 port for connection with host processor.
- 2 Radio ports with PTT, frequency control, and bi-directional serial support.

### **Programmable DSP Coprocessor**

- Analog Devices 2181 DSP - 80K bytes on-chip SRAM.
- 30 ns cycle time (33 MIPS).
- Analog Devices 1847 Stereo CODEC configured as two independent audio I/O channels.
- Inter-processor DMA path for program and data exchange.
- Easy DSP application development.

### **HDLC Hardware**

- Zilog 85C30.
- Configured as two independent channels between DSP and 386EX processor.
- Allows multiple port or cross-band connections.

### **Simple and Quick Software Development**

- Solid state Ramdrive in extended memory.
- Datalight REMDISK/REMSERV to access and execute host-based code.
- Runs Borland TDREMOTE.
- Runs DJGPP 32-bit public-domain code development software.
- DSP code development via RS232-based pod.
- Runs Analog Devices EZKIT DSP software tools.





## 1.0 Supplied Items

- DC Power cable with 2.1 mm connector one end
- Audio cable
- Serial extension cable RS-232 9 conductor M-F
- DIN 8 pin Plug with cable attached
- Procomm 2.0 for DOS shareware communications software
- GUI (Graphical User Interface) V1.66 for Windows Operating System

## 2.0 Installation Procedure

Connect RADIO 1 or RADIO 2 Port of the Modem to your radio using 8 Pin connector (cable supplied). Connect 9 pin straight through cable supplied to HOST COMPUTER connector and a PC comm port. For DOS mode use supplied Procomm software or another communication software package and set it to 9600 Baud 8 data bits 1 stop bit and no Parity. For Windows mode use GUI (Graphical User Interface) software supplied, see Control Program Users Guide section of this manual. No software or hardware protocol supported with this revision of firmware

### 2.1 Installation Procedure for SG-2000

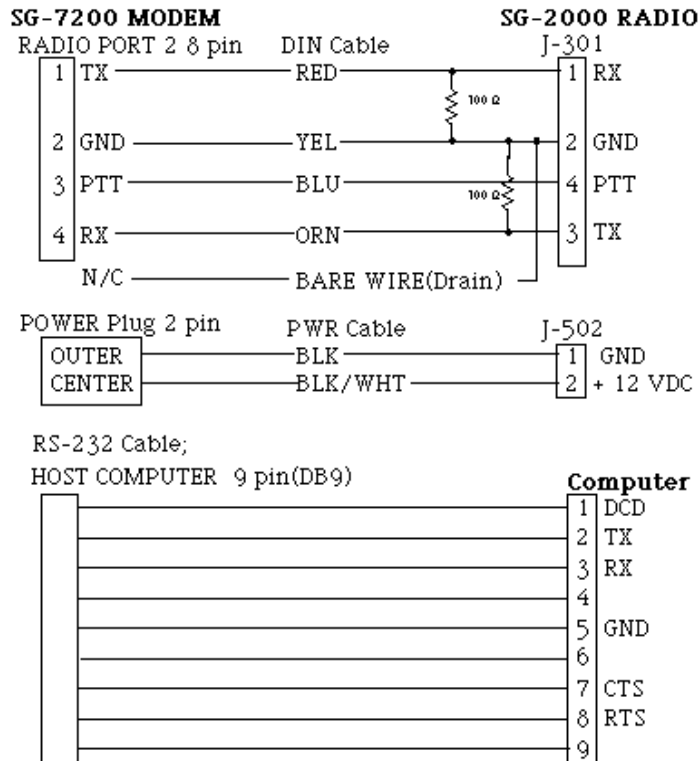





### 3.0 Introduction

Welcome to the world of advanced multimode DSP communications. The SG-7200 SMARTMODEM is designed for flexibility, performance, and affordability all of which are only possible with DSP technology. In addition, the user will recognize an environment that resembles an MS DOS-like system<sup>1</sup>.

The purpose of this manual is to describe the SG-7200 SMARTMODEM features, operations and configuration details. It is intended to get users on the air and start using the unit quickly. The structure of the manual is organized such that initial sections are to familiarize users with the hardware and software features, while later sections contain detailed information and summaries.

Appendices are provided that contain data for quick-reference.

### 4.0 SG-7200 SMARTMODEM Features

This section shows illustrations of the front and rear panels of the SG-7200 SMARTMODEM with brief descriptions of the identified features.

#### SmartModem Front Panel

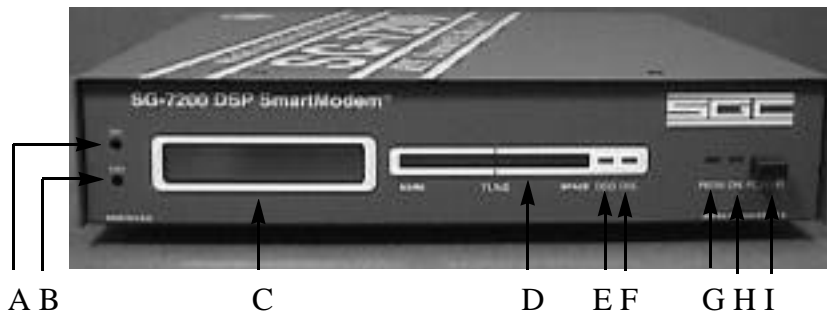

Illustration Legend	Name	Description
A	INT	Adjust Intensity of LCD display.
B	CON	Adjust Contrast of LCD display.
C	Display	LCD to display command and status. Display size is 2 lines by 14 characters.

<sup>1</sup> MS DOS is a trade mark of Microsoft Corporation.

**Note that the SG-7200 uses a MS DOS 6.22 clone developed by Datalight.**



Illustration Legend	Name	Description
D	LED Tuning Display MARK SPACE	Segmented display with 10 separated LED's segments used to display the tuning status of the station. Displays the mark tone (lower audio frequency.) Displays the space tone (higher audio frequency.)
E	DCD	Data Carrier Detect
F	OVL	Overload - indicates an overload condition at the audio input.
G	PRDN	Power down, or sleep state - for future use.
H	ON	Power indicator.
I	POWER	Power switch - powers unit on or off.

### SmartModem Rear Panel

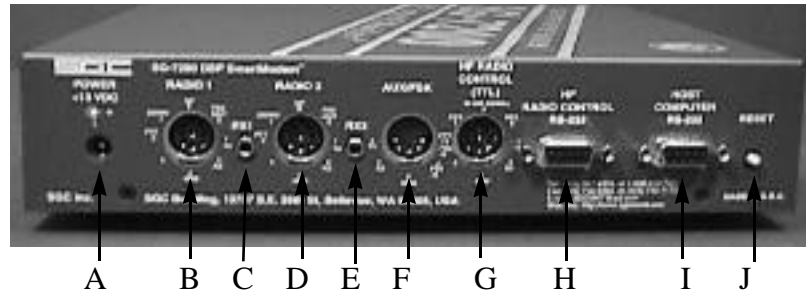

Illustration Legend	Connection Name	Connection Description	Pin Name	Pin Description
A	POWER JACK	(+13 VDC)		
B	RADIO 1	8-pin DIN for Radio #1	1 TX 2 GND 3 PTT 4 RX 5 6 FSK OUT 7 DOWN 8 UP	Transmit audio out Frame ground Push to talk Received audio out Currently unused Frequency shift keying Frequency control down Frequency control up
C	RX1	1/8" mini jack for audio monitor		



Illustration Legend	Connection Name	Connection Description	Pin Name	Pin Description
D	RADIO 2	8-pin DIN for Radio #2	1 TX 2 GND 3 PTT 4 RX 5 6 FSK OUT 7 DOWN 8 UP	Transmit audio out Frame ground Push to talk Received audio out Currently unused Frequency shift keying Frequency control down Frequency control up
E	RX2	1/8" mini jack for audio monitor		
F	AUX/FSK	5-pin DIN for auxiliary connection	1 FSK-N 2 GND 3 TX 4 FSK-R 5 RX	Freq. shift keying normal Frame ground Transmit audio out Freq. shift keying reversed Receive audio in
G	HF RADIO CONTROL (TTL levels)	8-pin DIN	1 TX 2 GND 3 PTT 4 RX 5 6 RTS 7 CTS 8 BI DIR SERIAL	Transmit audio out Frame ground Push to talk Receive audio in Not currently used Request to send Cleared to send Bi-directional serial
H	HF RADIO CONTROL RS-232	Either G or H may be selected. When H is selected, may be used with either RS232 Radio connection or a remote computer COM port.		
I	HOST COMPUTER RS-232	Connect to remote computer.		
J	RESET	Hardware reset		

### 5.0 Digital Communication Modes

Basically, the SG-7200 consists of an embedded DOS system with an integrated DSP coprocessor. Instead of the usual hard disk or floppy disks, the DOS system boots off a Flash ROM disk. Thus, familiarity with PCs and DOS is valuable when working with the SG-7200.

When the SG-7200 is first powered up, the usual PC boot-up-process happens; hardware tests (POST), followed by booting DOS and finally, the stored CONFIG.SYS and AUTOEXEC.BAT. These files are all stored on Flash ROM, which is organized much like a floppy disk drive, except that it is not as conve-



nient to update or write to this device - for updates, a special procedure must be followed .

The SG-7200 is provided with a main executable code module that provides communications support: NEWTOR.EXE. This code module is stored on the Flash ROM disk and is ready to be loaded into memory for execution. Once loaded, a code module remains active until terminated by the user. The code module is a regular DOS executable file.

SG-7200 software supports operation in several digital modes, or protocols. Some of these modes, such as Baudot, ASCII, AMTOR, and SITOR, are suitable for use by radio amateurs.

## **5.1 Communication Modes (Protocols)**

The SG-7200 supports a number of popular digital communication modes. Some are used extensively by radio amateurs while others are designed for use in the maritime mobile service.

### **5.1.1 Baudot/ASCII**

The commercial- or military-surplus Baudot-encoded teletypewriter (TTY) was the mainstay of amateur RTTY operators from 1946 through around 1977 when other digital modes become popular. FCC rules in Part 97, identify the Baudot code as the ITA 2 code, which is a 5-level code. This code has 32 different code combinations that requires the use of a “case shift” to implement a full operator’s keyboard.

The SG-7200 Baudot implementation, fortunately takes care of this rather confusing mode of operation by automatically doing the case shifting during receive and transmit. In addition, a “diddle” feature and “unshift on space” feature is provided to enhance RTTY operations. The user also may select the data rate for either 45,75 or 110 baud RTTY.

The ASCII mode is similar to the Baudot mode, except that an 8-level code is used that allows for the use of the full ASCII character set. Any data rate is technically possible. However, high data rates require special modems that occupy wider bandwidths. For this reason, only lower speed ASCII is presently available for ASCII operation.

### **5.1.2 Amtor**

Peter Martinez, G3PLX, popularized AMTOR, “Amateur Teleprinter over Radio” in the 1970’s. AMTOR is a derivative of a commercial maritime mobile communications mode SITOR . AMTOR was made part of the FCC regulations for amateur radio use in 1983.

AMTOR uses a scheme to improve communications of the 5-level



Teletype (TTY) systems by devising a 7-level code that, for valid characters, provides a constant ratio of four binary ones to three binary zeroes (4:3) in the code pattern. Such a code has the ability to determine whether received data is valid or not. This simple code then allows for a primitive means for data error control in either forward error control (FEC) or automatic repeat request (ARQ) modes.

When in FEC mode, each data character is coded in the appropriate 7-level code, then multiply sent at different times, so to enable time diversity detection. For ARQ, five characters are grouped together to form a 21-bit data packet which is sent in a strictly timed synchronized sequence.

The SG-7200 AMTOR implementation offers a modernized version of the original AMTOR implementation, adding several innovative features that have evolved since the introduction and acceptance of AMTOR.

### **5.1.3 Pactor I**

Pactor I is a recent development of German amateurs Hans-Peter Helfert, DL6MAA, and Ulrich Strate, DF4KV. It combines the most-desirable features of AMTOR and HF Packet radio. This protocol is superior to both these. Not only does it guarantee delivering error-free data, but also does it much more efficiently. The protocol is adaptive between 100 and 200 baud and does use of Huffman data compression to further improve efficiency. As for AMTOR, there are two basic modes FEC and ARQ.

### **5.1.4 Maritime Mobile Marine CCIR 476/625**

The SG-7200 firmware includes a dedicated CCIR 476/625 implementation that contains several features not used in Amateur Radio service. This implementation conforms fully with CCIR recommendations 476, 625, and 492. This includes ARQ, FEC, NAV-TEX, and SELFEC modes.

The SG-7200 can function in an automatic marine radio; traffic-handling environment by automatic reception, recognition and traffic forwarding according to "free channel" signal formats broadcasts. This comprehensive implementation allows the SG-7200 to operate equally well aboard vessels sailing the oceans, or part of shored-based operations.

SG-7200 CCIR 476/625 software uses a convention where the mark tone is the lower of the mark/space set. This requires that upper-sideband (USB) mode to be selected on a transceiver. When using this convention, the front panel LED display will correctly indicate mark and space signals. Transmission will also emit the



correct tone polarity. If for any reason, operation is needed for use on lower sideband (LSB) or alternate transmit or receive polarities Identification and SELCALs for ARQ or SELFEC can be any 4 digits, 4 letters, 5 digits, or 9 digits depending on the application. When the SG-7200 is used to participate in CCIR standard "free signal" broadcasting systems, an additional field follows the SELCAL that controls the operation of the free signal.

If the SELCAL is 4 letters, these form a CCIR476 call. If the SELCAL is 4 or 5 digits, a CCIR492 translation to CCIR476 is done. If the SELCAL is 9 digits, a CCIR625 translation is performed. If there is no "/" after the SELCAL, the call is made repeated for 60 sec. If there is a "/" followed by two letters after the SELCAL, the call will be preceded by a period in which the modem listens for the channel-free block formed by the two letters.

## **6.0 Host Computer Operations**

The SG-7200 could be operated either in command mode or alternatively by a GUI program running on a remote host computer.

- The GUI mode presents windows, menus, and popup boxes on the screen for ease of use with the computer mouse and keyboard. SGC offers Windows - based GUI software package designed for operation with the SG-7200.

This manual explains the command-line interface of the SG-7200. This is a very terse interface but is the simplest and most powerful method of communicating with the SG-7200. A dumb terminal or PC-based communications program such as Procomm, CrossTalk, Carbon Copy, or Windows' Hyperterm may be used to communicate with the SG-7200 through the SG-7200 Host Computer serial communications port.

## **7.0 SG-7200 Setup for Amateur Radio Modes**

This section describes how to set up and configure the SG-7200 hardware and also how to customize various operating parameters used for the digital communication modes.

### **7.1 Using the Command-Line Interface**

Setting up the SG-7200 through the command line interface is shown in the following steps:

- Decide which radio port you will use for the radio.
- Plug the radio cable into that port in the back of the SG-7200 SMART-MODEM unit.
- Connect your computer to the HOST COMPUTER RS-232 in the back of the unit and run the communication program.
- Turn the power on and a boot-up screen displays the following:

- Configure the unit according to the radio mode you plan to use.

```
A:\>REM *****SGC DATA MODEM Version 1.00 February 1997*****  
A:\>a:NEWTOR.exe  
***SG-7200 SMARTMODEM (C) SGC, INC 1997 [V1.2]***  
CMD:
```

Figure 1 Screen at Boot-up

This above display is the default and is controlled by the contents of the resident AUTOEXEC.BAT file in Flash ROM. The “CMD:” prompt indicates that the NEWTOR program is ready to accept commands. This program controls the Baudot, ASCII, SITOR and AMTOR modes. It is also possible to download other SG-7200 programs from a remote host via the serial port.

The following discussion further explores the NEWTOR program.





## 7.2 Displaying the Current Setup

Once the NEWTOR program displays its prompt, display the current setup using the “DIS” command an example of a setup is illustrated below.

```
Date/Time = Mon Sep 26 00:06:27 1988
Radio Port =1, Input Gain =4, Output Atten =0
MYSELCALL=SSGC SELCALL=SSGC
AMTOR PERIOD=536870912
SITOR PERIOD=447392427
Operating mode=0
TOR status 176
AMTOR mode
Answerback string ... (AAB)=QRA DE SGC
BAUDOT bit rate ..... (RBA)=45
ASCII bit rate ..... (RAS)=110
AMTOR Tx delay ..... (ADE)=30 ms
AMTOR Cd delay ..... (ACD)=5 ms
Display width ..... (ACR)=80 chars
Answerback status ... (AAS)=1
Auto Line Feed status (ALF)=1
Enable FEC ..... (RFE)=1
Receive Reversed ... (RXR)=0
Transmit Reversed ... (TXR)=0
Unshift On Space ... (USO)=0
RTTY diddle ..... (DID)=1
Filter output Mute .. (MAU)=0
Modem Subfunction ... (MSF)=0
```

This display shows radio port 1 is in use, audio input level is set for 6dB gain and output level is set for 0dB attenuation. Also shown, AMTOR mode is in effect, and the status and settings for a number of operational parameters. Some of these, for example, tx-delay controls basic behavior of the radio interface, while others like the MYCALL or the answer back fields, contain customized or personalized messages. There also are a number of control flags such as “diddle” and “unshift-on-space” that further customizes the user’s working environment.

The three-letter acronym printed next to these displayed fields is the appropriate command that may be used to change the field’s setting. The full command set is printed in the appendix.

Suggestions for a minimum configuration are described next.





### **7.2.1 BAUDOT/ASCII Configuration**

Baudot or ASCII modes of operation require very similar setup. For Baudot mode, enter “BAU” at the command prompt of the NEWTOR program. For ASCII, enter “ASC”. In addition, it is convenient to initialize the following settings as well.

- DAT/TIM - Sets Date and Time
- DID - Diddle on or off.
- TXT/RXR - Sets transmit and receive polarities.

### **7.2.2 AMTOR Configuration**

AMTOR operation is selected by entering AMT at the NEWTOR program’s prompt. AMTOR uses the high-tone pair (2125/2295 Hz); and uses 170 Hz shift FSK.

TOR modes require valid SELCAL and answerback strings prior to starting any ARQ calls. Other parameters such as the transmit and control delay may also need adjustment, however, the defaults should be workable for most modern radios.

Note that the SG-7200 immediately goes into standby mode when the AMT or SIT commands are issued at the command prompt. In this state the unit is ready to respond to any ARQ calls directed to it. It will also automatically print any FEC traffic (unless the FEC flag is disabled). The unit may be left in this mode indefinitely for monitoring calls or FEC traffic. Otherwise, the unit may be commanded to initiate an ARQ call or FEC broadcast, or to decode ARQ traffic in “listen” mode.

The following commands can be used to control the SG-7200 in this mode.

- MYSELCAL – AMTOR Selcal
- DAT / TIM - Date and Time
- AMT or SIT- AMTOR or SITOR mode
- ALI - Initiate Listen mode
- FEC - Initiate forward error correcting code
- ARQ - Initiate ARQ

In order to communicate data, keyboard mode must be entered using the “K” command. In this mode, characters entered at the keyboard will be submitted for transmission, and also decoded data from being received will be printed. Keyboard mode may be exited using the ESC key and re-entered as many times as needed.

### **7.2.3. TOR 625 Commercial Maritime Mobile (SITOR)**

This mode is entered by starting the TOR program. When in this mode, the SG-7200 is designed to operate in a Maritime Mobile traffic-handling environment. This mode differs from the TOR 476



program mode in that it conforms to special kinds of SELCALs. These callsigns are allocated to vessels by international law according to CCIR recommendations and may be composed of 4 letters, 4 digits, 5 digits, or 9 digits. The software automatically changes to either CCIR 476 or CCIR 625 modes to accommodate these different SELCALs. It also automatically detects and sets the correct mode when an ARQ call is established.

Slightly different configuration is needed depending on whether the SG-7200 is used aboard a vessel at sea, or used as part of a shore station. This involves the use of free-signal broadcasting and CW identification when used with shore-based operations.

Like for AMTOR mode, valid SELCALs and answer-back strings is required prior to initiating any ARQ calls. The keyboard mode also is used for this mode to enter data for transmission and to print received traffic.

## **8.0 Updating Software**

Experienced software developers may install their own software on ROMDISK. It is recommended that the SG-7200 Technical Reference Manual be consulted during such developments.

### **8.1 Updating ROMDISK**

Note all existing files in the Flash will be erased before the update begins.

A more permanent installation requires ROMDISK update. This requires that a full ROMDISK image be developed from the above process and be available for use in the steps outlined below.

Note: This ROMDISK image file must be on a hard disk not a floppy disk available for download in the following steps.

- It is assumed that a communications program is set for 9600, 8, N, 1 and is connected to Host Computer connector on the SG-7200. The communications program must be capable of transferring binary data using the XMODEM protocol such as ProComm or Telix.
- Power to the modem should be turned off. Enable the Flash update utility by setting JP5 (close to the front of the modem) to the "FORCE UPDATE" position 2-3 and turning the power on to the modem. This setting of JP5 will be detected by the bootstrap software and control passed to the Flash programming utility. Note that this utility uses DRAM as a memory cache to hold the new ROMDISK image and it is thus very important that the SIMM has been installed correctly. Also DRAM must be working and functioning perfectly before the Flash update was initiated, i.e. if the system succeeded in booting to the DOS prompt previously, that would be sufficient. As a precautionary step,

also check that JP3 is set in the “BOOT BLOCK PROTECT” position GND side.

- Shortly after reset, the Flash programming utility displays:

```
SGC Data Modem Flash Programming Utility V1.0
(c) Copyright 1996,1997 - Oregon Hardware-Software Factory
All rights reserved.
```

- This utility has several commands that can be displayed by entering a “?” symbol.

```
SGC-FL>?
Sx - Set memory segment
Ax - Set memory address
R - Read & display memory
N - Increment address, read & display
Wx - Write byte to memory
Dx - Dump page of memory at x
P - Update ROMDISK
! - Update BIOS ... read !!!WARNING - DANGER!!!
```

- To start the ROMDISK update, select the “P” option (capital P) after which the user is prompted with:

```
SGC_FL>P
Ready to update ROMDISK ? (Y/N)Y
```

- At this point the user should have the new ROMDISK image on hand, then enter “Y” (capital Y). After a short delay, the utility will report on its progress as Flash blocks and memory cache are being erased.

```
..... Erased Block #1
..... Erased Block #2
..... Erased Block #3
..... Erased Memory Cache
```

- Following the erase step, the user is then prompted to start the XMODEM download.

```
Start XMODEM download now ...CCCC
```

- Depending on the terminal program in use, activate the XMODEM download. The filename to be downloaded are then entered and the download procedure will continue for a few minutes. It is a good idea to verify the download byte count statistics to make sure that everything was transferred. Also check that the verification message from the programming utility succeeded:

```
Starting ROMDISK update .....
Verifying Flash against Memory Cache ..... OK
```





- Turn the modem power off. The FORCE UPDATE jumper, JP5 should now be moved back to the 1-2 position. Apply power and if all went well, the system should run through POST, boot DOS and perform the actions as required in the CONFIG.SYS and AUTOEXEC.BAT files.

## 9.0 Hardware Overview

The SGC SmartModem contains two programmable processing components; an i386EX microprocessor, and a ADSP-2181 DSP. In addition, a Zilog 85C30 SCC is available for processing high speed HDLC data between the control microprocessor and DSP. These advanced processing elements are tightly integrated into the data and interrupt control paths that exist between these components.

### 9.1 i386EX Microprocessor

The INTEL 386 EX Embedded Microprocessor User's manual describes the i386EX microprocessor. An overview of some microprocessor features as used in the SmartModem is given, however, full treatment of processor features are beyond the scope of this document.

This recently-introduced 80x86 family member is a fully static processor that is very similar to the 386SX in many respects. The 386EX, however, is Intel's latest entry in the 16/32-bit embedded processor market and contains a number of integrated peripherals that are typically needed in embedded applications requiring a high degree of PC compatibility. This allows existing PC software to be readily ported and new applications to be implemented on this platform.

Some of the 386EX on-chip integrated peripherals are of special interest; a chip-select unit (CSU), interrupt control unit (ICU), asynchronous serial I/O unit (SIO), and timer/counter unit (TCU). Other integrated peripherals like the direct memory access controller (DMA), refresh control unit (RCU), watchdog timer unit (WDT), and clock/power management, that are used either transparently by low-level system software, or made available for use at the PC-104 expansion slot.

To ensure PC compatibility, a Flash-resident system BIOS is provided. BIOS contains power-on, system-test (POST) code that checks out the processor, check and sizes memory prior to booting DOS. BIOS also provides support code at the BIOS interrupt function level which is essential maintaining compatibility with PC platforms. An in-place Flash update utility is provided to update the firmware.



## 9.2 ADSP-2181 DSP

The ADSP-2181 is a 24-bit instruction, 16-bit data, 33 million instructions per second (MIPS) DSP. The DSP is described in “Analog Devices ADSP-2181 DSP Microcomputer data sheet, Rev. A.”

Additional information is provided in the ADSP-2100 Family User’s Manual. 1993. Analog Devices, (Prentice-Hall, ISBN 0-13-006958-2.) The DSP is the heart of the real time signal processing engine - it works in conjunction with an AD1847 16-bit stereo CODEC that forms the interface to the analog world. The AD1847 is described in the “Analog Devices AD1847 Serial Port 16-bit SoundPort Stereo Codec. Data sheet Rev. 0.”

The CODEC contains two separate 16-bit A/D-D/A channels, each with their respective analog signal conditioning hardware. This allows two independent analog I/O signals to be processed simultaneously, for instance when serving a cross-band digital communications application. The CODEC hardware, however, requires that the operating modes of the channels are initialized to work identically.

## 9.3 Zilog 85C30 SCC

Although the DSP is capable of handling relatively high rate HDLC data streams in firmware, it is evident that the processing load associated with implementing two parallel DSP modems in addition to clock extraction, HDLC framing and inter-processor communications, this task best be taken care of by dedicated hardware specially designed for this task. The Zilog SCC is a suitable device that meets this description. The SCC can be programmed to be used for either asynchronous data communications processing for Baudot or ASCII modes at various bit rates, or for decoding HDLC streams at various bit rates. On-board hardware is provided to allow the SCC to use its internal DPLL to perform clock extraction.

Interfacing the SCC with the DSP is via four programmable flag (PF) pins. Two flags serve for input to the DSP that is utilized for output tone synthesis - the other two flags serve as serial data drivers that supply data to the SCC.

High speed HDLC data I/O between the SCC and the 386EX may be handled under interrupt control. The necessary drivers need to be installed and armed at the 386 side.



Some operating modes such as AMTOR/SITOR or PACTOR, does not make use of the SCC but implements its own bit extraction and protocol handling on the 386 side.

## 10.0 Appendix

From the CMD: prompt, type in the command from the following table. Only the first 3 characters is required, e.g., HEL for HELP. These commands are not case sensitive, which means you can type them as in upper or lower case letters.

### 10.1 Amateur Mode (BAUDOT/ASCII/AMTOR/SITOR) Commands

Command	Command Description	Parameters
AAB	Set WRU answerback	<string>
AAS	Set AAB	ON(=1)/OFF(=0) Default = 1
ACD	Set AMTOR control delay to <xx>	where xx = ms (milliseconds) Default = 5
ACH	Force AMTOR break-in	
ACL	Close AMTOR ARQ/FEC transmission	
ACR	Set display width to <xx> characters	where xx = display width up to 80 characters Default = 80
ADE	Set AMTOR tx delay to <xx>	where xx = ms (milliseconds) Default = 30
AL	Force mode L resync (AMTOR)	
ALF	Set Auto Line Feed	ON =1 OFF =0 Default = 1
ALI	Initiate AMTOR Listen mode (Mode L)	
AMT	Change operating mode to AMTOR, force STBY	
APE	Set AMTOR master timing to <xxxxxxxx> counts	Factory setting 536870912
ARQ	Initiate AMTOR ARQ to <xxxx>	Same as SELCAL <xxxx> Remote station SELCAL
ASC	Change operating mode to ASCII	
BAU	Change operating mode to BAUDOT.	
DAT	Set date	dd/mm/yyyy
DID	Change RTTY diddle feature	ON =1 OFF =0 Default = 1
DIS	Show all parameters	



Command	Command Description	Parameters
DSP	DSP commands	<1> = Rest, <11> = Select modem 1 <12> = Select modem 2
FEC	Initiate AMTOR FEC	
HEL	Help Command	
IGA	Set Input Gain	16 steps - from 1-15, each step is +1.5 decibel, max of 22.5. Default = 4 (6 db)
K	Start/continue converse mode	Keyboard mode. Shortcut keys: ESC=quit, ^U=ARQ Listen, ^T=ARQ Over, ^V=Force STBY (^ means pressing the CTRL key together with the next character).
L	Force LTRS (BAUDOT/AMTOR)	
MAU	Mute Filter output	0=pass 1=mute Default = 0
MYS	Set AMTOR MYSELCAL to <xxxx>	xxxx = sender's Selcal - 4 letters
OGA	Set Output Attenuation	16 levels - 0-15, with each level -1.5 db, max 22.5. Default = 0
POR	Set Radio Port	1 or 2 Default = 1
QUI	Quit SGC control program	
R	Force STANDBY, Clears transmit buffer (AMTOR/ASCII/BAUDOT)	
RAS	Set ASCII baud rate to <xxx>	where xxx = ASCII baud rate 45,75,110 Default = 110
RBA	Set BAUDOT baud rate to <xxx>	where xxx = BAUDOT baud rate 45,75,110 Default = 45
RCV	Go back to receive (ASCII/BAUDOT)	
RFE	Enable FEC reception	ON =1 OFF =0 Default = 1
RXR	Set receive reverse.	ON =1 OFF =0 Default = 0
SEL	Set remote SELCAL to <xxxx>	where xxxx = recipient Selcal, 4 letters
SIT	Change operating mode to SITOR, force STBY	
SPE	Set SITOR master timing to <xxxxxxxx> counts	Normally, factory setting. 447392427
STA	Get TOR status byte	
TIM	Set time	hh:mm:ss



Command	Command Description	Parameters
TIM	Set time	hh:mm:ss
TXR	Set transmit reverse	ON =1 OFF =0 Default = 0
USO	Set Unshift on space	ON =1 OFF =0 Default = 0
XMI	Go to transmit (ASCII/BAUDOT)	

## 10.2 Pactor Mode Commands

Command	Description
PAR	Start ARQ call. Station ID and remote's callsign need to be ready and cannot be changed on the fly. Set ID with PID and remote's call sign with PEL commands respectively.
PAU	Filter output mute. 0 = pass 1 = mute Default = 0
PBK	ARQ break-in. Issues a "break-in" command in ARQ call.
PBY	Force standby. Ready to respond to ARQ calls directed to this station. For response, PID must be used to set this station's callsign.
PDY	Enter Txdelay in milliseconds. 30 ms or so should be more than adequate. Recommended to leave the default value. Default = 30 ms
PEL	Enter remote station's callsign. Minimum of five characters, maximum of eight. Enter spaces to fill if needed.
PFE	Start Unproto transmission.
PFI	Flush low-level input buffer.
PFO	Flush low-level output buffer.
PID	Enter Our Identity. Minimum of five characters, maximum of eight. Enter spaces to fill if needed.
PIG	Enter input gain in +1.5dB steps. Default 4*1.5 = 6dB.
PKE	Keyboard mode. Shortcut keys: ESC=quit, ^U=Start ARQ, ^T=ARQ Over, ^V=Force STBY, ^R=ARQ close down (^ means pressing the CTRL key together with the next character).
PLI	ARQ/Unproto listen mode. The user should enter keyboard mode (PKE) to display traffic.
POG	Enter output attenuation in +1.5dB steps. Default 0*1.5 = 0 dB
POL	Sets an end-of-link request (ARQ only).
POV	ARQ link "OVER".
PPO	Enter radio port number (1 or 2). Default = 1
PRS	Reboot DSP and reload Pactor modem.
PTS	Test. Enters a test mode where alternating mark and space are sent at 100 baud. Terminate by hitting any character.
PUN	Set Unproto Speed (100/200) baud. Default is 100.
PUR	Set Unproto repeat count to 1, 2, or 3 times. Default is 2.
Q	shuts down and exits the 625 mode in an orderly fashion





Command	Description
TAF	Test AFSK. Each time TAF is entered, the next state in the mark-space-mute cycle is activated.
TAT	Test/display Pactor status.
TIN	Test interrupt system. The Pactor modem interrupts the control processor at 1 millisecond intervals – this command counts 1000 interrupts and thus prints a message each second. Used for engineering purposes.
TPF	Prints out flags and other operational parameters: Our ID Remote ID Unproto rate Unproto repetitions Tx Delay RadioPort InputGain OutputAttenuation ppmCorrection
TT+	increases the timing correction parameter by the equivalent of 1 ppm.
TT-	reduces the timing correction parameter by the equivalent of 1 ppm.

### 10.3 Commercial SITOR CCIR 476/625 Commands

Command	Description
HELP	List all the command-mode commands
Q	shuts down and exits the 625 mode in an orderly fashion
SAB	sets the answer back string. This may be empty if the answerback needs to be disabled.
SAR	initiates an ARQ call. Station ID and SELCAL need to be set up previously and cannot be changed on the fly. Set ID with SID, SELCAL with SEL commands respectively. TNC returns to "dead" when link terminates normally, or when there is a failure at ARQ phasing, channel free check, or rephasing attempt fails. ARQ calling will be using CCIR625 protocol when the previous SEL command set a 9-digit call.
SBY	enters standby mode where TNC waits for FEC, SELFEC, or ARQ calls.
SCW	sets the CW-id. May be empty if the CW-id is disabled.
SDI	sets the allowable signal distortion level. Progressive levels above zero (up to 5) will tighten the margin on when the limits of acceptable distortion will be reached and RQ's will be issued.
SDY	Tx delay (# x 8.3 ms) Default = 2 (16.6 ms)



Command	Description
SEC	sets the "lcfg" to allows or not disable locally-generated echo. Default = 1
SID	sets the TNC's identification. The ID may be 4 letters, 4 or 5 digits that would make the unit respond in CCIR476 mode. If the ID is 9 digits it will respond in CCIR625 mode. May be set twice, once with a CCIR476 and then with a CCIR625 identification. The TNC will then respond to either call. An optional "/" may follow the ID with two letters followed by an optional two digits. When the "/" and digits are present a channel-free signal will be sent formed by these letters. If the letters are followed by the digits, these digits form the time interval (digits x 450ms) that the modem will remain in standby before returning to "dead". If no digits are given, this delay is 15 sec. If no "/" and letters given the TNC never times out of standby. If the CW id is set (SCW) and free channel transmission is enabled, a free signal broadcast will consist of the CW-id followed by eight channel free blocks. CW-id is omitted when CW-id is null. If a dual ID is set, only the channel-free data from the last call will be used. Like for SELCAL, do not change ID on the fly.
SLI	initiates ARQ listen mode. The user should enter keyboard mode to print traffic. Returns to "dead" when SOL or SOT issued.
SIG	Enter input gain in +1.5dB steps. Default 4*1.5 = 6dB.
SOA	Enter output attenuation in +1.5dB steps. Default 0*1.5 = 0 dB
SOL	sets an end-of-link request. This is recognized in ARQ send (SAR), FEC send (SFE), ARQ listen (SLI), and Test mode (STS). In these cases, the operation is terminated and the TNC returns to "dead" mode awaiting new commands. Note; if ARQ is attempted and it has not yet linked, this command will not affect the termination of the present mode. Use SED is this case.
SOT	sets an end-of-transmission. This causes an ARQ link to finish sending any pending traffic en then change to the link receive by sending the +? group. Note that this command does not merely stuff data into a buffer, but actually checks and verifies that the link actually changed over. If needed, it will repeat sending +?. In FEC, this command finishes sending all pending traffic and behaves like SOL.
SOV	sets the "ovrflg" that allows the IRS to respond or not to +?
SPO	Set Radio Port 1 or 2. Default = 1
SRE	sets the "repflg" to allow or disable relinking after timeout. Default = 1
SRP	determines whether or not the receive polarity needs to be normal or inverted. SRP 0, is for normal polarity, SRP 1 is for inverted polarity. Default = 0

Command	Description
SPS	DSP Reset
STP	determines whether or not the transmit polarity needs to be normal or inverted. STP 0, is for normal polarity, STP 1 is for inverted polarity. Default = 0
STS	enters a test mode where alternating mark and space are sent. Exit from test with DED, SOL, or SOT commands.
TAF	tests AFSK by cycling through the various AFSK tones. A new tone is emitted each time the command is executed.
TAT	reads and displays the 625 status word.
TCS	displays the status of the low-level 625 output buffer.
TIM	checks whether the DSP is generating interrupts.
TPF	reads and displays the current status of 625 flags and other operational parameters.
TT-	reduces the timing correction parameter by the equivalent of 1 ppm.
TT+	bumps the timing correction parameter by the equivalent of 1 ppm.





# **SG-7200 DSP SmartModem Control Program Users Guide**

Version 1.66

FIRMWARE SECTION 2

## 1.0 Program Setup

The following are the steps required to install the SG-7200 control program. This program requires either Window 3.1 or Windows 95.

### 1.1 Program Requirements

This program requires a 386/16mhz or faster CPU, 8 Meg of memory and Windows 3.1 or Windows 95 (preferred). At least 2meg of available hard disk space is required for program installation.

### 1.2 Installation

The following steps should be followed for program installation.

1. Place distribution disk into the floppy drive.
2. Using the Run Option in the Files Menu (Win3.1) or the Start Button (Win95), select the floppy drive and execute the SGCXXX.EXE (XXX Version number) file on the disk. This will start the installation process.
3. Follow the on screen prompts to complete the program installation.

### 1.3 Configuring the Software

During the configuration process the user will have to make several selections. Be careful when making these setting to ensure proper program operation.

#### 1.3.1 Selecting the Operating Mode

The program has two different operating modes. These are Amateur operation and SITOR Operation. Amateur operation gives the user the ability to select between AMTOR, ASCII, BAUDOT and PACTOR operation. The SITOR option is designed for Ship to Shore operation.

#### 1.3.2 Setting the Communication Parameters

Use the following settings when configuring the program

- 9600 baud (this is the only value that is currently supported by the 7200.
- COM Port. The com port of the computer that the SG7200 is connected. Be careful to select the proper port. The program supports ports 1 to 8.
- 8 data bits
- 1 stop bit
- No Parity





## **1.4 Uninstalling the Software**

If necessary to un-install the software, use the Uninstall prompt in the SG-7200 program group. This will remove all program files from the system.

## **1.5 Starting the software**

To start the software turn on the modem and wait for it to initialize then select the SG-7200 DSP SmartModem entry in the SGC program group.

## **2.0 Getting Started**

Below are outlined the most common first time questions from users. This should give the user a quick start on the basic program options and keystrokes.

### **2.1 Accessing the Log Book**

Press F3 to toggle the Logging window for the current port.

### **2.2 Calling CQ**

In most modes calling CQ is the normal method of establishing a QSO with another station. To call CQ, press F5 or click on the CQ button on the Tool Bar.

To stop the CQ, press the F5 a second time. The CQ will be aborted after the current text clears the transmit buffer.

### **2.3 Clearing the Transmit Buffer**

To clear the transmit buffer, press the DELETE key.

### **2.4 Dropping a Link**

Forced Drop (ARQ Modes)

To force drop a link or link attempt, press the HOME key.

### **2.5 Drop ARQ Link (Normal Disconnect)**

To drop or disconnect the current link, press either ALT-D or SHIFT-ALT-D or use the QRT button on the toolbar.

### **2.6 Sending a Simple Identification**

Press ALT-I to send the user defined identification text for the current mode.

### **2.7 Linking to Another Station (ARQ)**

To link to another station Press ALT-C, enter the Selcal or Callsign for PACTOR Mode of the other station and press Enter. This will start the link.



## 2.8 Receiving Graphic Files

This program supports graphic files in BMP, JPG, PNG or PCX format in PACTOR Mode. It is required for the user to have an external graphics viewing program like LView, Paintshop Pro or other graphics editor that accept command line arguments.

For digital use, JPEG format pictures saved with a JPEG quality of 50 to 70 work well. Note that using a higher quality level results in a considerable larger file, which may be difficult to transmit.

To setup the graphics viewer, use the following steps.

1. Go to Setup Menu.
2. Go to Operating Parameters
3. Select the "Graphics" tab
4. Click on "Select Viewer"
5. Using the File Selector, find the file of the viewer that you wish to use and select ok.

The program will now call your viewer whenever a recognized graphic format is received during a binary file transfer. You may also use the View Graphic option in the file menu to view a file through the external viewer.

## 2.9 Accessing the Transceiver Control

To access the transceiver control panel, press F9. This is used to toggle the control panel on and off of the screen.

## 2.10 Accessing the File Status Window

The file status window is used to display the current status of the files that are being sent. Use F8 to access this screen. F8 will also deactivate the window.

## 3.0 Program Toolbar

The toolbar allows quick and simple access to the most frequently used program controls. This section gives a quick overview of the toolbar controls.



Transmit file. See Transmit File in the File Handling Section.



File Queue. See File Queues in the File Handling section.

















Transmit Filtered File. See Transmit Filtered File in File Handling section.



Open Receive File. See Receive File in File Handling Section



-  Auto CQ. This tool controls the Automatic CQ feature for the program. This button acts like a toggle. The first click enables the CQ feature; the second click disables the CQ feature. This control has the same functionality as the F5 key.
-  QRT (End QSO). This tool is used to end the current link. It has the same functionality as pressing the END key.
-  ID Control. This tool is used to send the identification text that is defined for the current operating mode. See Operating Parameter section for more information on defining this text. This tool has the same functionality as pressing ALT-I.
-  Transmit Control. Pressing this tool will place the SmartModem into Transmit Mode. This has the same functionality as pressing the Page Up key.
-  Clear Transmit Buffer. Pressing this control will clear the current TNC transmit buffer. This has the same effect as pressing the DELETE key.
-  Receive Control. Pressing this control will place the TNC into receive mode if the current mode is ASCII or Baudot. If the mode is AMTOR it will issue a changeover request to the transmitting station. This control has the same effect as pressing the Page Down key.
-  Clear Receive Buffer. Pressing this control will clear the contents of the receive window and buffer.
-  Set Transmit Polarity. This control sets the current transmit polarity. If the control is “right” reading the transmit invert option is turned off. If the control is displayed “upside-down” the transmit invert option is set to on.
-  Set Receive Polarity. This control sets the current receive polarity. If the control is “right” reading the receive invert option is turned off. If the control is displayed “upside-down” the receive invert option is set to on.
-  Increase Transmit Speed. This control will increase the transmit speed in ASCII and Baudot modes. This control has no effect in AMTOR.
-  Decrease Transmit Speed. This control will decrease the transmit speed in ASCII and Baudot modes. This control has no effect in AMTOR.
-  Letters/Figures State. This control sets the Letters/Figures state for the TNC. This is active in AMTOR, ASCII and Baudot.
-  Cut. This key cuts the current highlighted section.
-  Copy. Copies the current highlighted section to the clipboard.





Paste. Copies the contents of the clipboard to the transmit buffer. This allows the user to copy data from one window or application and immediately send it to the TNC.



Print. Prints the complete contents of the receive buffer to the printer.



About. This control displays the program about box as well as additional information regarding memory and GUI usage.

## 4.0 File Handling

### 4.1 Transmit File

Using the Transmit File option allows the user to select a file to send to another station. This file will be placed at the end of the current file queue for this port.

The program will not filter or remove any character from file and it will be sent in its original format.

### 4.2 Transmit Filtered File

This tool bar or menu option allows the user to send a file that will be interpreted through the macro handler. This will enable the user to embed macros into a file to "personalize" the outgoing text. Refer to the Macros section on available insertion and typeover macros.

### 4.3 Receive File

To receive a text file follow the steps listed below.

1. Click on the Tool bar Icon or select Receive File from the Files Menu.
2. Enter File Name for new file in File Dialog. The second option is to select an existing file and the data will be appended to this file. At the point a 'R' should appear in the Status Bar of the current port, stream or TNC.
3. To stop receiving the file to disk, click on the Tool bar Icon.

### 4.4 File Queues

The file queue allows the user to review the current status of files that are waiting to be sent for the current port or channel. Each port or channel has its own file queue.

To delete a file(s) from the queue, select the file to be deleted with the mouse and then click on delete. Multiple files may be selected.

The extensions are the file name indicating how the file will be sent.

Files are listed in the order they will be sent to the other station.

Their extensions are as follows:

NONE-No extension, will be sent as normal text. No translations made.





FILTERED-Program macros will be inserted or typed over.

#### 4.5 File Transfer Status Window

This window shows the current status of any file transfers. This can be brought up onto the screen at any time by pressing F8, to remove this window, press F8 a second time.

The two lines indicate transmit file status information. The first field of the status window displays the filename followed by the file size, and transfer statistics for the file.

### 5.0 Program Macros

The following macros may be placed in any file or user defined brag text or operating parameters. These macros allow the user to have full control over time, data, callsign and other exchange information that might be of interest during normal operation.

#### 5.1 Macro Types

There are two forms of macros that may be used. These forms are insertion and typeover. In the case of the insertion macro the text will be inserted into the outgoing text stream. For example of the name macro (sn) is used in insertion mode it will be used as shown.

Macro Line    Hello this is ~sn how are you today.  
Outgoing Text Hello this is John how are you today

This assumes that the user name of John has been defined in the User Information of the program.

Typeover macros are designed to preserve the line length. In this case any text that is placed directly behind the macro may be overwritten if the macro text is longer than the space of the macro. This must be taken into consideration when designing graphics for file transfer.

The insertion mode uses the tilde character (~) to start the macro. The typeover mode uses the "at" (@) symbol to start the macro.

#### 5.2 User Station Macros

The following macros are available to allow you to embed information about your station into outgoing text.

sn	-	Your first name
sc	-	Your callsign
sq	-	Your QTH (station location)
ss	-	Your AMTOR SELCAL



These macros are supported in both Insertion and Typeover versions.

Start Insertion Macros with '~'.      Example      ~sn  
Start Typeover Macros with '@'.      Example      @sn

Example (insertion style): Hi, this is ~sn in ~sq  
Would be sent as: Hi, this is John in Somewhere, Ca

### 5.3 Other Station Macros

The following macros are available to allow you to embed information about the other station into outgoing text.

hn	-	His first name
hc	-	His callsign
hq	-	His QTH (station location)
hs	-	His AMTOR SELCAL

These macros are supported in both Insertion and Typeover versions.

Start Insertion Macros with '~'.      Example      ~hn  
Start Typeover Macros with '@'.      Example      @hn

Example (insertion style): Hi ~hn, how are things in ~hq today.  
Would be sent as: Hi John, how are things in Bakersfield, CA today.

### 5.4 Logging Macros

The following macros are available to allow you to embed information about the other station into outgoing text.

ld	-	Date of Last QSO
lf	-	Frequency of Last QSO
lm	-	Mode of Last QSO
lt	-	Time of Last QSO
qs	-	Number of total log entries

These macros are supported in both Insertion and Typeover versions.

Start Insertion Macros with '~'.      Example      ~lt  
Start Typeover Macros with '@'.      Example-      @lt

Example (insertion style): Out last qso was on ~ld at ~lt using ~lm..  
Would be sent as: Our last qso was on 95/01/01 at 01:00 using PACTOR.

### 5.5 Communications Macros

These macros allow control, transmit or receive flow from within Brag Files and Brag Text



- ~OE - End current ARQ link or QSO after all data is sent.  
Send no additional data to TNC.
- ~OR - Sets TNC to Receive Mode after all data has been sent  
Send no additional data to TNC.
- ~OT - Sets TNC to Transmit Mode

## 5.6 Time and Date Macros

The time and date macros are used to insert the current time and date in various formats. Both local and universal times are supported through the macros. These macros are supported in both insertion and typeover modes. Insertion mode is shown in the text

- ~tu Prints the current UTC time.
- ~tl Prints the current local time.
- ~du Prints the current UTC date.
- ~dl Prints the current Local date.

## 5.7 Extended Time and Date Macros

The extended time and date macros can be used by the user to get even more control over the formatting of times and dates. These macros will work in either insertion or typeover mode.

You may also select either Local or UTC time by changing the first character in the macro.

For UTC use an upper case 'X' or Local time use a lower case 'x'. All macros below are shown using UTC format using the insertion (~) prefix..

- ~Xa Abbreviated weekday name
- ~XA Full weekday name
- ~Xb Abbreviated month name
- ~XB Full month name
- ~Xc Date and time
- ~Xd Two-digit day of month (01 - 31)
- ~XH Two-digit hour (00 - 23)
- ~XI Two-digit hour (01 - 12)
- ~Xj Three-digit day of year (001 - 366)
- ~Xm Two-digit month as a decimal number (1 - 12)
- ~XM 2-digit minute (00 - 59)
- ~Xp AM or PM
- ~XS Two-digit second (00 - 59)
- ~XU Two-digit week number where Sunday is the first day of the week (00 - 53)
- ~Xw Weekday where 0 is Sunday (0 - 6)
- ~XW Two-digit week number where Monday is the first day of week

- the week (00 - 53)
- ~Xx Date
- ~XX Time
- ~Xy Two-digit year without century (00 to 99)
- ~XY Year with century
- ~XZ Time zone name, or no characters if no time zone

## 5.8 Miscellaneous Macros

These macros give the user additional program and controller operation. All macros are available in insertion and typeover modes unless otherwise specified.

- ~r Appends a carriage return at the current position in the line. This macro is only available in insertion mode.
- ~f Prints the current frequency from the logbook. If a transceiver interface is being used the data will be retrieved automatically from the interface.
- ~m Prints the current operating mode.
- ~qs Prints the current log entry number. This is based on the file size and can not be modified by the user.
- ~~ This is the escape sequence. If you need to imbed the macro insertion character '~' into the text stream. Add it as ~~ to the file.

## 6.0 Special Keys

This section of help describes the special function keys that are available when using the program with the SG-7200 controller. You can access the special key screens from within the program at any time by pressing ALT-Z.

### 6.1 Function Keys

- F1 Access On-Line Help
- F2 Enter Callsign/Selcal of the other station.
- F3 Display the built in logbook in the program.
- F4 Switch TNC from Port 1 to Port 2 or vice versa
- F5 Call CQ in the current mode of operation.
- F6 Display Port Gain Setting Dialog Box
- F7 Display TNC Parameters Dialog Box.
- F8 Display File Transfer Status Window
- F9 Display Transceiver Control Panel (this option is only available if an external Transceiver control has been selected during program setup).
- F10 Not Used
- F11 Enter TNC command. Allows the user to manually enter a TNC command

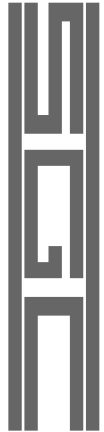



F12 Switch to the next window. This is used when multiple windows are currently being displayed.

#### CTRL F1 to F10

The CTRL F1 through F10 keys allow the user to transmit a user defined file. These files may be setup in the Setup Menu.

## 7.0 Printer Support

This program offers three methods of printing data. All of these methods use the Windows print spooling to help the program integrate with other Windows applications.

### 7.1 Printing the Current Receive Buffer CTRL-P

Printing the contents of the receive buffer uses the Print option from the Files menu or the CTRL-P keystroke. Issuing this command will cause the program to request the printer information and the user may select either OK or CANCEL to the print request.

This option printer the entire receive buffer. The user can preview the printing by using the Print Preview option from the Files menu.

### 7.2 Toggling the Printer Onto a Port

This program has the ability to print data as it is received from the TNC. This is done in the following way. The program holds data in a buffer until one of two conditions occurs. The first condition is that the buffer holds a full page of data, at this point the program will queue up the page and send it to the print spooler within windows. The second condition is when the user Toggles the Printer OFF. When this occurs, the program will print any remaining data to the printer.

This allows the user to print several incoming ports or stream of data while keeping the data totally separate between ports.

### 7.3 Printing the Copy Buffer

If you highlight text in the receive buffer you can print the data directly by choosing the Print Option from the popup menu that appears after the left mouse button is released.

## 8.0 Operating Modes

When terminating the GUI program, the mode last used and settings will be invoked upon re-entry into the GUI.

Note: Any time the GUI is started the modem should be in the initialized power up state.



## 8.1 ASCII / Baudot Operation

Baudot operation (also known as RTTY) is a favorite of DXers. This is a non-linked mode of operation and is highly affected by band conditions. It is recommended to use the tightest possible bandwidth filtering on the radio for best results. ASCII is not too often used on the ham bands but does offer a few interesting features, namely it can transmit characters between 0 and 255.

### 8.1.1 Changing current operating speed

Click on the '+' or '-' signs in the toolbar. The new speed will be displayed in the status bar for the current port.

### 8.1.2 Switching between Transmit and Receive

To switch to transmit mode, press the Page Up key.

To switch to receive mode, press the Page Down key.

The end key may also be used and will provide any additional text that was defined in the operating parameters of the program.

### 8.1.3 Calling CQ

To call CQ in Baudot or ASCII, press the F5 key. This will send out the text as defined in the Baudot operating parameters under the setup menu.

If another station links to you, be sure to press F5 to cancel the CQ.

### 8.1.4 Calling another Station

To call another station in Baudot or ASCII use the following steps.

1. Press F2 and enter the Callsign of the other station.
2. Press ALT-C and press enter when ready.

The program will send a call to the other station using the text that is defined in the Baudot or ASCII operating parameters.

## 8.2 AMTOR Operation

### 8.2.1 FEC Operations

FEC operations are "one-way" forms of communication. This can be convenient for "round table" operations involving more than one other station. There are only three active controls required for FEC operation. There are Page Up which places the TNC into transmit mode, Page Down which places the TNC into receive mode after the appropriate idle sequence and the End Key which provides a formatted changeover to receive mode.

To operate in FEC mode, first place the TNC into the appropriate



mode using the Menu, right mouse click or special key option. Then press Page up to go into the transmit mode. When ready to receive press Page Down.

You may PANIC Kill the transmitter at any time by pressing the HOME key.

### **8.2.2 ARQ Operations**

ARQ operations are characterized as two stations in a "linked" QSO. The advantage of ARQ operation is that it is virtually error free. When a station does not receive a data frame correctly it will "REQUEST" a repeat of the data frame.

#### **8.2.2.1 Linking to Another Station**

To link to another station, use the following steps.

1. Enter the Selcal of the other station.  
This can be done using the F2 Enter Call dialog box, or highlighting the call with the mouse.
2. Press ALT-C and press enter when ready.  
If the link is successful and Announcements have been selected, the Selcal will be played via CW or Voice.

#### **8.2.2.2 Killing a Link**

To force kill a link,. press the HOME key. This will drop the link immediately.

#### **8.2.2.3 Ending a QSO**

Press either ALT-D (this sends the END QSO text) or ALT-SHIFT-D (sends no additional text).

## **8.3 PACTOR Operation**

### **8.3.1 FEC Operations**

FEC operation are "one-way" forms of communications. This can be convenient for "round table" operations involving more than one other stations. There are only three active controls required for FEC operation. There are Page Up which places the TNC into transmit mode, Page Down which places the TNC into receive mode after the appropriate idle sequence and the End Key which provides a formatted changeover to receive mode.

To operate in FEC mode, first place the TNC into the appropriate mode using the Menu, right mouse click or special key option. Then press Page up to go into the transmit mode. When ready to receive press Page Down.



You may PANIC Kill the transmitter at any time by pressing the HOME key.

### **8.3.2 ARQ Operations**

ARQ operations are characterized as two stations in a "linked" QSO. The advantage of ARQ operation is that it is virtually error free. When a station does not receive a data frame correctly it will "REQUEST" a repeat of the data frame.

#### **8.3.2.1 Linking to Another Station**

To link to another station, use the following steps.

1. Enter the Callsign of the other station.

This can be done using the F2 Enter Call dialog box, or highlighting the call with the mouse.

2. Press ALT-C and press enter when ready.

If the link is successful and Announcements have been selected, the callsign will be played VIA CW or Voice.

#### **8.3.2.2 Killing a Link**

To force kill a link, press the HOME key. This will drop the link immediately.

#### **8.3.2.3 Ending a QSO**

Press either ALT-D (this sends the END QSO text) or ALT-SHIFT-D (sends no additional text).

## **8.4 SITOR Operation (SITOR Operating Mode only)**

This mode is invoked through the Configure file. When switching between this mode and Amateur Mode power must be turned off and back on or by pressing the reset button on the modem. This section is for those users that have setup the program using the SITOR Operation for ship to shore operation.

### **8.4.1 ARQ Listen Mode**

This menu option places the SG7200 into a mode where the unit will copy the linked traffic between two SITOR stations. When operating in this mode the SG7200 will not respond to SITOR link requests.

To enter SITOR Listen Mode select the ARQ Listen option in the SITOR menu.

### **8.4.2 FEC Listen / Standby Mode**

The FEC Listen/Standby mode allows the SG7200 to copy and





translate SITOR FEC (forward error correction) traffic from another station. The unit will also allow SITOR ARQ link requests in this mode of operation.

#### **8.4.2.1 FEC Operations**

FEC operation are "one-way" forms of communications. This can be convenient for "round table" operations involving more than one other stations. There are only three active controls required for FEC operation. There are Page Up which places the TNC into transmit mode, Page Down which places the TNC into receive mode after the appropriate idle sequence and the End Key which provides a formatted changeover to receive mode.

To operate in FEC mode, first place the TNC into the appropriate mode using the Menu, right mouse click or special key option. Then press Page up to go into the transmit mode. When ready to receive press Page Down.

You may PANIC Kill the transmitter at any time by pressing the HOME key.

#### **8.4.2.2 ARQ Operations**

ARQ operations are characterized as two stations in a "linked" QSO. The advantage of ARQ operation is that it is virtually error free. When a station does not receive a data frame correctly it will "REQUEST" a repeat of the data frame.

##### **8.4.2.2.1 Linking to Another Station**

Press ALT-C and enter the SELCAL of the desired station press enter when ready.

##### **8.4.2.2.2 Killing a Link**

To force kill a link,. press the HOME key. This will drop the link immediately. This places the SG7200 into a "dead" mode. To be able to accept calls, place the SG7200 into SITOR Standby mode using the appropriate entry in the SITOR menu.

##### **8.4.2.2.3 Ending a QSO**

Press either ALT-D (this sends the END QSO text) or ALT-SHIFT-D (sends no additional text). The ALT-D text can be modified in the AMTOR/SITOR tab of the Operating parameters menu option. This is located under the SETUP menu.



### 8.4.3 Free Channel Mode

This mode of operation allows the SG7200 to operation in SITOR Free channel mode. Free channel mode allows the 7200 to beacon on the current channel using a morse code identification followed by a series of 8 ARQ bursts.

The program will report SITOR Standby with a link status indication of “Free Channel Mode”. To exit this mode of operation press either the Home key or select either ARQ Listen mode or FEC Listen / Standby from the SITOR menu.

Note that for Free channel mode to be enabled, the Free Channel CW ID must be filled in with the correct information. Normally this is in the form of “DE SGC” and that the Free Channel Suffix is filled in with the correct two letter and two digit suffix.

To adjust the Free channel burst timing the two digits in the suffix must be changed. The time delay can be calculate by by mulitplying the two digits by .45. This will give the time delay in seconds.

## 9.0 Logging Operation

To access the logging window press the F3 key. Each connect window has it own individual log screen. These windows may be toggled on and off pressing F3. Shown below is the layout of the logbook.

### 9.1 Entering a Callsign

The Callsign entry dialog box is used to enter the callsign/Selcal of another station. Press the F2 key to access this dialog box. You may also double click on the callsign/Selcal in the receive window and select the Callsign option in the popup menu.

Once the callsign/Selcal is entered into the box, press the enter key. This will copy the callsign/Selcal into the logbook of the program. If the station is in the current log, his last QSO information will be displayed in the minilog at the top of the window. Also any required fields of the log will be filled in with the correct information.

If the station is not found in the logbook, the program will search any external callsign servers that you might have installed.

### 9.2 Entering the other Operators Name

To enter the name of the other station into the log, press CTRL-N, enter the name and press enter. You may also highlight or double click on the name in the receive window and pick the Name option in the popup menu.



### 9.3 Entering the other Stations QTH

To enter the QTH (location) of the other station into the log, press CTRL-Q, enter the City, State, Province etc. and press enter. You may also highlight the QTH with the mouse and select the QTH option in the popup menu.

### 9.4 Entering the Operating Frequency

To enter the current frequency into the log, press CTRL-F, enter the frequency and press enter.

## 10.0 Setting Up Operating Parameters

The operating parameters tab box allows the user to customize frequently used operations for all modes of operation. Macros are supported in these fields to simplify communications.

To use, select the operating mode tab from the list and make required changes. To navigate through the files press the TAB key. When finished press the OK key to save the changes or CANCEL to abort the changes.

Here are a few basic recommendations.

1. Limit the number of lines in your CQ.
2. Allow ample time between CQ's (CQ Delay) so that the other station can link to you. In ARQ Modes this can take several seconds to occur.

NOTE: The Apply Button is not currently used.

### 10.1 CQ Repetitions

This parameter controls the number of times the program will "CALL" an automated CQ.

Example; if the user specifies "5" for this value, the program will transmit an automated CQ 5 times. Each CQ will be separated by the amount of time delay that has been entered into "CQ Delay" .

### 10.2 CQ Lines

The option allows the user to specify the number of lines that will be sent in the CQ.

Example parameter set to 4.

```
CQ CQ CQ de WI0ABC WI0ABC WI0ABC
CQ CQ CQ de WI0ABC WI0ABC WI0ABC
CQ CQ CQ de WI0ABC WI0ABC WI0ABC
CQ CQ CQ de WI0ABC WI0ABC WI0ABC
```



This would be followed by the CQ terminator.

### 10.3 CQ Delay

Specified the amount of time between automated CQ's. This time is specified in seconds. A good compromise is between 45 and 60 seconds.

### 10.4 CQ Text

The CQ Text is user defined to customized operation for various modes of operation. Macros are supported to simplify multi-user station.

Example: CQ CQ CQ de ~sc ~sc ~sc would be sent as

CQ CQ CQ de WI0ABC WI0ABC WI0ABC

### 10.5 CQ Terminator

The CQ terminator is used as the last line of a CQ, this is optional and may be blank if desired.

Example:

CQ CQ CQ de WI0ABC WI0ABC WI0ABC  
CQ CQ CQ de WI0ABC WI0ABC WI0ABC  
CQ CQ CQ de WI0ABC WI0ABC WI0ABC  
CQ CQ CQ de WI0ABC WI0ABC WI0ABC  
Please ARQ de WI0ABC KK (CQ Terminator text)

### 10.6 End Key Text

The End key text is used to define the text that is sent when the user presses the END key on the keyboard. This key is used as changeover key in all modes.

The Page Down key may also be used as a changeover key. No additional text will be appended to the outgoing data.

### 10.7 Identification Text ALT-I

The Identification text allows the user to define a string of characters that will be sent whenever the Alt-I key sequence is pressed or when the user click on the ID button in the tool bar.

Example ~hc de ~sc (~sc)...~r~r

### 10.8 End QSO Text

The End QSO text is sent whenever the user presses the ALT-D key sequence or clicks on the QRT button in the tool bar.

The text will be sent as data and after the text is sent the link will be



dropped normally. No special characters are required at the end of the text. All necessary changeover or link commands are handled by the program.

### **10.9 Logging/Text Parameters**

The logging parameters deal with how the program handles logging operation. There are two modes of operation. These are Automatic and Manual. The automatic mode only works in linked modes of operation. All other modes (RTTY, ASCII etc.) must be manually saved.

The Add Linefeed option (not shown below) is used to add a linefeed character after every carriage return. This parameter is used only for NON-Packet modes and only for typed text or brag text. File transfers are not effected by this option. The default state for this option is OFF.

## **11.0 Setup Menu**

### **11.1 Communications Port**

This option allows the user to select the communications setting for the SG-7200 DSP SmartModem. Please note that the port settings are currently fixed in the SG-7200 to 9600 Baud, 8 Data Bits and 1 Stop Bit.

### **11.2 Transceiver Interface Setup**

This menu selection allows the user to select and configure a transceiver interface for the program. This option should only be selected if the radio is directly connected to the computer via an RS232 port.

Make sure that you have the correct communications settings for the radio. If you are not sure about your radios frequency control capabilities set this option to NOT Installed.

### **11.3 Directory / File Transfer Setup**

This menu option allows the user to select the default directories for file transfers. During the installation process the Upload, Download and ANSI directories will be set to the SGCCOM\FILES directory.

The Text Editor button allows the user to select the default text editor that will be called by the program for editing operations. During program installation this is set to the standard NOTEPAD.EXE program that is distributed with Windows 3.1 and Windows 95.

Automatic Receive Binary files is currently not used. This option will be enabled as data transparent modes are released for the SG-7200.

### **11.4 Station Information**

This setup option allows the user to configure the Station information,

including Name, Location, Callsign and SELCAL. This information is loaded into the TNC at program startup.

### **11.5 Set Time Zone**

This options allows the user to set the program clock to reflect the correct local and UTC time information. If you have problems with this setting, check for the presence of a SET TZ line in your config.sys or autoexec.bat file. If this exists remove or REM the line form the file and restart the computer

To set the program clock correctly use the following steps.

1. Select the "Setup Time Zone" option in the Setup Menu.
2. Enter the Hours offset from UTC.
3. Enter the Minutes Offset from UTC. Normally 0 or 30.
4. Click on the "East of Greenwich, England if your QTH is located east of this location.
5. Save changes clicking on the OK button.

Note : all changes are immediate.

### **11.6 Brag Text**

The brag text option allows the user to pre-program up to ten response sequences to ease normal communications. These may be transmitted at any time by pressing one of the ALT-0 to ALT-9 keys.

All program macros are usable in the brag text definitions.

### **11.7 Brag Files**

The brag file feature allows the user to pre-program up to 10 single key-stroke file transfers. These keystrokes are assigned to the CTRL-F1 through CTRL-F10 key. Once a file is assigned to a key, it can be sent at any time by pressing the appropriate control key or by using the Brag File function on the Right Mouse Button.

To create a new brag file use the following steps:

1. Select the Brag File Option in the Setup Menu.
2. Select one of the CTRL-F1 to CTRL-F10 buttons on the dialog box that is provided.
3. Enter the name of the file you wish to create in the FileName box in the file selector dialog box.
4. Press the OK key. If the file does not already exist then the program will execute the Text Editor. By default this is the Notepad program provided with Windows.
5. Type any text you wish into the text editor and when complete use





the Save option in the File Menu. And then use the Exit option in the File menu to return to SGCCOM.

6. To save the changes to the Brag file setup. Press the OK button on the dialog box.

7. This completes the creation and assignment of the brag file for the desired CTRL F key.

To assign an existing file use the following steps.

1. Select the Brag File Option in the Setup Menu.

2. Select one of the CTRL-F1 to CTRL-F10 buttons on the dialog box that is provided.

3. Using the file selector dialog box that is displayed navigate using the directories and file until the desired file is found.

4. Click on the desired file and then Click the OK button on the dialog box.

5. This completes the assignment of an existing file.

### **11.8 Setting the Screen Colors**

The program allows the user to select the colors that are used for displaying text to the screen. This allows for both foreground and background color definitions.

To select a new color click on the appropriate Port and select Receive or Transmit Color. For the SG-7200 only the Port One parameter is used. After you have selected either the Receive or Transmit color you will be prompted for the background color. Once this is selected you will be prompted for the Text Color. After you have made your selections the Sample box will display the selected color combination. If high readability is desired opt for a dark text on a light background. The windows default White background with black text is still a good alternative.

### **11.9 Callbook Options**

This options allows the selection of an external callbook server. This program supports Buckmaster, SAM, QRZ! and Radio Amateur Callbook.

Make sure to correctly entry the disk drive when modifying these parameters.

### **11.10 Wave File Setup**

This option allows the user to select how the program will announce various program events. Both voice and CW announcements are available in the program.

To change a wave file setting, press the button to the left of the displayed file name and select the new .WAV file to be used.



This option requires the installation of a sound card. The CW feature uses the internal PC speaker.

## **12.0 TOR Modes**

### **12.1 AMTOR Listen**

This menu option place the TNC into AMTOR mode with FEC and ARQ listen enabled. This allows the user to monitor other AMTOR stations sending FEC or linked ARQ communications.

### **12.2 AMTOR Standby**

This option select AMTOR mode with all monitoring options disabled. This allows the station to monitor a frequency without filling the receive buffer with monitored traffic.

### **12.3 SITOR**

This menu option places the TNC into SITOR mode. All monitoring is disabled in SITOR mode.

## **13.0 Baudot Menu Option**

This menu option has the setting for the ASCII and Baudot mode of operation. Each menu option selects the displayed mode and operating speed.

To switch to Baudot mode (normal amateur operation) press the ALT-B key. The user may also change the speed while in receive mode by pressing the “+” or “-” buttons that are located on the toolbar.

## **14.0 Misc Menu**

### **14.1 Logbook**

The logbook option allows the user to display a list of log entries for the current station entered in the F2 call sign box.

Entries may be deleted or edited as desired.

Up to 100 entries are displayed. If you wish to scroll through the entire log book. Select the Update entry option and use the Up and Down arrows in the box. This will allow you to move to any entry in the log book.

### **14.2 Search Logbook**

This option allows you to search the contents of the logbook and display the results without effecting the current logbook (F3) contents.

Entries may be edited or deleted as required.

### **14.3 Command Mode**

This option allows the user to switch the TNC into command mode





(CMD:) prompt. This may also be used to switch back to Host Mode. This option may also be invoked by pressing ALT-F8.

#### **14.4 Callbook Search**

This menu option allows the user to search for a callsign from an external callsign server. Any data that is found will be displayed in a popup dialog box. The data that is displayed is variable based on the exact callsign server that is being used.

If you wish to copy this data, simply highlight the data with the mouse and press CTRL-INSERT. This will copy the data to the clipboard.

### **15.0 TNC Menu**

#### **15.1 Enter Command**

This menu option allows the user to directly enter TNC command to the controller. This may also be accessed by pressing the F11 key. This option will not normally be used as all parameter settings can be accessed via the Gain or Parameters dialog boxes that are also located in the TNC menu.

#### **15.2 Switch Ports F4**

This menu command allows the user to select either port 1 or port 2 on the SG-7200 DSP SmartModem. The program will save this information and will select the last port used on the next program start. The current port is always displayed at the top of the display window. It is also possible to select this command by pressing the F4 key.

#### **15.3 Set Port Gains F6**

This dialog box consists of two controls to set the gain parameters of the SG-7200. These parameters are loaded at the startup of the program.

##### **15.3.1 Input Gain**

This control is activated by pressing the Up and Down arrows next to the parameter. This will control the level of the input gain to the SG-7200. The larger the value the lower the audio input signal that is required for the for the SG-7200. The nominal values for this control is 4. This value is loaded each time the program is started or at any time the value is changed.

##### **15.3.2 Output Attenuator**

This control sets the output level from the SG-7200 to the radio. The lower the value the higher the output level that is supplied to the audio input of the transmitter. The nominal value for this com-

mand is 0. This value is loaded each time the program is started or at any time the value is changed.

## **15.4 Set TNC Parameters F7**

The TNC parameters control the timing and general characteristics of the SG-7200. These parameters are loaded each time the program is started. If you make a change and wish to revert to the last settings, press the Cancel key.

### **15.4.1 AAB WRU Text On**

This parameter controls the TNCs response to the CTRL-E character used in AMTOR to request the AAB (auto-answerback) text. When this flag is checked the TNC will report the AAB text when the CTRL-E character is received, when this occurs the TNC will seize the link, send the AAB text and return to receive mode. When this parameter is un-checked the CTRL-E character will be ignored.

### **15.4.2 RTTY Diddle On**

This parameters controls the RTTY diddle feature in the SG-7200. When the parameter is checked the TNC will alternate between the Mark and Space signals when no data is present in the transmit buffer and the TNC is in transmit mode. The default for this option is On.

### **15.4.3 Reverse Receive Tone On**

This option controls the received Mark/Space polarity. This has the same effect as changing the radio between upper sideband and lower sideband. The default for this option is Off. It is also available on the program toolbar.

### **15.4.4 Reverse Transmit Tone On**

This option controls the transmitted Mark/Space polarity. This has the same effect as changing the radio between upper sideband and lower sideband. The default for this option is Off. It is also available on the program's toolbar.

### **15.4.5 Unshift On Space On**

This option controls whether the TNC reverts to Letter case when a space character is encountered in RTTY mode. The default for this parameter is On.

### **15.4.6 AMTOR Control Delay**

This parameter sets the control timing in AMTOR mode. The





default for this parameter is 5.

#### **15.4.7 AMTOR Tx Delay**

This parameter sets the link timing for AMTOR operations. Under normal operation a Tx Delay of 30 to 40 is used. If the two stations are very close to one another a larger value may be required. The default for this parameter is 30 ms.

#### **15.4.8 AAB Text**

The AAB Text parameter is the text that is sent upon receipt of the CTRL-E character in AMTOR operation. This text is set only if the AAB WRU Text Flag is set to On. The default for this parameter is DE plus the SELCAL defined in the Station Information menu.

### **16.0 View Menu**

The View menu controls the state of the various status indicators and control windows that are present in the program. This gives the user full control over displaying the MiniLog, Toolbar and other items.

#### **16.1 Toolbar**

This menu option controls the status of the program toolbar. This is normally checked.

This parameter is not saved and will revert to the default setting on each program start.

#### **16.2 Status Bar**

This option controls the status line that is at the bottom of the program window. This status line gives information on the current menu selection, time in Local and UTC time and the current frequency if transceiver control is selected.

#### **16.3 TNC Status**

This option controls the TNC status bar at the bottom of the TNC window. This status line gives indications of the current mode, current speed and current link status.

#### **16.4 MiniLog**

This menu option controls the status of the status line at the top of the TNC window. This gives the current stations callsign, name and location as well as the last time, date and operating mode of any previous contacts.



## **17.0 Window Menu**

### **17.1 Cascade**

This menu option will cascade all program windows within the program window space. This is handy when several windows are open (when using two SG-7200 controllers) or viewing ANSI graphics. The current window on top remains in focus.

### **17.2 Tile**

This option allows the user to tile multiple windows. This allows simultaneous viewing of both windows at the same time. The window in focus is placed at the top.

### **17.3 Arrange Icons**

This allows the user to arrange icons that have been created by minimizing windows.

## **18.0 Help Menu**

### **18.1 Index**

This menu option allows the user to access the on-line help system for the program.

### **18.2 Special Keys**

This menu option allows the user to review the special key options that are available for use in the program

### **18.3 About SGCCOM**

This displays the program information box giving the current release version as well as information about memory and GDI usage. It also gives information about the current firmware version of the controller.



# **Host Mode Documentation for the SG-7200 Controller**

## **HOST MODE SECTION 3**



## 1.0 Introduction

This document contains information regarding the implementation of host mode control for the SG-7200 controller. This document is written to give programmers and implementers the necessary information to interface with the SG-7200 Controller.

The advantage of using a host mode is that it gives the programmer full control of the TNC and the ability to interrogate the controller at any time to find the current status and operating mode.

## 2.0 Entering Host Mode

To enter the Host mode. The user or program must send the command HOST <cr> to the SG-7200. At this point the controller will enter Host Mode.

## 3.0 Command Definitions

SOH	Defined as HEX 01
DLE	Defined as HEX 10
ETB	Defined as HEX 17

## 4.0 Command Program to TNC Structure

All Data and commands must be sent to the TNC in the form of Host Blocks. There are several of these forms of blocks. Each will be examined below.

### 4.1 Requesting Command Information from the Controller

If desired, the programmer may request the current status of any valid TNC command. To use this feature, send the following host block.

<SOH>	0x4F	Host Command (2Bytes)	<ETB>
-------	------	--------------------------	-------

The TNC will now respond with the Host Command followed by any additional numeric or character data. To send the OP (report OpMode) command to the TNC we would send.

<SOH><0x4F>OP<ETB>

### 4.2 Sending Command Data to the Controller

To send commands with data to the controller we use a similar approach. In this case the Host Command is followed by the parameters for the command.



<SOH>	0x4F	Host Command (2Bytes)	Parameters	<ETB>
-------	------	--------------------------	------------	-------

To send character data to the controller, send the character information as part of the parameters. For example to set the MYSELCAL parameter we can use the following format. Note that no spaces should be used between the Host command and the parameters.

<SOH>	0x4F	MG	SSGC	<ETB>
-------	------	----	------	-------

To Set a numeric value we use the same approach. For example if we wish to set the IGAIN command to 5 we would use the host block.

<SOH>	0x4F	IG	5	<ETB>
-------	------	----	---	-------

### 4.3 Sending Transmit data to the Controller

Data to be sent to the receiving station is sent using variable length host blocks. All transmit data is sent via the 0x20 command byte.

Example...

<SOH>	Command Byte <0x20>	Variable Length Data	<ETB>
-------	------------------------	-------------------------	-------

If the data contains any of the reserved characters (<SOH>, <DLE> or <ETB>) the <DLE> character must be PREFIXED by the <DLE> character. For example the data stream contains the characters <0x44><0x45><0x17><0x01><0x10>. Then the controlling program must send this data as <0x44><0x45><0x10><0x17><0x10><0x01><0x10><0x10>.

## 5.0 TNC to Command Program Structure

The TNC sends all responses to the controlling program via blocks of data or command information.

### 5.1 Received Data

Decoded data from the TNC will be sent to the controlling program in the following format. Received data is ALWAYS sent to channel 0x30.

<SOH>	Command Channel	Variable Length Data (may include pass characters)	<ETB>
<0x01>	<0x30>		<0x17>





If either the SOH, DLE or ETB characters are included in the data, these characters will be preceded by the DLE character. For example if the data contains the SOH character the TNC will send the sequence <DLE><SOH> as the replacement. This approach allows the <SOH>, <DLE> and <ETB> characters to be included in the data stream.

### 5.2 Echoed Data

By default, the TNC will echo ALL transmitted data back to the controlling program. The 0x2F channel byte will be used for this data. This allows the programmer to display data as it is sent from the controller to the receiving station. The same data passing rules apply as those that are found in the Receive Data section.

<SOH> <0x01>	Command Channel <0x2F>	Variable Length Data (may include pass characters)	<ETB> <0x17>
-----------------	---------------------------	---	-----------------

### 5.3 Command Responses

The TNC will respond to all valid commands with one of two different responses.

If the controlling program sends a command with parameters, the TNC will respond in the following way.

<SOH> <0x01>	Command Channel <0x4F>	CMD OpCode (2Bytes)	Command Status (1 Byte) See Table	<ETB> <0x17>
-----------------	---------------------------	------------------------	---	-----------------

Command Status Table

Command Status	Description	Notes
0x00	Command Acknowledged - OK	
0x01	Bad Parameter	
0x02	Too Many Parameters	
0x03	Not Enough Parameters	
0x04	Parameters Too Long	
0x05	Parameter Value out of Range	
0x06	Need Callsign	
0x07	Unknown Command	



Command Status	Description	Notes
0x08	Need VIA	Not used at this time. Reserved for Packet Operation if implemented.
0x09	Not While Connected	This command can not be used while connected to another station. For Example, it is not allowed to change timing parameters when connected in an ARQ mode.
0x0A	Need MyCall Parameters	Not used at this time. Reserved for Packet Operation if implemented.
0x0B	Need MYSELCAL Parameters	No SELCAL has been set in the TNC.
0x0C	Already Connected	Not used at this time. Reserved for Packet Operation if implemented.
0x0D	Not While Disconnected	Not used at this time. Reserved for Packet Operation if implemented.
0x0E	Different Connectees	Not used at this time. Reserved for Packet Operation if implemented.
0x0F	Too Many Outstanding Packets	Not used at this time. Reserved for Packet Operation if implemented.
0x10	Clock not Set	Not used at this time. Reserved for Packet Operation if implemented.
0x15	Not in this Mode	This command is not available in this operating mode. Not currently used.

#### 5.4 Response to the “OP” Host Command

The OP Host command is used to report the current operating mode and operating conditions. The following table describes this responses.



Operating Mode	Byte 1	Byte 2	Byte 3	Byte 4	Byte 5	Byte 6	Byte 7
ASCII	<SOH>	0x4F	A	S	S1	<ETB>	
Baudot	<SOH>	0x4F	B	A	S1	<ETB>	
AMTOR Stby	<SOH>	0x4F	A	M	LS	'R'	<ETB>
AMTOR Listen	<SOH>	0x4F	A	L	LS	'R'	<ETB>
AMTOR Fec	<SOH>	0x4F	F	E	LS	S1	<ETB>
AMTOR ARQ	<SOH>	0x4F	A	C	LS	S1	<ETB>
SITOR Stby	<SOH>	0x4F	S	2	LS	'R'	<ETB>
SITOR Listen	<SOH>	0x4F	S	2	LS	'R'	<ETB>
SITOR Fec	<SOH>	0x4F	S	4	LS	S1	<ETB>
SITOR ARQ	<SOH>	0x4F	S	3	LS	S1	<ETB>

Legend of commands

S1 Transmit Status Byte

S if Transmit, R if Receive

LS Link Status Byte

Link Status	Description
0x30	Standby
0x31	Phasing
0x32	Changeover
0x33	Idle
0x34	Traffic
0x35	Link Error
0x36	Link Request



## 6.0 Command Set for SG-7200 (AMATEUR RADIO MODE)

CMD Command	Host OpCode	Value Range	Description
APE	A1	NA	Sets the master timing for AMTOR mode, this parameter is normally not used.
AAB	AU	NA	Sets the WRU auto-answerback response String
RAS	AB	45,75 or 110 Baud	Sets the ASCII mode Baudrate. There are two alternate forms of the command. These are "ABU" and "ABD". These command will raise or lower the current baud rate.
ACH	AG	NA	Forces AMTOR Breaking when TNC is linked ARQ
	AE	\$####	Sets the current memory location for reading. Example for mem location 9. \$0009.
ADE	AD	5..80	Set AMTOR tx delay to <xx> where xx = ms
ALI	AL	NA	Initiate AMTOR Listen mode (Mode L)
ALF	AI	Y/N	Set Auto Line Feed ON(=Y)/OFF(=N) This command ONLY effect CMD mode and does not effect HOST operations.
AMT	AM	NA	Change operating mode to AMTOR, force STBY.
	AO	0...250	Sets the ARQ timeout for PACTOR mode. If this value is set to 0, the timer is disabled.
ARQ	AC	Selcal	Format <SOH>ACselcal<ETB>
ASC	AS	na	Change operating mode to ASCII
BAU	BA	na	Change operating mode to Baudot
DAT			Set Date. Not Supported at this time
DIS			Not Supported in Host Mode
DSP			DSP <xx> ... issue commands to the DSP Not Supported in Host Mode at this time
FEC	FE	na	Initiate AMTOR FEC
HEL			Help Command. Not supported in Host Mode
IGA	IG	1..15	Set Input Gain
HOS	HO	Y/N	Enter Host Mode
MYS	MG	Selcal	Set Myselcal. Where Selcal is the Selcal address for example (SSGC)
OGA	OG	1..15	Set Output Attenuation
PAR	PG	callsign	Starts an ARQ call to another station. The call sign field is mandatory.
PBY	PT	na	Places TNC in PACTOR Standby Mode.
PDY	AD	5...100	Set the transmit delay in milli sec.



CMD Command	Host OpCode	Value Range	Description
PEL			Not supported in Host Mode. See PAR command.
PFO	TC	na	Clears the current transmit buffer.
PID	MF	callsign	Sets the TNC PACTOR ID. Maximum of 8 characters.
PIG	IG	1...15	Sets input gain – PACTOR Mode.
PLI		PN	na Set controller to PACTOR Listen Mode.
POG	IG	1...15	Set Output level for transmit – PACTOR Only.
PPO	P1	1/2	Set Radio Port 1/2- PACTOR implementation.
POR	P1	1/2	Set Radio Port 1/2
QUI			Quits the TNC Control program. Not Supported in Host Mode.
TCL	TC	na	Clears the transmit buffer
RAS	AB	45,75,110	Sets the ASCII Mode Baud Rate
RBA	RB	45,75,110	Sets the Baudot Mode Baud Rate
RCV	RC	na	Switch to Receive Mode
RFE			Enable FEC Listen mode. See AL host command.
RXR	RX	Y/N	Set receive reverse ON(=Y)/OFF(=N)
SEL			Not Supported, see ARQ command for Host implementation
SIT	S2	na	Change operating mode to SITOR, force STBY
SPE	S5	na	Sets the master timing for SITOR mode, this parameter is normally not used.
STA	OP	na	See Section on OP Response for more information regarding response to this command.
TIM			Set time. Not supported at this time
TXR	TX	Y/N	Set transmit reverse ON(=Y)/OFF(=N)
USO	US	Y/N	Set Unshift on space ON = Y/ OFF = N
XMI	XM	na	Set TNC to Transmit Mode
	ZF	na	This command returns the number of bytes remaining in the SG-7200 transmit buffer. This command is only available in HOST mode. The command response is in the form of XF#### Where #### is the number of bytes in ASCII format.
	ZS	na	This command can be used to report the current status of the transmit buffer. A return of \$01 indicates that data remains to be transmitted. A return of \$00 indicates the buffer is empty. Also See ZF host command. This command is only available in HOST Mode.



## 7.0 Command Set for SG-7200 (TOR Module CIRR 476/625)

CMD Command	Host OpCode	Value Range	Description
SAB	AU	text string	sets the answer back string. This may be empty if the answerback needs to be disabled.
SAR	AC	selcal	Format <SOH>ACselcal<ETB>. Selcal may be 4,5 or 9 characters with optional identifier. See SEL for selcal format options.
SBK			issues the ARQ "break-in" or "re-sync" when in ARQ listen.
SBY	S2	na	enters standby mode where TNC waits for FEC, SELFEC, or ARQ calls.
SCW	CW	text string	sets the CW-id. May be empty if the CW-id is disabled.
SDI	S5	0...5	sets the allowable signal distortion level. Progressive levels above zero (up to 5) will tighten the margin on when the limits of acceptable distortion will be reached and RQ's will be issued.
SDY	AD	??	sets the transmitter turn-on delay. This factor is multiplied by 8.3 ms
SEC	na	na	sets the "lclflg" to allow or not disable locally-generated echo.
SED	S0	na	returns to a state where low-level CCIR-625 waits command input. In this state it will not respond to FEC or ARQ - it is in the "dead", or "waiting commands" state.



CMD Command	Host OpCode	Value Range	Description
SEL	na See the SAR command	na	<p>enters SELCAL string for ARQ or SELFEC calls. String can be any 4 digits, 4 letters, 5 digits, or 9 digits followed by an optional "/" the two channel-free letters, followed by an optional decimal number that defines the gap between successive channel-free bursts.</p> <p>If the SELCAL is 4 letters, these form a CCIR476 call. If the SELCAL is 4 or 5 digits, a CCIR492 translation to CCIR476 is done. If the SELCAL is 9 digits, a CCIR625 translation is performed. If there is no "/" after the SELCAL, the call is made repeated for 60 sec. If there is a "/" followed by two letters after the SELCAL, the call will be preceded by a period in which the modem listens for the channel-free block formed by the two letters. If the channel-free block is not detected before the end of the period, the TNC returns to "dead" with an error code. If no digits follow the letters, a 15 sec. period is used, otherwise the period is determined from the decimal number formed from the digits multiplied by 450ms. For example, a value of 32 works out as <math>32 \times 450 = 15</math> sec.</p> <p>Note: do not use SEL while a link is in progress.</p>
SFC	S4	selcal	initiates a SELFEC call. Goes back to "dead" when terminated. SELFEC calling will be using CCIR625 protocol when the previous SEL command set a 9-digit call.
SFE	FE	na	initiates a FEC call. Goes back to "dead" when terminated.
SFI	T1	na	flushes the low-level input buffer.
SFO	TC	na	flushes the low-level output buffer.



CMD Command	Host OpCode	Value Range	Description
SID	MG This command may be sent twice, once for the 4/5 character selcal and the second time for the 9 character selcal	selcal	sets the TNC's identification. The ID may be 4 letters, 4 or 5 digits that would make the unit respond in CCIR476 mode. If the ID is 9 digits it will respond in CCIR625 mode. SID may be set twice, once with a CCIR476 and then with a CCIR625 identification. The TNC will then respond to either call. An optional "/" may follow the ID with two letters followed by an optional two digits. When the "/" and digits are present a channel-free signal will be sent formed by these letters. If the letters are followed by the digits, these digits form the time interval (digits x 450ms) that the modem will remain in standby before returning to "dead". If no digits are given, this delay is 15 sec. If no "/" and letters given the TNC never times out of standby. If the CW id is set (SCW) and free channel transmission is enabled, a free signal broadcast will consist of the CW-id followed by eight channel free blocks. CW-id is omitted when CW-id is null. If a dual ID is set, only the channel-free data from the last call will be used. Like for SELCAL, do not change ID on the fly.
SIG	IG	1...15	sets the audio input gain in +1.5dB steps. 0 - 15 is valid.
SKE	na		enters keyboard mode. Returns to command mode upon user entering the ESC key.
SLI	S3	na	Initiates ARQ listen mode. The user should enter keyboard mode to print traffic. Returns to "dead" when SOL or SOT issued.
SOG	OG	1...15	set the audio output attenuation in -1.5 dB steps. 0 - 15 is valid.
SOL	RC	na	sets an end-of-link request. This is recognized in ARQ send (SAR), FEC send (SFE), ARQ listen (SLI), and Test mode (STS). In these cases, the operation is terminated and the TNC returns to "dead" mode awaiting new commands. Note: If ARQ is attempted and it has not yet linked, this command will not affect the termination of the present mode. Use SED in this case.





CMD Command	Host OpCode	Value Range	Description
SOT	OV		sets an end-of-transmission. This causes an ARQ link to finish sending any pending traffic then change to the link receive by sending the +? group. Note that this command does not merely stuff data into a buffer, but actually checks and verifies that the link actually changed over. If needed, it will repeat sending +?. In FEC, this command finishes sending all pending traffic and behaves like SOL.
SOV			sets the "ovrflg" that allows the IRS to respond or not to +?
SPE	na	na	sets the CCIR-625 master timing. SGC's engineering personnel will determine the number of ppm that the 25.576 MHz crystal (X3) is off. This number will be multiplied internally by a constant to convert ppm to clock correction units to be added to the nominal value. This correction factor need to be included in the TNC's initialization file and be set up at boot time along with other settings such as date and time.
SPO	P1	1/2	sets the radio port. 1 or 2 is valid. Internally this is set as 0 or 1.
SRE			sets the "repflg" to allow or disable relinking after timeout.
SRP	RX	Y/N	determines whether or not the receive polarity needs to be normal or inverted. SRP 0, is for normal polarity, SRP 1 is for inverted polarity
SRS	RS	na	Resets the DSP and loads a fresh copy of the DSP CCIR-625 modem code. All modem working parameters (port, gains) is reset.
STP			determines whether or not the transmit polarity needs to be normal or inverted. STP 0, is for normal polarity, STP 1 is for inverted polarity
STS	na	na	enters a test mode where alternating mark and space are sent. Exit from test with DED, SOL, or SOT commands.
TAF	na	na	tests AFSK by cycling through the various AFSK tones. A new tone is emitted each time the command is executed.



CMD Command	Host OpCode	Value Range	Description
TAT	na	na	reads and displays the 625 status word. This value is passed as part of the opmode command.
TCS			displays the status of the low-level 625 output buffer.
TIM	na	na	checks whether the DSP is generating interrupts.
TPF	na	na	reads and displays the current status of 625 flags and other operational parameters
TT-	T2	na	reduces the timing correction parameter by the equivalent of 1 ppm.
TT+	T1	na	bumps the timing correction parameter by the equivalent of 1 ppm.