



Icom America, Inc.
2380 116th Ave NE
Bellevue, WA 98004
425.454.7619

AT-180

Automatic Antenna Tuner

Operating Instructions

and

Service Information

Compiled from the IC-706 Operating Instructions and Service Manual

◇ Optional AT-180 AUTOMATIC ANTENNA TUNER operation

The AT-180 automatic antenna tuner matches the IC-706MKIIG to the connected antenna automatically. Once the tuner matches an antenna, the variable capacitor angles are memorized as a preset point for each frequency range (100 kHz steps). Therefore, when you change the frequency range, the variable capacitors are automatically preset to the memorized point.

CAUTION: NEVER transmit with the tuner ON when no antenna is connected. This will damage both the transceiver and the antenna tuner.

Note:

- The AT-180 cannot be used for the 144/430 MHz band.
- When operating on the 144/430 MHz band, pushing the tuner switch selects the call channel (p. 39).
- The AT-180 can match both HF and 50 MHz bands. However, operation is different for the HF and 50 MHz bands.

TUNER OPERATION

• For the HF band:

Push [TUNER] to turn the tuner ON. The antenna is tuned automatically during transmission when the antenna SWR is higher than 1.5:1.

- When the tuner is OFF, the [TUNER] light goes out.

[TUNER/CALL]

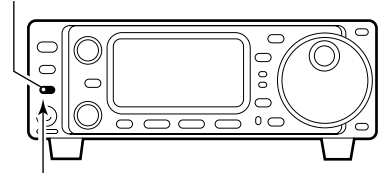

Lights to indicate the AT-180 is turned ON.

• For the 50 MHz band:

Push and hold [TUNER] to tune the antenna. If the [TUNER] light flashes slowly while transmitting, push and hold [TUNER] again to re-tune the antenna.

[TUNER/CALL]

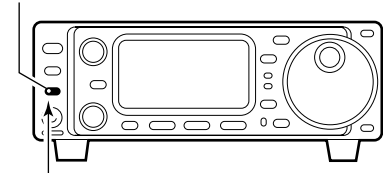

Flashes to indicate re-tuning is necessary.

MANUAL TUNING

During SSB operation on HF bands at low voice levels, the AT-180 may not be tuned correctly. In such cases, manual tuning is helpful.

Push and hold [TUNER] for 1 sec. to start manual tuning.

- CW mode is selected, a side tone is emitted, and the [TUNER] light flashes; then, the previous mode is selected.

[TUNER/CALL]

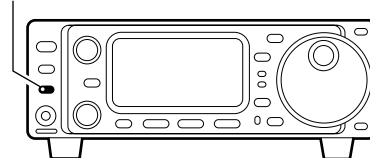

Push and hold for 1 sec. to start manual tuning.

If the tuner cannot reduce the SWR to less than 1.5:1 after 20 sec. of tuning, the [TUNER] light goes out. In this case, check the following:

- the antenna connection and feedline
- the antenna SWR (p. 26; meter function)

Through inhibit (HF bands only)

The AT-180 has a through inhibit condition. When selecting this condition, the tuner can be used at poor SWR's. In this case, automatic tuning in the HF bands activates only when exceeding SWR 3:1. Therefore, manual tuning is necessary each time you change the frequency. Although termed "through inhibit," the tuner will be "through" if the SWR is higher than 3:1 after tuning.

CONVENIENT

• Tuner sensitive condition (HF bands only)

If you require critical tuning at any time during transmission, select the tuner sensitive condition. See p. 55 for selection.

• Automatic tuner start (HF bands only)

If you want to turn OFF the tuner under conditions of VSWR 1.5:1 or less, use "automatic tuner on" and turn the tuner OFF. See p. 54 for turning the function ON and OFF.

■ AT-180 internal switch description

The optional AT-180 has 3 operating conditions for HF band operation. Select a suitable condition according to your antenna system.

- ① Remove the top cover of the AT-180.
- ② Set the tuner switches to the desired positions according to the table below.

SW	Position	Operation
S1	A (default)	The tuner operating condition is set by S2 described below.
	B	THROUGH INHIBIT The tuner tunes the antenna even when the antenna has poor SWR (up to VSWR 3:1 after tuning). In this case, manual tuning is necessary each time you change the frequency although the tuner automatically starts tuning when the VSWR is higher than 3:1. This setting is called "through inhibit," however, the tuner is set to "through" if the VSWR is higher than 3:1 after tuning.
S2	C	TUNER SENSITIVE CONDITION The tuner tunes each time you transmit (except SSB mode). Therefore, the lowest SWR is obtained at any given time. For SSB mode, the same condition as the "D" position.
	D (default)	NORMAL CONDITION The tuner tunes when the SWR is higher than 1.5:1. Therefore, the tuner activates only when tuning is necessary.

• Specifications for the AT-180

- Frequency coverage : 1.9–54 MHz
- Input impedance : 50 Ω
- Maximum input power : 120 W
- Minimum tuning power : 8 W
- Matching impedance : 16.7–150 Ω (HF band)
range 20–125 Ω (50 MHz band)
- Tuning accuracy : Less than SWR 1.5:1
- Insertion loss : Less than 1.0 dB
(after tuning)
- Power supply : 13.8 V DC/1 A (supplied from the transceiver's ACC socket)
- Dimensions (mm/in) : 167(W)×58.6(H)×225(D)
6⁹/₁₆(W)×2⁵/₁₇(H)×8⁷/₈(D)
- Weight : 2.4 kg; 5 lb 4 oz
- Supplied accessories : coaxial cable (1 m),
ACC cable (DIN 13 pins)

• AT-180 inside top cover

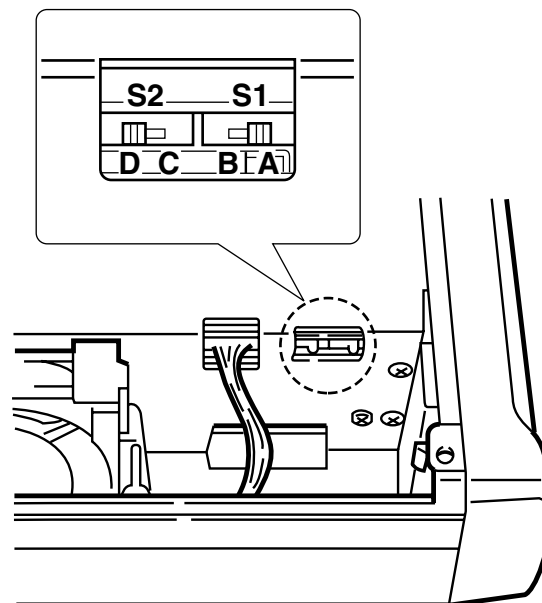

• Connector information for ACC(2) socket



PIN NO./NAME	DESCRIPTION
① 8 V	Regulated 8 V output. (10 mA max.)
② GND	Connects to ground.
③ SEND	Input/output pin. Goes to ground when transmitting (20 mA max). When grounded, transmits.
④ BAND	Band voltage output. (Varies with amateur band; 0 to 8.0 V).
⑤ ALC	ALC output voltage (–4 to 0 V).
⑥ NC	No connection.
⑦ 13.8V	13.8 V output when power is ON (1 A max).

5-2 AT-180

[TUNER UNIT]

REF. NO.	ORDER NO.	DESCRIPTION	
IC1	1120000970	IC	M54562P
IC2	1120000970	IC	M54562P
L1	6110003010	COIL	LA-488
L2	6110003020	COIL	LA-489
L3	6110003020	COIL	LA-489
L4	6110003030	COIL	LA-490
L5	6110003020	COIL	LA-489
L6	6110003030	COIL	LA-490
L7	6140002700	COIL	LR-307 (T130-2)
L8	6140002690	COIL	LR-308 (T68-6)
L9	6140002690	COIL	LR-308 (T68-6)
L10	6140002690	COIL	LR-308 (T68-6)
L11	6140002690	COIL	LR-308 (T68-6)
L13	2040000490	COIL	EXC-ELDR25C
R1	7410000170	ARRAY	RMX- 8 102K
R2	7410000170	ARRAY	RMX- 8 102K
C1	4620000110	VARIABLE	UV35 150P
C2	4010004260	CERAMIC	DE0907 SL 820J 3KV
C3	4010004280	CERAMIC	DE1207 SL 151J 3KV
C4	4010004250	CERAMIC	DE1007 SL 101J 3KV
C5	4620000110	VARIABLE	UV35 150P
C6	4010004250	CERAMIC	DE1007 SL 101J 3KV
C7	4010004280	CERAMIC	DE1207 SL 151J 3KV
C8	4010004250	CERAMIC	DE1007 SL 101J 3KV
C9	4040000150	BARRIERLAYR	UAT 05X 472K
C10	4040000150	BARRIERLAYR	UAT 05X 472K
C11	4040000150	BARRIERLAYR	UAT 05X 472K
C12	4040000150	BARRIERLAYR	UAT 05X 472K
C13	4040000150	BARRIERLAYR	UAT 05X 472K
C14	4040000150	BARRIERLAYR	UAT 05X 472K
C15	4040000150	BARRIERLAYR	UAT 05X 472K
C16	4040000150	BARRIERLAYR	UAT 05X 472K
C17	4040000150	BARRIERLAYR	UAT 05X 472K
C18	4040000150	BARRIERLAYR	UAT 05X 472K
C19	4040000150	BARRIERLAYR	UAT 05X 472K
C20	4040000150	BARRIERLAYR	UAT 05X 472K
C21	4040000150	BARRIERLAYR	UAT 05X 472K
C22	4010000520	CERAMIC	DD107-601 B 472K 50V
C23	4040000150	BARRIERLAYR	UAT 05X 472K
C24	4010004250	CERAMIC	DE1007 SL 101J 3KV
C25	4530000250	ARRAY	B8XC0112-32N
C26	4530000250	ARRAY	B8XC0112-32N
C27	4010005070	CERAMIC	DE0707 SL 390J 3KV
C28	4010005070	CERAMIC	DE0707 SL 390J 3KV
C29	4010004250	CERAMIC	DE1007 SL 101J 3KV
C30	4010000500	CERAMIC	DD104 B 102K 50V
RL1	6330001110	RELAY	NY-12W-K
RL2	6330001110	RELAY	NY-12W-K
RL3	6330001110	RELAY	NY-12W-K
RL4	6330001110	RELAY	NY-12W-K
RL5	6330001110	RELAY	NY-12W-K
RL6	6330001110	RELAY	NY-12W-K
RL7	6330001110	RELAY	NY-12W-K
RL8	6330001110	RELAY	NY-12W-K
RL9	6330001110	RELAY	NY-12W-K
RL10	6330001110	RELAY	NY-12W-K
RL11	6330001110	RELAY	NY-12W-K
RL12	6330001110	RELAY	NY-12W-K
RL13	6330001110	RELAY	NY-12W-K
RL14	6330001110	RELAY	NY-12W-K
RL15	6330001110	RELAY	NY-12W-K
J5	6510003100	CONNECTOR	RT01T-1.3B
J6	6510003100	CONNECTOR	RT01T-1.3B

[TUNER UNIT]

REF. NO.	ORDER NO.	DESCRIPTION	
WS1	8970022230	CABLE	1732 1.5D Coaxial (2)/TU
WS2	8600034870	CABLE	1732 P01-✕J01TU
WS3	8600034880	CABLE	1732 P02-✕J02TU
EP1	0910046761	PCB	B 4739A
MP1	8930030100	ANGLE	1414 ANGLE
MP2	8810003160	SCREW	Set screw A M3 X 6 [2 pcs]
MP3	8810003160	SCREW	Set screw A M3 X 6 [4 pcs]

[CTRL UNIT]

REF. NO.	ORDER NO.	DESCRIPTION	
IC1	1110000960	S.IC	NJM4558M(T1)
IC2	1110001850	IC	MC10116 L
IC3	1110001860	IC	MC10125 L
IC4	1120002251	S.IC	TC74ACT32F(TP1)
IC5	1120002241	S.IC	TC74AC112F(TP1)
IC6	1110000960	S.IC	NJM4558M(T1)
IC7	1180001070	S.IC	TA7805F(TE16L)
IC8	1180001140	S.IC	S-8437AF-ZA-T1
IC9	1180000110	S.IC	TD62164AF(TP1)
IC10	1180000110	S.IC	TD82164AF(TP1)
IC11	1140003610	S.IC	X24C04S8-2.7
IC12	1140004120	S.IC	M38022M2-138FP
IC13	1110001550	S.IC	S-8054ALB-LM-T1
IC14	1130003920	S.IC	TC4S69F (TE85R)
IC16	1130003920	S.IC	TC4S69F (TE85R)
IC17	1180000040	IC	TA78L009AP
IC18	1110002690	S.IC	NJM2903M-T1
Q1	1560000040	FET	2SK30ATM-Y
Q2	1520000530	S.TRANSISTOR	2SB1119S-TD
Q3	1590001220	S.TRANSISTOR	RN1302 (TE85R)
Q8	1530002690	S.TRANSISTOR	2SC4116-GR (TE85R)
Q9	1530002690	S.TRANSISTOR	2SC4116-GR (TE85R)
Q10	1510000780	S.TRANSISTOR	2SA1586-Y (TE85R)
Q11	1590001220	S.TRANSISTOR	RN1302 (TE85R)
Q12	1510000780	S.TRANSISTOR	2SA1586-Y (TE85R)
Q15	1530002690	S.TRANSISTOR	2SC4116-GR (TE85R)
D1	1790000070	DIODE	1SS237
D2	1790000070	DIODE	1SS237
D3	1710000580	DIODE	1SS265
D4	1710000580	DIODE	1SS265
D5	1710000580	DIODE	1SS265
D6	1710000580	DIODE	1SS265
D7	1750000220	S.DIODE	DA113W T107
D8	1750000220	S.DIODE	DA113W T107
D9	1790000240	DIODE	1SS99
D10	1790000240	DIODE	1SS99
D11	1790000070	DIODE	1SS237
D12	1790000070	DIODE	1SS237
D13	1750000220	S.DIODE	DA113W T107
D14	1750000220	S.DIODE	DA113W T107
D20	1710000550	DIODE	1S954
D21	1790001130	S.DIODE	D2FS4-4063
D24	1750000220	S.DIODE	DA113W T107
D25	1730000410	S.ZENER	RD5.1M-T2B2
D26	1730000410	S.ZENER	RD5.1M-T2B2
D29	1750000120	S.DIODE	DWA010-TE
D30	1750000120	S.DIODE	DWA010-TE
D31	1750000200	S.DIODE	1SS319 (TE85R)
D32	1790000070	DIODE	1SS237

S.=Surface mount

[CTRL UNIT]

REF. NO.	ORDER NO.	DESCRIPTION	
R123	7030001070	S.RESISTOR	MCR50JZHJ 33 Ω (330)
R124	7030003690	S.RESISTOR	ERJ3GEYJ 124 V (120 kΩ)
R127	7030003720	S.RESISTOR	ERJ3GEYJ 224 V (220 kΩ)
R129	7030003720	S.RESISTOR	ERJ3GEYJ 224 V (220 kΩ)
R129	7030003760	S.RESISTOR	ERJ3GEYJ 474 V (470 kΩ)
R130	7030003670	S.RESISTOR	ERJ3GEYJ 823 V (82 kΩ)
R130	7030003690	S.RESISTOR	ERJ3GEYJ 124 V (120 kΩ)
R131	7030003440	S.RESISTOR	ERJ3GEYJ 102 V (1 kΩ)
R132	7030003560	S.RESISTOR	ERJ3GEYJ 103 V (10 kΩ)
R133	7030003560	S.RESISTOR	ERJ3GEYJ 103 V (10 kΩ)
R134	7030003560	S.RESISTOR	ERJ3GEYJ 103 V (10 kΩ)
R135	7030003560	S.RESISTOR	ERJ3GEYJ 103 V (10 kΩ)
R136	7030003680	S.RESISTOR	ERJ3GEYJ 104 V (100 kΩ)
R137	7030003680	S.RESISTOR	ERJ3GEYJ 104 V (100 kΩ)
R138	7030003680	S.RESISTOR	ERJ3GEYJ 104 V (100 kΩ)
R139	7030003680	S.RESISTOR	ERJ3GEYJ 104 V (100 kΩ)
R140	7030003640	S.RESISTOR	ERJ3GEYJ 473 V (47 kΩ)
C1	4030008560	S.CERAMIC	C1608 CH 1H 300J-T-A
C2	4030006860	S.CERAMIC	C1608 JB 1H 102K-T-A
C3	4010005540	CERAMIC	HM60SJ SL 030C 500V
C4	4030006860	S.CERAMIC	C1608 JB 1H 102K-T-A
C5	4030008920	S.CERAMIC	C1608 JB 1C 473K-T-A
C6	4510003790	ELECTROLITIC	16 MV 10 SW
C8	4030008920	S.CERAMIC	C1608 JB 1C 473K-T-A
C9	4510003790	ELECTROLITIC	16 MV 10 SW
C11	4010005530	CERAMIC	HM60SJ SL 020C 500V
C12	4030007040	S.CERAMIC	C1608 CH 1H 180J-T-A
C13	4030007040	S.CERAMIC	C1608 CH 1H 180J-T-A
C14	4030007080	S.CERAMIC	C1608 CH 1H 390J-T-A
C15	4030008920	S.CERAMIC	C1608 JB 1C 473K-T-A
C16	4510003790	ELECTROLITIC	16 MV 10 SW
C18	4030007170	S.CERAMIC	C1608 CH 1H 221J-T-A
C19	4030007080	S.CERAMIC	C1608 CH 1H 390J-T-A
C20	4030006880	S.CERAMIC	C1608 JB 1H 472K-T-A
C21	4030007170	S.CERAMIC	C1608 CH 1H 221J-T-A
C22	4030006880	S.CERAMIC	C1608 JB 1H 472K-T-A
C24	4510003790	ELECTROLITIC	16 MV 10 SW
C25	4030008920	S.CERAMIC	C1608 JB 1C 473K-T-A
C26	4030008920	S.CERAMIC	C1608 JB 1C 473K-T-A
C27	4030007170	S.CERAMIC	C1608 CH 1H 221J-T-A
C28	4030006850	S.CERAMIC	C1608 JB 1H 471K-T-A
C29	4030008920	S.CERAMIC	C1608 JB 1C 473K-T-A
C30	4010005540	CERAMIC	HM60SJ SL 030C 500V
C31	4030007130	S.CERAMIC	C1608 CH 1H 101J-T-A
C32	4030007130	S.CERAMIC	C1608 CH 1H 101J-T-A
C33	4030006880	S.CERAMIC	C1608 JB 1H 472K-T-A
C34	4030006880	S.CERAMIC	C1608 JB 1H 472K-T-A
C35	4030006860	S.CERAMIC	C1608 JB 1H 102K-T-A
C36	4030006880	S.CERAMIC	C1608 JB 1H 472K-T-A
C37	4030008920	S.CERAMIC	C1608 JB 1C 473K-T-A
C38	4030007170	S.CERAMIC	C1608 CH 1H 221J-T-A
C39	4030006850	S.CERAMIC	C1608 JB 1H 471K-T-A
C40	4030008920	S.CERAMIC	C1608 JB 1C 473K-T-A
C41	4510003790	ELECTROLITIC	16 MV 10 SW
C43	4030008920	S.CERAMIC	C1608 JB 1C 473K-T-A
C44	4030008920	S.CERAMIC	C1608 JB 1C 473K-T-A
C45	4030008920	S.CERAMIC	C1608 JB 1C 473K-T-A
C51	4510004590	ELECTROLITIC	16 MV 470 HC
C52	4030010070	S.CERAMIC	C1608 X7S 1C 104K-T-A
C53	4030010070	S.CERAMIC	C1608 X7S 1C 104K-T-A
C54	4510003790	ELECTROLITIC	16 MV 10 SW
C55	4510004590	ELECTROLITIC	16 MV 470 HC
C56	4510005000	ELECTROLITIC	16 MV 220 HC
C57	4510003910	ELECTROLITIC	16 MV 47 HW
C73	4030010070	S.CERAMIC	C1608 X7S 1C 104K-T-A
C74	4030010070	S.CERAMIC	C1608 X7S 1C 104K-T-A
C75	4030009990	S.CERAMIC	C1608 CH 1H 200J-T-A
C76	4030009990	S.CERAMIC	C1608 CH 1H 200J-T-A
C77	4030008920	S.CERAMIC	C1608 JB 1C 473K-T-A
C78	4030008920	S.CERAMIC	C1608 JB 1C 473K-T-A
C79	4030008920	S.CERAMIC	C1608 JB 1C 473K-T-A
C80	4030008920	S.CERAMIC	C1608 JB 1C 473K-T-A
C81	4030008920	S.CERAMIC	C1608 JB 1C 473K-T-A
C82	4030008920	S.CERAMIC	C1608 JB 1C 473K-T-A

[CTRL UNIT]

REF. NO.	ORDER NO.	DESCRIPTION	
C83	4030008920	S.CERAMIC	C1608 JB 1C 473K-T-A
C84	4030008920	S.CERAMIC	C1608 JB 1C 473K-T-A
C85	4030008920	S.CERAMIC	C1608 JB 1C 473K-T-A
C86	4030008920	S.CERAMIC	C1608 JB 1C 473K-T-A
C87	4030008920	S.CERAMIC	C1608 JB 1C 473K-T-A
C88	4030008920	S.CERAMIC	C1608 JB 1C 473K-T-A
C89	4030008920	S.CERAMIC	C1608 JB 1C 473K-T-A
C90	4030006880	S.CERAMIC	C1608 JB 1H 472K-T-A
C91	4030006880	S.CERAMIC	C1608 JB 1H 472K-T-A
C92	4030006860	S.CERAMIC	C1608 JB 1H 102K-T-A
C93	4550002860	S.TANTALUM	TESVA 1V 224K1-8L
C94	4030006880	S.CERAMIC	C1608 JB 1H 472K-T-A
C95	4030008920	S.CERAMIC	C1608 JB 1C 473K-T-A
C96	4030008920	S.CERAMIC	C1608 JB 1C 473K-T-A
C97	4030008920	S.CERAMIC	C1608 JB 1C 473K-T-A
C98	4030006880	S.CERAMIC	C1608 JB 1H 472K-T-A
C101	4030008920	S.CERAMIC	C1608 JB 1C 473K-T-A
C102	4030008920	S.CERAMIC	C1608 JB 1C 473K-T-A
C103	4030008920	S.CERAMIC	C1608 JB 1C 473K-T-A
C106	4030008920	S.CERAMIC	C1608 JB 1C 473K-T-A
C108	4030006900	S.CERAMIC	C1608 JB 1E 103K-T-A
C109	4030006900	S.CERAMIC	C1608 JB 1E 103K-T-A
C110	4030007070	S.CERAMIC	C1608 CH 1H 330J-T-A
C111	4030007100	S.CERAMIC	C1608 CH 1H 560J-T-A
C112	4030007100	S.CERAMIC	C1608 CH 1H 560J-T-A
C113	4030008920	S.CERAMIC	C1608 JB 1C 473K-T-A
C114	4030008920	S.CERAMIC	C1608 JB 1C 473K-T-A
C115	4510003790	ELECTROLITIC	16 MV 10 SW
C120	4030006860	S.CERAMIC	C1608 JB 1H 102K-T-A
C122	4030006880	S.CERAMIC	C1608 JB 1H 472K-T-A
RL1	6330001090	RELAY	FXE-12
RL2	6330001090	RELAY	FXE-12
DS1	5040001720	LED	TLG221
S1	2220000420	SWITCH	ESD-11H120
S2	2220000420	SWITCH	ESD-11H120
J2	6510007020	CONNECTOR	TMP-J01X-V6
J4	6510007020	CONNECTOR	TMP-J01X-V6
J5	6510003530	CONNECTOR	S05B-EH-S
J6	6510003530	CONNECTOR	S05B-EH-S
J7	6510003530	CONNECTOR	S05B-EH-S
J8	6510003420	CONNECTOR	B06B-EH-S
J9	6510003460	CONNECTOR	B10B-EH-S
J11	6510003080	CONNECTOR	RT01T-1.0B
W1	7120000010	JUMPER	JPW 02A
W2	7120000010	JUMPER	JPW 02A
W3	7120000010	JUMPER	JPW 02A
W8	7030003860	S.JUMPER	ERJ3GE JPW V
W12	7120000010	JUMPER	JPW 02A
W13	7120000380	JUMPER	JPW 01 R-01
W14	7120000380	JUMPER	JPW 01 R-01
WS1	8970022240	CABLE	1732 1.5D Coaxial (2)/CT
EP1	0910040207	PCB	B 3932G
MP1	8510004470	CASE	331 VCO Case
MP2	8510008790	COVER	VCO Case cover (B) 1414
MP3	8930005410	SHEET	Insulator A

S.=Surface mount

[CON-A BOARD]

REF. NO.	ORDER NO.	DESCRIPTION
J1	6450001670	CONNECTOR TCS5093-10-4151
J2	6510018890	S.CONNECTOR 52559-1390
EP1	0910046642	PCB B 4658B

[CON-B BOARD]

REF. NO.	ORDER NO.	DESCRIPTION
Q1	1510000510	S.TRANSISTOR 2SA1578 T107 R
Q2	1540000450	S.TRANSISTOR 2SD1623-T-TD
Q3	1590000680	S.TRANSISTOR DTC114EU T107
D1	1750000270	S.DIODE 1SS301 (TE85R)
L1	2040000490	COIL EXC-ELDR25C
L2	6200000150	S.COIL NL 322522T-1R0M
L3	6200000150	S.COIL NL 322522T-1R0M
L4	2040000490	COIL EXC-ELDR25C
R1	7030007510	S.RESISTOR ERJ12YJ270H (27 Ω)
R2	7010003440	RESISTOR ELR20J 2.2 kΩ
R3	7030003410	S.RESISTOR ERJ3GEYJ 561 V (560 Ω)
R4	7030003440	S.RESISTOR ERJ3GEYJ 102 V (1 kΩ)
R5	7030003530	S.RESISTOR ERJ3GEYJ 562 V (5.6 kΩ)
R6	7030003680	S.RESISTOR ERJ3GEYJ 104 V (100 kΩ)
R7	7030003760	S.RESISTOR ERJ3GEYJ 474 V (470 kΩ)
C1	4510003910	ELECTROLITIC 16 MV 47 HW
C2	4510003790	ELECTROLITIC 16 MV 10 SW
C3	4030006880	S.CERAMIC C1608 JB 1H 472K-T-A
C4	4030006880	S.CERAMIC C1608 JB 1H 472K-T-A
C5	4510004990	ELECTROLITIC 16 MV 100 HC
C8	4030006880	S.CERAMIC C1608 JB 1H 472K-T-A
C9	4030006880	S.CERAMIC C1608 JB 1H 472K-T-A
C10	4030006880	S.CERAMIC C1608 JB 1H 472K-T-A
C11	4030006880	S.CERAMIC C1608 JB 1H 472K-T-A
C12	4030006880	S.CERAMIC C1608 JB 1H 472K-T-A
C13	4030006880	S.CERAMIC C1608 JB 1H 472K-T-A
C14	4030006880	S.CERAMIC C1608 JB 1H 472K-T-A
J3	6510018890	S.CONNECTOR 52559-1390
J4	6450000160	CONNECTOR TCS4470-01-1111
J5	6450001670	CONNECTOR TCS5093-10-4151
J7	6510018960	S.CONNECTOR B2B-PH-SM3-TB
WS1	8600034850	CABLE 1732 P01 ✕J06CO-B
EP2	0910046652	PCB B 4657B

[CON-C BOARD]

REF. NO.	ORDER NO.	DESCRIPTION
J8	6510007020	CONNECTOR TMP-J01X-V6
J9	6510007020	CONNECTOR TMP-J01X-V6
W3	7120000010	JUMPER JPW 02A
WS1	8970022220	CABLE 1732 1.5D Coaxial (1)/CO-C
EP3	0910046662	PCB B 4658B

[CHASSIS PARTS]

REF. NO.	ORDER NO.	DESCRIPTION
MF1	2710000580	FAN FBA06T12HF
MF2	2710000460	MOTOR MP28GA
MF3	2710000460	MOTOR MP28GA
J10	6510000370	CONNECTOR MR-DS
J11	6510000370	CONNECTOR MR-DS
P2	6510018980	CONNECTOR PHR-2
W9	8900006040	CABLE OPC-593 (N:13 L:50)
MP1	8210012880	PANEL 1732 Front panel
MP2	8010016390	CHASSIS 1732 Chassis
MP3	8110005660	COVER 1732 Cover
MP4	8930038280	ANGLE 1732 Angle
MP5	8930037010	RUBBER 1691 Fan rubber
MP7	8930005230	STAND Rubber foot (D) [2 pcs]
MP8	8930005790	STAND Foot (A)
MP9	8930005800	STAND Foot (B)
MP10	8010001490	STAND Stand (D)
MP11	8930037000	PLATE 1691 Grounding plate [2 pcs]
MP12	8810008660	SCREW PH BT M3 X 8 NI-ZU [2 pcs]
MP13	8810009030	SCREW RFH M3 X 8 ZK [2 pcs]
MP14	8810009030	SCREW RFH M3 X 8 ZK [2 pcs]
MP15	8810009030	SCREW RFH M3 X 8 ZK
MP16	8810009030	SCREW RFH M3 X 8 ZK [4 pcs]
MP17	8810008450	SCREW BiH M4 X 8 ZK [4 pcs]
MP18	8820000530	SCREW Flange bolt M4 X 8 NI
MP19	8850000140	WASHER Flat washer M 4 NI BS
MP20	8850001560	WASHER Int. tooth washer M 4
MP21	8810008660	SCREW PH BT M3 X 8 NI-ZU [2 pcs]
MP22	8810008660	SCREW PH BT M3 X 8 NI-ZU [2 pcs]
MP23	8810008660	SCREW PH BT M3 X 8 NI-ZU
MP24	8810008660	SCREW PH BT M3 X 8 NI-ZU [2 pcs]
MP25	8810008660	SCREW PH BT M3 X 8 NI-ZU [2 pcs]
MP26	8930038280	SHEET 1732 Sheet
MP27	8930038290	SHEET Insulator EA
MP29	8010015141	CHASSIS 1414 U-Chassis-1
MP30	8010015151	CHASSIS 1414 L-Chassis-1
MP31	8510008592	PLATE 1414 Shield plate-2
MP32	8930030111	PLATE 1414 Plate-1 [2 pcs]
MP33	8820000811	SCREW 1414 Screw-1 [4 pcs]
MP34	8810008630	SCREW PH BT M3 X 6 NI-ZU [2 pcs]
MP35	8810008630	SCREW PH BT M3 X 6 NI-ZU [2 pcs]
MP36	8810008630	SCREW PH BT M3 X 6 NI-ZU [3 pcs]
MP37	8810008630	SCREW PH BT M3 X 6 NI-ZU [5 pcs]
MP38	8810007840	SCREW RFH B1 M3 X 8 ZK [4 pcs]
MP39	8810007840	SCREW RFH B1 M3 X 8 ZK [3 pcs]
MP40	8810007840	SCREW RFH B1 M3 X 8 ZK
MP41	8810007840	SCREW RFH B1 M3 X 8 ZK
MP42	8950003200	Coupling UJ6-5 [2 pcs]
MP43	8510008750	PLATE 1414 A-Shield plate
MP44	8930038760	SHEET Insulating seet (H)
MP45	8310037080	PLATE 1732 Name plate

[UNPACKING]

REF. NO.	ORDER NO.	DESCRIPTION
W1	8900001160	CABLE OPC-125
W2	8900006120	CABLE OPC-597

S.=Surface mount

SECTION 9 OPTIONAL UNITS

9-1 UT-102 VOICE SYNTHESIZER UNIT

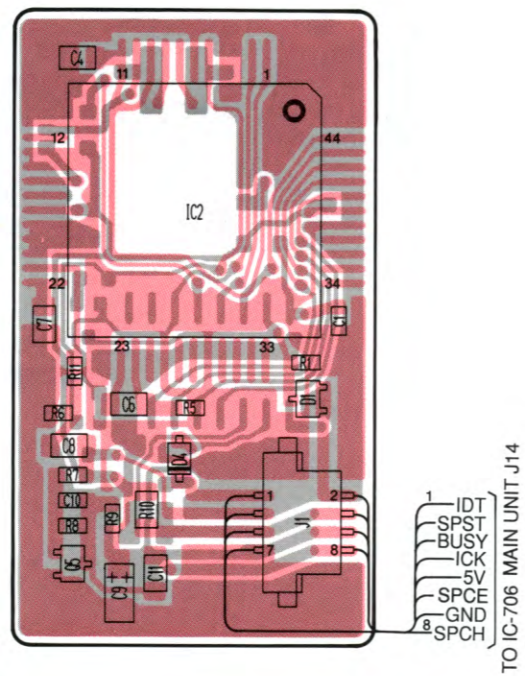
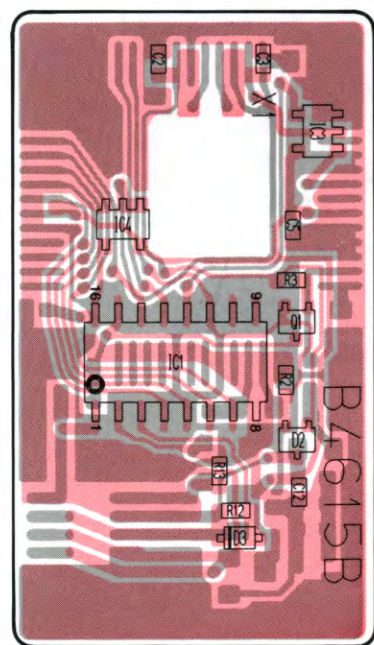
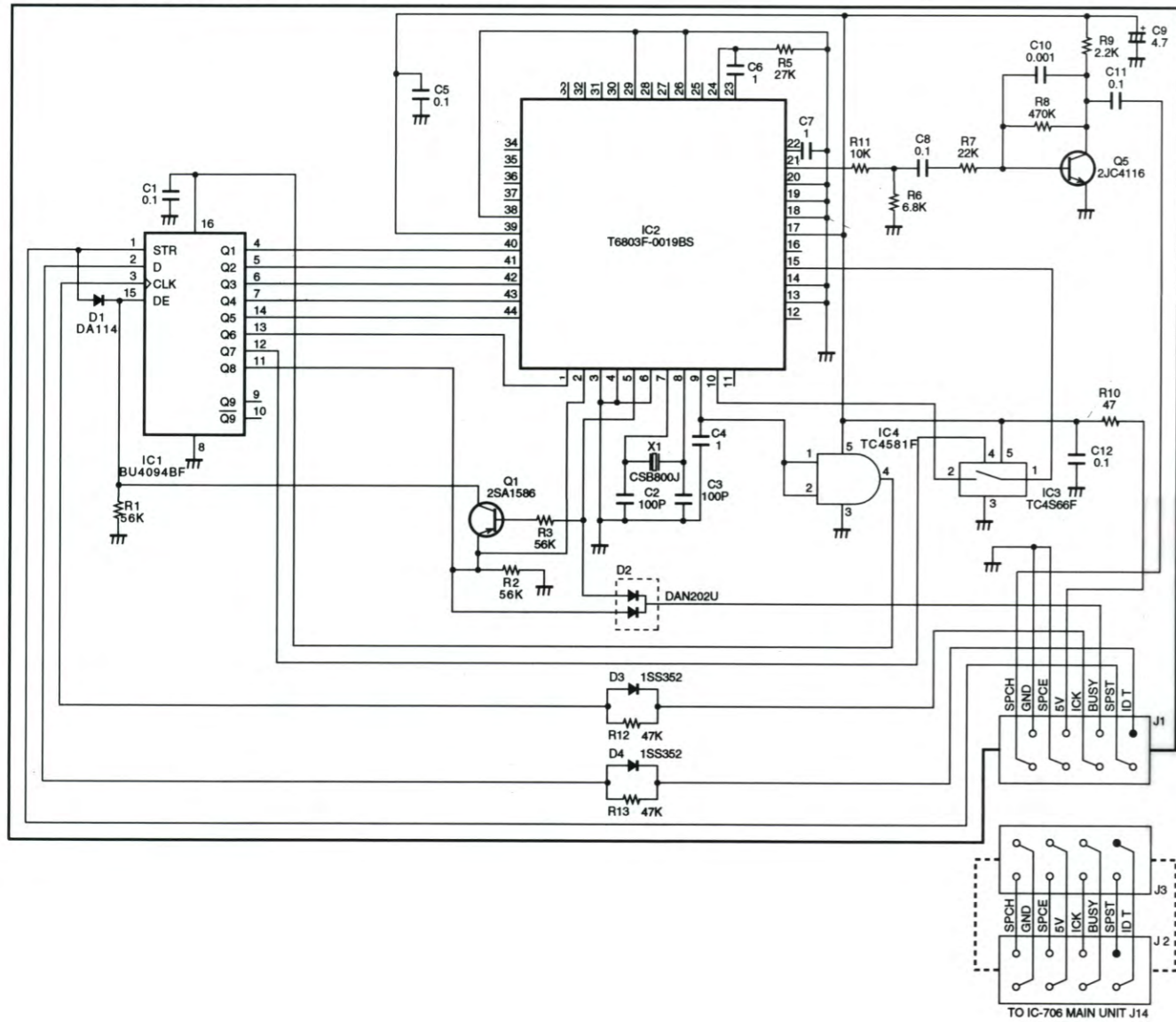

9-2 AT-180 HF/50 MHz AUTOMATIC ANTENNA TUNER

• TUNER UNIT

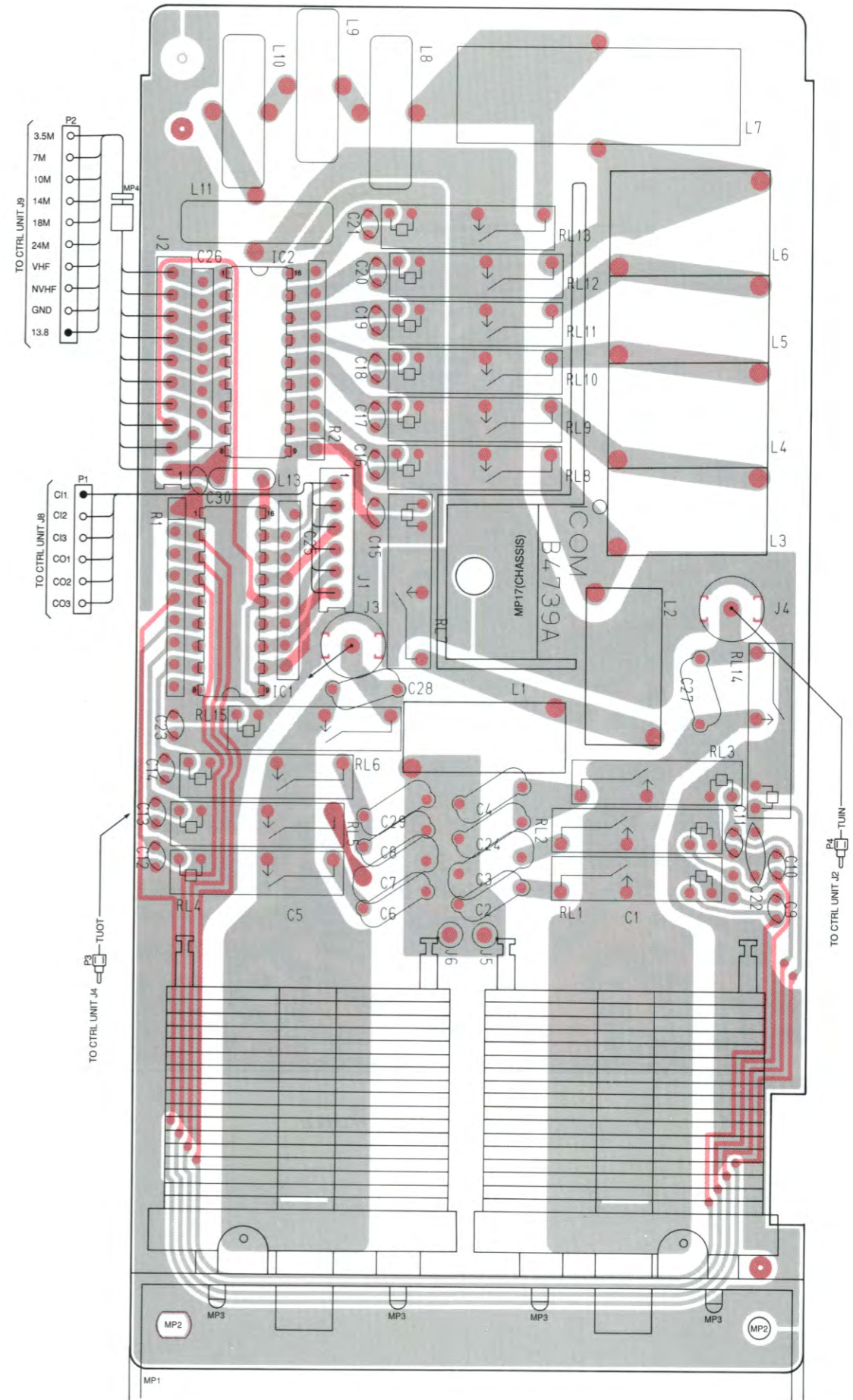

● CON-A UNIT

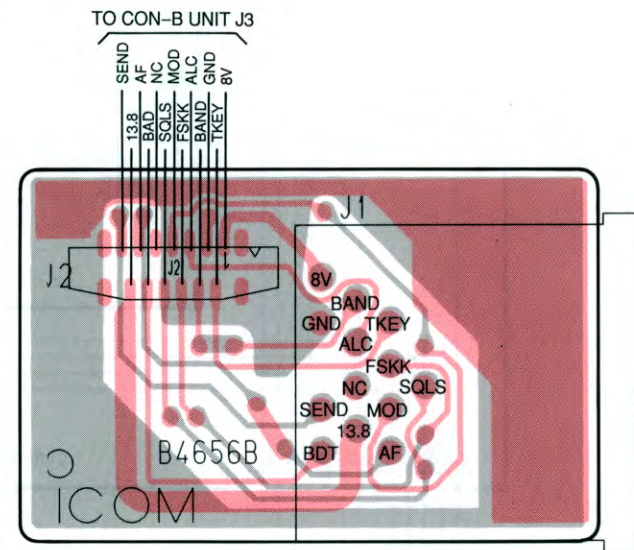

● CON-B UNIT

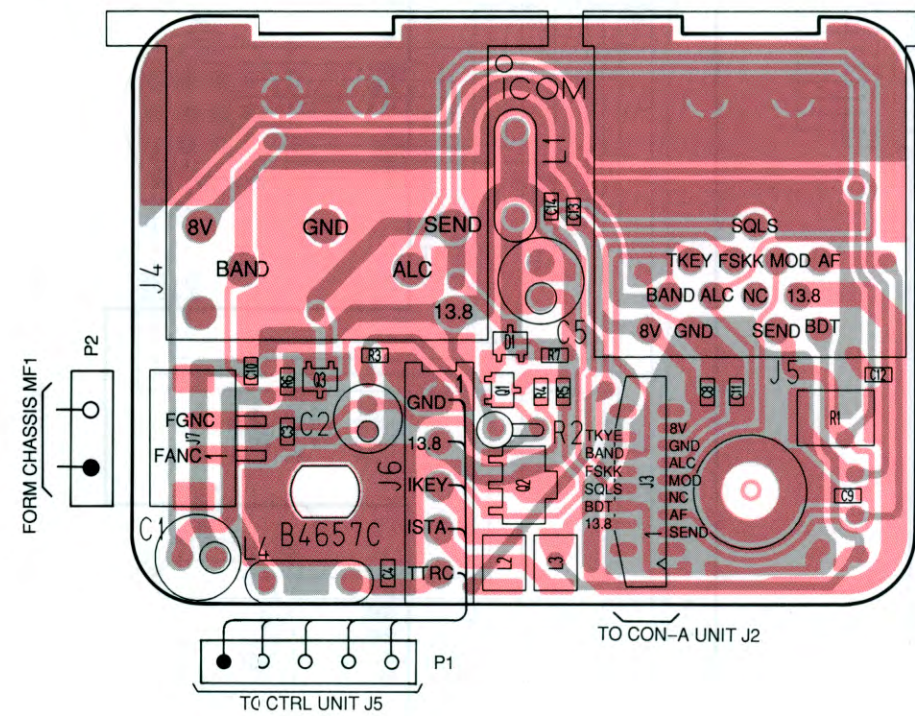

● CON-C UNIT

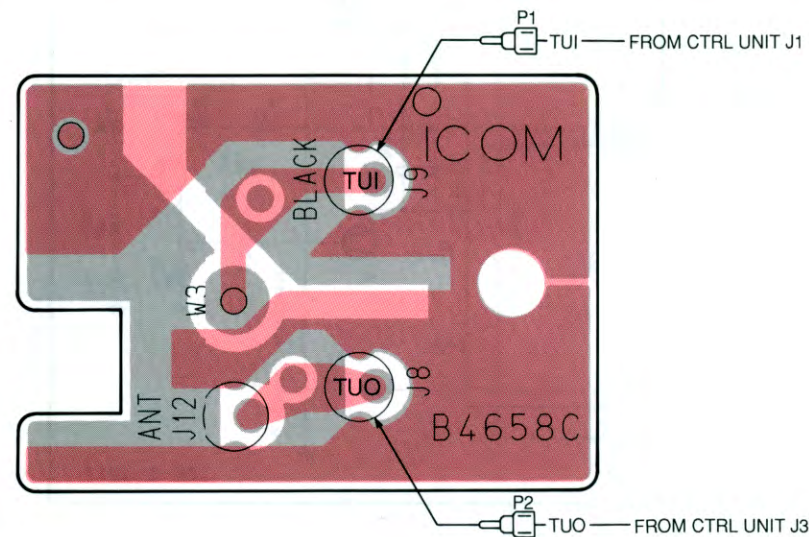

● CTRL UNIT

