



CI-V REFERENCE GUIDE

HF/50MHz TRANSCEIVER

IC-7610

Table of contents

Remote control	2
■ Remote control (CI-V) information	2
◇ CI-V connection	2
◇ Preparing	2
◇ About the data format	2
◇ Command table	3
◇ Command formats	10

Remote control

Remote control (CI-V) information

CI-V connection

The transceiver's operating frequency, mode, VFO and memory selection, can be remotely controlled using a PC.

- Use a USB cable (A-B type, user supplied) to connect the IC-7610 and the PC (controller).
The required USB driver and driver installation guide can be downloaded from the Icom web site.

Go to "<http://www.icom.co.jp/world>," and then click "Support," "Firmware Updates / Software downloads" in sequence.

① The download procedure on the web page may be changed without notice.

Connection example

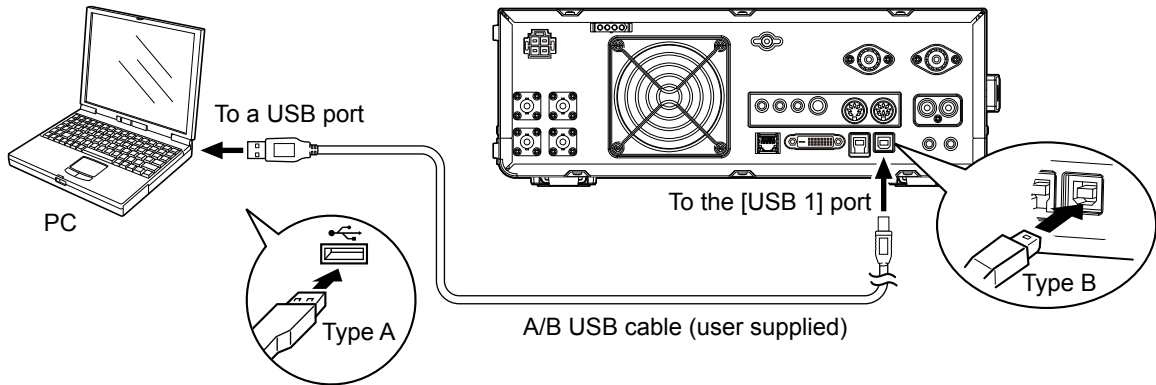

① Make the connection as short as possible. The transceiver may not be recognized by the controller, depending on the USB cable length.

Preparing

The Icom Communications Interface V (CI-V) is used for remote control.

To control the transceiver, first set its address, data communication speed, and transceive function. These settings are set in Set mode (Refer to the IC-7610 instruction manual).

About the data format

The CI-V system can be written using the following data formats. Data formats differ according to command numbers. A data area or sub command is added for some commands.

Controller to IC-7610

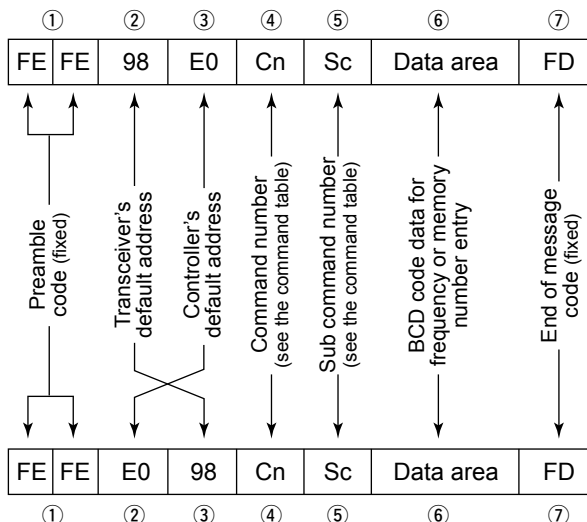

IC-7610 to controller

OK message to controller

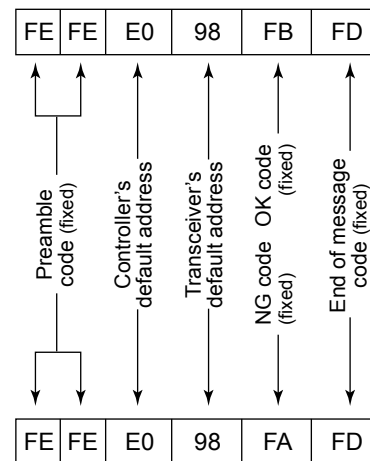

NG message to controller

Remote control

NOTE: Operation to the some control dials overrides CI-V commands. If a control dial (such as the AF Volume dial that has a mark on it) is rotated after sending a CI-V command, the command will be overwritten by the operation.

◇ Command table

Cmd.	Sub cmd.	Data	Description
00		see p. 10	Send frequency data (transceiver)
01		see p. 10	Send mode data (transceiver)
02		see p. 10	Read band edge frequencies
03		see p. 10	Read operating frequency
04		see p. 10	Read operating mode
05		see p. 10	Set operating frequency
06		see p. 10	Set operating mode
07			Select the VFO mode
	B0		Exchange main and sub bands
	B1		Equalize main and sub bands
	C0		Turn OFF Dualwatch
	C1		Turn ON Dualwatch
	C2*	00 or 01	Send/read the dualwatch setting (00=OFF, 01=ON)
	D0		Select the main band
	D1		Select the sub band
	D2*	00 01	Send/read main band selection Send/read sub band selection
08			Select the Memory mode
		0001 to 0099	Select the Memory channel (0001=M-CH01, 0099=M-CH99)
		0100	Select program scan edge channel P1
		0101	Select program scan edge channel P2
09		Memory write	
0A		Memory copy to VFO	
0B		Memory clear	
0E	00		Cancel the scan
	01		Start a Programmed/memory scan
	02		Start a Programmed scan
	03		Start a Δ F scan
	12		Start a Fine programmed scan
	13		Start a Fine Δ F scan
	22		Start a Memory scan
	23		Start a Select memory scan
	Ax (x=1 to 7)		Select Δ F scan span (x=1 (± 5 kHz), x=2 (± 10 kHz), x=3 (± 20 kHz), x=4 (± 50 kHz), x=5 (± 100 kHz), x=6 (± 500 kHz), x=7 (± 1 MHz))
	B0		Clear the Select channel setting
	B1		Set as select channel (The previously set number by CI-V is set after turning power ON, or "1" is selected if no selection is performed.)
		01 to 03	Set the channel as a Select channel (01=SEL1, 02=SEL2, 03=SEL3)
	B2	00 to 03	Set the Select memory scan channel (00=ALL, 01=SEL1, 02=SEL2, 03=SEL3)
	D0		Set Scan resume OFF
D3		Set Scan resume ON	
0F		00	Read Split OFF setting
		01	Read Split ON setting
	00		Turn OFF the Split function
	01		Turn ON the Split function
10*		00 to 08	Send/read the tuning step (00=OFF (10 Hz or 1 Hz), 01=100 Hz, 02=1 kHz, 03=5 kHz, 04=9 kHz, 05=10 kHz, 06=12.5 kHz, 07=20 kHz, 08=25 kHz)
11*		00	Send/read attenuator OFF setting
		03	Send/read 3 dB attenuator setting
		06	Send/read 6 dB attenuator setting
		09	Send/read 9 dB attenuator setting
		12	Send/read 12 dB attenuator setting
		15	Send/read 15 dB attenuator setting
		18	Send/read 18 dB attenuator setting
		21	Send/read 21 dB attenuator setting
	24	Send/read 24 dB attenuator setting	

Cmd.	Sub cmd.	Data	Description
11*		27	Send/read 27 dB attenuator setting
		30	Send/read 30 dB attenuator setting
		33	Send/read 33 dB attenuator setting
		36	Send/read 36 dB attenuator setting
		39	Send/read 39 dB attenuator setting
		42	Send/read 42 dB attenuator setting
	45	Send/read 45 dB attenuator setting	
12*	00* ¹	00 or 01	Select/read ANT1 selection (00=RX ANT OFF, 01=RX ANT ON)
	01* ¹	00 or 01	Select/read ANT2 selection (00=RX ANT OFF, 01=RX ANT ON)
13	00		Speech all data with voice synthesizer (S meter level, frequency and mode)
	01		Speech the operating frequency and S meter level by voice synthesizer
	02		Speech the operating mode by voice synthesizer Ⓞ The mode is announced after the ongoing speech.
14*	01	0000 ~ 0255	Send/read the AF level (0000=min. to 0255=max.)
	02	0000 ~ 0255	Send/read the RF gain level (0000=min. to 0255=max.)
	03	0000 ~ 0255	Send/read the squelch level (0000=min. to 0255=max.)
	05	0000 ~ 0255	Send/read the APF level (10 Hz steps) (0000=Pitch-550 Hz, 0128=Pitch, 0255=Pitch+550 Hz)
	06	0000 ~ 0255	Send/read the NR level (0000=0%, 0255=100%)
	07	0000 ~ 0255	Send/read inner [TWIN PBT] position (0000=max. CCW, 0128=center, 0255=max. CW)
	08	0000 ~ 0255	Send/read outer [TWIN PBT] position (0000=max. Counter Clockwise, 0128=center, 0255=max. Clockwise)
	09	0000 ~ 0255	Send/read CW pitch (5 Hz steps) (0000=300 Hz, 0128=600 Hz, 0255=900 Hz)
	0A	0000 ~ 0255	Send/read RF power (0000=min. to 0255=max.)
	0B	0000 ~ 0255	Send/read MIC gain (0000=min. to 0255=max.)
	0C	0000 ~ 0255	Send/read keying speed (0000=6 wpm to 0255=48 wpm)
	0D	0000 ~ 0255	Send/read Nothc filter setting (0000=max. Counter Clockwise, 0128=center, 0255=max. Clockwise)
	0E	0000 ~ 0255	Send/read the COMP level (0000=0 to 0255=10)
	0F	0000 ~ 0255	Send/read the Break-IN Delay setting (0000=2.0 d to 0255=13.0 d)
	12	0000 ~ 0255	Send/read NB level (0000=0% to 0255=100%)
	13	0000 ~ 0255	Send/read the DIGI-SEL shift amount (0000=min. to 0255=max.)
	14	0000 ~ 0255	Send/read DRIVE gain (0000=0% to 0255=100%)
	15	0000 ~ 0255	Send/read Monitor audio [MONI] level (0000=0% to 0255=100%)
	16	0000 ~ 0255	Send/read the VOX gain (0000=0% to 0255=100%)
17	0000 ~ 0255	Send/read the Anti VOX gain (0000=0% to 0255=100%)	
19	0000 ~ 0255	Send/read LCD backlight brightness (0000=0% to 0255=100%)	
15	01	00 or 01	Read noise or S-meter squelch status (00=Close, 01=Open)
	02	0000 to 0255	Read S-meter level (0000=S0, 0120=S9, 0241=S9+60 dB)
	05	00 or 01	Read various squelch (tone squelch, and so on) status (00=Close, 01=Open)

Remote control

◇ Command table (Continued)

Cmd.	Sub cmd.	Data	Description
15	07	00 or 01	Read the Overflow status (00=OVF indicator is OFF, 01=OVF indicator is ON)
	11	0000 ~ 0255	Read the PO meter level (0000=0% to 0143=50% to 212=100%)
	12	0000 ~ 0255	Read SWR meter level (0000=SWR1.0, 0048=SWR1.5, 0080=SWR2.0, 0120=SWR3.0)
	13	0000 ~ 0255	Read ALC meter level (0000=Min. to 0120=Max.)
	14	0000 ~ 0255	Read COMP meter level (0000=0 dB, 0130=15 dB, 0241=30 dB)
	15	0000 ~ 0255	Read Vd meter level (0000=0 V, 0151=10 V, 0211=16 V)
	16	0000 ~ 0255	Read Id meter level (0000=0A, 0077=10A, 0165=20A, 0241=30A)
16*	02	00	Preamp OFF
		01	Preamp 1 ON
		02	Preamp 2 ON
	12	01 ~ 03	Set the AGC time constant (01=FAST, 02=MID, 03=SLOW)
	22	00 or 01	Set the Noise blanker (00=OFF, 01=ON)
	32	00	Audio peak filter OFF
		01	Audio peak filter WIDE ON (320 Hz is selected when SHARP APF is set)
		02	Audio peak filter MID ON (160 Hz is selected when SHARP APF is set)
		03	Audio peak filter NAR ON (80 Hz is selected when SHARP APF is set)
	40	00 or 01	Set the Noise reduction (00=OFF, 01=ON)
	41	00 or 01	Set the Auto Notch function (00=OFF, 01=ON)
	42	00 or 01	Set the Repeater tone (00=OFF, 01=ON)
	43	00 or 01	Set the Tone squelch (00=OFF, 01=ON)
	44	00 or 01	Set the Speech compressor (00=OFF, 01=ON)
	45	00 or 01	Set the Monitor [MONI] function (00=OFF, 01=ON)
	46	00 or 01	Set the VOX function (00=OFF, 01=ON)
	47	00	BK-IN function OFF
		01	Semi BK-IN function ON
		02	Full BK-IN function ON
	48	00 or 01	Set the Manual Notch function (00=OFF, 01=ON)
	4E	00 or 01	Set the DIGI-SEL function (00=OFF, 01=ON)
	4F	00 or 01	Set the Twin peak filter (00=OFF, 01=ON) (Can be turned ON only when Mark and Shift are set to 2125 Hz and 170 Hz, respectively)
	50	00 or 01	Set the Dial lock function (00=OFF, 01=ON)
53*2	00 or 01	Set the ANT-RX I/O (00=OFF, 01=ON)	
56	00 or 01	Set the DSP IF filter type (00=SHARP, 01=SOFT)	
57	00 ~ 02	Set the Manual Notch width (00=WIDE, 01=MID, 02=NAR)	
58	00 ~ 02	Set the SSB transmit bandwidth (00=WIDE, 01=MID, 02=NAR) (One of following values is applied, depending on the "COMP" status (ON or OFF): WIDE (Command: 1A 05 0015), MID (Command: 1A 05 0016) or NAR (Command: 1A 05 0017))	
5E	00 or 01	MAIN/SUB Tracking function (00=OFF, 01=ON)	
65	00 or 01	Set the IP Plus function (00=OFF, 01=ON)	

Cmd.	Sub cmd.	Data	Description	
17*3		see p. 10	Send CW messages	
18	00		Turn OFF the transceiver	
	01*4		Turn ON the transceiver	
19	00		Read the transceiver ID	
1A*	00	see p. 11	Send/read memory contents	
	01	see p. 10	Send/read band stacking register contents	
	02*5	see p. 13	Send/read memory keyer contents	
	03	see p. 12	Send/read the selected IF filter width	
	04	see p. 12	Send/read the selected AGC time constant	
	05	0001	see p. 12	Tone Control > RX > Send/read SSB RX HPF/LPF settings
		0002	00 ~ 10	Tone Control > RX > Send/read SSB RX Tone (Bass) level (00=-5 to 10=+5)
		0003	00 ~ 10	Tone Control > RX > Send/read SSB RX Tone (Treble) level (00=-5 to 10=+5)
	0004	see p. 12	Tone Control > RX > Send/read AM RX HPF/LPF settings	
	0005	00 ~ 10	Tone Control > RX > Send/read AM RX Tone (Bass) level (00=-5 to 10=+5)	
	0006	00 ~ 10	Tone Control > RX > Send/read AM RX Tone (Treble) level (00=-5 to 10=+5)	
	0007	see p. 12	Tone Control > RX > Send/read FM RX HPF/LPF settings	
	0008	00 ~ 10	Tone Control > RX > Send/read FM RX Tone (Bass) level (00=-5 to 10=+5)	
	0009	00 ~ 10	Tone Control > RX > Send/read FM RX Tone (Treble) level (00=-5 to 10=+5)	
	0010	see p. 12	Tone Control > RX > Send/read CW RX HPF/LPF settings	
	0011	see p. 12	Tone Control > RX > Send/read RTTY RX HPF/LPF settings	
	0012	see p. 12	Tone Control > RX > Send/read PSK RX HPF/LPF settings	
	0013	00 ~ 10	Tone Control > TX > Send/read SSB TX Tone (Bass) level (00=-5 to 10=+5)	
	0014	00 ~ 10	Tone Control > TX > Send/read SSB TX Tone (Treble) level (00=-5 to 10=+5)	
	0015	see p. 12	Tone Control > TX > Send/read SSB TX bandwidth for wide	
	0016	see p. 12	Tone Control > TX > Send/read SSB TX bandwidth for mid	
	0017	see p. 12	Tone Control > TX > Send/read SSB TX bandwidth for narrow	
	0018	00 ~ 10	Tone Control > TX > Send/read AM TX Tone (Bass) level (00=-5 to 10=+5)	
	0019	00 ~ 10	Tone Control > TX > Send/read AM TX Tone (Treble) level (00=-5 to 10=+5)	
	0020	00 ~ 10	Tone Control > TX > Send/read FM TX Tone (Bass) level (00=-5 to 10=+5)	
0021	00 ~ 10	Tone Control > TX > Send/read FM TX Tone (Treble) level (00=-5 to 10=+5)		
0022	0000 ~ 0255	Function > Beep Level (0000=min. to 0255=max.)		
0023	00 or 01	Function > Beep Level Limit (00=OFF, 01=ON)		
0024	00 or 01	Function > Beep (Confirmation) (00=OFF, 01=ON)		
0025	00 or 01	Function > Band Edge Beep (00=OFF, 01=ON) (ON = Beep sounds with a default amateur band)		
	02	Function > Band Edge Beep (02=ON (User))		
	03	Function > Band Edge Beep (03=ON (User) & TX Limit)		

Remote control

◇ Command table (Continued)

Cmd.	Sub cmd.	Data	Description
1A*	05	0026	0050 ~ 0200 Function > Beep Sound (MAIN) (0050=500 Hz to 0200=2000 Hz)
		0027	0050 ~ 0200 Function > Beep Sound (SUB) (0050=500 Hz to 0200=2000 Hz)
		0028	00 ~ 02 Function > RF/SQL Control (00=Auto, 01=SQL, 02=RF+SQL)
		0029	00 ~ 05 Function > TX Delay > HF (00=OFF, 01=10 ms, 02=15 ms, 03=20 ms, 04=25 ms, 05=30 ms)
		0030	00 ~ 05 Function > TX Delay > 50M (00=OFF, 01=10 ms, 02=15 ms, 03=20 ms, 04=25 ms, 05=30 ms)
		0031	00 ~ 05 Function > Time-Out Timer (CI-V) (00=OFF, 01=3 min., 02=5 min., 03=10 min., 04=20 min., 05=30 min.)
		0032	00 or 01 Function > Quick Dualwatch (00=OFF, 01=ON)
		0033	00 or 01 Function > SPLIT > Quick SPLIT (00=OFF, 01=ON) (Setting the [SPLIT] key operation when it is held down for 1 second.)
		0034	00 or 01 Function > SPLIT > Display Keypad on Quick SPLIT (00=OFF, 01=ON)
		0035	see p. 12 Function > SPLIT > FM SPLIT Offset (HF)
		0036	see p. 12 Function > SPLIT > FM SPLIT Offset (50M)
		0037	00 or 01 Function > SPLIT > SPLIT LOCK (00=OFF, 01=ON)
		0038	00 or 01 Function > Tuner > PTT Start (00=OFF, 01=ON)
		0039	00 or 01 Function > Transverter Function (00=Auto, 01=ON)
		0040	see p. 12 Function > Transverter Offset
		0041	00 ~ 02 Function > RTTY Mark Frequency (00=1275 Hz, 01=1615 Hz, 02=2125 Hz)
		0042	00 ~ 02 Function > RTTY Shift Width (00=170 Hz, 01=200 Hz, 02=425 Hz)
		0043	00 or 01 Function > RTTY Keying Polarity (00=Normal, 01=Reverse)
		0044	00 ~ 02 Function > PSK Tone Frequency (00=1000 Hz, 01=1500 Hz, 02=2000 Hz)
		0045	00 or 01 Function > SPEECH > SPEECH Language (00=English, 01=Japanese)
		0046	00 or 01 Function > SPEECH > SPEECH Speed (00=Slow, 01=Fast)
		0047	00 or 01 Function > SPEECH > S-Level SPEECH (00=OFF, 01=ON)
		0048	00 or 01 Function > SPEECH > MODE SPEECH (00=OFF, 01=ON)
		0049	0000 ~ 0255 Function > SPEECH > SPEECH Level (0000=0% to 0255=100%)
		0050	00 or 01 Function > [SPEECH/LOCK] Switch (00=SPEECH/LOCK, 01=LOCK/SPEECH)
		0051	00 or 01 Function > Lock Function (00=MAIN DIAL, 01=ANEL)
		0052	00 or 01 Function > Memo Pad Quantity (00=5 ch, 01=10 ch)
		0053	00 to 02 Function > MAIN DIAL Auto TS (00=OFF, 01=Low, 02=High)
		0054	00 or 01 Function > MAIN DIAL Select (USB DIAL-SUB Only) (00=Main only, 01=Main/Sub)
		0055	00 or 01 Function > MAIN/SUB Tracking [MAIN/SUB] Switch (00=OFF, 01=ON)
		0056	00 or 01 Function > MIC Up/Down Speed (00=Slow, 01=Fast)
0057	00 or 01 Function > Quick RIT/ΔTX Clear (00=OFF, 01=ON)		
0058	00 ~ 02 Function > [NOTCH] Switch (SSB) (00=Auto, 01=Manual, 02=Auto/Manual)		
0059	00 ~ 02 Function > [NOTCH] Switch (AM) (00=Auto, 01=Manual, 02=Auto/Manual)		
0060	00 or 01 Function > FILTER Screen MAIN/SUB Select (00=Fix, 01=Auto (by FILTER, PBT Operation))		
0061	00 or 01 Function > SSB/CW Synchronous Tuning (00=OFF, 01=ON)		

Cmd.	Sub cmd.	Data	Description
1A*	05	0062	00 or 01 Function > CW Normal Side (00=LSB, 01=USB)
		0063	00 or 01 Function > Screen Keyboard Type (00=Ten-key, 01=Full Keyboard)
		0064	00 ~ 02 Function > Screen Full Keyboard Layout (00=English, 01=German, 02=French)
		0065	00 or 01 Function > Screen Capture [POWER] Switch (00=OFF, 01=ON)
		0066	00 or 01 Function > Screen Capture Keyboard [Print Screen] (00=OFF, 01=ON)
		0067	00 or 01 Function > Screen Capture Storage Media (00=SD Card, 01=USB flash drive)
		0068	00 or 01 Function > Screen Capture File Type (00=PNG, 01=BMP)
		0069	00 or 01 Function > Calibration Marker (00=OFF, 01=ON)
		0070	0000 ~ 0511 Function > REF Adjust (0000=0%, 0511=100%)
		0071	00 ~ 30 Connectors > Phones > Level (00=-15 dB to 30=+15 dB)
		0072	00 or 01 Connectors > Phones > L/R Mix (00=OFF, 01=ON)
		0073	00 or 01 Connectors > ACC AF/IF Output > AF/SQL Output Select (00=MAIN, 01=SUB)
		0074	00 or 01 Connectors > ACC AF/IF Output > Output Select (00=AF, 01=IF)
		0075	00 or 01 Connectors > ACC AF/IF Output > AF/IF XFC Output (SPLIT ON) (00=MAIN, 01=SUB)
		0076	0000 ~ 0255 Connectors > ACC AF/IF Output > AF Output Level (0000=0% to 0255=100%)
		0077	00 or 01 Connectors > ACC AF/IF Output > AF SQL (00=OFF (Open), 01=ON)
		0078	00 or 01 Connectors > ACC AF/IF Output > AF Beep/Speech... Output (00=OFF, 01=ON)
		0079	0000 ~ 0255 Connectors > ACC AF/IF Output > ACC IF Output Level (0000=0% to 0255=100%)
		0080	00 or 01 Connectors > USB AF/IF Output > Output Select (00=AF, 01=IF)
		0081	00 or 01 Connectors > USB AF/IF Output > AF/IF XFC Output (SPLIT ON) (00=MAIN, 01=SUB)
		0082	0000 ~ 0255 Connectors > USB AF/IF Output > AF Output Level (0000=0%, 0255=100%)
0083	00 or 01 Connectors > USB AF/IF Output > AF SQL (00=OFF (Open), 01=ON)		
0084	00 or 01 Connectors > USB AF/IF Output > AF Beep/Speech... Output (00=OFF, 01=ON)		
0085	0000 ~ 0255 Connectors > USB AF/IF Output > IF Output Level (0000=0%, 0255=100%)		
0086	00 or 01 Connectors > LAN AF/IF Output > Output Select (00=AF, 01=IF)		
0087	00 or 01 Connectors > LAN AF/IF Output > AF SQL (00=OFF (Open), 01=ON)		
0088	0000 ~ 0255 Connectors > MOD Input > ACC MOD Level (0000=0% to 0255=100%)		
0089	0000 ~ 0255 Connectors > MOD Input > USB MOD Level (0000=0% to 0255=100%)		
0090	0000 ~ 0255 Connectors > MOD Input > LAN MOD Level (0000=0% to 0255=100%)		
0091	00 ~ 05 Connectors > MOD Input > DATA OFF MOD (00=MIC, 01=ACC, 02=MIC,ACC, 03=USB, 04=MIC,USB, 05=LAN)		

Remote control

◇ Command table (Continued)

Cmd.	Sub cmd.	Data	Description
1A*	05	0092	00 ~ 05 Connectors > MOD Input > DATA1 MOD (00=MIC, 01=ACC, 02=MIC,ACC, 03=USB, 04=MIC,USB, 05=LAN)
		0093	00 ~ 05 Connectors > MOD Input > DATA2 MOD (00=MIC, 01=ACC, 02=MIC,ACC, 03=USB, 04=MIC,USB, 05=LAN)
		0094	00 ~ 05 Connectors > MOD Input > DATA3 MOD (00=MIC, 01=ACC, 02=MIC,ACC, 03=USB, 04=MIC,USB, 05=LAN)
		0095	00 ~ 04 Connectors > USB SEND/Keying > USB SEND (00=OFF, 01=USB1(A) DTR, 02=USB1(A) RTS, 03=USB1(B) DTR, 04=USB1(B) RTS) (You cannot select the same setting for USB keying (CW) or USB keying (RTTY).)
		0096	00 ~ 04 Connectors > USB SEND/Keying > USB Keying (CW) (00=OFF, 01=USB1(A) DTR, 02=USB1(A) RTS, 03=USB1(B) DTR, 04=USB1(B) RTS) (You cannot select the same setting for USB SEND.)
		0097	00 ~ 04 Connectors > USB SEND/Keying > USB Keying (RTTY) (00=OFF, 01=USB1(A) DTR, 02=USB1(A) RTS, 03=USB1(B) DTR, 04=USB1(B) RTS) (You cannot select the same setting for USB SEND.)
		0098	00 or 01 Connectors > External Keypad > VOICE (00=OFF, 01=ON)
		0099	00 or 01 Connectors > External Keypad > KEYER (00=OFF, 01=ON)
		0100	00 or 01 Connectors > External Keypad > RTTY (00=OFF, 01=ON)
		0101	00 or 01 Connectors > External Keypad > PSK (00=OFF, 01=ON)
		0102	00 or 01 Connectors > Keyboard/Mouse > Keyboard [F1] ~ [F8] (VOICE) (00=OFF, 01=ON)
		0103	00 or 01 Connectors > Keyboard/Mouse > Keyboard [F1] ~ [F8] (KEYER) (00=OFF, 01=ON)
		0104	00 ~ 10 Connectors > Keyboard/Mouse > Keyboard Type (00=English, 01=Japanese, 02=United Kingdom, 03=French, 04=French (Canadian), 05=German, 06=Portuguese, 07=Portuguese (Brazilian), 08=Spanish, 09=Spanish (Latin American), 10=Italian)
		0105	0010 ~ 0100 Connectors > Keyboard/Mouse > Keyboard Repeat Delay (0010=100 msec., 0100=1000 msec. (in 50 msec. steps))
		0106	00 ~ 31 Connectors > Keyboard/Mouse > Keyboard Repeat Rate (00=2.0 cps to 31=30.0 cps)
		0107	00 ~ 02 Connectors > Keyboard/Mouse > Mouse Pointer Speed (00=Slow, 01=Mid, 02=Fast)
		0108	00 or 01 Connectors > Keyboard/Mouse > Mouse Pointer Acceleration (00=OFF, 01=ON)
		0109	00 or 01 Connectors > USB DIAL > USB DIAL Select (00=Sub only, 01=Main/Sub)
		0110	00 ~ 02 Connectors > USB DIAL > USB DIAL Auto TS (00=OFF, 01=Low, 02=High)
0111	00 or 01 Connectors > USB DIAL > USB DIAL [TRANSMIT] Switch (00=Push to toggle, 01=Hold down to transmit)		
0112	00 or 01 Connectors > CI-V > CI-V Transceive (00=OFF, 01=ON)		
0113	0000 ~ 0223 Connectors > CI-V > CI-V USB/ LAN→REMOTE Transceive Address (0000=00h to 0223=DFh) (in Hexadecimal)		

Cmd.	Sub cmd.	Data	Description
1A*	05	0114	00 or 01 Connectors > CI-V > CI-V Output (for ANT) (00=OFF, 01=ON)
		0115	00 or 01 Connectors > CI-V > CI-V USB Port (00=Link to [REMOTE], 01=Unlink to [REMOTE])
		0116	00 or 01 Connectors > CI-V > CI-V USB Echo Back (00=OFF, 01=ON)
		0117	00 ~ 07 Connectors > External Meter > External Meter Output (MAIN) (00=Auto, 01=S (main), 02=Po, 03=SWR, 04=ALC, 05=COMP, 06=Vd, 07=Id)
		0118	00 ~ 07 Connectors > External Meter > External Meter Output (SUB) (00=Auto, 01=S (sub), 02=Po, 03=SWR, 04=ALC, 05=COMP, 06=Vd, 07=Id)
		0119	0000 ~ 0255 Connectors > External Meter > External Meter Level (MAIN) (0000=0% to 0255=100%)
		0120	0000 ~ 0255 Connectors > External Meter > External Meter Level (SUB) (0000=0% to 0255=100%)
		0121	00 ~ 03 Connectors > Decode Baud Rate (00=4800 bps, 01=9600 bps, 02=19200 bps, 03=38400 bps)
		0122	00 or 01 Connectors > SEND Relay Type (00=Reed, 01=MOS-FET)
		0123	00 ~ 02 Connectors > ACC BAND Voltage Output (00=MAIN, 01=SUB, 02=TX)
		0124	00 or 01 Connectors > MIC Input DC Bias (00=OFF, 01=ON)
		0125	00 or 01 Connectors > REF IN (00=IN, 01=OFF)
		0126	00 or 01 Network > DHCP (valid after restart) (00=OFF, 01=ON)
		0127	0000000000 000001 ~ 0255025502 550254 550254 Network > IP Address (valid after restart) (0000000000000001=0.0.0.1 to 0255025502 550254=255.255.255.254) (Valid when the DHCP (valid after restart) is set to OFF.)
		0128	0000000000 000001 ~ 0255025502 550254 Network > DHCP (valid after restart) Read the IP address set by the DHCP server (0000000000000001=0.0.0.1 to 0255025502 550254=255.255.255.254) (When the DHCP setting (valid after restart) is set to OFF, the manually set IP address (static IP address) is returned.)
		0129	01 ~ 30 Network > Subnet Mask (valid after restart) (01=128.0.0.0 (1 bit) to 30=255.255.255.252 (30 bit)) (Valid when the DHCP (valid after restart) setting is set to OFF.)
		0130	0000000000 000001 ~ 0255025502 550254, FF Network > Default Gateway (valid after restart) (0000000000000001=0.0.0.1 to 0255025502 550254=255.255.255.254, FF=Blank) (Valid when the DHCP (valid after restart) setting is set to OFF.)
		0131	0000000000 000001 ~ 0255025502 550254, FF Network > Primary DNS Server (valid after restart) (0000000000000001=0.0.0.1 to 0255025502 550254=255.255.255.254, FF=Blank) (Valid when the DHCP (valid after restart) setting is set to OFF.)
		0132	0000000000 000001 ~ 0255025502 550254, FF Network > 2nd DNS Server (valid after restart) (0000000000000001=0.0.0.1 to 0255025502 550254=255.255.255.254, FF=Blank) (Valid when the DHCP (valid after restart) setting is set to OFF.)
0133	see p. 11 Network > Network Name (Up to 15 characters)		
0134	00 or 01 Network > Network Control (valid after restart) (00=OFF, 01=ON)		
0135	00 or 01 Network > Power OFF Setting (for Remote Control) (00=Shutdown only, 01=Standby/Shutdown)		
0136	000001 ~ 065535 Network > Control Port (UDP) (valid after restart) (000001=1 to 065535=65535)		

Remote control

◇ Command table (Continued)

Cmd.	Sub cmd.	Data	Description
1A*	05	0137	000001 ~ 065535 Network > Serial Port (UDP) (valid after restart) (000001=1 to 065535=65535)
		0138	000001 ~ 065535 Network > Audio Port (UDP) (valid after restart) (000001=1 to 065535=65535)
		0139	00 or 01 Network > Internet Access Line (valid after restart) (00=FTTH (Fiber To The Home), 01=ADSL/CATV)
		0140	see p. 11 Network > Network Radio Name (Up to 16 characters)
		0141	0000 ~ 0255 Display > LCD Backlight (0000=0% to 0255=100%)
		0142	0000 ~ 0255 Display > LED Bright (0000=0% to 0255=100%)
		0143	00 or 01 Display > Display Type (00=A, 01=B)
		0144	00 or 01 Display > Display Font (00=Basic, 01=Round)
		0145	00 ~ 02 Display > Meter Response (Standard, Edgewise) (00=Slow, 01=Mid, 02=Fast)
		0146	00 ~ 02 Display > Meter Type (Normal Screen) (00=Standard, 01=Edgewise, 02=Bar)
		0147	00 or 01 Display > Meter Type (Expand Screen) (00=Edgewise, 01=Bar)
		0148	00 or 01 Display > Meter Peak Hold (Bar) (00=OFF, 01=ON)
		0149	00 or 01 Display > Memory Name (00=OFF, 01=ON)
		0150	00 or 01 Display > APF-Width Popup (APF OFF→ON) (00=OFF, 01=ON)
		0151	00 ~ 03 Display > Screen Saver (00=OFF, 01=15 minutes, 02=30 minutes, 03=60 minutes)
		0152	00 or 01 Display > External Display (00=OFF, 01=ON)
		0153	00 or 01 Display > External Display Resolution (00=800x480, 01=800x600)
		0154	00 or 01 Display > Opening Message (00=OFF, 01=ON)
		0155	see p. 11 Display > My Call (Up to 10 characters)
		0156	00 or 01 Display > Power ON Check (00=OFF, 01=ON)
		0157	00 or 01 Display > Display Language (00=English, 01=Japanese)
		0158	20000101 ~ 20991231 Time Set > Date/Time > Date (20000101=2000/01/01 to 20991231=2099/12/31)
		0159	0000 ~ 2359 Time Set > Date/Time > Time (0000=00:00 to 2359=23:59)
		0160	00 or 01 Time Set > Date/Time > NTP Function (00=OFF, 01=ON)
		0161	see p. 11 Time Set > Date/Time > NTP Server Address
		0162	see p. 13 Time Set > UTC Offset
		0163	00 or 01 Time Set > CLOCK2 Function (00=OFF, 01=ON)
		0164	see p. 13 Time Set > CLOCK2 UTC Offset
		0165	see p. 11 Time Set > CLOCK2 Name (Up to 3 characters)
		0166	00 or 01 SCOPE > Scope during Tx (CENTER TYPE) (00=OFF, 01=ON)
		0167	00 ~ 02 SCOPE > Max Hold (00=OFF, 01=10s Hold, 02=ON)
		0168	00 ~ 02 SCOPE > CENTER Type Display (00=Filter center, 01=Carrier point center, 02=Carrier point center (Abs. Freq.))
		0169	00 or 01 SCOPE > Marker Position (Fix Type) (00=Filter center, 01=Carrier point)
0170	00 ~ 03 SCOPE > Averaging (00=OFF, 01=2, 02=3, 03=4)		
0171	00 or 01 SCOPE > Waveform Type (00=Fill, 01=Fill+Line)		
0172	see p. 12 SCOPE > Waveform Color (Current)		
0173	see p. 12 SCOPE > Waveform Color (Line)		
0174	see p. 12 SCOPE > Waveform Color (Max Hold)		
0175	00 or 01 SCOPE > Waterfall Display (00=OFF, 01=ON)		

Cmd.	Sub cmd.	Data	Description
1A*	05	0176	00 ~ 02 SCOPE > Waterfall Speed (00=Slow, 01=Mid, 02=Fast)
		0177	00 ~ 02 SCOPE > Waterfall Size (Expand Screen) (00=Small, 01=Mid, 02=Large)
		0178	00 ~ 09 SCOPE > Waterfall Peak Color Level (00=Grid 1 to 09=Grid 10)
		0179	00 or 01 SCOPE > Waterfall Marker Auto-hide (00=OFF, 01=ON)
		0180	00 or 01 SCOPE > Dual Scope Type (00=Over/Under, 01=Side by Side)
		0181	00 or 01 SCOPE > Dual Scope Auto Select (00=OFF, 01=ON)
		0182	see p. 12 SCOPE > Fixed Edges > 0.03 – 1.60 No.1
		0183	see p. 12 SCOPE > Fixed Edges > 0.03 – 1.60 No.2
		0184	see p. 12 SCOPE > Fixed Edges > 0.03 – 1.60 No.3
		0185	see p. 12 SCOPE > Fixed Edges > 1.60 – 2.00 No.1
		0186	see p. 12 SCOPE > Fixed Edges > 1.60 – 2.00 No.2
		0187	see p. 12 SCOPE > Fixed Edges > 1.60 – 2.00 No.3
		0188	see p. 12 SCOPE > Fixed Edges > 2.00 – 6.00 No.1
		0189	see p. 12 SCOPE > Fixed Edges > 2.00 – 6.00 No.2
		0190	see p. 12 SCOPE > Fixed Edges > 2.00 – 6.00 No.3
		0191	see p. 12 SCOPE > Fixed Edges > 6.00 – 8.00 No.1
		0192	see p. 12 SCOPE > Fixed Edges > 6.00 – 8.00 No.2
		0193	see p. 12 SCOPE > Fixed Edges > 6.00 – 8.00 No.3
		0194	see p. 12 SCOPE > Fixed Edges > 8.00 – 11.00 No.1
		0195	see p. 12 SCOPE > Fixed Edges > 8.00 – 11.00 No.2
		0196	see p. 12 SCOPE > Fixed Edges > 8.00 – 11.00 No.3
		0197	see p. 12 SCOPE > Fixed Edges > 11.00 – 15.00 No.1
		0198	see p. 12 SCOPE > Fixed Edges > 11.00 – 15.00 No.2
		0199	see p. 12 SCOPE > Fixed Edges > 11.00 – 15.00 No.3
		0200	see p. 12 SCOPE > Fixed Edges > 15.00 – 20.00 No.1
		0201	see p. 12 SCOPE > Fixed Edges > 15.00 – 20.00 No.2
		0202	see p. 12 SCOPE > Fixed Edges > 15.00 – 20.00 No.3
		0203	see p. 12 SCOPE > Fixed Edges > 20.00 – 22.00 No.1
		0204	see p. 12 SCOPE > Fixed Edges > 20.00 – 22.00 No.2
		0205	see p. 12 SCOPE > Fixed Edges > 20.00 – 22.00 No.3
		0206	see p. 12 SCOPE > Fixed Edges > 22.00 – 26.00 No.1
		0207	see p. 12 SCOPE > Fixed Edges > 22.00 – 26.00 No.2
		0208	see p. 12 SCOPE > Fixed Edges > 22.00 – 26.00 No.3
0209	see p. 12 SCOPE > Fixed Edges > 26.00 – 30.00 No.1		
0210	see p. 12 SCOPE > Fixed Edges > 26.00 – 30.00 No.2		
0211	see p. 12 SCOPE > Fixed Edges > 26.00 – 30.00 No.3		
0212	see p. 12 SCOPE > Fixed Edges > 30.00 – 45.00 No.1		
0213	see p. 12 SCOPE > Fixed Edges > 30.00 – 45.00 No.2		
0214	see p. 12 SCOPE > Fixed Edges > 30.00 – 45.00 No.3		
0215	see p. 12 SCOPE > Fixed Edges > 45.00 – 60.00 No.1		
0216	see p. 12 SCOPE > Fixed Edges > 45.00 – 60.00 No.2		
0217	see p. 12 SCOPE > Fixed Edges > 45.00 – 60.00 No.3		
0218	00 or 01 AUDIO SCOPE SET > FFT Scope Waveform Type (00=Line, 01=Fill)		
0219	see p. 12 AUDIO SCOPE SET > FFT Scope Waveform Color		
0220	00 or 01 AUDIO SCOPE SET > FFT Scope Waterfall Display (00=OFF, 01=ON)		
0221	see p. 12 AUDIO SCOPE SET > Oscilloscope Waveform Color		
0222	00 ~ 04 KEYER 001 > Number Style (00=Normal, 01=190→ANT, 02=190→ANT, 03=90→NO, 04=90→NT)		
0223	01 ~ 08 KEYER 001 > Count Up Trigger (01=M1 to 08=M8)		
0224	0001 ~ 9999 KEYER 001 > Present Number (0001=1 to 9999=9999)		
0225	0000 ~ 0255 CW-KEY SET > Side Tone Level (0000=0% to 0255=100%)		
0226	00 or 01 CW-KEY SET > Side Tone Level Limit (00=OFF, 01=ON)		
0227	01 ~ 60 CW-KEY SET > Keyer Repeat time (01=1 sec. to 60=60 sec.)		
0228	28 ~ 45 CW-KEY SET > Dot/Dash Ratio (28=1:1.2.8 to 45=1:1.4.5; 0.1 steps)		

Remote control

◇ Command table (Continued)

Cmd.	Sub cmd.	Data	Description
1A*	05	0229	00 ~ 03 CW-KEY SET > Rise Time (00=2 msec., 01=4 msec., 02=6 msec., 03=8 msec.)
		0230	00 or 01 CW-KEY SET > Paddle Polarity (00=Normal, 01=Reverse)
		0231	00 ~ 02 CW-KEY SET > Key Type (00=Straight, 01=Bug, 02=Paddle)
		0232	00 or 01 CW-KEY SET > MIC Up/Down Keyer (00=OFF, 01=ON)
		0233	00 ~ 03 RTTY DECODE SET > FFT Scope Averaging (00=OFF, 01=2, 02=3, 03=4)
		0234	see p. 12 RTTY DECODE SET > FFT Scope Waveform Color
		0235	00 or 01 RTTY DECODE SET > Decode USOS (00=OFF, 01=ON)
		0236	00 or 01 RTTY DECODE SET > Decode New Line Code (00=CR, LF, CR+LF, 01=CR+LF)
		0237	00 ~ 02 RTTY DECODE SET > Diddle (00=OFF, 01=BLANK, 02=LTRS)
		0238	00 or 01 RTTY DECODE SET > TX USOS (00=OFF, 01=ON)
		0239	00 or 01 RTTY DECODE SET > Auto CR+LF by TX (00=OFF, 01=ON)
		0240	00 or 01 RTTY DECODE SET > Time Stamp (00=OFF, 01=ON)
		0241	00 or 01 RTTY DECODE SET > Time Stamp (Time) (00=Local, 01="CLOCK2 UTC Offset" setting)
		0242	00 or 01 RTTY DECODE SET > Time Stamp (Frequency) (00=OFF, 01=ON)
		0243	see p. 12 RTTY DECODE SET > Font Color (Receive)
		0244	see p. 12 RTTY DECODE SET > Font Color (Transmit)
		0245	see p. 12 RTTY DECODE SET > Font Color (Time Stamp)
		0246	see p. 12 RTTY DECODE SET > Font Color (TX Buffer)
		0247	00 or 01 RTTY DECODE LOG > Decode Log (00=OFF, 01=ON)
		0248	00 or 01 RTTY DECODE LOG > Log Set > File Type (00=Text, 01=HTML)
		0249	00 ~ 03 PSK DECODE SET > FFT Scope Averaging (00=OFF, 01=2, 02=3, 03=4)
		0250	see p. 12 PSK DECODE SET > FFT Scope Waveform Color
		0251	00 or 01 PSK DECODE SET > AFC Range (00=±8 Hz, 01=±15 Hz)
		0252	00 or 01 PSK DECODE SET > Time Stamp (00=OFF, 01=ON)
		0253	00 or 01 PSK DECODE SET > Time Stamp (Time) (00=Local, 01="CLOCK2 UTC Offset" setting)
		0254	00 or 01 PSK DECODE SET > Time Stamp (Frequency) (00=OFF, 01=ON)
		0255	see p. 12 PSK DECODE SET > Font Color (Receive)
		0256	see p. 12 PSK DECODE SET > Font Color (Transmit)
		0257	see p. 12 PSK DECODE SET > Font Color (Time Stamp)
		0258	see p. 12 PSK DECODE SET > Font Color (TX Buffer)
		0259	00 or 01 PSK DECODE LOG > Decode Log (00=OFF, 01=ON)
		0260	00 or 01 PSK DECODE LOG > Log Set > File Type (00=Text, 01=HTML)
		0261	00 or 01 SCAN SET > SCAN Speed (00=Slow, 01=Fast)
		0262	00 or 01 SCAN SET > SCAN Resume (00=OFF, 01=ON)
		0263	0000 ~ 0255 VOICE TX > TX LEVEL (0000=0%, 0255=100%)
		0264	00 or 01 VOICE TX SET > Auto Monitor (00=OFF, 01=ON)
		0265	01 ~ 15 VOICE TX SET > Repeat Time (01=1 sec. to 15=15 sec.)
		0266	00 or 01 Recorder Set > REC Mode (00=TX&RX, 01=RX Only)
		0267	00 or 01 Recorder Set > TX REC Audio (00=Direct, 01=Monitor)
		0268	00 or 01 Recorder Set > RX REC Condition (00=Always, 01=Squelch Auto)
		0269	00 or 01 Recorder Set > File Split (00=OFF, 01=ON)

Cmd.	Sub cmd.	Data	Description	
1A*	05	0270	00 or 01 Recorder Set > PTT Auto REC (00=OFF, 01=ON)	
		0271	00 ~ 03 Recorder Set > PRE-REC for PTT Auto REC (00=OFF, 01=5 sec., 02=10 sec., 03=15 sec.)	
		0272	00 ~ 03 Player Set > Skip Time (00=3 sec., 01=5 sec., 02=10 sec., 03=30 sec.)	
		0273	05 ~ 30 Instant Replay Set > REC Time (05=5 sec., to 30=30 sec.)	
		0274	03 ~ 10 Instant Replay Set > Play Time (03=3 sec., to 10=10 sec.)	
		0275	00 or 01 TYPE SET > RX-ANT Connectors (00=Connect an receive antenna, 01=Connect an external device)	
		0276	see p. 13 ANTENNA MEMORY (0.03 MHz to 1.60 MHz)	
		0277	see p. 13 ANTENNA MEMORY (1.60 MHz to 2.00 MHz)	
		0278	see p. 13 ANTENNA MEMORY (2.00 MHz to 6.00 MHz)	
		0279	see p. 13 ANTENNA MEMORY (6.00 MHz to 8.00 MHz)	
		0280	see p. 13 ANTENNA MEMORY (8.00 MHz to 11.00 MHz)	
		0281	see p. 13 ANTENNA MEMORY (11.00 MHz to 15.00 MHz)	
		0282	see p. 13 ANTENNA MEMORY (15.00 MHz to 20.00 MHz)	
		0283	see p. 13 ANTENNA MEMORY (20.00 MHz to 22.00 MHz)	
		0284	see p. 13 ANTENNA MEMORY (22.00 MHz to 26.00 MHz)	
		0285	see p. 13 ANTENNA MEMORY (26.00 MHz to 30.00 MHz)	
		0286	see p. 13 ANTENNA MEMORY (30.00 MHz to 45.00 MHz)	
		0287	see p. 13 ANTENNA MEMORY (45.00 MHz to 60.00 MHz)	
		0288	00 or 01 Temporary memory (TEMP-M) function (00=OFF, 01=ON)	
		0289	00 ~ 02 Send the Antenna selection mode ([ANT] SW) (00=OFF, 01=Manual, 02=Auto)	
		0290	00 ~ 09 NB depth (00=1 to 09=10)	
		0291	0000 ~ 0255 NB width (0000=1 to 0255=100)	
		0292	00 ~ 20 VOX delay (00=0.0 sec. to 20=2.0 sec.; 0.1 sec steps)	
		0293	00 ~ 03 VOX voice delay (00=OFF, 01=Short, 02=Mid, 03=Long)	
		0294	00 or 01 APF > TYPE (00=SHARP, 01=SOFT)	
		0295	00 ~ 06 APF > AF LEVEL (00=0 dB to 06=6 dB)	
			06	see p. 12 DATA mode with filter set
			07	00 or 01 NTP server access (00=Terminate, 01=Initiate)
			08*5	00 ~ 02 Read NTP server access result (00=Accessing, 01=Succeeded, 02=Failed)
	09	00 or 01 AF Mute (00=OFF, 01=ON)		
1B*	00	see p. 13 Repeater tone frequency		
	01	see p. 13 TSQ L tone frequency		
1C	00*	00 or 01 Transceiver's status (00=RX, 01=TX) *When "CI-V Output (for ANT)" (Command: 1C 04) is set to "ON," automatically outputs when changed.		
	01*	00 ~ 02 Antenna tuner (00=OFF, 01=ON, 02=Tune)		
	02*	00 or 01 Transmit frequency monitor (XFC) (00=OFF, 01=ON)		
	03	see p. 10 Read transmit frequency (When "CI-V Output (for ANT)" (Command: 1C 04) is set to "ON," automatically outputs when changed.)		
	04*	00 or 01 CI-V Output (for ANT) (00=OFF, 01=ON)		

Remote control

◇ Command table (Continued)

Cmd.	Sub cmd.	Data	Description
1E	00		Read number of available TX frequency band
	01	see p. 10	Read TX band edge frequencies
	02		Read number of user-set TX frequency band
	03*	see p. 10	Send/read user-set TX band edge frequencies
21*	00	see p. 13	RIT frequency
	01	00 or 01	RIT setting (00=OFF, 01=ON)
	02	00 or 01	ΔTX setting (00=OFF, 01=ON)
25*		see p. 13	Main or sub band frequency
26*		see p. 13	Send/read the operating mode and filter setting (for both Main and Sub bands)
27*	00	see p. 14	Read the Scope waveform data (Only when "Scope ON/OFF status" (Command: 27 10) and "Scope data output" (Command: 27 20) are set to "ON," outputs the waveform data to the controller.)
	10	00 or 01	Scope ON/OFF status (00=OFF, 01=ON)
	11*7	00 or 01	Scope wave data output (00=OFF, 01=ON)
	12	00 or 01	Main or Sub scope setting (00=Main, 01=Sub)
	13	00 or 01	Single/Dual scope setting (00=Single, 01=Dual)
	14	see p. 14	Scope Center mode or Fixed mode setting
	15	see p. 14	Span setting in the Center mode Scope
	16	see p. 14	Edge number setting in the Fixed mode Scope
	17	see p. 14	Scope hold function ON or OFF
	19	see p. 15	Scope Reference level setting
	1A	see p. 15	Sweep speed setting
	1B	00 or 01	SCOPE > Scope during Tx (CENTER TYPE) (00=OFF, 01=ON)
	1C	00 ~ 02	SCOPE > CENTER Type Display (00=Filter center, 01=Carrier point center, 02=Carrier point center (Abs. Freq.))
	1D	see p. 15	Scope VBW setting
	1E	see p. 15	Scope Fixed edge frequencies
	1F	see p. 15	Scope RBW setting
28	00	00 ~ 08	Voice TX Memory (00=Stop, 01=T1 to 08=T8)

*(Asterisk) Send/read data

*1 If the Antenna Type is set to "RX-I/O," command "01 (RX ANT ON)" is invalid and "00 (RX ANT OFF)" is always returned.

*2 If the Antenna Type is set to "RX-ANT," command "01 (ON)" is invalid and "00 (OFF)" is always returned.

*3 In the CW mode, if the [TRANSMIT] or an external TX switch is ON, or the Break-in function is ON, a message will be transmitted as CW code when you send it from your PC.

*4 When sending the power ON command (18 01), you need to repeatedly send "FE" before the standard format. The following is the approximate number of needed repetitions.

- 115200 bps: 150 "FE"s
- 57600 bps: 75 "FE"s
- 38400 bps: 50 "FE"s
- 19200 bps: 25 "FE"s
- 9600 bps: 13 "FE"s
- 4800 bps: 7 "FE"s

Example: When using 4800 bps

Preamble		7610's address		Controller's address		Command		Sub command		Post amble					
F	E	F	E	F	E	9	8	E	0	1	8	0	1	F	D

×7

*5 Read only data

*6 To insert a counter, first clear the other channel's counter.

*7 When you use the [USB 1] port, you need to select "Unlink from [REMOTE]" in the "CI-V USB port" item, and you need to select "115200" in the "CI-V Baud Rate" item.

MENU » **SET > Connectors > CI-V**

You can use the [LAN] port, regardless of those settings. You cannot use the [REMOTE] terminal, regardless of those settings.

Remote control

◆ Command formats

• Operating frequency

Command: 00, 03, 05, 1C 03

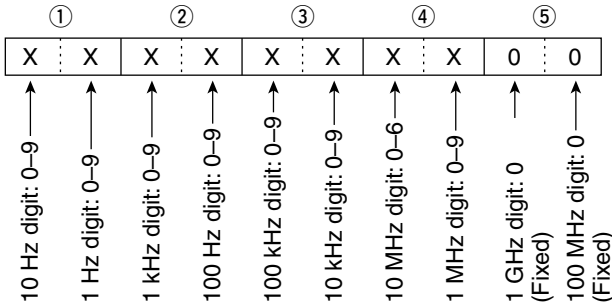

• Operating mode

Command: 01, 04, 06

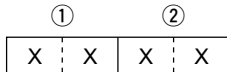

① Receiving mode		② Filter setting
00:LSB	05:FM	01:FIL1
01:USB	07:CW-R	02:FIL2
02:AM	08:RTTY-R	03:FIL3
03:CW	12:PSK	—
04:RTTY	17:PSK-R	—

① Filter setting (②) can be skipped with command 01 and 06. In that case, "FIL1" is selected with command 01 and the default filter setting of the receiving mode is automatically selected with command 06.

• Codes for CW message contents

Command: 17 Up to 30 characters

To send CW messages, use the following character codes.

Character	ASCII code	Character	ASCII code
0-9	30-39	'	27
A-Z	41-5A	(28
a-z	61-7A)	29
/	2F	=	3D
?	3F	+	2B
.	2E	"	22
-	2D	@	40
,	2C	Space	20
:	3A		

① "FF" stops sending CW messages.

① "^" is used to transmit a string of characters with no inter-character space.

• Band edge frequency settings

Command: 02*, 1E 01, 1E 03

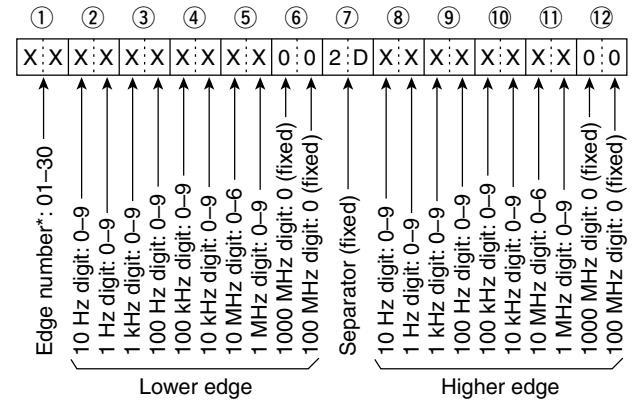

*When obtaining the edge number (by command "02"), the edge number (①) is not returned.

• Band stacking register

Command: 1A 01

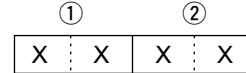

① Frequency band codes

Code	Freq. band	Frequency range (unit: MHz)
01	1.8	1.800000 ~ 1.999999
02	3.5	3.400000 ~ 4.099999
03	7	6.900000 ~ 7.499999
04	10	9.900000 ~ 10.499999
05	14	13.900000 ~ 14.499999
06	18	17.900000 ~ 18.499999
07	21	20.900000 ~ 21.499999
08	24	24.400000 ~ 25.099999
09	28	28.000000 ~ 29.999999
10	50	50.000000 ~ 54.000000
11	GENE	Other than above

② Register codes

Code	Registered number
01	1 (latest)
02	2
03	3 (oldest)

For example, when sending/reading the oldest contents in the 21 MHz band, the code "0703" is used.

Remote control

◇ Command formats (Continued)

• Memory content

Command: 1A 00

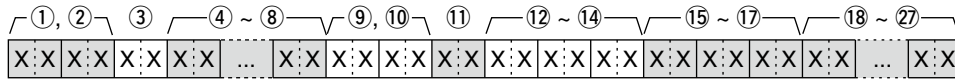

①, ② Memory channel numbers

0001 ~ 0099: Memory channel 01 to 99
 0100: Programmed scan edge P1
 0101: Programmed scan edge P2

③ Select memory setting

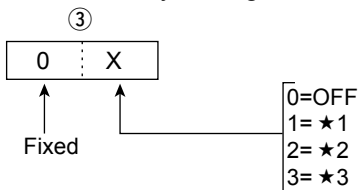

① Set 0 for P1 and P2.

④ ~ ⑧ Operating frequency setting

See “• Operating frequency.”

⑨, ⑩ Operating mode setting

See “• Operating mode.”

⑪ Data mode and tone type settings

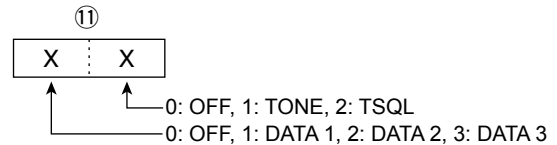

⑫ ~ ⑭ Repeater tone frequency setting

⑮ ~ ⑰ Tone squelch frequency setting

See “• Repeater tone/tone squelch settings.”

⑱ ~ ⑳ Memory name settings

Up to 10 characters.
 See “• Codes for character entries.”

To clear the memory channel contents on 1A 00:

- ①, ②: Memory channel (0001~0099)
- ③: “FF”
- ④: None

• Codes for character entries

Command: 1A 00, 1A 05 0133, 0140, 0155, 0161, 0165

- Character codes— Letters and Numbers

Character	ASCII code	Character	ASCII code
A–Z	41–5A	a–z	61–7A
0–9	30–39		

- Character codes— Symbols

Character	ASCII code	Character	ASCII code
!	21	#	23
\$	24	%	25
&	26	\	5C
?	3F	”	22
,	27	`	60
^	5E	+	2B
-	2D	*	2A
/	2F	.	2E
,	2C	:	3A
;	3B	=	3D
<	3C	>	3E
(28)	29
[5B]	5D
{	7B	}	7D
	7C	_	5F
~	7E	@	40

Command	Set item/selectable characters
1A 00	Memory name All characters are usable.
1A 05 0133	Network > Network Name (up to 15 characters)
0140	Network > Network Radio Name (up to 16 characters)
0155	Display > My Call (up to 10 characters)
0161	Time Set > Date/Time > NTP Server Address
0165	Time Set > CLOCK2 Name (up to 3 characters)

Remote control

◇ Command formats (Continued)

• Data mode with filter width settings

Command: 1A 06

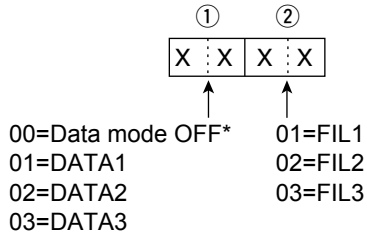

*When 00 is set, also set 00 to ②

• RX HPF/LPF setting for each operating mode

Command: 1A 05 0001, 05 0004, 05 0007,
 05 0010, 05 0011, 05 0012

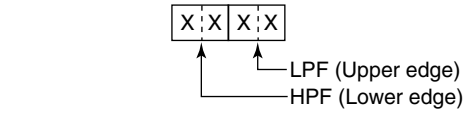

HPF LPF
 00: Through 05 ~ 24: 500~2400 Hz
 01 ~ 20: 100 ~ 2000 Hz 25: Through

*The value of the HPF should be smaller than the LPF.

• IF filter width settings

Command: 1A 03

Mode	Data	Steps
SSB/CW/ RTTY/PSK	0 to 9	50 ~ 500 Hz (50 Hz)
SSB/CW/ PSK	10 to 40	600 Hz ~ 3.6 kHz (100 Hz)
RTTY	10 to 31	600 ~ 2.7 kHz (100 Hz)
AM	0 to 49	200 Hz ~ 10.0 kHz (200 Hz)

• AGC time constant settings

Command: 1A 04

Data	AGC time constant (sec.)	
	SSB/CW/RTTY/PSK	AM
0	OFF	OFF
1	0.1	0.3
2	0.2	0.5
3	0.3	0.8
4	0.5	1.2
5	0.8	1.6
6	1.2	2.0
7	1.6	2.5
8	2.0	3.0
9	2.5	4.0
10	3.0	5.0
11	4.0	6.0
12	5.0	7.0
13	6.0	8.0

• SSB transmission passband width settings

Command: 1A 05 0015, 05 0016, 05 0017

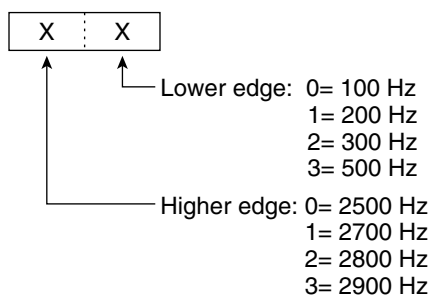

• Bandscope edge frequency settings

Command: 1A 05 0182 ~ 05 0217

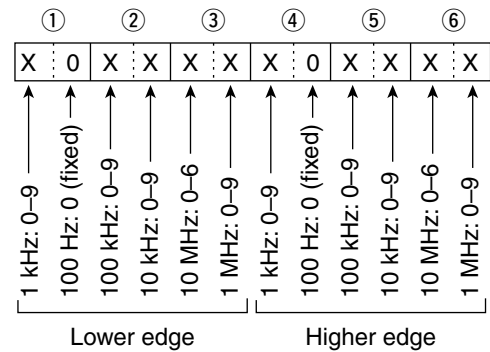

• Color settings

Command: 1A 05 0172, 0173, 0174, 0219, 0221,
 0234, 0243, 0244, 0245, 0246,
 0250, 0255, 0256, 0257, 0258

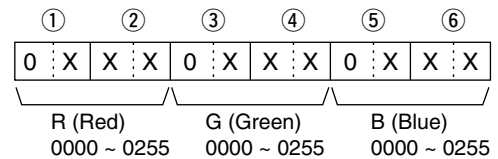

• Offset frequency settings

Command: 1A 05 0035, 0036, 0040

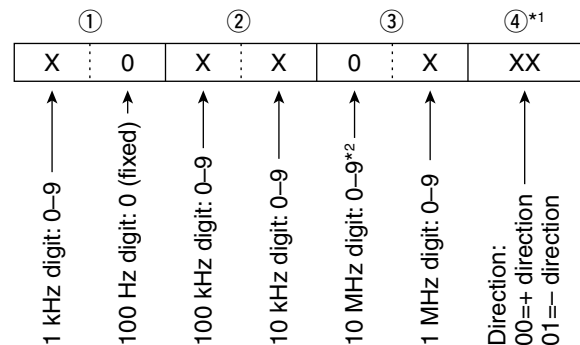

*1 No need to enter for transverter offset frequency setting.

*2 Transverter offset only. Fix to '0' for split offset setting.

Remote control

◇ Command formats (Continued)

• Memory key character entries

Command: 1A 02

- Character codes

Character	ASCII code	Description
0 ~ 9	30 ~ 39	Numbers
A ~ Z	41 ~ 5A	Letters
space	20	Word space
/	2F	Symbol
?	3F	Symbol
,	2C	Symbol
.	2E	Symbol
@	40	Symbol
^	5E	Example: to send \bar{B} , enter ^4254
*	2A	Inserts contest number (can be used for 1 channel only)

• Memory key content

Command: 1A 02

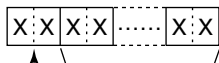

② ~ ⑦: Text data

①: Channel data

- 01: M1 05: M5
- 02: M2 06: M6
- 03: M3 07: M7
- 04: M4 08: M8

• UTC Offset setting

Command: 1A 05 0162, 0164

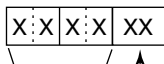

Shift direction
00: + (plus)
01: - (minus)
Offset time
0000 ~ 1400

• Antenna memory settings

Command: 1A 05 0276 to 0287

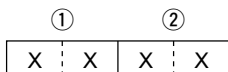

① ANT1/ANT2	② RX-ANT or RX-I/O
00: ANT 1	00: RX-ANT or RX-I/O OFF
01: ANT 2	00: RX-ANT or RX-I/O ON*

*Depending on the selected antenna type.

• RIT frequency settings

Command: 21 00

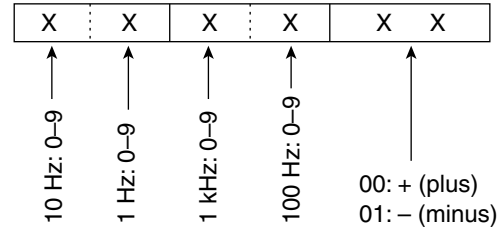

• Repeater tone/tone squelch frequency settings

Command: 1B 00, 1B 01

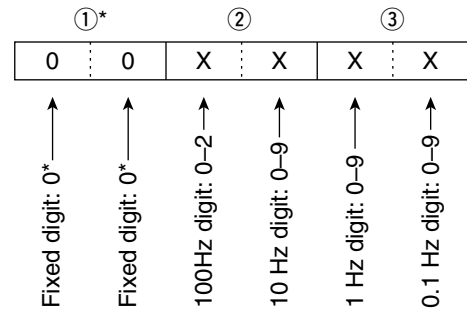

*Not necessary when setting a frequency.

• Main or Sub band's frequency settings

Command: 25

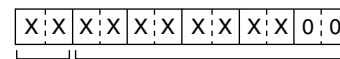

00: MAIN Operating frequency data (See p. 10)
01: SUB

• Main or Sub band's operating mode and filter settings

Command: 26

Both data and filter settings can be skipped. In that case, "DATA OFF" and the default filter setting of the operating mode are automatically selected.

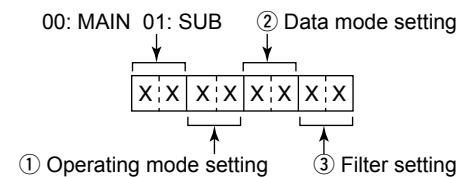

① Operating mode	② Data mode setting	③ Filter setting
00: LSB	05: FM	00: Data mode OFF
01: USB	07: CW-R	01: Data mode 1 (D1)
02: AM	08: RTTY-R	02: Data mode 2 (D2)
03: CW	12: PSK	03: Data mode 3 (D3)
04: RTTY	08: PSK-R	

Remote control

◇ Command formats (Continued)

• Scope waveform data

Command: 27 00

Outputs the waveform data to the controller

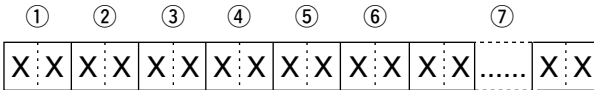

- ① Main or Sub scope data
 - 00=Main scope, 01=Sub scope
- ② Order of division data (Current)
- ③ Division number (01 or 15)

When data is sent to the controller through the LAN port, all data is sent together. However, when the data is sent through the USB port, the data is divided by 15 and sent in sequential order.

	Division number	Data length	
LAN	01	704	
USB	15	1st data	15
		2nd or later data	53
		15th data	42

The 1st data sends only the wave information (① ~ ⑥) without the waveform data (⑦).
The 2nd or later data sends the minimum wave information (① ~ ③) with waveform data (⑦).

- ④ Center or Fixed mode data
 - 00 = Center mode scope,
 - 01 = Fixed mode scope
- ⑤ Waveform information

The waveform information is different between Center mode and fixed mode.

 - In the Center mode: Center frequency and span are sent
See page 10 for Frequency data, and the Scope span settings to the right.
 - In the Fixed mode: Lower edge and higher edge frequencies are sent
See page 15 for Scope Fixed edge frequency settings ③ ~ ⑫.
- ⑥ Out of range information
 - 00 = In range, 01 = Out of range
 - If the scope data is out of range, the waveform data (⑦) is omitted.

⑦ Waveform data

The transceiver outputs the drawn waveform data. The data range or data length of the waveform data is judged by the controller. (The data range is basically the same as the display size of the scope on the controller.)

Data range	0 ~ 200
Data length	689

• Center/Fixed mode settings

Command: 27 14

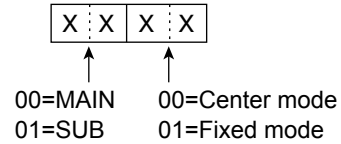

• Scope span settings

Command: 27 15

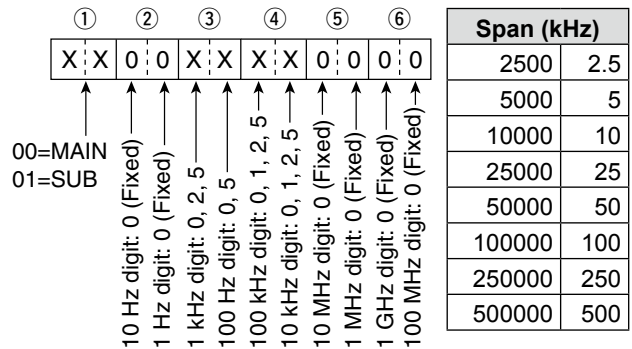

• Scope Edge number settings

Command: 27 16

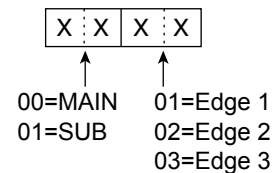

• Scope Hold settings

Command: 27 17

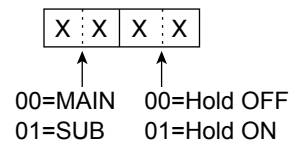

Count on us!

