



INSTRUCTION MANUAL

VHF/UHF FM TRANSCEIVER
IC-207H

**Downloaded by
RadioAmateur.EU**

This device complies with Part 15 of the FCC rules. Operation is subject to the following two conditions: (1) This device may not cause harmful interference, and (2) this device must accept any interference received, including interference that may cause undesired operation.

Icom Inc.

IMPORTANT

READ ALL INSTRUCTIONS carefully and completely before using the transceiver.

SAVE THIS INSTRUCTION MANUAL—This instruction manual contains important operating instructions for the IC-207H.

EXPLICIT DEFINITIONS

The explicit definitions below apply to this instruction manual.

WORD	DEFINITION
⚠ WARNING	Personal injury, fire hazard or electric shock may occur.
CAUTION	Equipment damage may occur.
NOTE	If disregarded, inconvenience only. No risk of personal injury, fire or electric shock.

CAUTIONS

⚠ WARNING! NEVER connect the transceiver to an AC outlet. This may pose a fire hazard or result in an electric shock.

⚠ WARNING! NEVER operate the transceiver while driving a vehicle. Safe driving requires your full attention—anything less may result in an accident.

NEVER connect the transceiver to a power source of more than 16 V DC. This connection will ruin the transceiver.

NEVER connect the transceiver to a power source using reverse polarity. This connection will ruin the transceiver.

NEVER cut the DC power cable between the DC plug and fuse holder. If an incorrect connection is made after cutting, the transceiver might be damaged.

NEVER place the transceiver where normal operation of the vehicle may be hindered or where it could cause bodily injury.

NEVER let objects impede the operation of the cooling fan on the rear panel.

DO NOT push the PTT when not actually desiring to transmit.

DO NOT allow children to play with any radio equipment containing a transmitter.

During mobile operation, **DO NOT** operate the transceiver without running the vehicle's engine. When transceiver power is ON and your vehicle's engine is OFF, the vehicle's battery will soon become exhausted.

BE CAREFUL! The transceiver will become hot when operating it continuously for long periods.

AVOID using or placing the transceiver in areas with temperatures below -10°C ($+14^{\circ}\text{F}$) or above $+60^{\circ}\text{C}$ ($+140^{\circ}\text{F}$) or in areas subject to direct sunlight, such as the dashboard.

AVOID the use of chemical agents such as benzine or alcohol when cleaning, as they can damage the transceiver surfaces.

USE Icom microphones only (supplied or optional). Other manufacturer's microphones have different pin assignments and may damage the transceiver if attached.



Note that in this manual, sections beginning with a microphone icon (as at left) designate operation via the HM-98 microphone.

UNPACKING

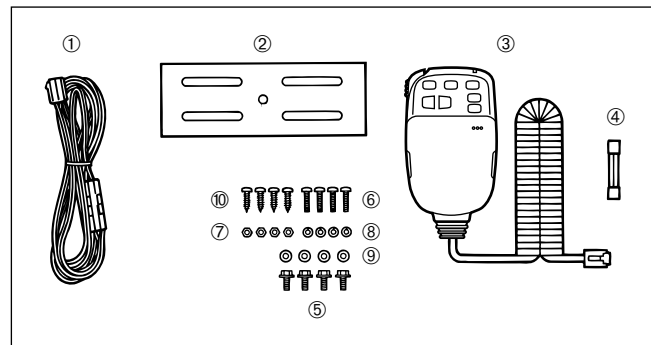

Accessories included with the transceiver:

	Qty.
① DC power cable (OPC-346).....	1
② Mobile mounting bracket	1
③ Microphone (HM-98*)	1
④ Fuse (20 A).....	1
⑤ Knob bolt (M4 × 8)	4
⑥ Mounting bolt (M5 × 12).....	4
⑦ Nut (M5).....	4
⑧ Spring washer (M5)	4
⑨ Flat washer (M5).....	4
⑩ Self-tapping screws (A0 5 × 16).....	4

*Some versions are supplied with the HM-96 instead.

TABLE OF CONTENTS

IMPORTANT	i
EXPLICIT DEFINITIONS	i
CAUTIONS	i
UNPACKING	ii
TABLE OF CONTENTS	iii
1 PANEL DESCRIPTION	1 – 8
■ Front panel	1
■ Function display	3
■ Rear panel	5
■ Microphone	6
■ Microphone keypad	7
2 INSTALLATION	9 – 14
■ Installation methods	9
■ Location	10
■ Single body installation	10
■ Microphone connection	11
■ Separate installation	11
■ Optional MB-58 installation	12
■ Battery connection	13
■ DC power supply connection	13
■ Antenna installation	14
3 SETTING A FREQUENCY	15 – 19
■ Preparation	15
■ Lock functions	16
■ Using the tuning dial	17
■ Using [▲]/[▼] switches	17
■ Tuning step selection	18
■ Using the keypad	19
4 BASIC OPERATION	20 – 23
■ Receiving	20
■ Monitor function	21
■ Audio mute function	21
■ Avionics band receive	21
■ Transmitting	22
■ Selecting the output power	22
■ One-touch PTT function	23
5 REPEATER OPERATION	24 – 28
■ Accessing a repeater	24
■ Subaudible tones	26
■ Offset frequency	27
■ Auto repeater	28
6 MEMORY OPERATION	29 – 33
■ General description	29
■ Memory channel selection	29
■ Programming a memory channel	30
■ Programming a memory channel via the microphone	31
■ Transferring memory contents	32
■ Memory clearing	33
7 CALL CHANNEL OPERATION	34 – 35
■ Calling up a call channel	34
■ Transferring call channel contents	34
■ Programming a call channel	35
8 SCRATCH PAD MEMORY	36 – 37
■ What is a scratch pad memory?	36
■ Calling up a scratch pad memory	36
■ Transferring scratch pad memory contents	37

9 SCAN OPERATION	38 – 43	14 OTHER FUNCTIONS	59 – 66
■ Scan types	38	■ Beep tones on/off	59
■ Scan start/stop	39	■ Time-out timer	59
■ Programming scan edges	40	■ Auto power-off	60
■ Programming scan edges via the microphone	41	■ Cooling fan setting	60
■ Skip channel setting	42	■ Microphone [F-1]/[F-2] keys	61
■ Scan resume condition	43	■ Display dimmer setting	61
10 PRIORITY WATCH	44 – 45	■ Demonstration display	62
■ Priority watch types	44	■ Squelch delay	62
■ Priority watch operation	45	■ Packet operation	63
11 DTMF MEMORY ENCODER	46 – 49	15 MAINTENANCE	67 – 69
■ Programming a DTMF code	46	■ Troubleshooting	67
■ Clearing the DTMF memory contents	46	■ Fuse replacement	69
■ Programming a DTMF code via the microphone	47	■ Partial resetting	69
■ Transmitting a DTMF code	48	■ Resetting the CPU	69
■ DTMF speed	49	16 SPECIFICATIONS	70
12 POCKET BEEP AND TONE SQUELCH	50 – 52	17 OPTIONS	71 – 72
■ Pocket beep operation	50	18 MODE ARRANGEMENT	73 – 74
■ Tone squelch operation	51		
■ Tone scan	52		
13 WIRELESS OPERATION	53 – 58		
■ Connection	53		
■ HM-90 WIRELESS MICROPHONE	53		
■ EX-1759 installation	54		
■ HM-90 switches	55		
■ Microphone address	58		

1

PANEL DESCRIPTION

■ Front panel

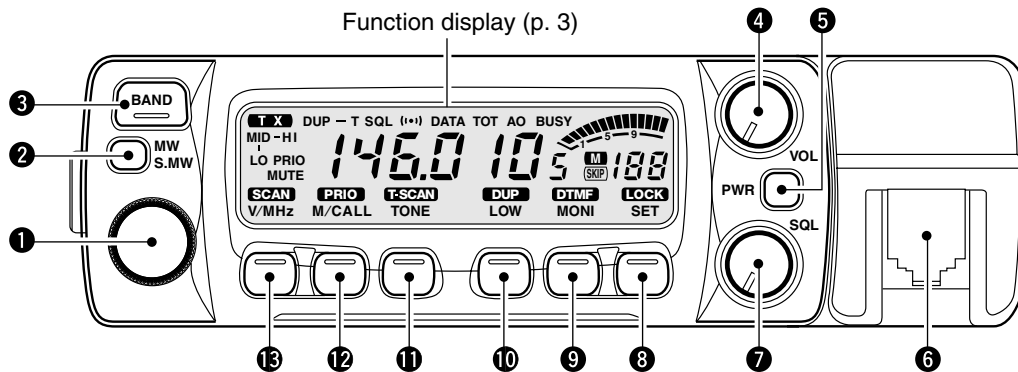

① TUNING DIAL

Selects the operating frequency (p. 17), the memory channel (p. 29), the contents of the set mode display and the scanning direction. (p. 39)

② SELECT MEMORY/MEMORY WRITE SWITCH [S.MW(MW)]

- Selects a memory channel for programming. (p. 30)
- Programs selected memory when pushed and held. (p. 30)

③ BAND SWITCH [BAND]

- Toggles between 144 and 430(440) MHz operation. (p. 15)

- When a call channel is selected, this switch toggles between the 2 available call channels. (p. 34)

④ VOLUME CONTROL [VOL]

Adjusts the audio level. (p. 20)

⑤ POWER SWITCH [PWR]

Turns power ON and OFF when pushed for 1 sec.

⑥ MICROPHONE CONNECTOR

Connects the supplied microphone. (p. 11)

⑦ SQUELCH CONTROL [SQL]

Varies the squelch level. (p. 20)

- RF attenuator activates and increases the attenuation when rotated clockwise to the center position and further.

8 SET/LOCK SWITCH [SET(LOCK)]

- Selects SET mode when pushed. (p. 70)
- Toggles the lock function ON and OFF when pushed and held. (p. 16)

9 MONITOR/DTMF SWITCH [MONI(DTMF)]

- Toggles squelch opened and closed when pushed. (pgs. 20, 24)
- Turns the DTMF memory encoder ON and OFF for auto patch operation when pushed and held. (p. 46)

10 OUTPUT POWER/DUPLEX SWITCH [LOW(DUP)]

- Each push changes the output power selection. (p. 22)
 - There are 4 output powers available: low, mid-low, mid-high and high.
- Push and hold to select a duplex setting. (p. 24)
 - There are 3 duplex settings available: minus duplex (“- DUP” appears, plus duplex (“+ DUP” appears) and simplex.

11 TONE/TONE SCAN SWITCH [TONE(T-SCAN)]

- Each push selects a tone function. (p. 50)
 - Tone encoder, pocket beep, tone squelch or tone function OFF can be selected.
- Push and hold to start/stop the tone scan function. (p. 52)

12 MEMORY/CALL CHANNEL SWITCH [M/CALL(PRIO)]

- Selects and toggles memory mode or a call channel (pgs. 29, 34)
- Activates the priority watch function when pushed and held. (p. 44)

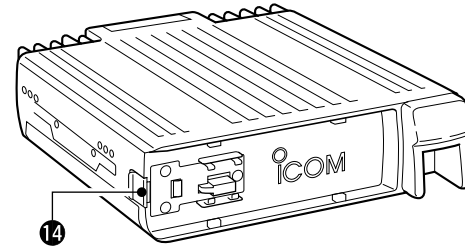

13 VFO/MHz SWITCH [V/MHz(SCAN)]

- Selects and toggles VFO mode and 1 MHz tuning display. (p. 17)
- Starts a scan when pushed and held. (p. 39)

14 FRONT PANEL RELEASE LATCH

While pushing this latch, slide the front panel to the left to remove it.

1 PANEL DESCRIPTION

■ Function display

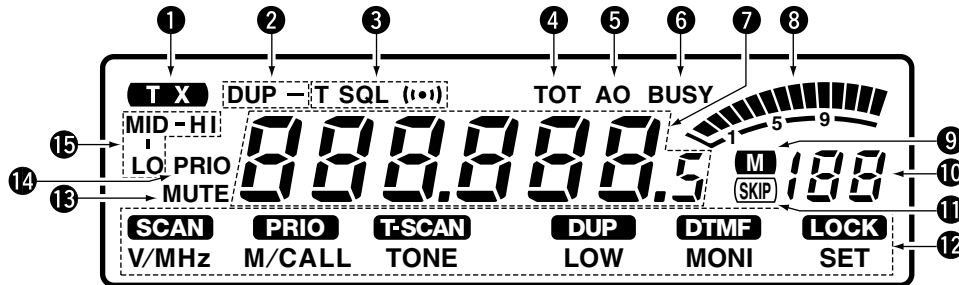

1 TRANSMIT INDICATOR (p.22)

- Appears while transmitting.
- Flashes while transmitting with the one-touch PTT function (p. 23).

2 DUPLEX INDICATORS (p. 24)

“DUP-” or “DUP” appears during semi-duplex operation (repeater operation).

3 TONE INDICATORS

- “T” appears while the subaudible tone encoder is in use. (p. 26)
- “T SQL” appears while the tone squelch function is in use. (p. 51)
- “T SQL (••)” appears while the pocket beep function is

in use. (p. 50)

4 TOT (TIME-OUT TIMER) INDICATOR (p. 59)

Appears while the time-out timer has been activated.

5 AUTO POWER-OFF INDICATOR (p. 60)

Appears while the auto power-off function is in use.

6 BUSY INDICATOR (p. 20)

Appears while a signal is being received or the squelch is open ([MONI] is being pushed).

7 FREQUENCY READOUT

- Shows the operating frequency, set mode contents, etc.
- The decimal point of the frequency flashes while scanning. (p. 39)
 - “d” appears in place of the 100 MHz digit while the DTMF memory function is in use.

8 S/RF INDICATORS (p. 22)

- ➔ Show the relative signal strength while receiving signals.
- ➔ Show the output power while transmitting.

9 MEMORY INDICATOR (p. 15)

Appears when memory mode is selected.

10 MEMORY CHANNEL READOUTS

- ➔ Show the selected memory channel numbers.
- ➔ A capital “L” appears while the frequency lock function is in use. (p. 16)
- ➔ “C1” or “C2” appears while on a call channel. (p. 34)
- ➔ One of “L1–L5” appears when a scratch pad memory is selected. (p. 36)
- ➔ One of “r1–r5” appears when a duplex scratch pad memory is selected. (p. 36)
- ➔ A small “c” appears when VFO mode is selected from the call channel or a scratch pad memory. (pgs. 34, 37)

11 SKIP INDICATOR (p. 42)

Appears when the displayed memory channel is specified as a skip channel.

12 SWITCH INDICATORS

Indicate the function(s) of the front panel switches directly below the function display.

13 AUDIO MUTE INDICATOR (p. 56)

Appears when the audio mute function is activated via microphone control.

- This function is cancelled when any switch or control is operated.

14 PRIORITY WATCH INDICATOR (p. 45)

Appears while the priority watch is activated; flashes while the watch is paused.

15 OUTPUT POWER INDICATORS (p. 22)

- ➔ “LO” appears for low output power. (5 W)
- ➔ “MID-LO” appears for mid-low output power. (10 W)
- ➔ “MID-HI” appears for mid-high output power. (20 W)
- ➔ “HI” appears for high output power. (50 W VHF; 35 W UHF)

1 PANEL DESCRIPTION

Downloaded by
RadioAmateur.EU

■ Rear panel

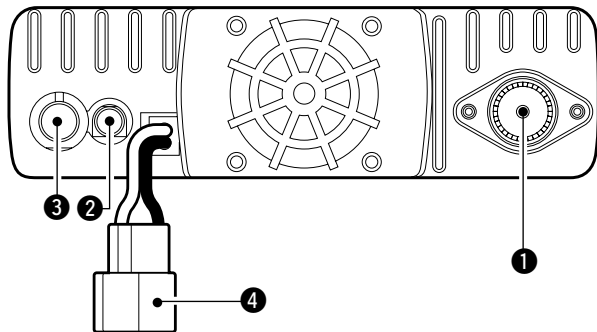

① ANTENNA CONNECTOR [ANT]

Accepts a 50 Ω dual band antenna with a PL-259 connector. (p. 14)

② SPEAKER JACK [SP]

Connects a 4–8 Ω speaker, if required. Outputs the selected band's audio.

③ DATA JACK [DATA]

6-pin mini DIN jack to connect a TNC, etc. for packet operation.

NOTE: The connection between this jack and the TNC differs depending on whether 1200 bps or 9600 bps operation is chosen in initial set mode (p. 63). See right for pin assignments.

④ POWER RECEPTACLE [DC13.8V]

Accepts 13.8 V DC with the supplied DC power cable.

◇ DATA JACK PIN ASSIGNMENTS

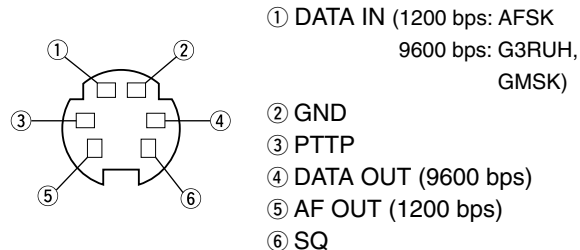

① DATA IN

Input terminal for data transmit. See p. 63 for details on how to toggle data speed between 1200 and 9600 bps.

② GND

Common ground for DATA IN, DATA OUT and AF OUT.

③ PTT

PTT terminal for packet operation only. Connect ground to transmit data.

④ DATA OUT

Data out terminal for 9600 bps operation only.

⑤ AF OUT

Data out terminal for 1200 bps operation only.

⑥ SQ (squelch out)

Becomes high (+5V) when the transceiver receives a signal which opens the squelch.

- To avoid unnecessary TNC transmission, connect squelch to the TNC to inhibit transmission when receiving signals.
- Keep audio output at a normal level, otherwise a "SQ" signal will not be output.

Microphone (HM-98*)

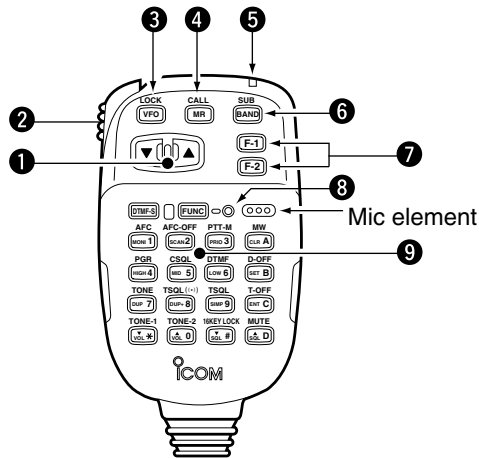

1 UP/DOWN SWITCHES [▲]/[▼]

- ➔ Push either switch to change the operating frequency, memory channel, set mode contents, etc. (pgs. 17, 29)
- ➔ Push and hold either switch to start scanning. (p. 39)

2 PTT SWITCH

- ➔ Push and hold to transmit; release to receive. (p. 22)
- ➔ Toggles between transmitting and receiving while the one-touch PTT function is in use. (p. 23)

3 VFO SWITCH [VFO(LOCK)]

- ➔ Push to select VFO mode.
- ➔ Push and hold to toggle the lock function ON and OFF.

4 MEMORY SWITCH [MR(CALL)]

- ➔ Push to select memory mode. (p. 29)
- ➔ Push and hold to select the call channel. (p. 34)

5 ACTIVITY INDICATOR

Lights red while a key is pushed; lights green while the one-touch PTT function is in use.

6 BAND SWITCH

Push to toggle the operating band. (p. 15)

7 FUNCTION SWITCHES [F-1]/[F-2] (p. 61)

Assign your desired key function from the front panel switches.

- Default settings are [LOW] for [F-1] and [TONE] for [F-2].

8 FUNCTION INDICATOR

- ➔ Lights orange while [FUNC] is activated—indicates the secondary function of switches can be accessed.
- ➔ Lights green when [DTMF-S] is activated—DTMF signals can be transmitted with the keypad. (p. 48)













9 KEYPAD









Used for controlling the transceiver, transmitting a DTMF encoder, etc. See the following 2 pages for details.

*Some versions are supplied with the HM-96 instead.

1 PANEL DESCRIPTION

■ Microphone keypad

KEY	FUNCTION	SECONDARY FUNCTION (after )	OTHER FUNCTIONS
	Toggles between opening and closing the operating band's squelch. (p. 21)	No secondary function.	After  : Transmit the appropriate DTMF code or push [0] to [9], [A] to [D] to transmit the DTMF memory contents when the DTMF memory encoder is activated. (p. 48)
	Starts and stops scanning. (p. 39)	No secondary function.	
	Starts and stops priority watch. (p. 45)	Turns the one-touch PTT function ON and OFF. (p. 23)	
	Selects high output power. (p. 22)	No secondary function.	
	Selects mid-high output power. (p. 22)	No secondary function.	
	Selects low output power. (p. 22)	Turns the DTMF memory encoder function ON. (p. 47)	
	Selects –duplex. (p. 25)	Turns the subaudible tone encoder ON. (p. 25)	
	Selects +duplex. (p. 25)	Turns the pocket beep function ON. (p. 50)	
	Selects simplex (p. 25)	Turns the tone squelch function ON. (p. 51)	
	Increases the audio output. (p. 20) <ul style="list-style-type: none"> The [VOL] control on the front panel has priority when rotated. 	While being pushed, transmits a 1750 Hz tone. (p. 25)	

KEY	FUNCTION	SECONDARY FUNCTION (after )	OTHER FUNCTIONS
	<ul style="list-style-type: none"> • Clears a digit before entry. (p. 19) • Cancels the scan, priority watch or DTMF memory function. (pgs. 39, 45, 48) 	<ul style="list-style-type: none"> • Writes the VFO contents into the memory channel or call channel. (pgs. 31, 35) • Advances the memory channel number when continuously pushed after programming is completed. (p. 31) 	<p>[A] to [D] transmit DTMF memories. (p. 48)</p> <p>After  :</p> <p>Transmit the appropriate DTMF code. (p. 48)</p>
	Enters set mode and advances the set mode selection order.	DTMF memory OFF.	
	<ul style="list-style-type: none"> • Sets the keypad for numeral input. (p. 19) • Decreases the set mode selection order after entering set mode. 	Turns the subaudible tone encoder, pocket beep or tone squelch OFF. (pgs. 25, 50, 51)	
	<ul style="list-style-type: none"> Increases the squelch level. (p. 20) • The [SQL] control on the front panel has priority when rotated. 	<ul style="list-style-type: none"> Mutes the operating band's audio. (p. 21) • Mute function is released when any operation is performed. 	
	<ul style="list-style-type: none"> Decreases the squelch level. (p. 20) • The [SQL] control on the front panel has priority when rotated. 	Locks the digit keys on the keypad (including the A–D, # and * keys. (p. 16)	
	<ul style="list-style-type: none"> Decreases the audio output. (p. 20) • The [VOL] control on the front panel has priority when rotated. 	Sends a 1750 Hz tone signal for 0.5 sec. (p. 25)	

■ Installation methods

◇ Single body installation

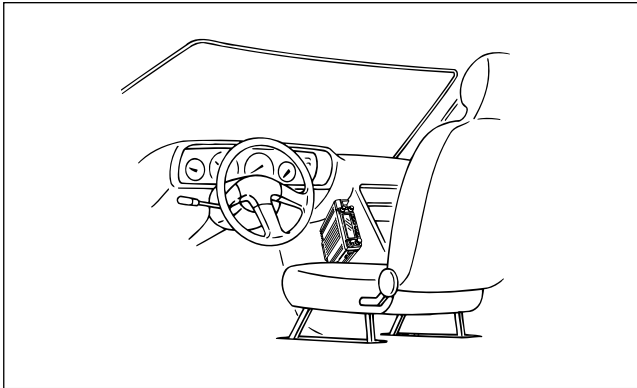

- It is not necessary to purchase a mounting bracket. The supplied mounting bracket (or optional MB-17A) can be used for installation.

◇ Separate installation

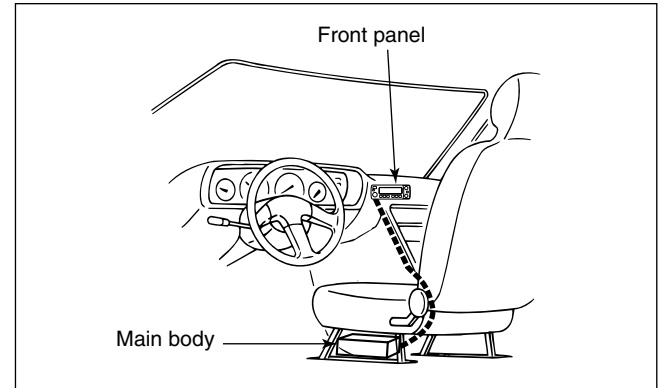

- Optional OPC-600 SEPARATION CABLE (3.5 m; 11.5 ft) or OPC-601 (7.0 m; 23.0 ft) is necessary.
- Optional MB-58 REMOTE CONTROLLER BRACKET is available for front panel mounting.
- Optional MB-65 MOUNTING BASE is available for increasing front panel mounting possibilities (MB-58 is necessary).
- Optional OPC-440 MICROPHONE CABLE (5.0 m; 16.4 ft) and OPC-647 (2.5 m; 8.2 ft) are available to extend the microphone cable.
- Optional OPC-441 SPEAKER CABLE (5.0 m; 16.4 ft) is available to extend the speaker cable.

■ Location

Select a location which can support the weight of the transceiver and does not interfere with driving in any way. We recommend the locations shown in the diagram below.

NEVER place the transceiver or remote controller where normal operation of the vehicle may be hindered or where it could cause bodily injury.

NEVER place the transceiver or remote controller where air bag deployment may be obstructed.

DO NOT place the transceiver or remote controller where hot or cold air blows directly onto it.

AVOID placing the transceiver or remote controller in direct sunlight.

• EXAMPLE INSTALLATION LOCATIONS

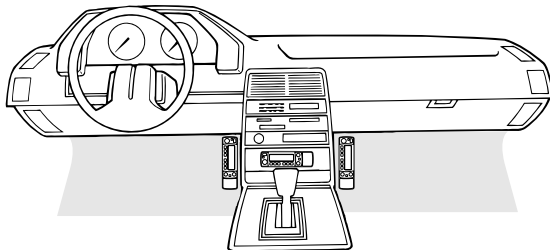

■ Single body installation

- ① Drill 4 holes where the mounting bracket is to be installed.
 - Approx. 5.5–6 mm ($\frac{9}{16}$ in) when using nuts; approx. 2–3 mm ($\frac{1}{16}$ in) when using self-tapping screws.
- ② Insert the supplied screws, nuts and washers through the mounting bracket and tighten.
- ③ Adjust the angle for the clearest view of the function display.

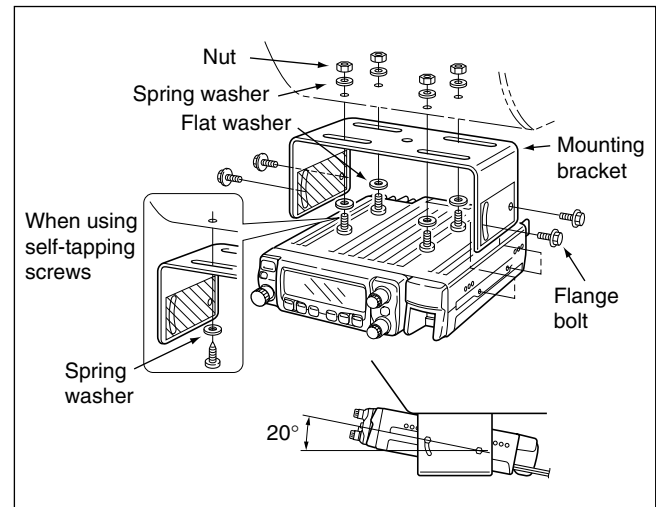

2 INSTALLATION

■ Microphone connection

The microphone connector is located behind the front panel. Connect the supplied microphone as follows:

- ① Slide the supplied microphone cable connector (and attached microphone) into the microphone jack on the main body of the transceiver until it clicks into place.
- ② To remove the microphone, push the release lever on the bottom of the microphone cable connector.

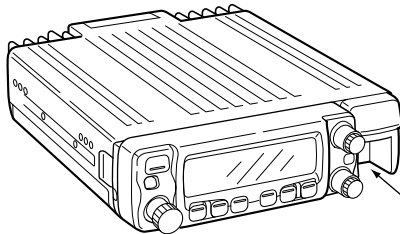

Connect microphone here

Microphone pin assignments

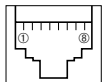

- ① 8 V OUT
- ② Freq. up/down
- ③ 8 V control IN
- ④ PTT
- ⑤ Mic AF (-)
- ⑥ Mic AF (+)
- ⑦ Ground
- ⑧ Data IN

■ Separate installation

Using an optional OPC-600/601 SEPARATION CABLE, the front panel can be separated from the main body, doubling as a remote controller.

- ① Detach the front panel as at right.
- ② Connect a separation cable between the front panel and main body using the supplied screws as illustrated below.

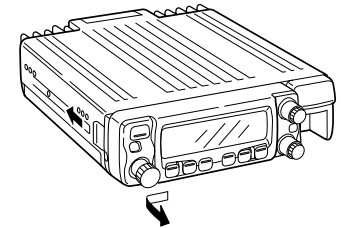

Rear of front panel

Main body

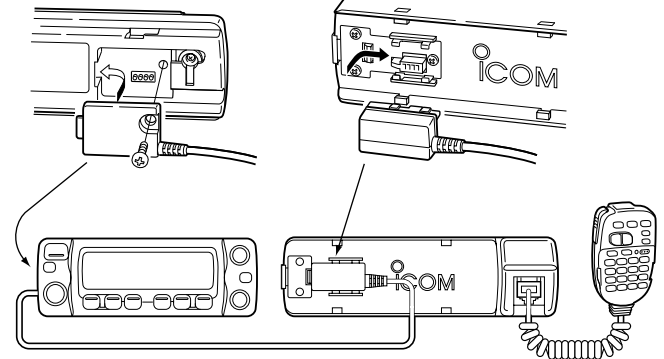

OPC-600 or OPC-601

■ Optional MB-58 installation

The optional MB-58 REMOTE CONTROLLER BRACKET is available for separate installation.

- ① Drill 2 or 4 holes where the bracket or mounting base is to be installed, respectively.
 - Approx. 4 mm ($\frac{1}{8}$ in) when using nuts; approx. 1–2 mm ($\frac{1}{16}$ in) when using self-tapping screws.
- ② Insert the supplied screws, bolts and washers through the mounting base and tighten.
- ③ Adjust the angle for the clearest view of the function display and tighten 2 screws when the mounting base is used.

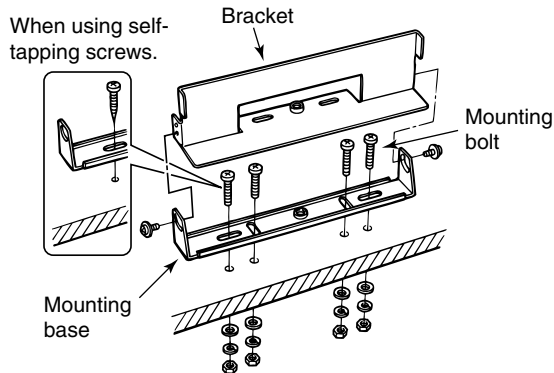

- ④ Attach the supplied Velcro pads (large) to the remote controller and bracket.
- ⑤ Attach the supplied Velcro pad (small) or rubber pad to the bracket as shown below; then attach the remote controller.

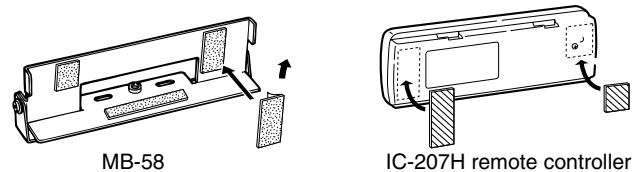

◇ When using the MB-65

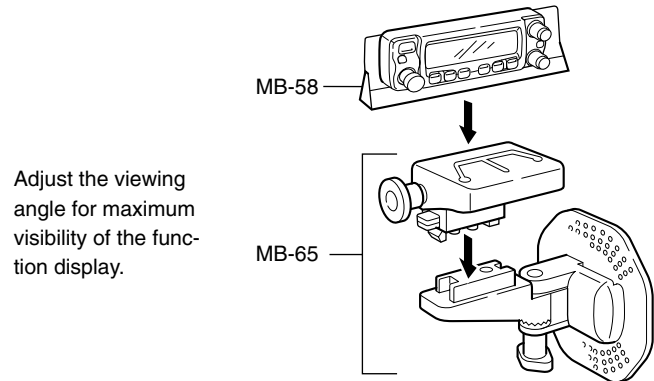

2 INSTALLATION

■ Battery connection

NEVER connect the transceiver directly to a 24 V battery.
DO NOT use the cigarette lighter socket for power connections.

Attach a rubber grommet when passing the DC power cable through a metal plate to prevent short circuits.

• CONNECTING TO A DC POWER SOURCE

See p. 69 for fuse replacement.

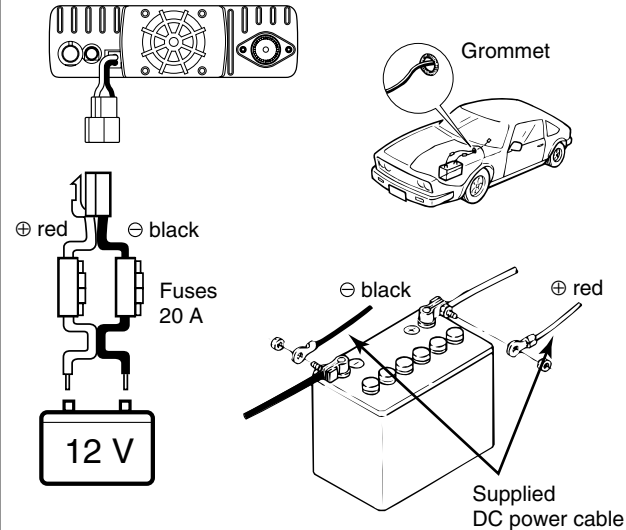

■ DC power supply connection

Use a 13.8 V DC power supply with more than 12 A capability. An optional IC-PS30 DC POWER SUPPLY is available for using the transceiver with a DC power supply in your home.

Make sure the ground terminal of the DC power supply is grounded.

• CONNECTING TO A DC POWER SUPPLY

See p.69 for fuse replacement.

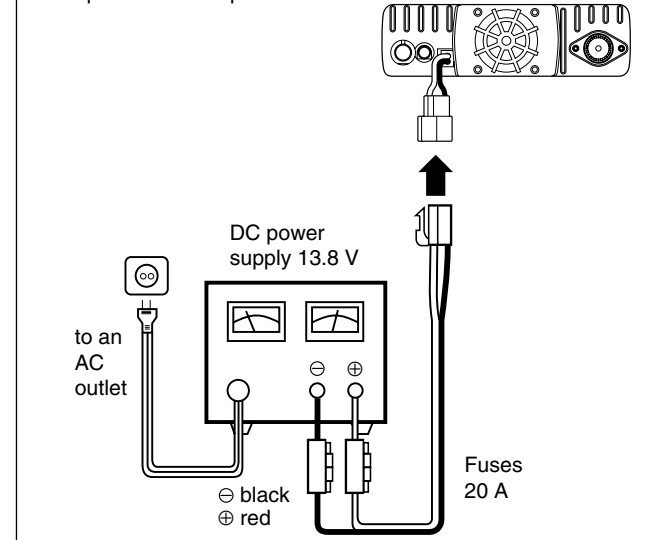

■ Antenna installation

◇ Antenna location

To obtain maximum performance from the transceiver, select a high-quality antenna and mount it in a good location. A non-radial antenna should be used when using a magnetic mount.

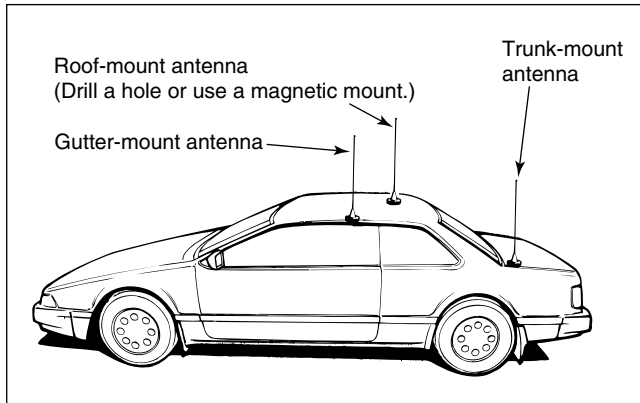

◇ Antenna splitter

You can use a dual band antenna because a duplexer is installed in the transceiver. However, an external duplexer must be connected when using a separate antenna for each band.

◇ Antenna connector

The antenna uses a PL-259 connector.

• PL-259 CONNECTOR

- ① Slide the coupling ring down. Strip the cable jacket and soft solder.

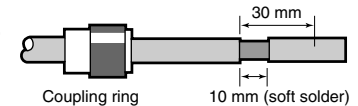

- ② Strip the cable as shown at right. Soft solder the center conductor.

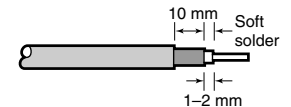

- ③ Slide the connector body on and solder it.

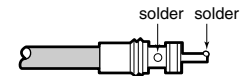

- ④ Screw the coupling ring onto the connector body.

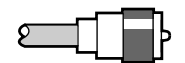

(10 mm \approx $\frac{3}{8}$ in)

3

SETTING A FREQUENCY

■ Preparation

◇ Turning power ON/OFF

Push [PWR] for 1 sec. to turn power ON or OFF.

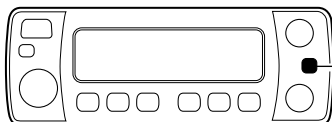

Push [PWR] for 1 sec.

◇ Operating band

The IC-207H can receive/transmit on the 144 MHz and 430(440) MHz bands, or receive only on the avionics band (USA version only).

Push [BAND] one or more times to select the desired operating band.

- The frequency changes to indicate the selected band.
- The operating band cannot be changed unless you are in VFO mode (see right).



Push [BAND] one or more times to select the desired operating band.

◇ VFO and memory modes

The transceiver has 2 normal operating modes: VFO mode and memory mode.

Push [V/MHz] to select VFO mode when the transceiver is not in VFO mode.

- If VFO mode is already selected, the digits below 100 kHz disappear. In this case, push [V/MHz] again (or push twice depending on version).

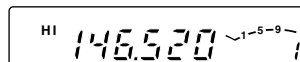

VFO mode is selected.

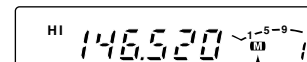

Appears when memory mode is selected.



Push [VFO] to select VFO mode.

Downloaded by
RadioAmateur.EU

■ Lock functions

To prevent accidental frequency changes and unnecessary function access, use the lock function. The transceiver has 2 different lock functions.

◇ Frequency lock

This function locks the tuning dial and switches electronically and can be used together with the microphone lock function.

Push and hold **LOCK** until “L” appears in the memory channel readout to activate the function.

- To cancel the function, push and hold **LOCK** until “L” disappears.
- [PTT], [MONI], [VOL] and [SQL] can be used while the frequency lock function is in use. Also, TONE-1, TONE-2, DTMF tones or DTMF memory contents can be transmitted from the microphone.

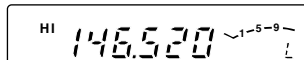

“L” appears while the frequency lock function is in use.



Push and hold [(VFO)LOCK] for 1 sec. to toggle the function ON and OFF.

◇ Microphone keypad lock

This function locks the microphone keypad.



Push [FUNC] then [#16 KEYLOCK] to toggle the microphone keypad lock function ON and OFF.

- [PTT] and the 7 keys on the upper half of the microphone can be used.
- All switches on the transceiver can be used.
- The keypad lock function is released when the power is turned OFF then ON again.

3 SETTING A FREQUENCY

■ Using the tuning dial

- ① Push [BAND] to select the desired band, if necessary.
- ② Rotate the tuning dial to set the frequency.
 - If VFO mode is not selected, push the [V/MHz] to select VFO mode.
 - Frequency changes according to the selected tuning steps. (p. 18)
- ③ For the 1 MHz frequency setting, rotate the tuning dial after pushing [V/MHz].
 - Pushing [V/MHz] for 1 sec. starts a scan function. If this happens, push [V/MHz] again to stop the scan.

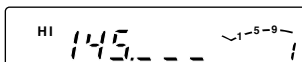

The display shows that the 1 MHz tuning step is selected for the VHF band.

■ Using [▲]/[▼] switches



Push [▲] or [▼] to set the selected band's frequency.

- If VFO mode is not selected, push [VFO] to select it.
- Frequency changes according to the selected tuning steps. (p. 18)
- Pushing [▲] or [▼] for more than 0.5 sec. activates a scan. If this happens, push [▲] or [▼] again to stop it.

NOTE: 1 MHz steps cannot be used via the [▲]/[▼] switches.

■ Tuning step selection USING SET MODE

Tuning steps are the minimum frequency change increments when you rotate the tuning dial or push the [▲] or [▼] switches on the microphone. The following tuning steps are available:

- 5 kHz • 10 kHz • 12.5 kHz • 15 kHz
- 20 kHz • 25 kHz • 30 kHz • 50 kHz

NOTE: For convenience, select a tuning step that matches the frequency intervals of repeaters in your area.

- ① Push [BAND] to select the desired band, if necessary.
- ② Push [V/MHz] to select VFO mode if another mode has been selected.
- ③ Push [SET] one or more times until “tS” appears below.
 - Pushing [MONI] reverses the order of selection.
 - Cancel the DTMF memory function in advance. (p. 48)
- ④ Rotate the tuning dial to select the tuning step.
- ⑤ Push [V/MHz] to exit set mode.

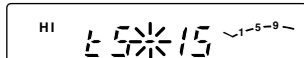

15 kHz tuning step

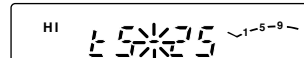

25 kHz tuning step



- ① Push [BAND] to select the operating band, if necessary.
- ② Push [VFO] to select VFO mode.
- ③ Push [ⓈSET] one or more times until “tS” appears as shown previously.
 - Push [ENT] to reverse the order of selection.
 - Cancel the DTMF memory function in advance. (p. 48)
- ④ Push [▲] or [▼] to select the tuning step.
- ⑤ Push [CLR] to exit set mode.

3 SETTING A FREQUENCY

■ Using the keypad



The frequency can be directly set via numeral keys on the microphone.

- 1 Push [BAND] to set the operating band, if necessary.
- 2 Push [VFO] to select VFO mode.
- 3 Push [ENT] to activate the keypad for digit input.

- 4 Push 5 keys to input a frequency.
 - When a digit is mistakenly input, push [ENT] to clear the input, then input from the 1st digit.
 - Pushing [CLR] clears input digits and retrieves the frequency.
- 5 Push [▲] or [▼] to make adjustments below the 10 kHz digit, if desired.

[EXAMPLE]: Setting the frequency to 145.360 MHz.

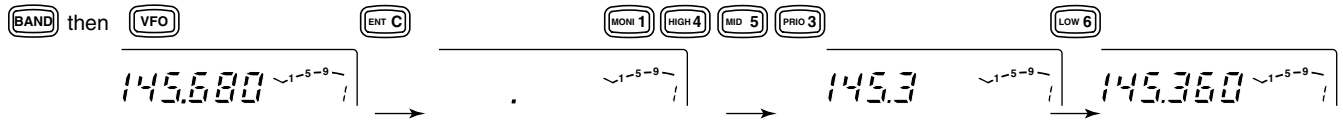

[EXAMPLE]: Setting the frequency to 446.325 MHz. (When the 25 kHz tuning step is selected in UHF.)

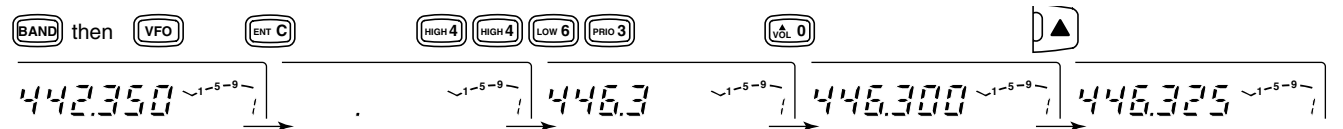

■ Receiving

- ① Push [PWR] for 1 sec. to turn power ON.
- ② Push [BAND] to select a band.
- ③ Set the audio level.
 - ➔ Push [MONI] to open the squelch.
 - ➔ Rotate the [VOL] control to adjust the audio output level.
 - ➔ Push [MONI] again to close the squelch.
- ④ Set the squelch level.
 - ➔ Rotate [SQL] fully counterclockwise in advance.
 - ➔ Rotate [SQL] clockwise until the noise just disappears.
 - ➔ When interference is received, rotate [SQL] clockwise again for attenuator operation.
- ⑤ Set the operating frequency. (pgs. 15–19)
- ⑥ When receiving a signal on the set frequency, squelch opens and the transceiver emits audio.
 - “BUSY” appears and the S/RF indicator shows the relative signal strength for a received signal.

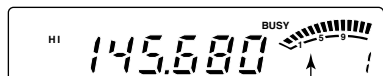

When receiving a signal on VHF.

The volume and squelch levels can be adjusted via the microphone. However, levels return to the front panel setting when power is turned OFF or a front panel control is adjusted.



① Push [PWR] on the transceiver for 1 sec. to turn power ON.

② Set the audio levels.

➔ Select the desired band.

➔ Push [⓪MONI], then push [⓪▼VOL] or [⓪▲VOL] to adjust the audio level.

➔ Push [⓪MONI] again to close the squelch.



③ Set the squelch level using [⓪▼SQL] or [⓪▲SQL], if desired.

④ Set the operating frequency. (pgs. 15–19)

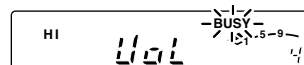

Appears while setting volume

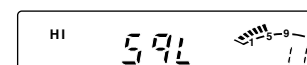

Appears while setting squelch

✓ CONVENIENT

RF attenuator: The transceiver has an RF attenuator related to the [SQL] setting. The attenuator is automatically activated when [SQL] is rotated further than the 12 o'clock position. Approx. 10 dB attenuation is obtained at full rotation.

4 BASIC OPERATION

■ Monitor function

This function is used to listen to weak signals without disturbing the squelch setting or to open the operating band's squelch manually even when mute functions such as tone squelch are in use.

Push [MONI] to open the operating band's squelch.

- Push [MONI] again to cancel the function.
- While duplex is ON for repeater operation, the transmitting frequency can be monitored with [MONI].



- ① Push [BAND] to change bands, if necessary.
- ② Push [①MONI] to open the operating band's squelch.
 - Push [①MONI] again to cancel the function.

■ Audio mute function



This function mutes the operating band's audio without disturbing the volume setting.

- ① Push [FUNC] then [①MUTE] to mute the operating band's audio signals
 - "MUTE" appears.
- ② Push [ⒶCLR] (or any other key) to cancel the function.
 - "MUTE" disappears.

■ Avionics band receive (U.S.A. version only)

AM mode can be selected over the range of 118.000 to 135.995 MHz for reception of avionics-related broadcasts.

- ① Push [BAND] one or more times to select the aviation band.
- ② Push and hold [BAND] to toggle between AM and FM modes.
 - Mode selection cannot be performed via the microphone.

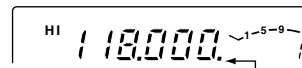

Appears when AM mode is selected.

✓ CONVENIENT

The tuning steps for the avionics band are available separately from those for other ranges.

■ Transmitting

CAUTION: Transmitting without an antenna may damage the transceiver.



NOTE: To prevent interference, listen on the frequency before transmitting by pushing [MONI] or [①MONI] on the microphone.

- ① Push [BAND] one or more times to select the operating band.
- ② Set the operating frequency. (pgs. 15–19)
 - Select output power if desired. See section at right for details.
- ③ Push and hold [PTT] to transmit.
 - “**TX**” appears.
 - The S/Rf indicator shows the output power selection.
 - The operating frequency, etc. are automatically programmed into a scratch pad memory. See p. 36 for details.
 - One-touch PTT function is available. See p. 23 for details.
- ④ Speak into the microphone using your normal voice level.
 - DO NOT hold the microphone too close to your mouth or speak too loudly. This may distort the signal.
- ⑤ Release [PTT] to return to receive.

■ Selecting the output power

The transceiver has 4 output power levels to suit your operating requirements. Low output powers during short-distance communications may reduce the possibility of interference to other stations and will reduce current consumption.

- ① Push [BAND] one or more times to select the operating band.
- ② Push [LOW] one or more times to select the desired output power.
 - The output power can be changed while transmitting.

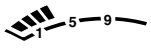
POWER SELECTION	S/Rf INDICATOR	VHF	UHF
HI		50 W	35 W
MID-HI		20 W	20 W
MID-LO		10 W	10 W
LO		5 W	5 W

4 BASIC OPERATION

HIGH
4

The microphone can select the desired output power directly.

① Push [BAND] to select the desired band, if necessary.

MID
5

② Push [④HIGH] for high output power; [⑤MID] for mid-high output power; [⑥LOW] for low output power.

- “MID-LO” output power CANNOT be selected via these microphone keys, however, the default setting for [F-1] is output power selection—“MID-LO” output power CAN be selected using [F-1], in this case.

LOW
6

- The output power CANNOT be changed via the microphone while transmitting.

■ One-touch PTT function

PTT-M
3

The PTT switch can be operated as a one-touch PTT switch (each push toggles transmit/receive). Using this function, you can transmit without pushing and holding the PTT switch.

To prevent accidental, continuous transmissions with the one-touch PTT function, the transceiver has a time-out timer. See p. 59 for details.

- ① Push [FUNC] then [③PTT-M] to turn the one-touch PTT function ON.
 - The activity indicator lights green.
- ② Push [PTT] to transmit and push again to receive.
 - Two beeps sound when transmission is started and a long beep sounds when returning to receive.
 - “TX” flashes while transmitting with the one-touch PTT function.
- ③ Push [FUNC] then [③PTT-M] to turn the one-touch PTT function OFF.
 - The activity indicator goes out.

■ Accessing a repeater

- ① Push [BAND] one or more times to select the desired band.
- ② Set the receive frequency (repeater output frequency).
(pgs. 15–19)
- ③ Push and hold **DUP** for 1 sec., one or more times, to select – duplex or + duplex.
 - “DUP –” or “DUP” appears to indicate the transmit frequency for minus shift or plus shift, respectively.
 - When the auto repeater function is turned ON, (available for the U.S.A. version only), steps ②, ③ are not necessary. (p. 31)

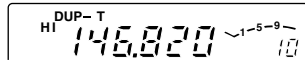

- ④ Push [TONE] one or more times to turn ON the subaudible tone encoder, according to repeater requirements.
 - Refer to p. 26 for tone frequency settings.
 - When the repeater requires a different tone system, see the page at right.

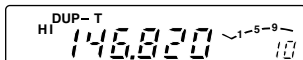

- ⑤ Push and hold [PTT] to transmit.
 - The displayed frequency automatically changes to the transmit frequency (repeater input frequency).
 - The operating condition is automatically programmed into a scratch pad memory. See p. 36 for details.

- If “oFF” appears, confirm the offset frequency. (p. 27)
- ⑥ Release [PTT] to receive.
- ⑦ Push [MONI] to check whether the other station’s transmit signal can be directly received or not.
- ⑧ To return to simplex, push **DUP** for 1 sec., once or twice, to clear the “DUP” indicator.
- ⑨ To turn OFF the subaudible tone encoder, push [TONE] one or more times until no tone indicators appear.

5 REPEATER OPERATION

DUP-
7

1 Push [BAND] to select the desired band, if necessary.

2 Set the receive frequency (repeater output frequency). (pgs. 15–19)

DUP+
8

3 Push [$\text{\textcircled{7}}$ DUP-] to select – duplex; push [$\text{\textcircled{8}}$ DUP+] for + duplex.

4 Push [FUNC] then [$\text{\textcircled{7}}$ TONE] to turn ON the subaudible tone encoder according to repeater requirements.

- Refer to p. 26 for tone frequency setting.
- When the repeater requires a different tone system, see at right.

5 Push and hold [PTT] to transmit.

6 Push and hold [$\text{\textcircled{1}}$ MONI] to check whether the other station's signal can be directly received.

7 Release [PTT] to receive.

8 To return to simplex operation, push [$\text{\textcircled{9}}$ SIMP].

SIMP
9

9 To turn OFF the subaudible tone encoder, push [FUNC], then [$\text{\textcircled{C}}$ T-OFF].

◇ DTMF tones

DTMF S

Push [DTMF-S], then push the keys of the desired DTMF digits.

- The function indicator lights green.
- 0–9, A–D, *(E) and #(F) are available.
- Cancel the DTMF memory encoder function in advance. (p. 48)
- Push [DTMF-S] again to return the keypad to normal function control.
- The transceiver has 14 DTMF memory channels for autopatch operation. See p. 46 for details.

◇ 1750 Hz tone

A 1750 Hz tone is required to access most European repeaters. The microphone has 1750 Hz tone capability.

TONE-1

1 Push [FUNC].

- The mode indicator lights orange.

2 Push [$\text{\textcircled{*}}$ TONE-1] to transmit a 1750 Hz tone call signal for 0.5 sec.; push and hold [$\text{\textcircled{2}}$ TONE-2] to transmit a 1750 Hz tone call signal for an arbitrary period.

TONE-2

- The mode indicator goes out automatically.
- The optional HM-90 also has 1750 Hz tone capability.

Downloaded by
RadioAmateur.EU

■ Subaudible tones

USING SET MODE

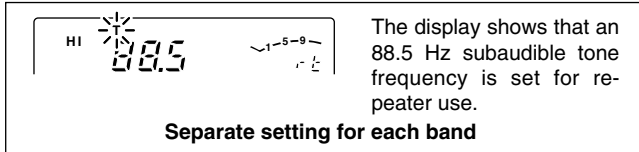

- ① Push [BAND] to select the desired band.
- ② Select the mode/channel you wish to set the subaudible tone frequency to, such as VFO mode or memory/call channel.
- ③ Push [SET] one or more times until “T” and “rT” appears for repeater use; or until “T SQL” and “CT” appears for tone squelch or pocket beep use.
 - Push [MONI] to reverse the order of selection.
 - Cancel the DTMF memory encoder function in advance. (p. 48)
- ④ Rotate the tuning dial to select and set the desired frequency.
- ⑤ Push [V/MHz] to exit set mode.

NOTE: The subaudible tone frequency can be set in a memory channel temporarily. However, the set contents are cleared once the memory/call mode is selected. To store the tone frequency permanently, overwrite the channel information.



- ① Push [BAND] to select the desired band, if necessary.
- ② Set the mode/channel you wish to set the subaudible tone frequency to, such as VFO mode, memory/call channel or scratch pad memory.
 - The subaudible tone frequency is independently programmed into each mode or channel.
- ③ Push [@SET] one or more times until “T” and “rT” appears for repeater use; or until “T SQL” and “CT” appears for tone squelch or pocket beep use.
 - Pushing [©ENT] reverses the order of selection.
 - Cancel the DTMF memory encoder function in advance. (p. 48)
- ④ Push [▲] or [▼] to select and set the desired frequency.
 - Pushing and holding [▲] or [▼] changes the frequency continuously.
- ⑤ Push [ⒶCLR] to exit set mode.

• Subaudible tone frequency list

(unit: Hz)

67.0	79.7	94.8	110.9	131.8	156.7	171.3	186.2	203.5	229.1
69.3	82.5	97.4	114.8	136.5	159.8	173.8	189.9	206.5	233.6
71.9	85.4	100.0	118.8	141.3	162.2	177.3	192.8	210.7	241.8
74.4	88.5	103.5	123.0	146.2	165.5	179.9	196.6	218.1	250.3
77.0	91.5	107.2	127.3	151.4	167.9	183.5	199.5	225.7	254.1

5 REPEATER OPERATION

■ Offset frequency

USING SET MODE

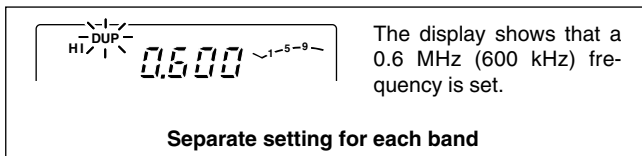

- ① Push [BAND] to select the desired band.
- ② Select the mode/channel you wish to set the offset frequency to, such as VFO mode or memory/call channel.
 - The offset frequency can be independently programmed into each mode or channel.
- ③ Push [SET] one or more times until “DUP” appears and flashes as shown above.
 - Pushing [MONI] reverses the order of selection.
 - Cancel the DTMF memory encoder in advance. (p. 48)
- ④ Rotate the tuning dial to set the desired frequency.
 - Selectable step increment is the same as the preset tuning step. (p. 18)
 - Use [V/MHz] for quick MHz setting.
- ⑤ Push [V/MHz] to exit set mode.

SET
B

- ① Push [BAND] to select the desired band, if necessary.
- ② Set the mode/channel you wish to set the offset frequency to, such as VFO mode or memory/call channel.
 - The offset frequency can be independently programmed into each mode or channel.
- ③ Push [SET] one or more times until “DUP” appears and flashes as shown at left.
 - Pushing [ENT] reverses the order of selection.
 - Cancel the DTMF memory encoder in advance. (p. 48)
- ④ Push [▲] or [▼] to select and set the desired frequency.
 - Selectable step increment is the same as the preset tuning step. (p. 18)
 - Pushing and holding [▲] or [▼] changes the frequency continuously.
- ⑤ Push [CLR] to exit set mode.

NOTE: The offset frequency can be set in a memory channel temporarily. However, the set contents are cleared once the memory/call mode is selected. To store the offset frequency permanently, overwrite the channel information.

■ Auto repeater (U.S.A. version only)

USING INITIAL SET MODE

The U.S.A. version automatically activates the repeater settings (DUP or DUP– and tone encoder ON/OFF) when the operating frequency falls within the general repeater output frequency range and deactivates them when outside of the range.

◇ Setting the auto repeater function ON/OFF

- ① Push [PWR] to turn power OFF.
- ② While pushing [SET] (far right switch), turn power ON to enter initial set mode.
- ③ Push [SET] one or more times until the “rPt” display appears as shown below.

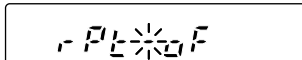

Auto repeater function is turned OFF

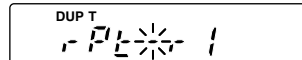

Auto repeater function is ON, tone encoder is OFF.

- ④ Rotate the tuning dial to turn the auto repeater function to “r1,” “r2” or OFF.
 - “r1”: auto repeater is ON, tone encoder is OFF;
 - “r2”: auto repeater is ON, tone encoder is ON.
- ⑤ Push [PWR] momentarily to exit initial set mode.

◇ Frequency range and offset direction

FREQUENCY RANGE	DUPLEX DIRECTION
145.200–145.495 MHz 146.610–146.995 MHz	“DUP–” appears
147.000–147.395 MHz	“DUP” appears
442.000–444.995 MHz	“DUP” appears
447.000–449.995 MHz	“DUP–” appears

■ General description

The transceiver has 150 regular memory channels, 10 scan edge memory channels (5 pairs) plus 2 call channels (by default C1 is for VHF and C2 is for UHF, however both can be set to VHF or both to UHF as desired); each of these can be individually programmed with the following data.

- Operating frequency (pgs. 15–19)
- Duplex direction (DUP or DUP–) and its offset frequency (pgs. 24, 25, 27)
- Subaudible tone encoder or tone squelch and its tone frequency (pgs. 24–26)
- Skip information* (p. 42)

*Except for the scan edge memory channels.

■ Memory channel selection

◇ Using the tuning dial

- ① Push [M/CALL] once or twice to display “**M**”.
- ② Rotate the tuning dial to select the desired memory channel.
 - Only programmed memory channels can be selected.

◇ Using [▲]/[▼] switches



- ① Push [BAND] to select the desired band, if necessary.
- ② Push [MR] to select memory mode.
- ③ Push [▲] or [▼] several times to select the desired memory channel.
 - Pushing [▲]/[▼] more than 0.5 sec. activates a scan.
 - If a scan is activated, push [▲] or [▼] again to stop it.

◇ Using the keypad



- ① Push [BAND] to select the desired band, if necessary.
- ② Push [MR] to select memory mode.
- ③ Push [©ENT] to activate the keypad for numeral input.
- ④ Push 2 appropriate digit keys to input a channel number.
 - When inputting non-programmed channel numbers the previous memory channel appears.
 - To select scan edge channels, “*#” and “#” can be used for A and b respectively.

■ Programming a memory channel

VFO mode settings, including the set mode contents such as subaudible tone frequency, etc., can be programmed into a memory channel.

- ① Set the desired frequency in VFO mode:
 - ➔ Push [V/MHz] to select VFO mode.
 - ➔ Set the frequency using the tuning dial.
 - ➔ Set other data (e.g. tone frequency, etc.) if required.
- ② Push [S.MW] momentarily.
 - “M” and the memory channel number flash.
- ③ Rotate the tuning dial to select the memory channel to be

programmed.

- Memory channels not yet programmed are blank.
- ④ Push [S.MW] for 1 sec. to program.
 - 3 beeps may sound.
 - Memory channel number automatically advances when continuing to push [S.MW] after programming.

✓ CONVENIENT

Memory programming can be performed in versatile ways e.g. memory channel to the same (or different) memory channel, memory channel to the call channel, etc.

[EXAMPLE]: Programming 145.870 MHz into memory channel 20 via the remote controller.

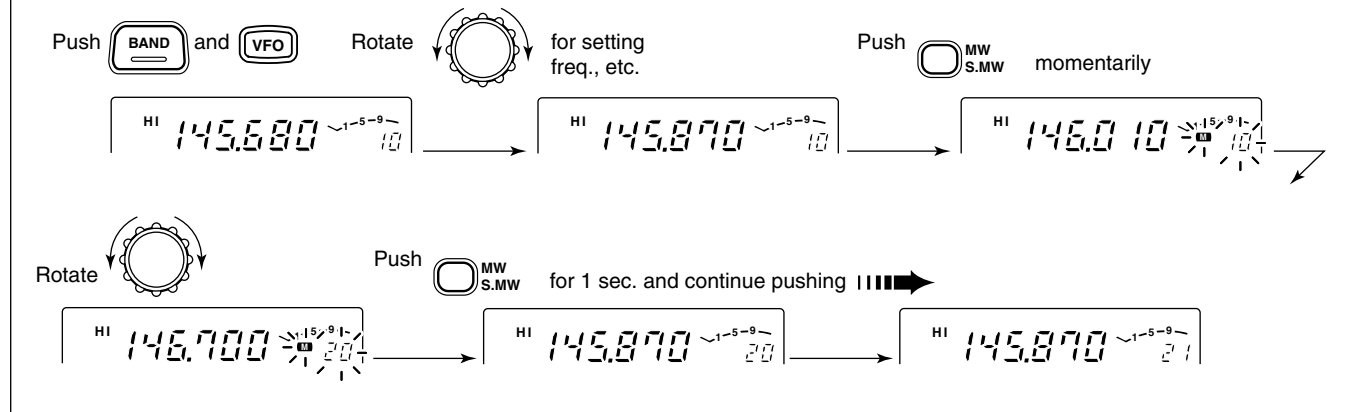

6 MEMORY OPERATION

■ Programming a memory channel via the microphone



Memory channel programming can be performed via the microphone.

- 1 Push [BAND] to select the desired band, if necessary.
- 2 Set the desired frequency in VFO mode:
 - ➔ Push [VFO] to select VFO mode.
 - ➔ Set the frequency using the keypad.
 - ➔ Set other data (e.g. offset frequency, duplex direction, subaudible tone encoder ON/OFF and its frequency), if required.
- 3 Push [FUNC] then [▲MW] momentarily.
- 4 Select the memory channel to be programmed:
 - ➔ Push [▲] or [▼] to select the memory channel (direct numeral input cannot be used).
- 5 Push [FUNC] then [▲MW] for 1 sec. to program.
 - ➔ 3 beeps may sound and the VFO contents (including the sub-audible tone frequency, etc.) are programmed.
 - ➔ Memory channel number advances when continuing to push [MW] after programming.

[EXAMPLE]: Programming 145.870 MHz into memory channel 20 via the microphone.

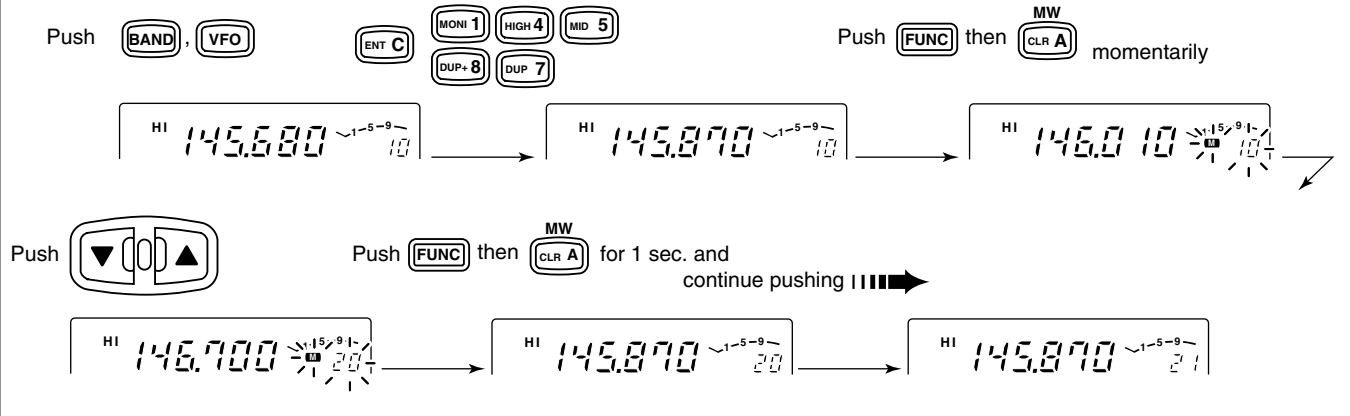

■ Transferring memory contents

This function transfers a memory channel's contents into a VFO (or another memory/call channel). This is useful when searching for signals around a memory channel frequency and for recalling the offset frequency, subaudible tone frequency, etc.

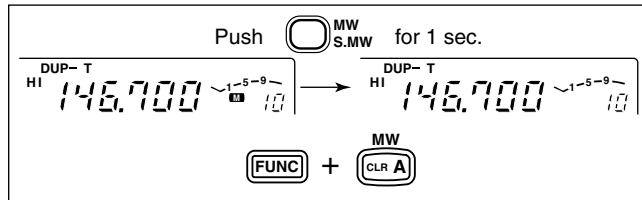

- ① Push [BAND] one or more times to select a band.
- ② Select the memory channel to be transferred:
 - ➔ Select memory mode by pushing [M/CALL] once or twice ("M" appears).
 - ➔ Rotate the tuning dial to select the memory channel.
- ③ Push [S.MW] momentarily, then rotate the tuning dial to select another memory channel to transfer.
 - To transfer to the VFO, push and hold [(S.MW)MW] instead of pushing momentarily.
- ④ Push and hold [(S.MW)MW] to transfer when a momentary push was used in the previous step.

MW

- ① Push [BAND] to select the desired band, if necessary.
- ② Select the memory channel to be transferred:
 - ➔ Push [MR] to select memory mode.
 - ➔ Push [▲] or [▼] to select the memory channel; or push [ENT] then push the desired memory channel number (2 digits) to select the memory channel directly.
- ③ Push [FUNC] then [▲MW] momentarily, then push [▲] or [▼] to select another memory channel to transfer.
 - To transfer to the VFO, push [FUNC] then push and hold [▲MW] instead of pushing momentarily.
- ④ Push [FUNC] then [▲MW] for 1 sec. to transfer when a momentary push was used in the previous step.

6 MEMORY OPERATION

■ Memory clearing

Contents of programmed memories can be cleared (blanked), if desired.

- ① Push [S.MW] momentarily.
- ② Select the memory channel to be cleared with the tuning dial.
- ③ Push [S.MW] briefly, then a second time for 1 sec.
 - 3 beeps sound, then the frequency is cleared.
 - “**M**” flashes continuously.
 - Scan edges and call channels cannot be cleared.
- ④ Push any switch to stop the flashing.

NOTE:
Be careful—the contents of cleared memories CANNOT be recalled.
• Scan edge channels 1A/1b cannot be cleared.

 Memory clearing may not be performed from the microphone.

[EXAMPLE]: Clearing memory channel 20.

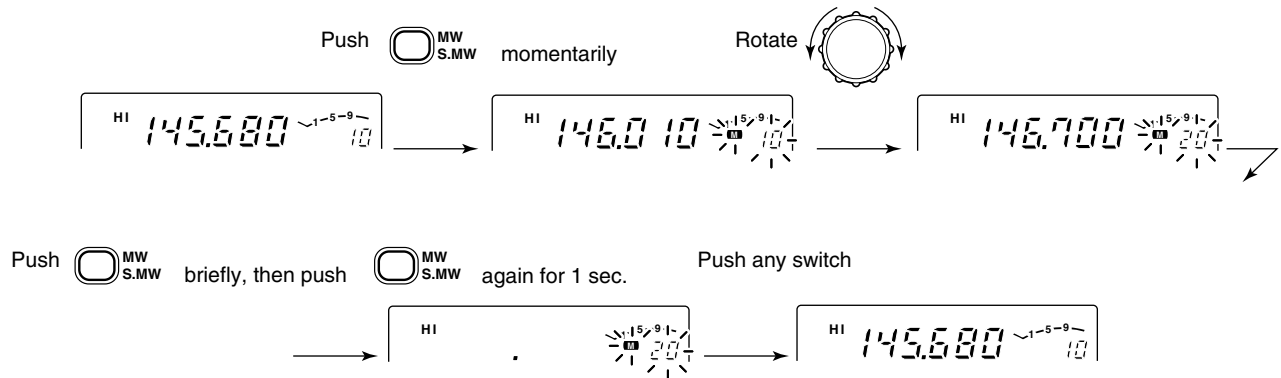

■ Calling up a call channel

Each band has an independent call channel to store a most-often-used frequency for quick recall.

- ① Push [BAND] one or more times to select a band, if necessary.
- ② Push [M/CALL] once or twice to display a large “C” in the memory channel readout.
 - While a call channel is displayed, pushing [BAND] toggles between the 2 call channels.

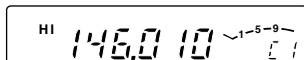

Large “C” shows a call channel is selected.

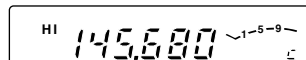

Small “c” shows VFO mode was selected from a call channel.

- ③ Push [V/MHz] or [M/CALL] to exit the call channel.



- ① Push [BAND] to select the desired band, if necessary.
- ② Push [(MR)CALL] for 1 sec. to select the call channel.
- ③ Push [BAND] to toggle between the 2 call channels.

■ Transferring call channel contents

- ① Push [BAND] to select a band, if necessary.
- ② Select the call channel by pushing [M/CALL] once or twice.
 - “C1” or “C2” appears—push [BAND] to toggle between them.
- ③ Push [S.MW] momentarily, then rotate the tuning dial to select another memory channel to transfer.
 - To transfer to the VFO, push and hold [(S.MW)MW] instead of pushing momentarily.
- ④ Push and hold [(S.MW)MW] to transfer when a momentary push was used in the previous step.



- ① Push [BAND] to select the desired band, if necessary.
- ② Push [(MR)CALL] for 1 sec. to select a call channel, then push [BAND] to select the other call channel, if desired.
- ③ Push [FUNC], then [ⓂMW] momentarily.
 - To transfer to the VFO, push [FUNC] then [ⓂMW] instead of pushing [ⓂMW] momentarily.
- ④ Push [FUNC] then [ⓂMW] for 1 sec. to transfer when momentarily pushing [ⓂMW] in step ③.

■ Programming a call channel

In addition to an operating frequency, duplex information and subaudible tone information (tone encoder or tone squelch ON/OFF and its frequency) can be programmed into a call channel.

- ① Push [BAND] to select a band, if necessary.
- ② Select the call channel by pushing [M/CALL] once or twice. ("C1" or "C2" appears); then push [BAND] to change the call channel, if desired.
- ③ Set the desired frequency in VFO mode:
 - ➔ Push [VFO] to select VFO mode.
 - ➔ Set the frequency using the keypad.
 - ➔ Set other data (e.g. offset frequency, duplex direction, subaudible tone encoder ON/OFF and its frequency), if required.
- ④ Push [(S.MW)MW] for 1 sec. to program.

✓ CONVENIENT

The call channel can also be programmed from the VFO directly (similar to memory programming).

MW
A

- ① Push [BAND] to select the desired band, if necessary.
- ② Push [(MR)CALL] for 1 sec. to select a call channel, then push [BAND] to change the call channel, if desired.
- ③ Set the desired frequency in VFO mode:
 - Push [VFO] to select VFO mode.
 - Set the desired frequency using the keypad.
 - Set other data, if required.
- ④ Push [FUNC] then [ⓂMW] for 1 sec. to program.

[EXAMPLE]: Programming 145.120 MHz into the VHF call channel via the microphone.

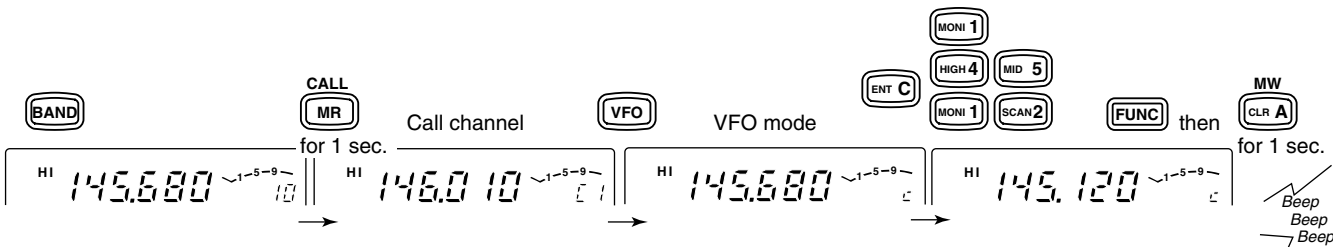

■ What is a scratch pad memory?

During VFO operation, the transceiver automatically memorizes operating frequency information, separate from regular memory channels, when transmitting on a new frequency. The 5 previously operated frequencies for each band can be recalled (L1 to L5 appear for simplex frequencies; r1 to r5 appear for duplex frequencies).

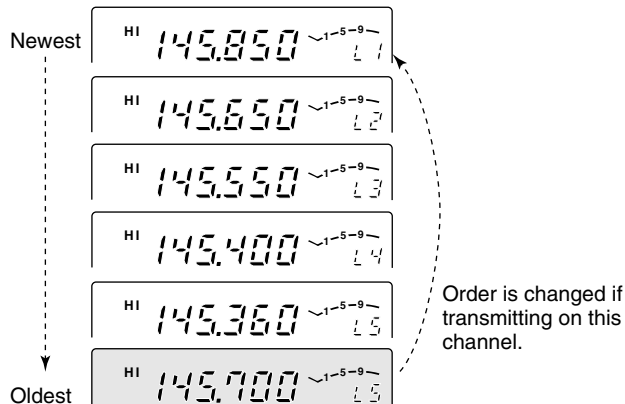

The oldest written frequency is cleared.

NOTE: When memory mode is selected, the frequency is not programmed into a scratch pad.

■ Calling up a scratch pad memory

- ① Select the call channel by pushing [M/CALL] once or twice. (A large “C” appears.)
 - To transmit on the scratch pad memory, select the desired band in advance.
- ② Rotate the tuning dial to select a scratch pad memory.
 - Previously transmitted frequency and one of “L1–L5” appears for simplex memories (rotate [DIAL] left); one of “r1–r2” appears for duplex memories (rotate [DIAL] right).
 - When first applying power or after CPU resetting, scratch pad memories contain no data and therefore cannot be accessed.
- ③ Push [V/MHz] or [M/CALL] to exit the scratch pad memory.

- The 5th scratch pad memory will be cleared when transmitting on a new frequency. If the transmit frequency is already stored in a scratch pad memory, the scratch pad memory is not cleared but the order is changed.
- When transmitting on a scratch pad memory, the scratch pad memory becomes the 1st scratch pad memory and the order is changed.

8 SCRATCH PAD MEMORY



- 1 Push [BAND] to select the desired band, if necessary.
- 2 Push and hold [(MR)CALL] to select a call channel.
 - A large “C” appears.
- 3 Push [▼] one or more times to select a duplex scratch pad memory.
 - Once entering a scratch pad memory, [▲] can also be used for selection.
- 4 Push [MR] or [VFO] to exit the scratch pad memory.

■ Transferring scratch pad memory contents

Transferring scratch pad memory contents to the VFO is done similarly to transferring regular memory/call channel contents.

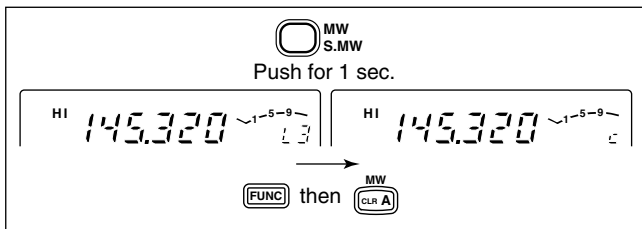

- 1 Push [BAND] to select a band, if necessary.
- 2 Select a call channel by pushing [M/CALL] once or twice.
 - A large “C” appears.
- 3 Rotate the tuning dial to select the desired scratch pad memory.
 - One of “L1”–“L5” appears.
- 4 Push [(S.MW)MW] momentarily.
 - “M - - ” flashes to indicate VFO as the transferring channel.
- 5 Rotate the tuning dial to select the desired memory channel if required.
- 6 Push and hold [(S.MW)MW] to transfer.



- 1 Push [BAND] to select the desired band, if necessary.
- 2 Push [(MR)CALL] for 1 sec. to select the call channel.
- 3 Push [▼] one or more times to select the desired scratch pad memory.
- 4 Push [FUNC] then [▲MW] momentarily.
 - “M - - ” flashes to indicate VFO as the transferring channel.
- 5 Push [▲] or [▼] to select the desired memory channel if required.
- 6 Push [FUNC] then [▲MW] for 1 sec. to transfer.

■ Scan types

Scanning searches for transmitted signals automatically and makes it easier to locate new stations for contact or listening purposes.

Each band has 3 scan types and 5 resume conditions to suit your needs.

FULL SCAN

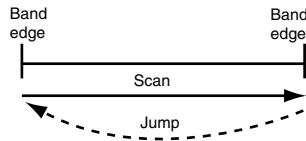

Repeatedly scans all frequencies over the entire band. Used as the simplest scan without any preliminary settings necessary.

PROGRAMMED SCAN

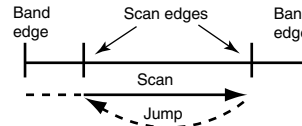

Repeatedly scans between two user-programmed frequencies. Used for checking for frequencies within a specified range such as repeater output frequencies, etc. 5 pairs of scan edges are available.

MEMORY SCAN

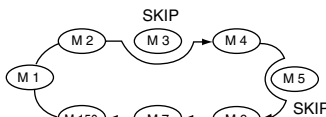

Repeatedly scans memory channels except for skip channels. Used for often-called channels and bypassing normally busy channels such as repeater frequencies.

SCAN RESUME CONDITION

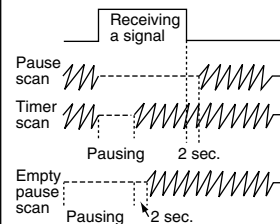

5 resume conditions are available: 3 timer scans, pause scan and empty scan. When receiving a signal, pause scan pauses until the signal disappears; timer scans pause for 5, 10 or 15 sec. Empty pause scan pauses until a signal appears.

9 SCAN OPERATION

■ Scan start/stop

◇ Pre-operation

- Common setting: scan resume condition. (p. 43)
- For programmed scan: program the scan edges. (p. 40)
- For memory scan: program 2 or more memory channels; set memory skip settings, if desired. (p. 42)

◇ Operation

- ① Push [BAND] to select a band, if necessary.
- ② Select VFO mode for full/programmed scan with the [V/MHz] switch; or memory mode for memory scan with the [M/CALL] switch.
- ③ Set the squelch to the point where noise is muted.
- ④ Push **[SCAN]** for 1 sec. to start the scan.
 - When the tone squelch is in use, **[SCAN]** starts a normal scan—not tone scan.
 - To change the scanning direction, rotate the tuning dial.
 - The memory channel readout indicates the scan type as follows:

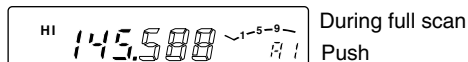

to select full scans and scan edge pairs in sequence.

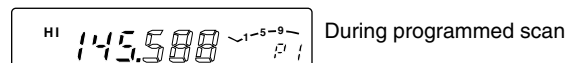

- ↑ Indicates scan edge channels.
- P1 stands for 1A/1b.
 - P1 to P5 are available when they are programmed.

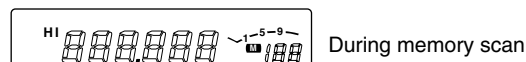

- ⑤ To select the scan range while operating full/programmed scan, push [BAND] several times.
- ⑥ To stop the scan, push [VMHz].



- ① Push [BAND] to select the desired band, if necessary.
- ② Push [VFO] to select VFO mode for full/programmed scan; or push [MR] to select memory mode for memory scan.
- ③ Push [⓪▲SQL] or [Ⓜ▼SQL] one or more times to set the squelch just closed.
- ④ Push [③SCAN] to start the scan.



- [▲]/[▼] also start the scan when pushed and held.
- ⑤ To select the scan range while operating full/programmed scan, push [BAND] several times.
 - ⑥ To stop the scan push [ⒶCLR].

■ Programming scan edges

Scan edges can be programmed in the same manner as memory channels. Scan edges are programmed into pairs of scan edge channels, 1A/1b to 5A/5b, in memory channels.

- ① Push [BAND] to select a band, if necessary.
- ② Set the desired frequency in VFO mode:
 - ➔ Push [V/MHz] to select VFO mode.
 - ➔ Set the frequency using the tuning dial.
 - ➔ Set other data (e.g. offset frequency, etc.) if required.
- ③ Push [S.MW] momentarily.
 - “[M]” and the memory channel number flashes.

- ④ Rotate the tuning dial to select a scan edge channel (1A to 5A).
- ⑤ Push [(S.MW)MW] for 1 sec. to program.
 - 3 beeps may sound and the frequency is programmed.
 - Scan edge “x”b is automatically selected when continuing to push [(S.MW)MW] after programming.
- ⑥ To program a frequency for the other pair of scan edges, 1b to 5b, repeat steps ③ to ⑤.
 - If the same frequency is programmed into both scan edges, programmed scan will not function.

[EXAMPLE]: Programming 145.30 MHz and 145.80 MHz for the VHF scan edges 1A and 1b.

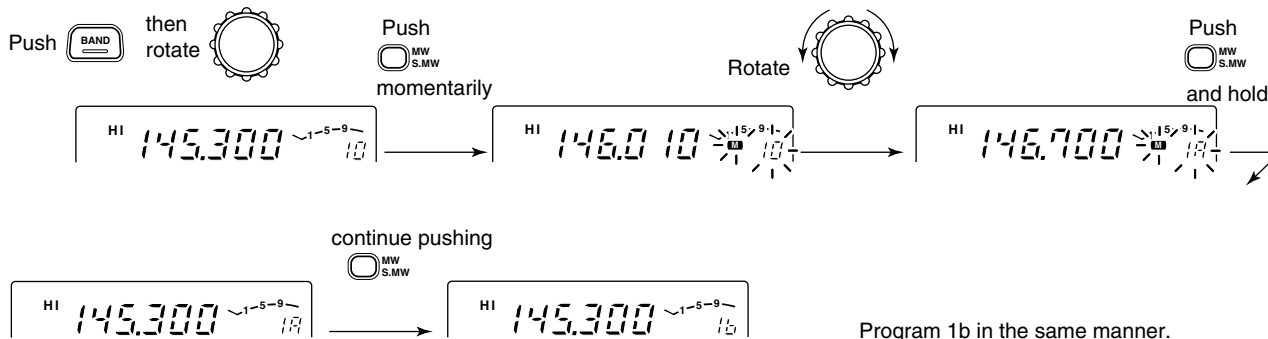

9 SCAN OPERATION

■ Programming scan edges via the microphone

MW
A

- 1 Push [BAND] to select the desired band, if necessary.
- 2 Set the desired frequency in VFO mode:
 - Push [VFO] to select VFO mode.
 - Set the frequency using the keypad.
- 3 Push [FUNC] then [Ⓜ] momentarily.
- 4 Push [▲] or [▼] to select scan edge channels.
- 5 Push [FUNC] then [Ⓜ] for 1 sec. to program.

- 3 beeps may sound and the VFO contents (including the sub-audible tone frequency, etc.) are programmed.
 - Memory channel number advances to the next scan edge channel (1b to 5b) when continuing to push [Ⓜ] after programming.
- 6 To program a frequency for the other scan edge channel, repeat steps 2 and 5.

[EXAMPLE]: Programming 145.30 MHz and 145.80 MHz for the VHF scan edges 1A and 1b.

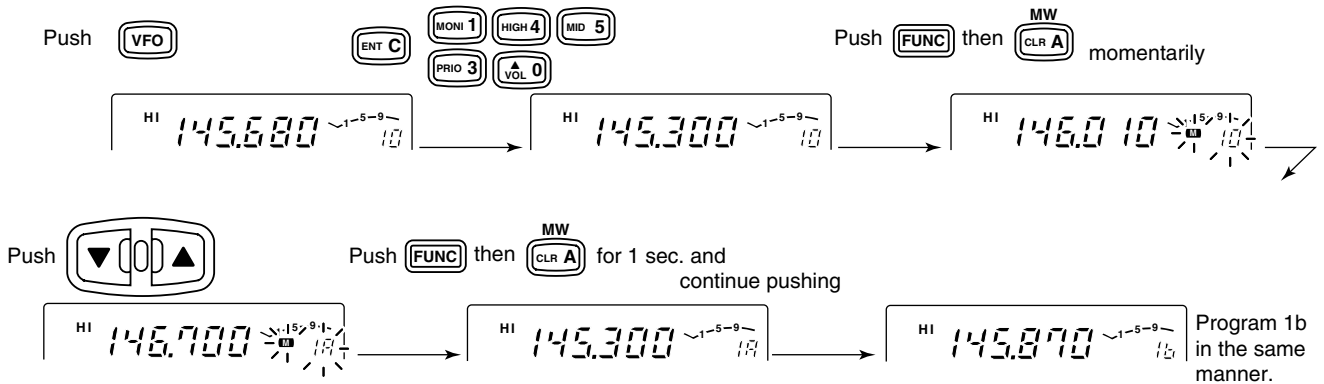

■ Skip channel setting

USING SET MODE

The memory skip function speeds up scanning by checking only desired memory channels. Set the memory channels to be skipped or scanned as follows.

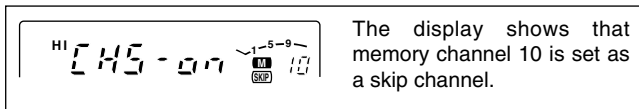

- ① Push [BAND] to select the a band, if necessary.
- ② Select the memory channel to program or to cancel the skip function on:
 - ➔ Select memory mode by pushing [M/CALL] once or twice.
 - ➔ Rotate the tuning dial to select the memory channel.
- ③ Push [SET] one or more times until “CHS” appears as shown above.
 - Pushing [MONI] reverses the order of selection.
- ④ Rotate the tuning dial to turn the skip function ON or OFF on the selected channel.
 - “**SKIP**” appears : The memory channel is skipped during (CHS-on) memory scan.
 - “**SKIP**” disappears : The memory channel is scanned during (CHS-OFF) memory scan.
- ⑤ Push [V/MHz] to exit set mode.

NOTE: Scan edge memory channels cannot be specified as skip channels, however, they are skipped during memory scan anyway.

SET
B

- ① Push [BAND] to select the desired band, if necessary.
- ② Select the memory channel to program or to cancel the skip function on:
 - ➔ Select memory mode by pushing [MR].
 - ➔ Push [▲] or [▼] to select a memory channel.
- ③ Push [ⓑSET] one or more times until “CHS” appears as shown at left.
 - Pushing [ⓐENT] reverses the order of selection once entering set mode.
- ④ Push [▲] or [▼] to set or cancel the skip information.
 - See item ④ at left for skip indicator details.
- ⑤ Push [ⒶCLR] to exit set mode.

9 SCAN OPERATION

■ Scan resume condition

USING SET MODE

The scan resume condition can be selected as timer, pause or empty pause scan. The empty pause scan is useful for finding unused frequencies. The selected resume condition is also used for priority watch. (p. 44)

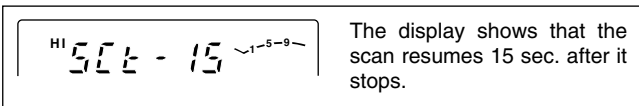

- ① Push [BAND] to select a band, if necessary.
- ② Push [SET] one or more times until “SCt” or “SCP” appears as shown above.
 - Pushing [MONI] reverses the order of selection.
 - Cancel the DTMF memory encoder in advance. (p. 48)
- ③ Rotate the tuning dial to set the desired timer.
 - “SCt-15” : Scan pauses 15 sec. while receiving a signal.
 - “SCt-10” : Scan pauses 10 sec. while receiving a signal.
 - “SCt-5” : Scan pauses 5 sec. while receiving a signal.
 - “SCP-2” : Scan pauses until the signal disappears and then resumes 2 sec. thereafter.
 - “SCt-EP” : Scan pauses on a frequency that is not busy and resumes 2 sec. after a signal appears.
- ④ Push [V/MHz] to exit set mode.



- ① Push [BAND] to select the desired band, if necessary.
- ② Push [ⓂSET] one or more times until “SCt” or “SCP” appears as shown at left.
 - Pushing [ⓂENT] reverses the order of selection once entering set mode.
 - Cancel the DTMF memory encoder in advance. (p. 48)
- ③ Push [▲] or [▼] to select the scan resume condition.
 - See item ③ above for scan resume condition details.
- ④ Push [ⓂCLR] to exit set mode.

Priority watch types

Priority watch checks for signals on a memory or call channel every 5 sec. while operating on a VFO frequency. The transceiver has 3 priority watch types to suit your needs. You can transmit on the VFO frequency while the priority watch operates.

The watch resumes according to the selected scan resume condition. See previous page for details.

NOTE:

- Priority watch cannot be started from a scratch pad memory.
- The DTMF memory encoder is turned OFF when priority watch starts.
- If the pocket beep function is activated, the transceiver automatically selects the tone squelch function when priority watch starts.
- When "SCt-EP" is selected for the scan resume condition, the priority watch pauses on a no-signal channel. (p. 43)

MEMORY CHANNEL WATCH

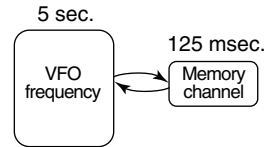

While operating on a VFO frequency, priority watch checks for a signal on the selected memory channel every 5 sec.

- A memory channel with skip information can be watched.

MEMORY SCAN WATCH

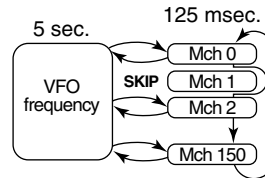

While operating on a VFO frequency, priority watch checks for signals on each memory channel in sequence.

- The memory skip function and memory area setting are useful to speed up the scan.

CALL CHANNEL WATCH

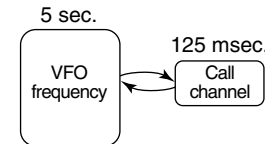

While operating on a VFO frequency, priority watch checks for a signal on the call channel every 5 sec.

■ Priority watch operation

- ① Push [BAND] to select a band, if necessary.
- ② Select VFO mode; then, set an operating frequency.
- ③ Set the watching channel(s).

For memory channel watch:

Select the desired memory channel.

For memory scan watch:

Select memory mode; then, push **[SCAN]** for 1 sec. to start memory scan.

For call channel watch:

Select the call channel by pushing [M/CALL] once or twice.

- ④ Push **[PRIO]** for 1 sec. to start the watch.
 - The transceiver checks the memory or call channel frequency every 5 sec.
 - The watch resumes according to the selected scan resume condition. (p. 43)
 - While the watch is pausing, pushing the selected band's [M/CALL] resumes the watch manually.
- ⑤ Push [M/CALL] while the display shows the VFO frequency to stop the watch.

While pausing on the memory or call channel, "PRIO" flashes.

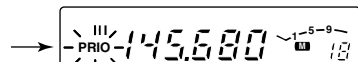

- ① Push [BAND] to select the desired band, if necessary.
- ② Select VFO mode; then, set an operating frequency.
- ③ Set the watching channel(s).

For memory channel watch:

Push [MR] then [▲] or [▼] to select the desired memory channel.

For memory scan watch:

Push [MR] then [②SCAN] to start the memory scan.

For call channel watch:

Push and hold [(MR)CALL] to select the call channel.

- ④ Push [③PRIO] to start the watch.
 - The transceiver checks the memory or call channel frequency every 5 sec.
 - The watch resumes according to the selected scan resume condition. (p. 43)
 - To resume the watch manually while pausing, push [③PRIO] or [ⒶCLR].
- ⑤ To stop the watch, push [ⒶCLR] once (or twice while watch pauses).

■ Programming a DTMF code

DTMF codes are used for autopatching, accessing repeaters, controlling other equipment, etc. The transceiver has 14 DTMF memory channels (d0–d9, dA–dd) for storage of often-used DTMF codes of up to 16 digits.

NOTE: DTMF memory channels are commonly used for both bands. Therefore, programming each band is not necessary.

- ① Push **DTMF** for one sec. and “d” appears in place of the 100 MHz digit as shown below.

“d” appears in place of the 100 MHz digit.

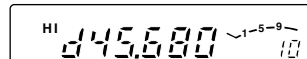

- ② Push [SET] to enter the programming condition.
- ③ Rotate the tuning dial to select the desired channel.
- ④ Push [SET] or [MONI] to select the cursor.
- ⑤ Rotate the dial to select a digit.
 - “E” stands for “*” and “F” stands for “#.”
- ⑥ Repeat steps ④ and ⑤ until the last digit is entered.
 - The S/Rf indicator shows the digit group. The indication increases every 6 digits.
 - Select “-” to clear the remaining digits when programming over a previously used memory channel.
- ⑦ Push [V/MHz] exit the programming condition.

■ Clearing the DTMF memory contents

- ① Push **DTMF** for 1 sec. to turn the DTMF memory encoder ON.
- ② Push [SET] to enter the programming condition.
- ③ Rotate the tuning dial to select the desired channel.
- ④ Push [SET] to activate the 1st digit.
- ⑤ Rotate the tuning dial to select “-” and clear the memory channel contents.
- ⑥ Push the tuning dial to exit the programming condition.

11 DTMF MEMORY ENCODER

■ Programming a DTMF code via the microphone



DTMF codes can be directly programmed via the keypad on the microphone. The contents can be overwritten, but cannot be cleared via the microphone. See the previous page for clearing the contents.

- 1 Push [FUNC] then [DTMF] to turn the DTMF memory function ON.
 - “d” appears in place of the 100 MHz digit.
- 2 Push [SET] to enter the programming condition.

- 3 Push [▲] or [▼] to select the desired channel.

- 4 Push the desired digit keys.

- When the first digit is input, previous memory contents are cleared automatically.
- “E” stands for “*” and “F” stands for “#.”
- Push [▲] then [▼], and repeat this step when making a mistake.
- The S/R/F indicator shows the digit group. The indication increases every 6 digits.

- 5 Push [BAND] to exit the programming condition.

- The [CLR] key cannot be used to exit. If pushed, “A” is input, and the previously programmed data is erased. Reprogram again in such a case.

[EXAMPLE]: Programming “5428AB453” into DTMF memory channel “d4.”

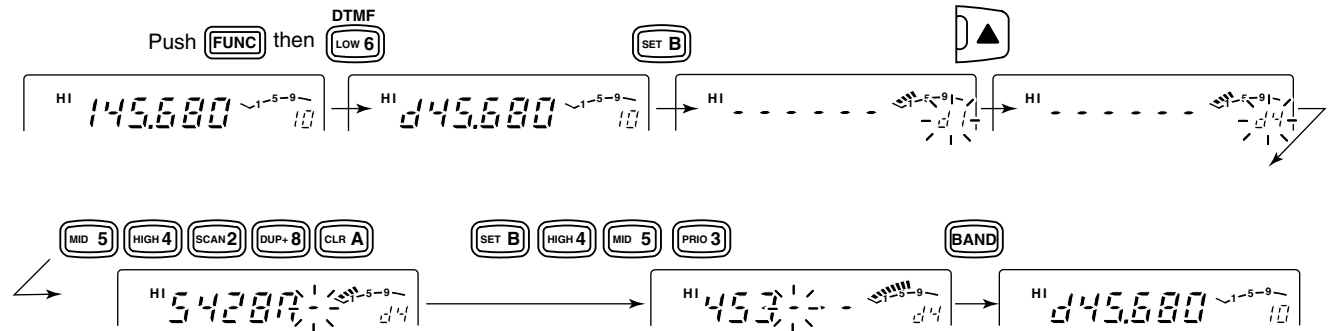

■ Transmitting a DTMF code

◇ Using the DTMF memory function (automatic transmission)

The selected DTMF code is transmitted at each push of the PTT switch when the DTMF memory encoder is turned ON.

- ① Push **DTMF** for 1 sec. to turn the DTMF memory encoder ON.
 - “d” appears in place of the 100 MHz digit.
- ② Push [SET] to enter the programming condition.
- ③ Rotate the tuning dial to select the desired DTMF memory channel.
- ④ Push [PTT] to transmit the selected DTMF code.
 - At each push of [PTT], the selected DTMF code is transmitted.
 - The speaker emits the DTMF tones sent.
- ⑤ Push **DTMF** for 1 sec. to cancel the function.
 - “d” disappears.



- ① Push [FUNC] then [ⓄDTMF] to turn the DTMF memory encoder ON.
 - “d” appears in place of the 100 MHz digit.
- ② Push [ⓄSET] to enter the programming condition.
- ③ Push [▲] or [▼] to select the desired channel.
- ④ Push [PTT] to transmit the selected DTMF code.
 - Each push of [PTT], transmits the DTMF code.
- ⑤ Push [ⓄCLR] to cancel the function.

◇ Transmitting a DTMF memory channel directly



- ① Push [FUNC] then [ⓄDTMF] to turn the DTMF memory encoder ON.
 - “d” appears in place of the 100 MHz digit.
- ② Push [DTMF-S], then push the desired DTMF channel number.
 - “0” to “9” and “A” to “D” are available for channel numbers.
- ③ Push [DTMF-S] again to deactivate the DTMF setting.
- ④ Push [ⓄCLR] to turn the DTMF memory encoder OFF.
 - When the DTMF memory encoder is turned ON continuously, each push of the PTT transmits the previously selected DTMF code.

11 DTMF MEMORY ENCODER

■ DTMF speed

USING INITIAL SET MODE

The rate at which DTMF memories send individual DTMF characters can be set to accommodate operating needs.



- ① Push [PWR] to turn power OFF.
- ② While pushing [SET] (far right switch), push [PWR] for 1 sec. to turn power ON and enter initial set mode.
- ③ Push [SET] or [MONI] to select the “dtd” display as shown above.
- ④ Rotate the tuning dial to select the desired speed as shown in the table below.
- ⑤ Push [PWR] momentarily to exit initial set mode.

DISPLAY	INTERVAL	SPEED
dtd-1	100 msec.	5.0 cps
dtd-2	200 msec.	2.5 cps
dtd-3	300 msec.	1.6 cps
dtd-5	500 msec.	1.0 cps

cps=
characters/second

■ Pocket beep operation

This function uses subaudible tones for calling and can be used as a “common pager” to inform you that someone has called while you were away from the transceiver.

◇ Waiting for a call from a specific station

- ① Push [BAND] to select a band, if necessary.
- ② Set the operating frequency.
- ③ Program the subaudible tone frequency in set mode.
 - See p. 26 for programming details.
- ④ Push [TONE] one or more times to indicate “T SQL ((•))” in the function display.
- ⑤ When a signal with the correct tone is received, the transceiver emits beep tones and flashes “((•))”.
 - Beep tones sound for 30 sec. To stop the beeps manually, push the tuning dial (or any key).
 - “((•))” flashes continuously until step ⑥ or ⑦.
 - When receiving another call while “((•))” is flashing, no beeps sound.
- ⑥ Push [PTT] to answer.
 - Tone squelch is automatically selected when transmitting.
- ⑦ Push [TONE] once or twice to cancel the function.

SQL ((•))
8

- ① Push [BAND] to select the desired band, if necessary.
- ② Set the operating frequency.
- ③ Program the subaudible tone frequency in set mode.
 - See p. 26 for programming details.
- ④ Push [FUNC] then [Ⓢ T SQL ((•))] to turn the pocket beep ON.
- ⑤ When a signal with the correct tone is received, the transceiver emits beep tones for 30 sec. and flashes “((•)).”
- ⑥ Push [PTT] to answer or push [Ⓜ CLR] to stop the beeps and flashing.
 - Tone squelch is automatically selected.
 - Pushing [FUNC] then [Ⓢ TSQL] also selects the tone squelch.
- ⑦ To cancel the function, push [FUNC] then [Ⓢ T-OFF].

T-OFF
C

◇ Calling a waiting station using pocket beep

A subaudible tone matched with the stations frequency is necessary. Use the tone squelch on the next page or a subaudible tone encoder (pgs. 24, 25).

■ Tone squelch operation

The tone squelch opens only when receiving a signal with the same pre-programmed subaudible tone.

- ① Push [BAND] to select a band, if necessary.
- ② Set the operating frequency.
- ③ Program the subaudible tone frequency in set mode.
 - See p. 26 for programming details.
- ④ Push [TONE] one or more times until “T SQL” appears in the function display.
- ⑤ When the received signal includes the correct tone, the squelch opens and the signal can be heard.
 - When the received signal includes an incorrect tone, the squelch does not open. However, the S/RF indicator shows the received signal strength.
 - To open the squelch manually, push [MONI].
- ⑥ Operate the transceiver in the normal way (push [PTT] to transmit; release [PTT] to receive).
- ⑦ To cancel the tone squelch, push [TONE].
 - “T SQL” disappears from the function display.

T SQL
9

- ① Push [BAND] to select the desired band, if necessary.
- ② Set the operating frequency.
- ③ Program the subaudible tone frequency in set mode.
 - See p. 26 for programming details.
- ④ Push [FUNC] then [9T SQL] to turn the tone squelch ON.
- ⑤ When the received signal includes the correct tone, the squelch opens and the signal can be heard.
 - When the received signal includes an incorrect tone, the squelch does not open. However, the S/RF indicator shows the received signal strength.
 - To open the squelch manually, push [MONI].
- ⑥ Operate the transceiver in the normal way (push [PTT] to transmit; release [PTT] to receive).
- ⑦ To cancel the tone squelch, push [FUNC] then [©T-OFF].

T-OFF
C

■ Tone scan

By monitoring a signal that is being transmitted on a repeater input frequency, you can determine the tone frequency necessary to open a repeater.

- ① Push [BAND] to select a band, if necessary.
- ② Set the desired frequency to be checked for a tone frequency e.g. repeater input frequency.
- ③ Push **T-SCAN** for 1 sec. to start the tone scan.
 - To change the scanning direction, rotate the tuning dial.
- ④ When the tone frequency is matched, the squelch opens and the tone frequency is programmed into the selected mode such as VFO, memory/call channel or scratch pad memory.
 - The tone scan pauses when a tone frequency is detected.
 - The decoded tone frequency is used for the tone encoder or tone decoder/decoder depending on the tone squelch ON/OFF setting.
- ⑤ Push [V/MHz] to stop the scan.

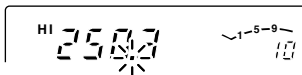

- ① Push [BAND] to select the desired band, if necessary.
- ② Set the desired frequency to be checked for a tone frequency e.g. repeater input frequency.
- ③ Push [F-2] to start the tone scan.
- ④ When the tone frequency is matched, the squelch opens and the tone frequency is programmed into the selected mode such as VFO, memory/call channel or scratch pad memory.
- ⑤ Push [A CLR] to stop the scan.

NOTE: The decoded tone frequency is programmed temporarily when a memory or call channel is selected. However, this will be cleared when overwriting the memory/call channel.

13 WIRELESS OPERATION

optional EX-1759 and HM-90

■ Connection

Wireless remote control is available when the following options are used:

- HM-90 WIRELESS MICROPHONE
- EX-1759 INFRARED RECEIVER

◇ Recommended connection

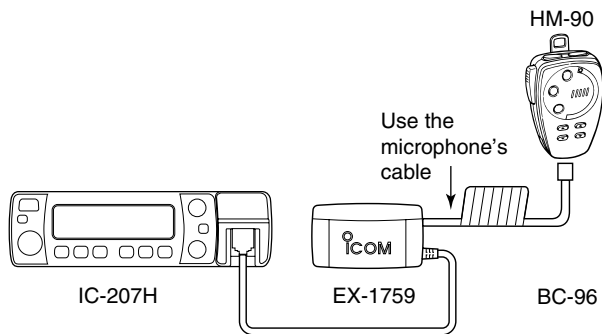

■ HM-90 WIRELESS MICROPHONE

The HM-90's internal battery should be charged when the microphone is not being held.

Charging period: 1.5 hrs. with timer

(or 8 hrs. when battery is exhausted)

Operating period: 12 hrs (Operation : standby= 1 : 4)

◇ Charging method

Choose one of the following methods:

- ➔ Connect the cable from the HM-90 to the EX-1759.

◇ Turning the wireless remote ON/OFF

When you use the HM-90 as a wired microphone, the wireless remote control circuit can be turned OFF.

The diagram shows that the wireless remote control function is turned ON.

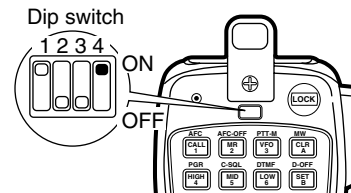

■ EX-1759 installation

The EX-1759 INFRARED RECEIVER can be installed for 2 different purposes depending on the HM-90 charger. This is because the EX-1759 has both an infrared receiver and a microphone connector which contains microphone charging capabilities.

• When using the connector for a microphone charger

Attach the EX-1759 to a suitable location for receiving infrared signals and where it can be connected to a cable, e.g. the console, etc.

/// **NOTE:** DO NOT attach the EX-1759 where it will be subject to direct sunlight as it cannot detect infrared signals under such conditions.

• Optional infrared sub receiver

An optional EX-1513 INFRARED SUB RECEIVER is available to increase the remote control reliability and extend the controllable area. Connect the EX-1513 to the inside connector of the EX-1759.

/// **NOTE:** The supplied microphone, HM-98, can be connected and used with the EX-1759, however, the optional wireless microphone cannot be used in such a case.

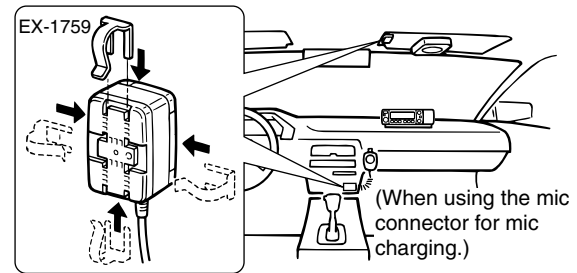

The installation clip can be oriented in 1 of 4 ways.

13 WIRELESS OPERATION

■ HM-90 switches

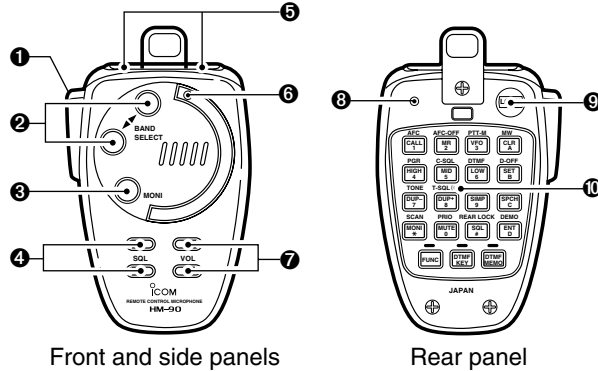

Front and side panels

Rear panel

1 PTT SWITCH

- ➔ Push and hold to transmit; release to receive.
- ➔ Toggles between transmitting and receiving while the one-touch PTT function is in use.

2 BAND SWITCHES [BAND SELECT ▲, ▼]

Select a band.

3 MONITOR SWITCH [MONI]

Toggles between opening and closing the squelch.

4 SQUELCH LEVEL UP/DOWN SWITCHES

[▲SQL], [▼SQL]

Vary the squelch threshold point for noise mute.

5 FREQUENCY UP/DOWN SWITCHES [UP], [DN]

- ➔ Push either switch to change the operating frequency, memory channel, set mode contents, etc.
- ➔ Push and hold either switch to start scanning.

6 ACTIVITY INDICATOR

Lights red while a key is pushed; lights green while the one-touch PTT function is in use.

7 AUDIO VOLUME UP/DOWN SWITCHES [▲VOL], [▼VOL]

Adjust the accessed band's audio level.

8 MODE INDICATOR

Indicates the microphone condition.

- Lights red when [FUNC] is pushed.
- Lights green when [DTMF KEY] is pushed.
- Lights orange when [DTMF MEMO] is pushed.

9 LOCK SWITCH [LOCK]















Locks all switches and keys on the microphone except for the PTT switch.

10 KEYPAD









Used for controlling the transceiver, transmitting a DTMF memory channel, etc.

Downloaded by
RadioAmateur.EU

◇ Keypad

KEY	FUNCTION	SECONDARY FUNCTION (After )	OTHER FUNCTIONS
	Calls up a call channel.	No secondary function.	<p>• After  : Input the appropriate digit for frequency or memory channel selection.</p> <p>• After  : Transmit the appropriate DTMF code.</p> <p>• After  : Transmit the appropriate DTMF memory contents. [0] to [9], [A] to [D] can be used for DTMF memory.</p>
	Selects memory mode.	No secondary function.	
	Selects VFO mode.	Turns the one-touch PTT function ON and OFF.	
	Selects high output power.	No secondary function.	
	Selects mid-high output power.	No secondary function.	
	Selects low output power.	Turns the DTMF memory function ON.	
	Selects – duplex.	Turns the subaudible tone encoder ON.	
	Selects + duplex.	Turns the pocket beep function ON.	
	Selects simplex.	Turns the tone squelch function ON.	
	Mutes audio signals.	Starts and stops a priority watch.	

13 WIRELESS OPERATION

KEY	FUNCTION	SECONDARY FUNCTION (After )	OTHER FUNCTIONS
MW 	Clears a digit before entry. Cancels the scan, priority watch, or DTMF memory function.	Writes the VFO contents into the memory channel or call channel. Advances the memory channel number when continuously pushed after programming is completed.	 : • After  : Transmit the appropriate DTMF code. [⊛MONI] Transmits a 1750 Hz tone call signal for 0.5 sec. [⊛SQL] Transmits a 1750 Hz tone call signal while pushing.
D-OFF 	Enters set mode and advances the set mode selection order.	Turns the DTMF memory function OFF.	
T-OFF 	Decreases the set mode selection order after entering set mode. NOTE: The IC-207H has no voice synthesizer function.	Turns the subaudible tone encoder, pocket beep or tone squelch OFF.	
DEMO 	Sets the keypad for numeral input.	Enters and exits demonstration mode.	
SCAN 	Toggles between opening and closing the squelch.	Starts and stops scanning.	
REAR LOCK 	Selects 1 of the 4 preset squelch levels.	Locks all the keys on the microphone keypad.	

■ Microphone address

USING INITIAL SET MODE

The transceiver has 8 possible microphone addresses (including OFF) to help prevent interference from other HM-90 WIRELESS MICROPHONES. Set both the microphone address and microphone dip switch to the same value as follows.

NOTE: When the supplied microphone is connected, the transceiver rejects control signals from the HM-90 even when the microphone address is matched.

◇ Microphone address

- ① Push [PWR] to turn power OFF.
- ② While pushing [SET], turn power ON to enter initial set mode.
- ③ Push [SET] a few times to select the “Adr” display as shown at right.

Adr - 2

The display shows the microphone address is set to 2.
- ④ Rotate the tuning dial to set the microphone address to 0–7 or to turn the microphone control OFF.
 - When “Adr-oF” is selected, the transceiver rejects all control signals from the HM-90.
- ⑤ Push [PWR] momentarily to exit initial set mode.

◇ Microphone dip switch

- ① Remove the switch cover from the microphone rear panel.
- ② Set the microphone dip switch and the microphone address to the same value as shown below.
- ③ Replace the switch cover.

MICROPHONE ADDRESS	DIP SWITCH		
	S1-1	S1-2	S1-3
Adr-0	OFF	OFF	OFF
Adr-1 (default)	ON	OFF	OFF
Adr-2	OFF	ON	OFF
Adr-3	ON	ON	OFF
Adr-4	OFF	OFF	ON
Adr-5	ON	OFF	ON
Adr-6	OFF	ON	ON
Adr-7	ON	ON	ON

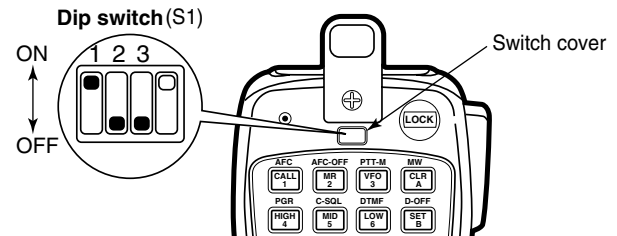

14 OTHER FUNCTIONS

■ Beep tones on/off USING INITIAL SET MODE

You can select silent operation by turning beep tones OFF or you can select to have confirmation beeps sound at the push of a switch by turning beep tones ON.

- ① Push [PWR] to turn power OFF.
- ② While pushing [SET], turn power ON to enter initial set mode.
- ③ Push [SET] one or more times until “bEP” appears.
 - Pushing [MONI] reverses the order of selection.
- ④ Rotate the tuning dial to select the condition.
 - “bEP-oF”: Beep tones are turned OFF.
 - “bEP-on”: Beep tones are turned ON.
- ⑤ Push [PWR] momentarily to exit initial set mode.

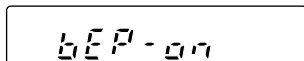

The display shows that the beep tones are turned ON.

■ Time-out timer USING INITIAL SET MODE

To prevent accidental prolonged transmission with the one-touch PTT function, etc., the transceiver has a time-out timer. This timer cuts a transmission OFF after 3, 5, 15 or 30 min. of continuous transmission. This timer can be cancelled (default).

Approx. 10 sec. before the time-out timer passes, the transceiver emits a beep tone as a warning.

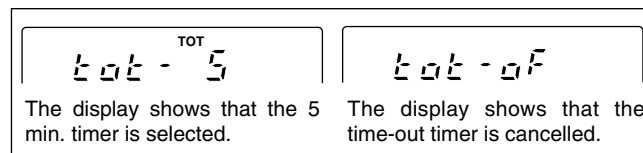

The display shows that the 5 min. timer is selected.

The display shows that the time-out timer is cancelled.

- ① Push [PWR] to turn power OFF.
- ② While pushing [SET], turn power ON to enter initial set mode.
- ③ Push [SET] one or more times until “tot” appears.
 - Pushing [MONI] reverses the order of selection.
- ④ Rotate the tuning dial to select the desired time-out time or turn the timer OFF (“oF”).
- ⑤ Push [PWR] momentarily to exit initial set mode.

■ Auto power-off

USING INITIAL SET MODE

The auto power-off function conveniently turns the transceiver power OFF after a preset time in which no operations are performed. In this way, when you forget to turn the power OFF, the transceiver automatically turns itself OFF, thereby conserving battery power.

The time can be set to 30 min., 1 hr., 2 hrs. or turned OFF. The selected time is retained even when the transceiver is turned OFF via the auto power-off function. To cancel the function, select “oF” in step ④ below.

- ① Push [PWR] to turn power OFF.
- ② While pushing [SET], turn power ON to enter initial set mode.
- ③ Push [SET] one or more times until “PoF” appears.
 - Pushing [MONI] reverses the order of selection.
- ④ Rotate the tuning dial to select the desired auto power-off time or turn the timer OFF (“oF”).
 - “AO” appears when an auto power-off time is set.
- ⑤ Push [PWR] momentarily to exit initial set mode.

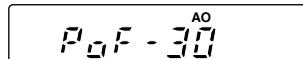

The display shows that the 30 min. timer is selected.

■ Cooling fan setting

USING INITIAL SET MODE

The transceiver has a heatsink and cooling fan to radiate heat. The cooling fan automatically turns ON while transmitting and remains ON for 2 min. after transmitting. The cooling fan can be activated continuously, if desired.

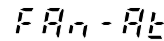

The display shows that the cooling fan is set for automatic operation.

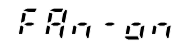

The display shows that the cooling fan is set for continuous operation.

- ① Push [PWR] to turn power OFF.
- ② While pushing [SET], turn power ON to enter initial set mode.
- ③ Push [SET] one or more times until “FAN” appears.
 - Pushing [MONI] reverses the order of selection.
- ④ Rotate the tuning dial to set the cooling fan to automatic (“At”) or continuous (“on”).
- ⑤ Push [PWR] momentarily to exit initial set mode.

14 OTHER FUNCTIONS

■ Microphone [F-1]/[F-2] keys

Switches on the transceiver's front panel can be assigned to the microphone's [F-1] and [F-2] keys.

- ① Turn power OFF.
- ② While pushing the desired switch on the transceiver and [F-1] or [F-2] on the microphone, turn power ON.
 - The switches' function is programmed into the key ([F-1] or [F-2]).

• Default setting

The following functions are assigned to the [F-1]/[F-2] keys when first applying power or after CPU resetting:

[F-1]: selects output power; push and hold to select duplex setting

[F-2]: selects a tone function or none at all; push and hold to start/stop tone scan

■ Display dimmer

USING SET MODE

Adjust to suit lighting conditions and personal preference.

- ① Push and hold [SET] one or more times until "d-1"–"d4" appears as follows.
 - Pushing [MONI] reverses the order of selection.
- ② Rotate the tuning dial to set the desired intensity.
 - Intensity can be set from "d1" (dark) to "d4" (bright).
- ③ Push [V/MHz] to return to normal operation.

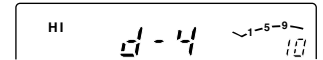

The display shows the display backlighting set to brightest.

■ Demonstration display

A demonstration function is available at power ON. This function gives you a quick visual introduction to the function display indicators.

- ① While pushing [BAND], push [PWR] to turn power ON.
 - The transceiver cycles through a visual tour of the function display indicators.
- ② Push any switch to exit demonstration mode and enter the normal operating condition temporarily.

NOTE: The transceiver automatically returns to demonstration mode after 2 min. in which no operations are performed. To deactivate the demonstration display permanently, turn power OFF, then while pushing [BAND], turn power ON again.

■ Squelch delay

USING INITIAL SET MODE

During operation, received signal strength often fluctuates. This can result in annoying repeated opening and closing of the squelch during reception of the same signal. The IC-207H has a built-in squelch delay function which helps prevent this. When both stations are operating from a fixed location, this function should be set to “short” e.g. packet operation.

- ① Push [PWR] to turn power OFF.
- ② While pushing [SET], turn power ON to enter initial set mode.
- ③ Push [SET] one or more times until “Sqt” appears.
 - Pushing [MONI] reverses the order of selection.
- ④ Rotate the tuning dial to set the squelch delay to “L” (long) or “S” (short).
- ⑤ Push [PWR] momentarily to exit initial set mode.

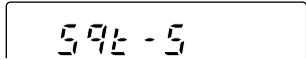

Sqt - S

The display shows the squelch delay function is set to short.

■ Packet operation

◇ Data speed

USING INITIAL SET MODE

For packet operation the transceiver can be set to one of two data speeds: 1200 bps (default) or 9600 bps.

- ① Push [PWR] to turn power OFF.
- ② While pushing [SET], turn power ON to enter initial set mode.
- ③ Push [SET] one or more times until “bPS” appears.
 - Pushing [MONI] reverses the order of selection.
- ④ Rotate the tuning dial to select the desired data speed.

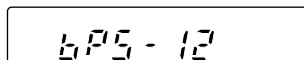

The display shows the data speed set to 1200 bps.

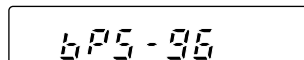

The display shows the data speed set to 9600 bps.

- ⑤ Push [PWR] momentarily to exit initial set mode.

NOTE:

For 1200 bps operation—

- Disconnect the microphone plug from the microphone connector during data transmission, otherwise the data signal and voice signal are simultaneously transmitted.

For 9600 bps operation—

- When the transceiver is set for 9600 bps data transmission in INITIAL SET MODE, the microphone signal is automatically cut. Therefore, it is not necessary to disconnect the microphone plug from the connector in this case.
- When pushing [PTT] during data transmission, data transmission is interrupted and voice signals have priority.

◇ 1200 bps packet operation

① Connect the IC-207H and a TNC as illustrated below.

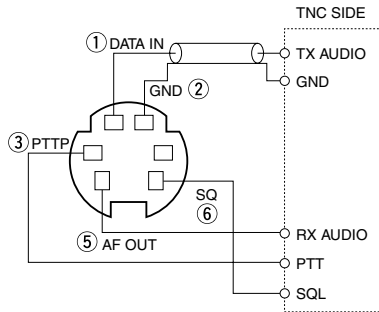

② Set the TNC for transmit.

③ Set transmit delay on the TNC to 30–50.

④ Adjust the TNC frequency deviation if necessary.

• *When using a deviation meter:*

Adjust the output of the TNC so that frequency deviation is in the range ± 3 to 4 kHz.

• *When NOT using a deviation meter:*

A receiver or transceiver is needed to monitor the transmission—compare the received audio output level when receiving a TNC modulated signal with high level voice signals using the microphone. Then adjust the TNC modulated signal to a lower level than the voice modulated signal.

NOTE:

- Read the instructions supplied with your TNC carefully before attempting packet operation with the IC-207H.
- Pin ⑤ AF OUT is for 1200 bps operation only. This pin cannot be used for 9600 bps operation.
- Over modulation may degrade signal quality. If you find that many transmissions are failing, re-adjust the modulation level.

14 OTHER FUNCTIONS

◇ 9600 bps high speed packet operation

The IC-207H supports 2 modes of 9600 bps packet operation: G3RUH and GMSK.

- ① Connect the IC-207H and a TNC as illustrated below.

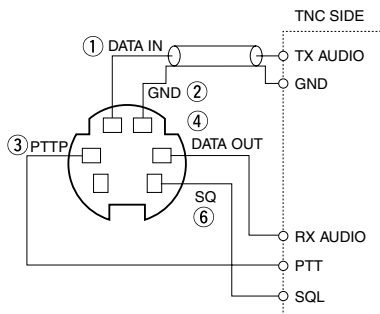

- ② G3RUH mode can handle 16 kinds of modulated wave forms in order to maintain a communication link.
- ③ Set the TNC's TX DELAY to 30–50.
- ④ Adjust the TNC frequency deviation if necessary (see page at right).

NOTE:

- When using the PTT terminal for packet operation, no voice signals are transmitted from the microphone.
- When pushing [PTT] during data transmission, data transmission is interrupted and the voice signal takes priority.
- Read the instructions supplied with your TNC carefully before attempting packet operation with the IC-207H.
- Pin ④ DATA OUT is for 9600 bps operation only. This pin cannot be used for 1200 bps operation.

◇ Adjusting the transmit signal output from the TNC

When setting data transmission speed to 9600 bps, the DATA signal coming from the TNC is applied exclusively to the internal limiter circuitry to automatically maintain band width.

NEVER apply data levels from the TNC of over 0.6 Vp-p, otherwise the transceiver will not be able to maintain the band width and may possibly interfere with other stations.

1. When using a level meter or synchroscope, adjust the TX audio output level (DATA IN level) from the TNC as follows.

0.4 Vp-p (0.2 Vrms): recommended level

0.2 Vp-p–0.5 Vp-p (0.1 Vrms–0.25 Vrms): acceptable level

2. When NOT using a measuring device.

① Connect the IC-207H to a TNC.

② Enter a test mode (“CAL”, etc.) on the TNC, then transmit some test data.

③ *When the transceiver fails to transmit the test data or transmits sporadically (TX indicator doesn’t appear or flashes):*

Decrease the TNC output level until the transmit indicator lights continuously.

When transmission is not successful even though the TX indicator lights continuously:

Increase the TNC output level.

15 MAINTENANCE

■ Troubleshooting

If your transceiver seems to be malfunctioning, please check the following points before sending it to a service center.

PROBLEM	POSSIBLE CAUSE	SOLUTION	REF.
No power comes on.	<ul style="list-style-type: none"> • Power connector has a poor contact. • Polarity of the power connection is reversed. • Blown fuse. 	<ul style="list-style-type: none"> • Check the connector pins. • Reconnect the power cable observing the proper polarity. Replace the fuse, if damaged. • Check the cause, then replace the fuse. 	— pgs. 13, 69 p. 69
No sound comes from the speaker.	<ul style="list-style-type: none"> • Volume level is too low. • The squelch level is set too tight. • A selective call or squelch function is activated such as pocket beep or tone squelch. 	<ul style="list-style-type: none"> • Rotate [VOL] clockwise. • Set the squelch level to the threshold. • Turn the appropriate function OFF. 	p. 20 p. 20 pgs. 50, 51
Sensitivity is low and only strong signals are audible.	<ul style="list-style-type: none"> • Antenna feedline or the antenna connector solder has a poor contact or is short circuited. 	<ul style="list-style-type: none"> • Check, and if necessary, replace the feedline or solder the antenna connector again. 	p. 14
No contact possible with another station.	<ul style="list-style-type: none"> • The transceiver is set to semi-duplex. • The other station is using tone squelch. 	<ul style="list-style-type: none"> • Set to simplex. • Turn ON the tone squelch function. 	p. 24 p. 51
Repeater cannot be accessed.	<ul style="list-style-type: none"> • Wrong offset frequency is programmed. • Wrong subaudible tone frequency is programmed. 	<ul style="list-style-type: none"> • Correct the offset frequency. • Correct the subaudible tone frequency. 	p. 27 p. 26
Frequency cannot be set.	<ul style="list-style-type: none"> • The frequency lock function is activated. • Priority watch is paused on the watching frequency. 	<ul style="list-style-type: none"> • Turn the function OFF. • Push [(M/CALL)PRIO] to resume the watch. 	p. 16 p. 45
Frequency cannot be set via the microphone.	<ul style="list-style-type: none"> • The frequency lock function is activated. • The microphone keypad lock function is activated. • Priority watch is paused on the watching frequency. 	<ul style="list-style-type: none"> • Push and hold LOCK to deactivate the frequency lock function. • Push [FUNC], then [Ⓜ16KEY LOCK] to deactivate the microphone keypad lock function. • Push [(M/CALL)PRIO] to resume the watch. 	p. 16 p. 16 p. 45

PROBLEM	POSSIBLE CAUSE	SOLUTION	REF.
Some memory channels cannot be selected via the microphone keypad.	<ul style="list-style-type: none"> • The input channel number has not yet been programmed. 	<ul style="list-style-type: none"> • Rotate the tuning dial to check whether the channel has been programmed or not. 	p.29
Scan does not operate.	<ul style="list-style-type: none"> • Squelch is open. • The selected scan edge memory channels (e.g. 1 A and 1b) have the same frequencies (for programmed scan). • Only 1 memory channel is programmed or other channels are set as skip channels. • Priority watch is activated. 	<ul style="list-style-type: none"> • Set the squelch to the threshold point. • Reset the scan edges. • Program other memory channels or cancel the memory skip function in the desired channels. • Turn the function OFF. 	<p>p. 20 p. 40</p> <p>pgs. 30, 42 p. 45</p>
Transmission is automatically cut off.	<ul style="list-style-type: none"> • Time-out timer is activated. 	<ul style="list-style-type: none"> • Set the timer to OFF. 	p. 59
Transmission continues even when the PTT is released.	<ul style="list-style-type: none"> • One-touch PTT function is activated. 	<ul style="list-style-type: none"> • Turn the function OFF. 	p. 23
The function display shows erroneous information.	<ul style="list-style-type: none"> • The CPU is malfunctioning. 	<ul style="list-style-type: none"> • Reset the CPU. 	p. 69

■ Fuse replacement

If the fuse blows or the transceiver stops functioning, find the source of the problem if possible, and replace the damaged fuse with a new, rated one (FGB 20 A) as shown in the diagram below.

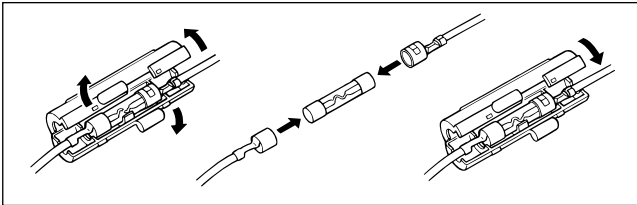

■ Partial resetting

If you want to initialize the operating conditions without clearing the memory contents, etc., a partial reset function is available for the transceiver.

While pushing [V/MHz], turn power ON to partially reset the transceiver.

- ◆ *Initialized settings:* VFO frequency, SET mode settings.
- ◆ *Retained settings:* Memory channels, call channels, offset freq. in memory/call, DTMF memory, initial SET mode settings.

■ Resetting the CPU

The function display may occasionally display erroneous information, (e.g. when first applying power). This may be caused externally by static electricity, or by other factors.

If this problem occurs, turn power OFF. After waiting a few seconds, turn power ON again. If the problem persists, perform the following procedure.

Partial resetting is alternatively available. See previous section for details.

CAUTION: Resetting the transceiver **CLEARs** all memory information, and initializes all values in the trans-

- ① Push [PWR] to turn power OFF.
- ② While pushing [SET] and [S.MW], turn power ON.
 - “CLEAR” appears and the transceiver is reset.

SPECIFICATIONS 16

General

- Frequency coverage

VERSION		VHF	UHF
U.S.A.	Tx	144–148 MHz	440–450 MHz
	Rx	118–174 MHz* ¹	
Asia	Tx	144–148 MHz	430–440 MHz
	Rx	136–174 MHz* ¹	
Europe		144–146 MHz	430–440 MHz
Italy	Tx	144–148 MHz	430–440 MHz
	Rx	136–174 MHz* ¹	400–479 MHz* ²

*¹Guaranteed frequency coverage is 144–148 MHz.

*²Guaranteed frequency coverage is 430–440 MHz.

- Mode : FM, AM*
(*U.S.A. ver. only; 118–135.995 MHz)
- Antenna impedance : 50 Ω (SO-239)
- Scanning speed : 16 ch/sec. (programmed scan)
8 ch/sec. (memory scan)
- Power supply requirement : 13.8 V DC ± 15%
- Usable temperature range : -10°C to +60°C; +14°F to +140°F
- Dimensions : 140(W) × 40(H) × 184.5(D) mm
(projections not included) 5½(W) × 1⅞(H) × 7¼(D) in
- Weight : 1.17 kg; 2.6 lb

Transmitter

- Modulation system : Variable reactance frequency modulation
- Max. frequency deviation : ± 5.0 kHz
- Spurious emissions : Less than -60 dB

- Microphone impedance : 600 Ω (8-pin modular)
- Output power and current drain:

CONDITION		POWER	CURRENT
144 MHz	High	50 W	12.0 A
	Mid-High	20 W	6.5 A
	Mid-Low	10 W	5.5 A
	Low	5 W	4.5 A
430(440) MHz	High	35 W	11.0 A
	Mid-High	20 W	6.5 A
	Mid-Low	10 W	5.5 A
	Low	5 W	4.5 A

Receiver

- Receive system : Double conversion superheterodyne
- Intermediate frequencies : 1st 46.05 MHz 2nd 450 kHz
- Sensitivity (for 12 dB SINAD) : Less than 0.18 μV
- Squelch sensitivity : Less than 0.13 μV (at threshold)
- Selectivity : More than 12 kHz/-6 dB
Less than 30 kHz/-60 dB
- Spurious response rejection ratio : More than 60 dB
- Audio output power : More than 2.0 W at 10% distortion with the 8 Ω internal speaker
- Current drain :
 - Max rated audio : 1.0 A
 - Standby : 0.8 A

All stated specifications are subject to change without notice or obligation.

17 OPTIONS

Some of the following options may not be available due to variations in local electrical standards, etc. If you have any questions regarding options please consult your Icom Dealer.

◇ Speakers

SP-7 EXTERNAL SPEAKER

For base station use. Cable length: 1.0 m; 3.3 ft

SP-10 EXTERNAL SPEAKER

Compact design. Cable length: 1.5 m; 4.9 ft

SP-12 EXTERNAL SPEAKER

Slim-type. Cable length: 2.0 m; 6.6 ft

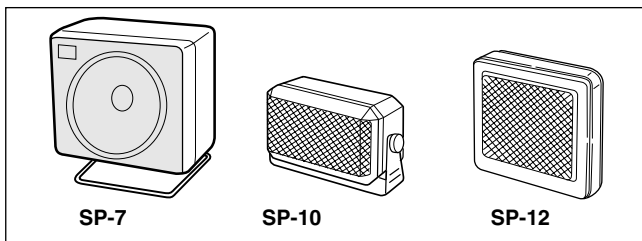

◇ Separation accessories

OPC-600/601 SEPARATION CABLE

For operation with the front panel detached.

Cable length

OPC-600: 3.5 m; 11.5 ft OPC-601: 7.0 m; 23.0 ft

MB-58 REMOTE CONTROLLER BRACKET

Mounts the remote controller in a convenient location for operation with the front panel detached from the main body.

MB-65 REMOTE CONTROLLER BRACKET

Mounts the remote controller with MB-58. Adjustable angle and direction for optimum installation positioning.

OPC-440/647 MIC EXTENSION CABLE

Cable length

OPC-440: 5.0 m; 16.4 ft OPC-647: 2.5 m; 8.2 ft.

OPC-347 DC POWER CABLE

Has a 20 A capacity and a length of 7.0 m (23.0 ft).

OPC-441 SPEAKER EXTENSION CABLE

Cable length: 5.0 m; 16.4 ft.

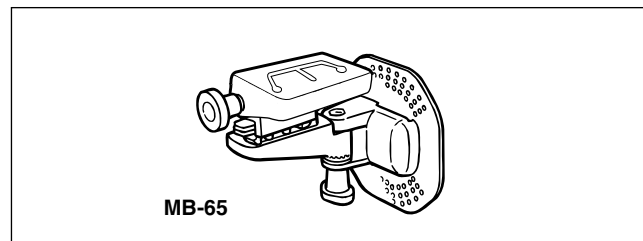

◇ **Wireless microphone accessories**

HM-90 WIRELESS MICROPHONE

Infrared, full remote control microphone. Wired remote control is also possible.

EX-1759 INFRARED RECEIVER

Used to receive control signals from the HM-90.

EX-1513 INFRARED SUB RECEIVER

Used with the EX-1759 to increase remote control reliability and extend the controllable area.

CP-13/L CIGARETTE LIGHTER CABLE WITH NOISE FILTER

OPC-288/L DC POWER CABLE

Supply power to the BC-96 for charging the Ni-Cd battery inside the HM-90 when the BC-96 cannot be connected to the EX-1759 directly.

◇ **Others**

MB-17A MOBILE MOUNTING BRACKET

One-touch bracket. Transceiver body is easily attached and removed.

IC-PS30 DC POWER SUPPLY

Provides 13.8 V DC and 25 A max. for base station use.

CS-207 CLONING SOFTWARE + **OPC-646** CLONING CABLE

Provides quick and easy programming of items, including memory channels and set mode contents, for local repeater frequencies, etc.

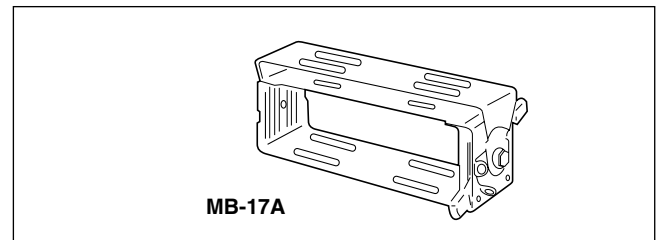
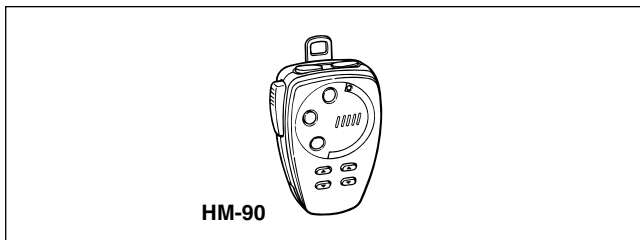

18 MODE ARRANGEMENT

Although the following chart refers mainly to the VHF band, the transceiver has the same mode arrangement in the UHF band.

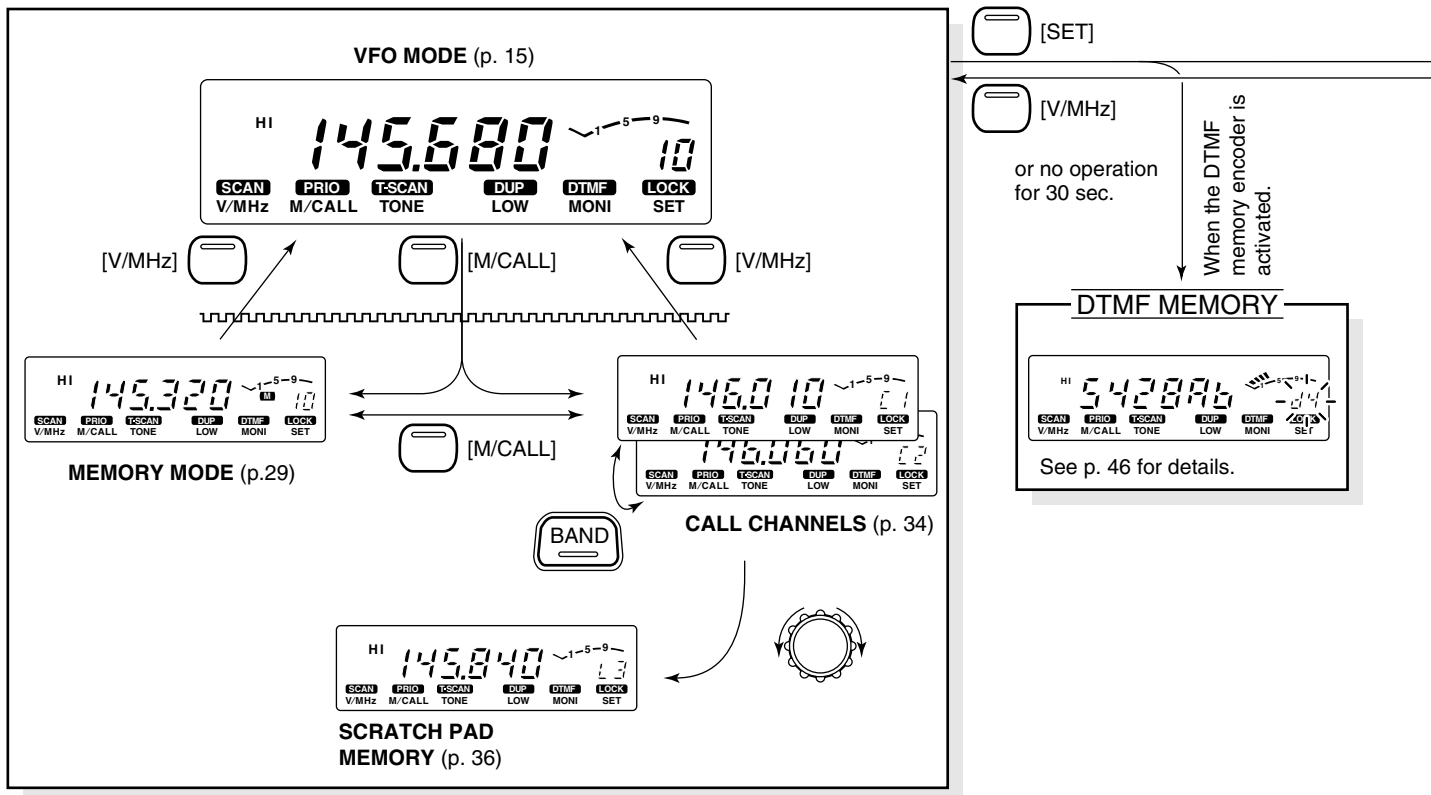

SET MODE

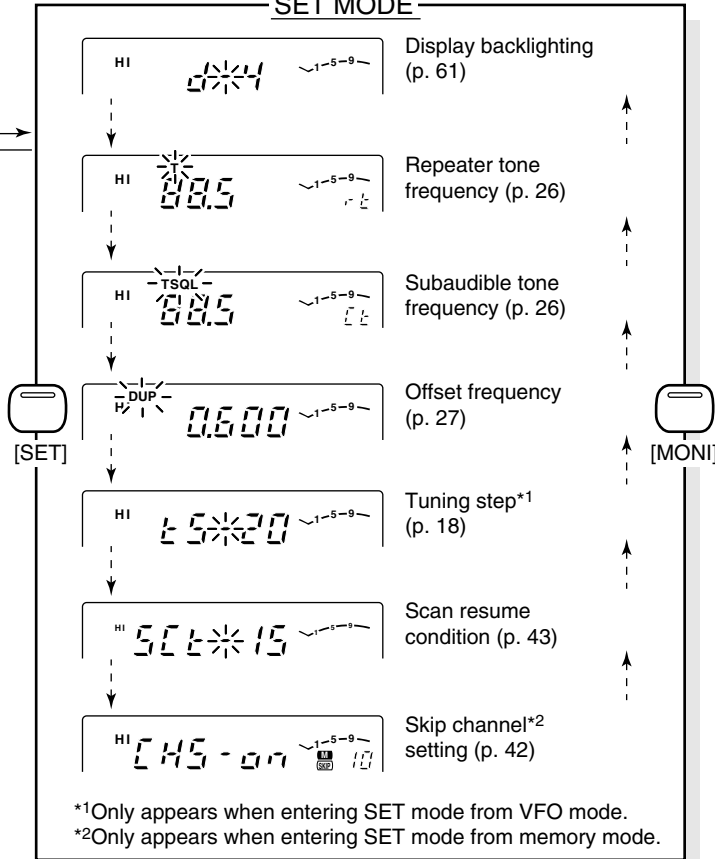

INITIAL SET MODE

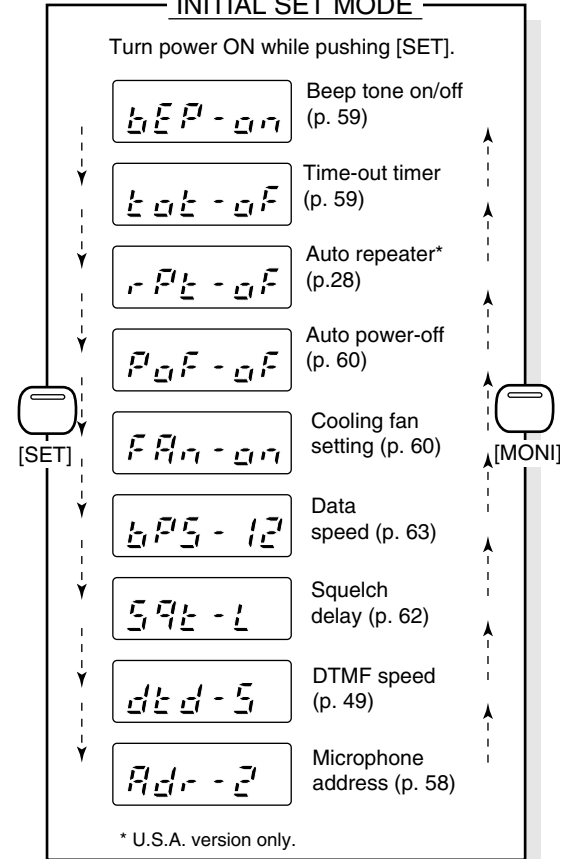

Count on us!

A-5417D-1EX-①
Printed in Japan
Copyright © 1996 by Icom Inc.

Icom Inc
6-9-16 Kamihigashi, Hirano-ku, Osaka 547 Japan