

SECTION IX BLOCK DIAGRAM

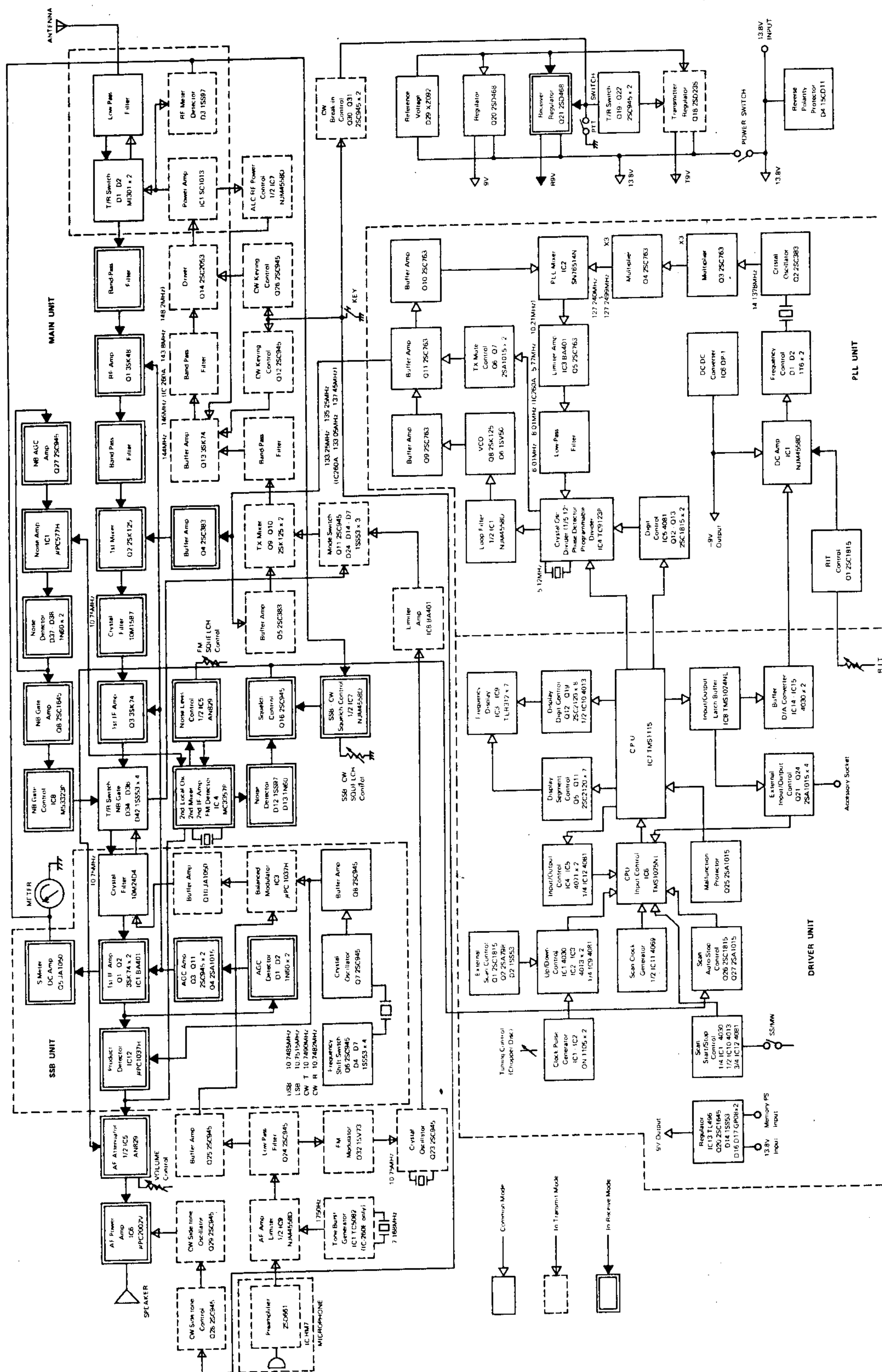

SCHEMATIC DIAGRAM

Scanned by IW1XR
 Downloaded by
 Amateur Radio Directory

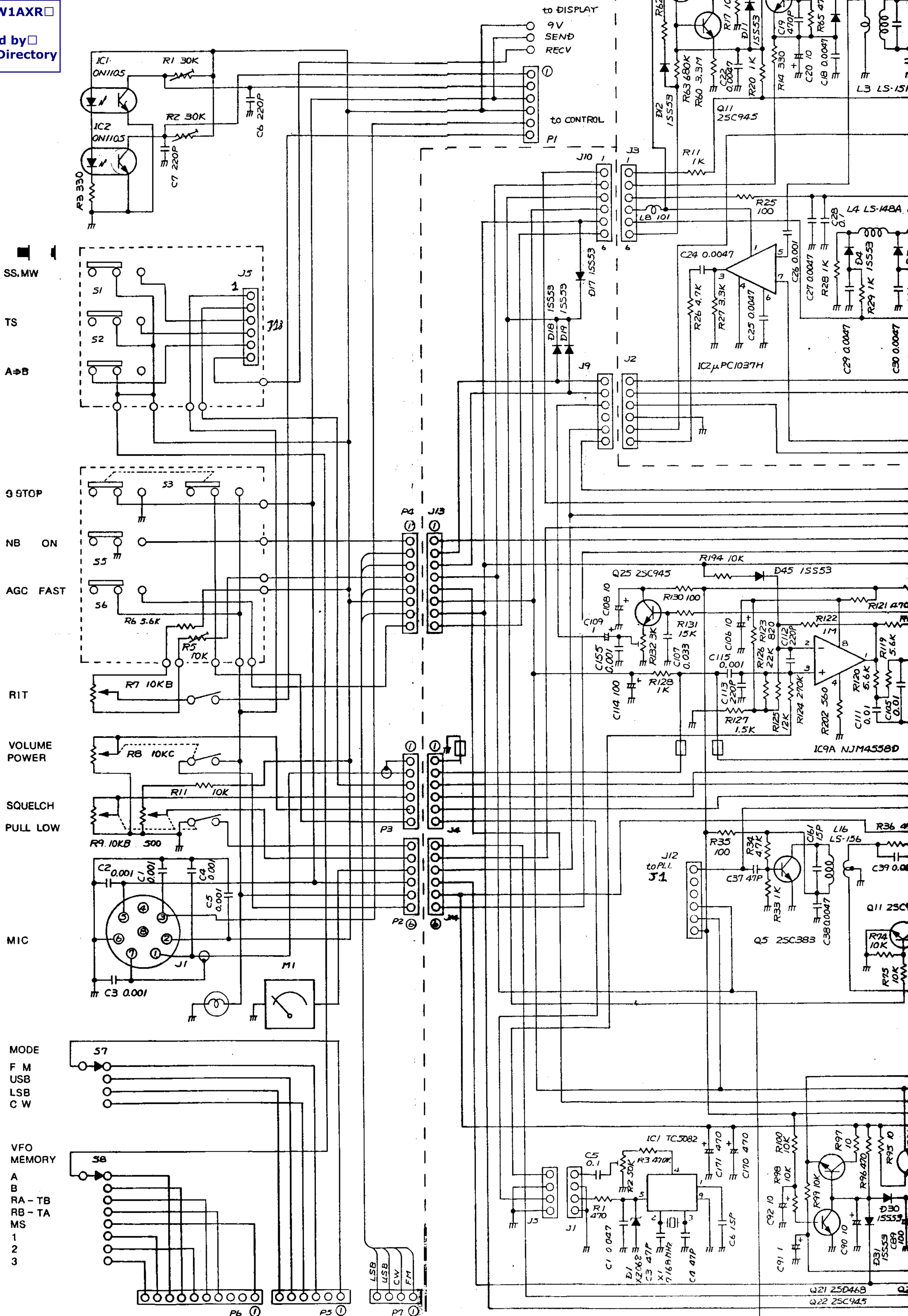

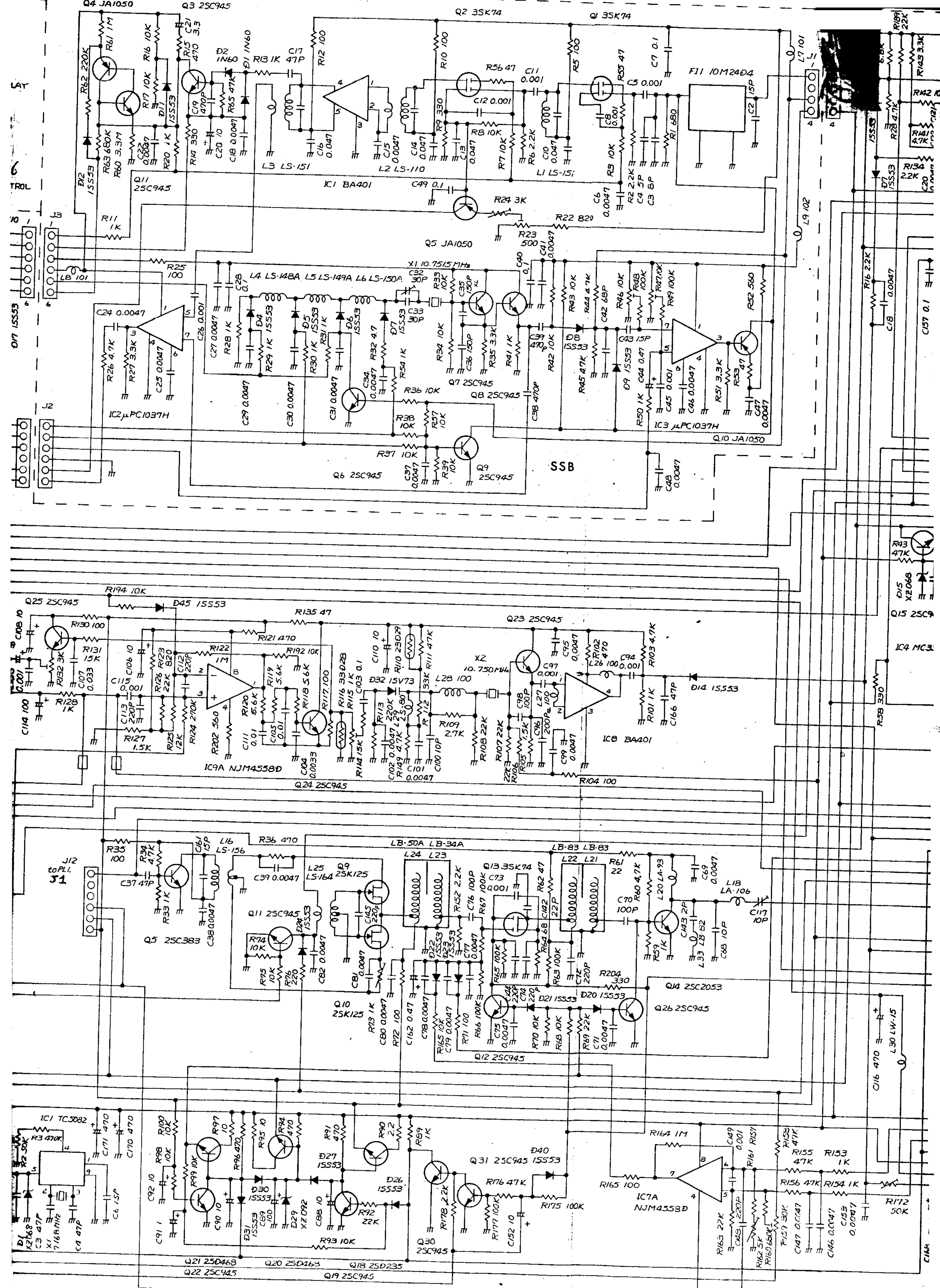

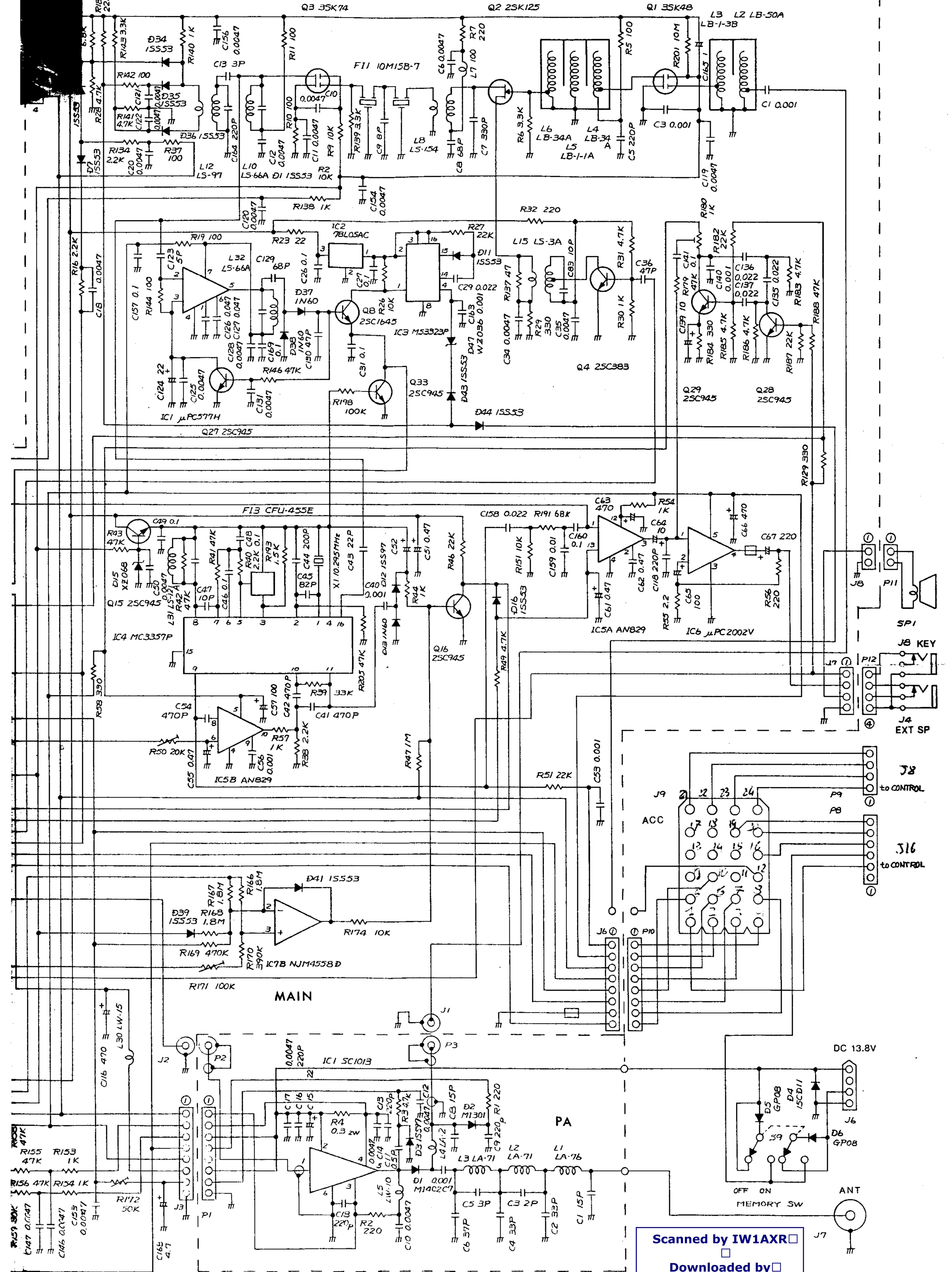

Scanned by IW1AXR
 Downloaded by
 Amateur Radio Directory

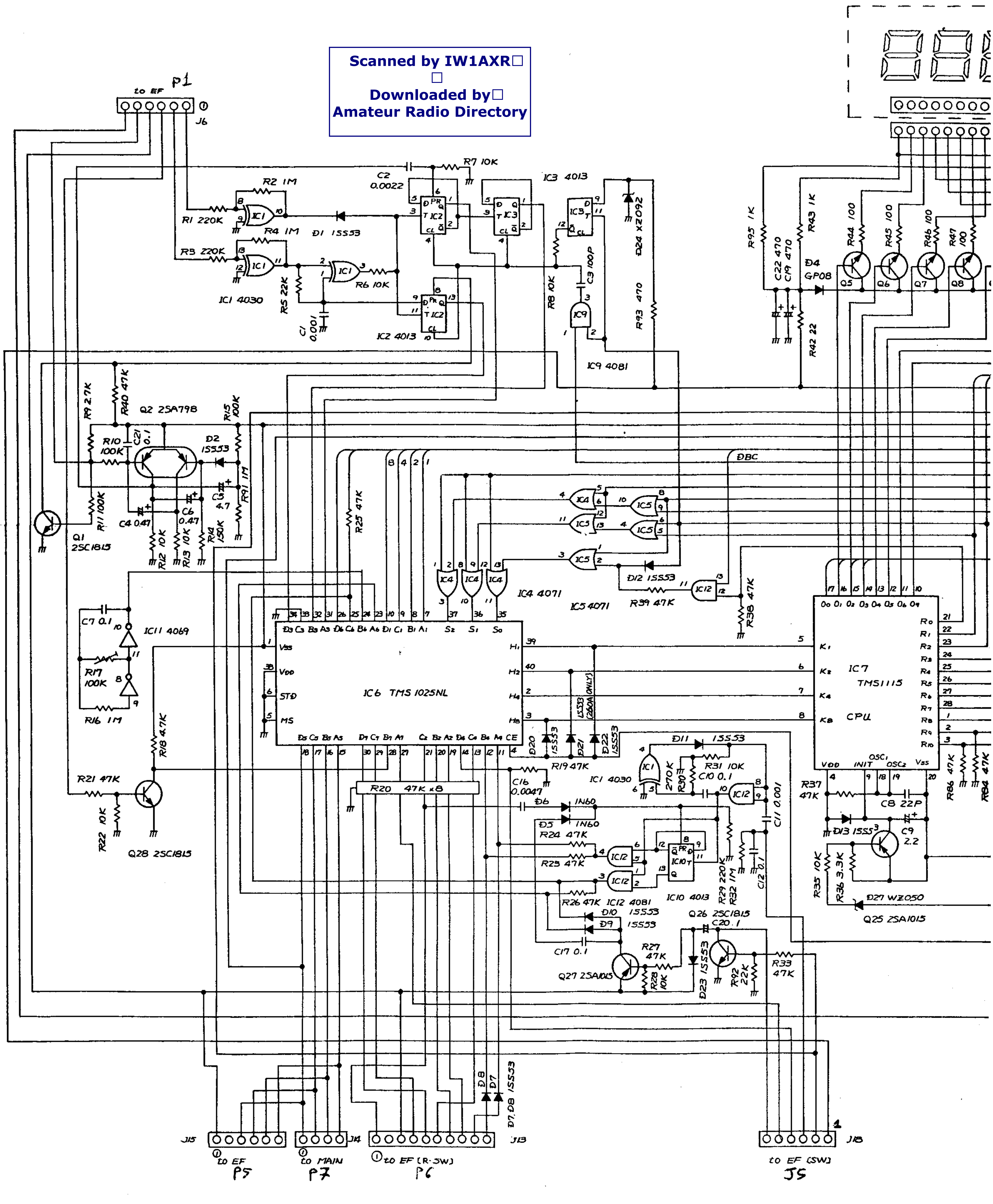

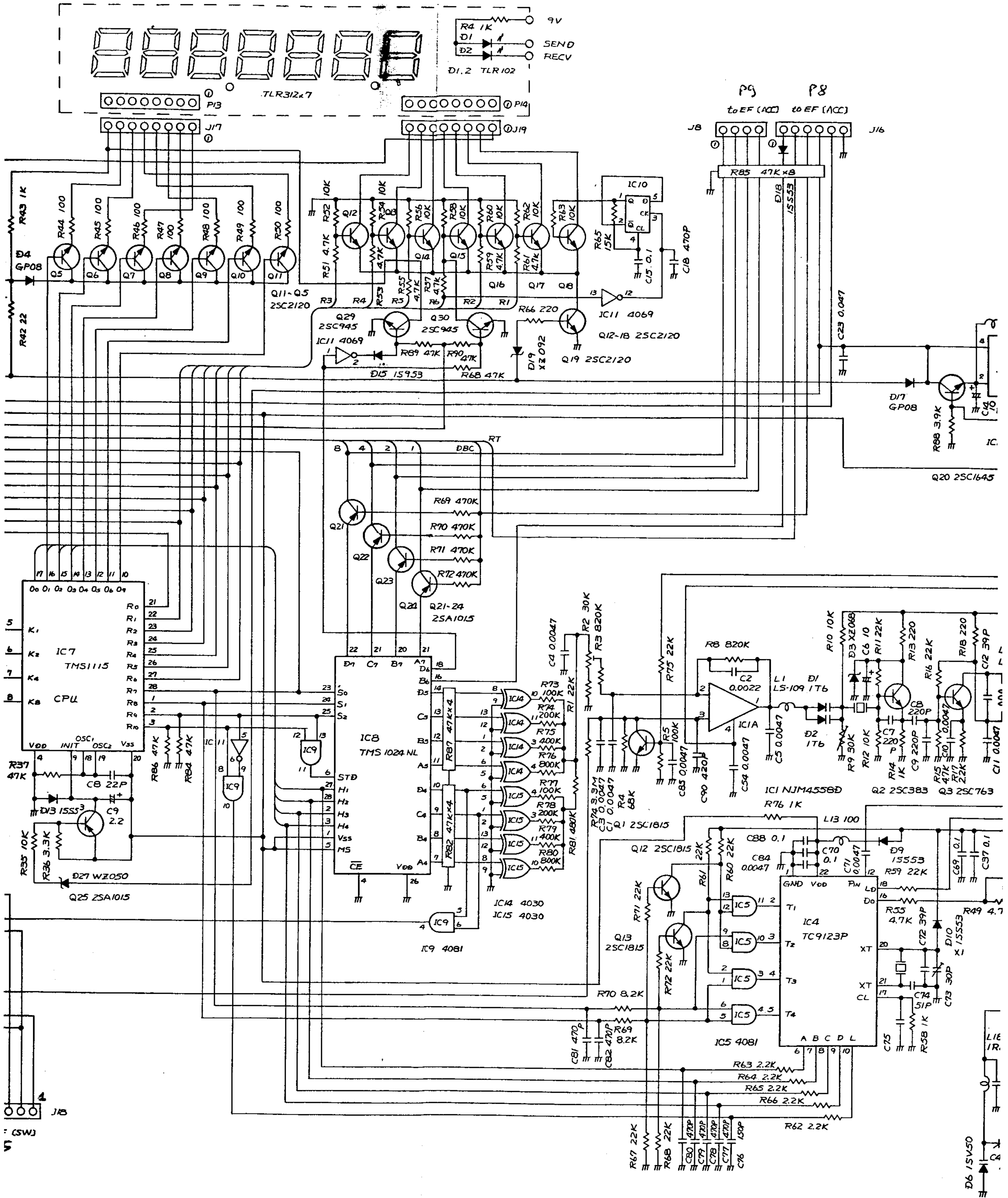

V1 (SW)

D6 15V50

P8

(ACC) 80 EF (ACC)

J16

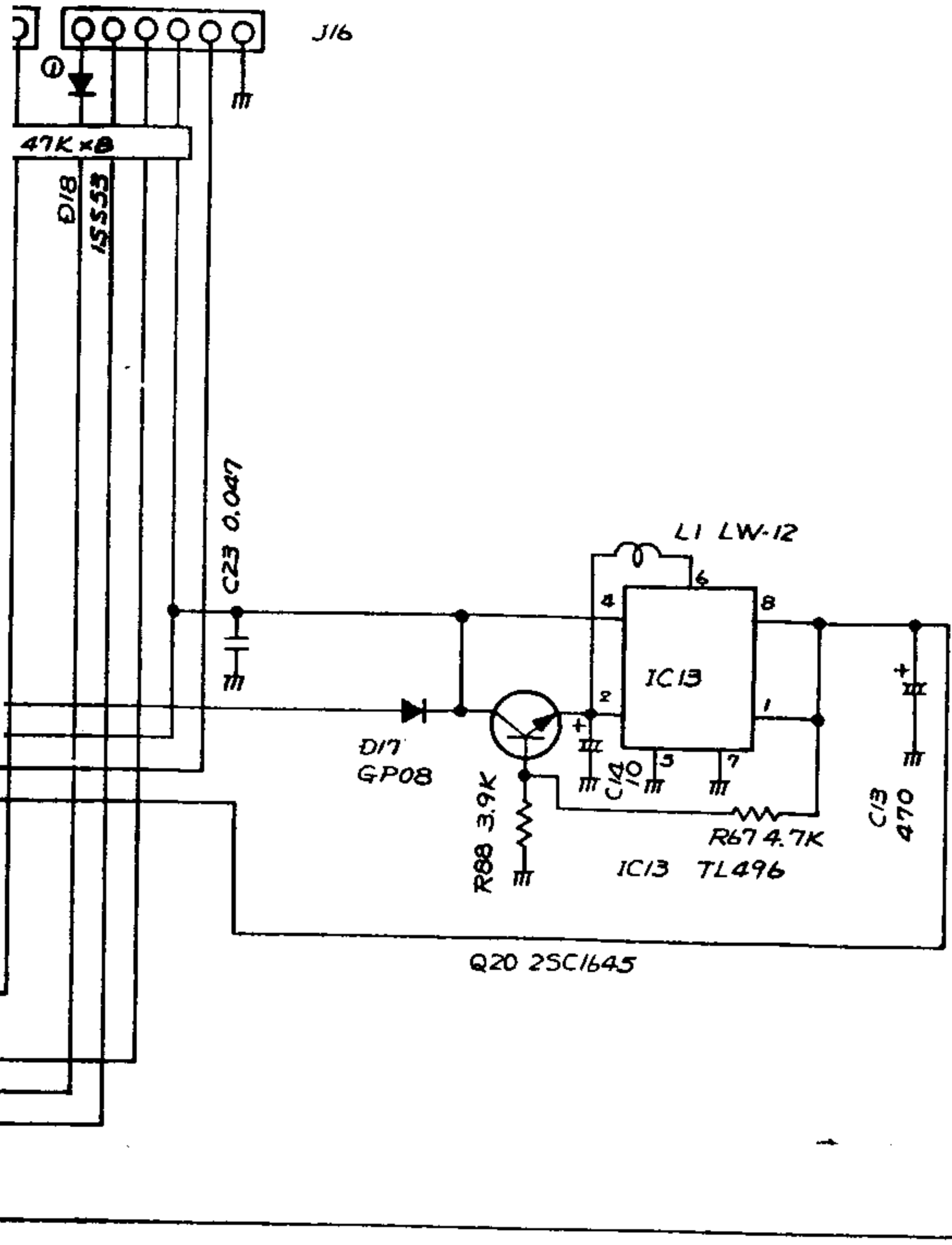

Scanned by IW1AXR
 Downloaded by
 Amateur Radio Directory

to MAIN J12

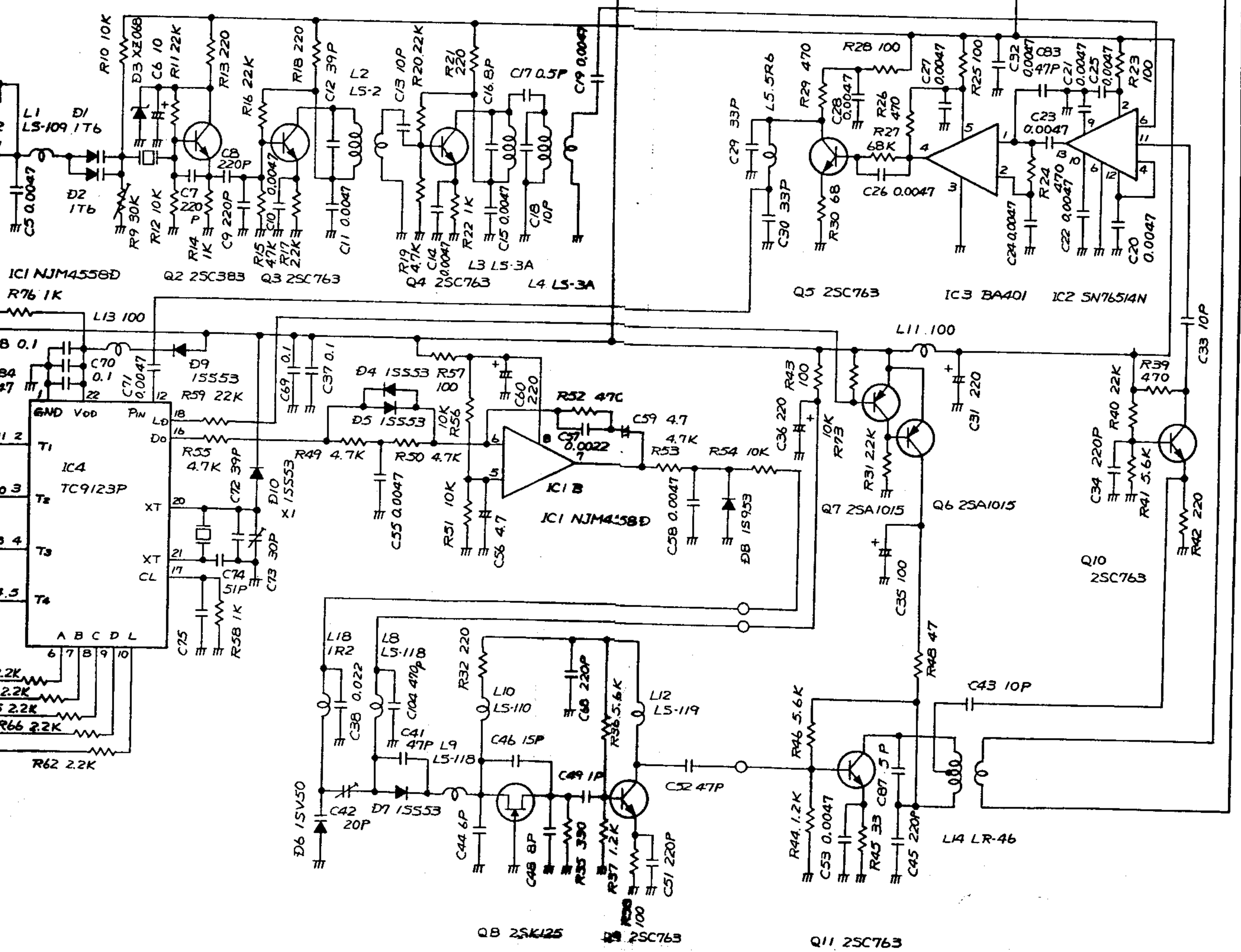
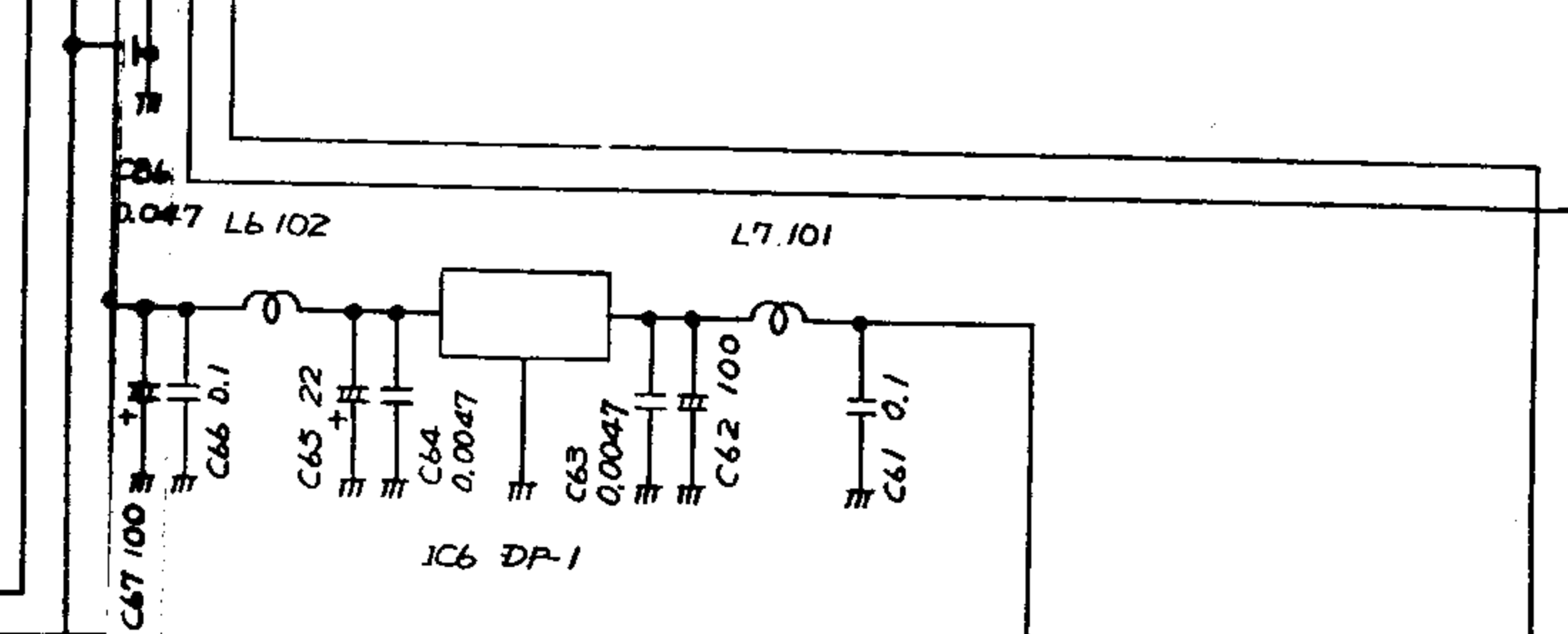

2.2K
2.2K
5.22K
R66 2.2K

6 7 B 9 10
A B C D L

2.2K
2.2K
5.22K
R66 2.2K

MAIN UNIT

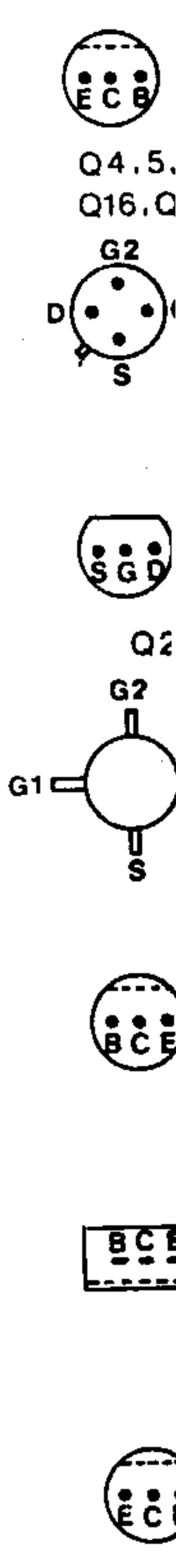
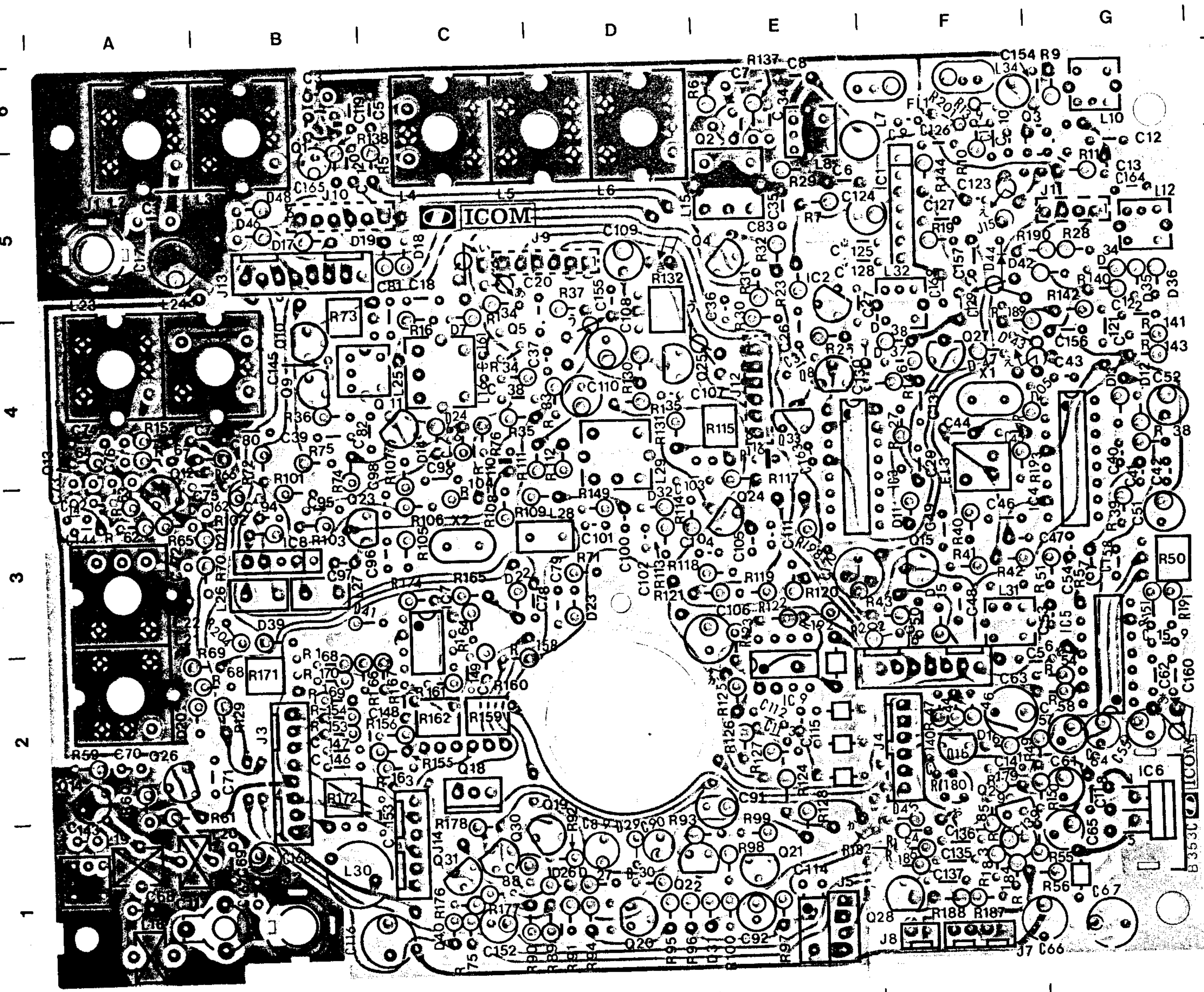

Scanned by IW1AXR
 Downloaded by
 Amateur Radio Directory

SSB UNIT

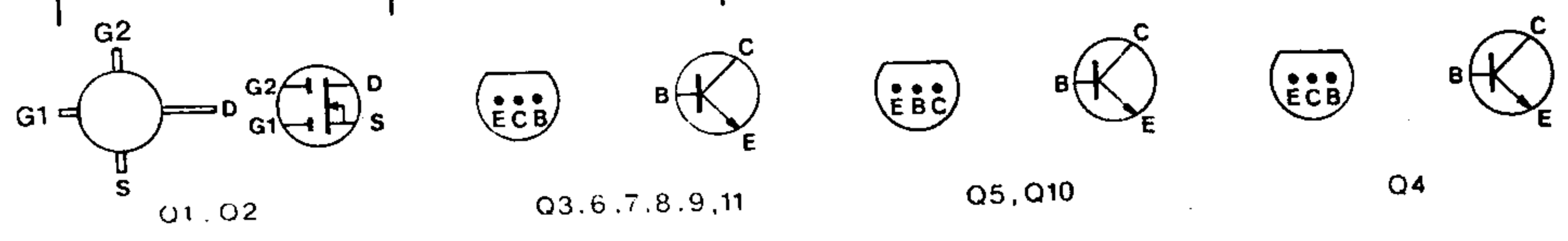
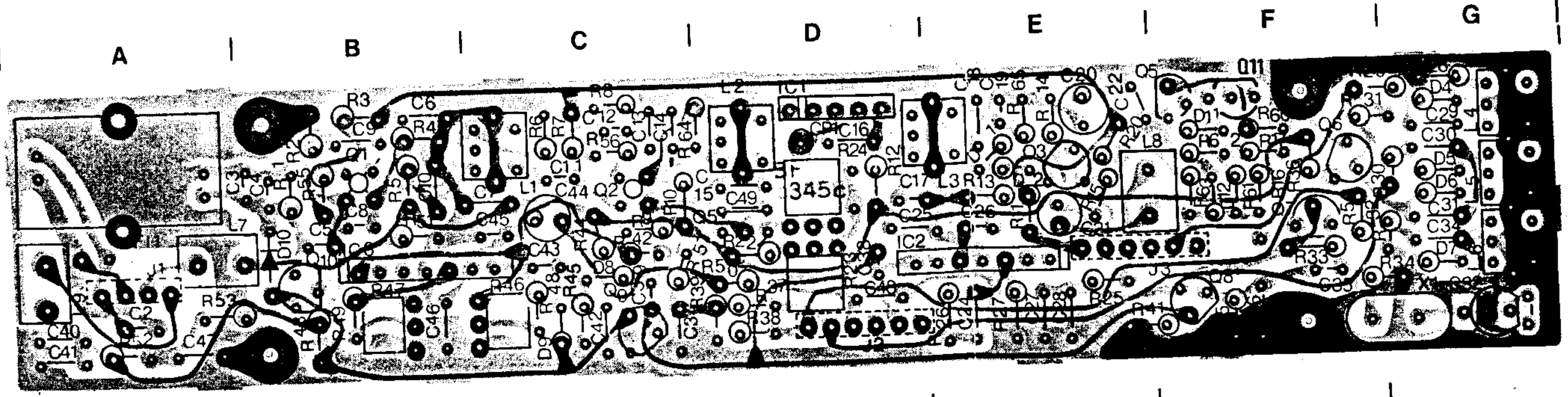

PLL / DRIVER UNIT

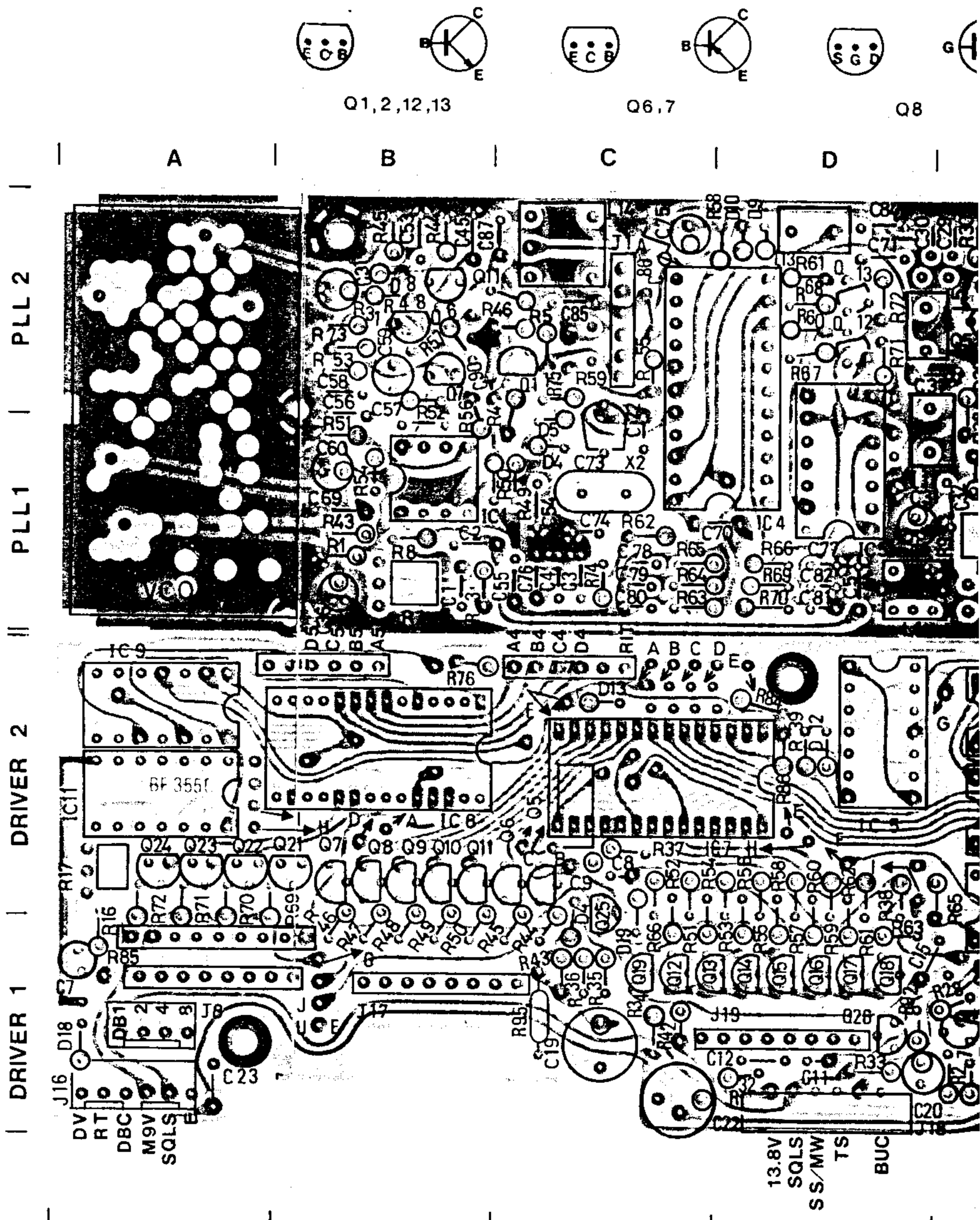
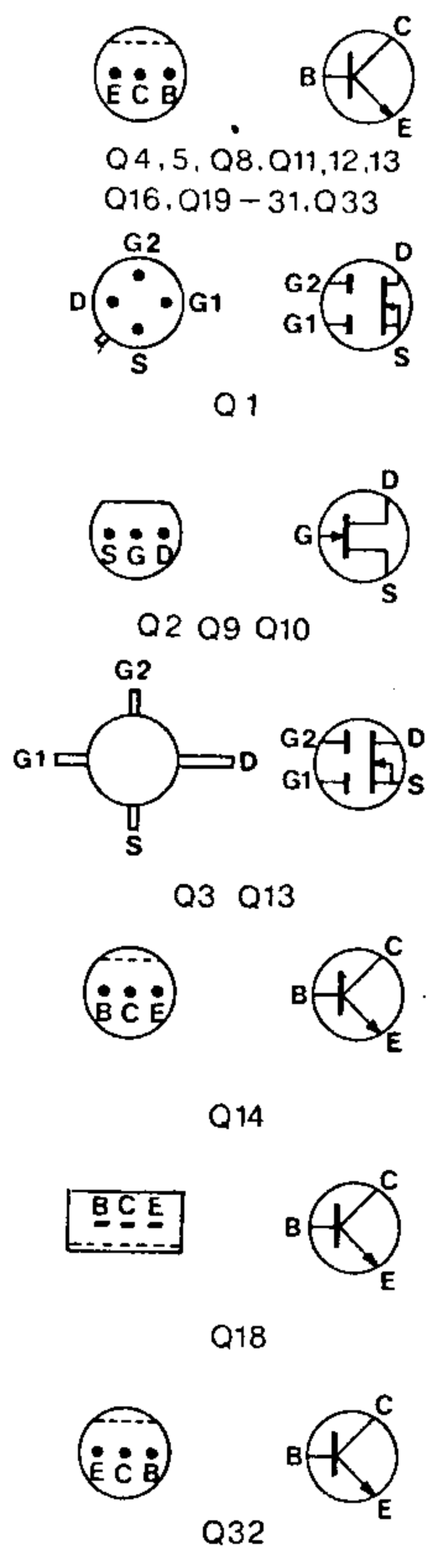
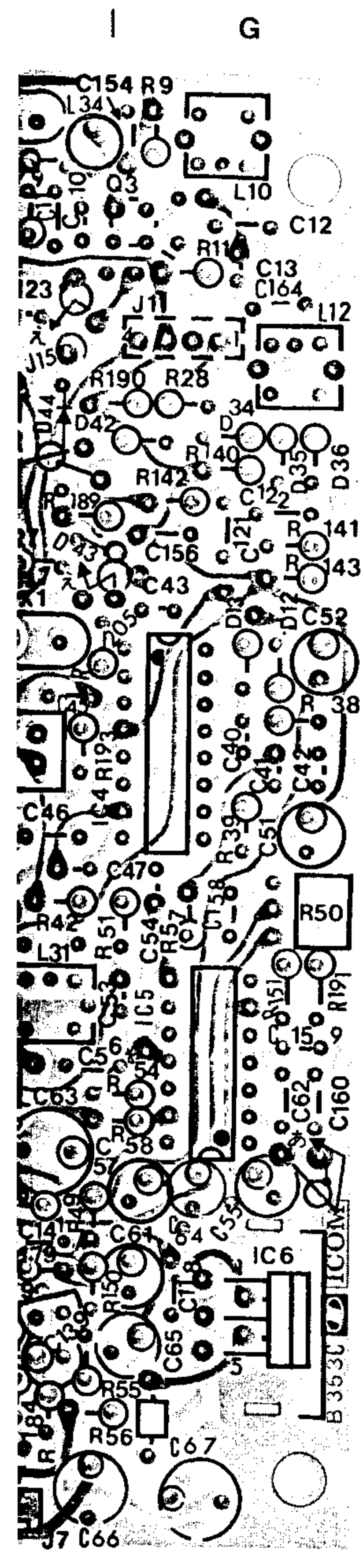

Scanned by IW1AXR
Downloaded by Amateur Radio Directory

DRIVER SUB BOARD

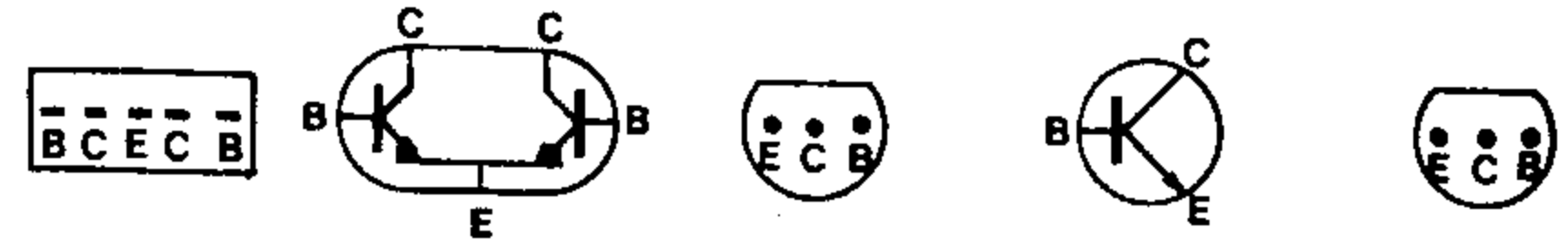
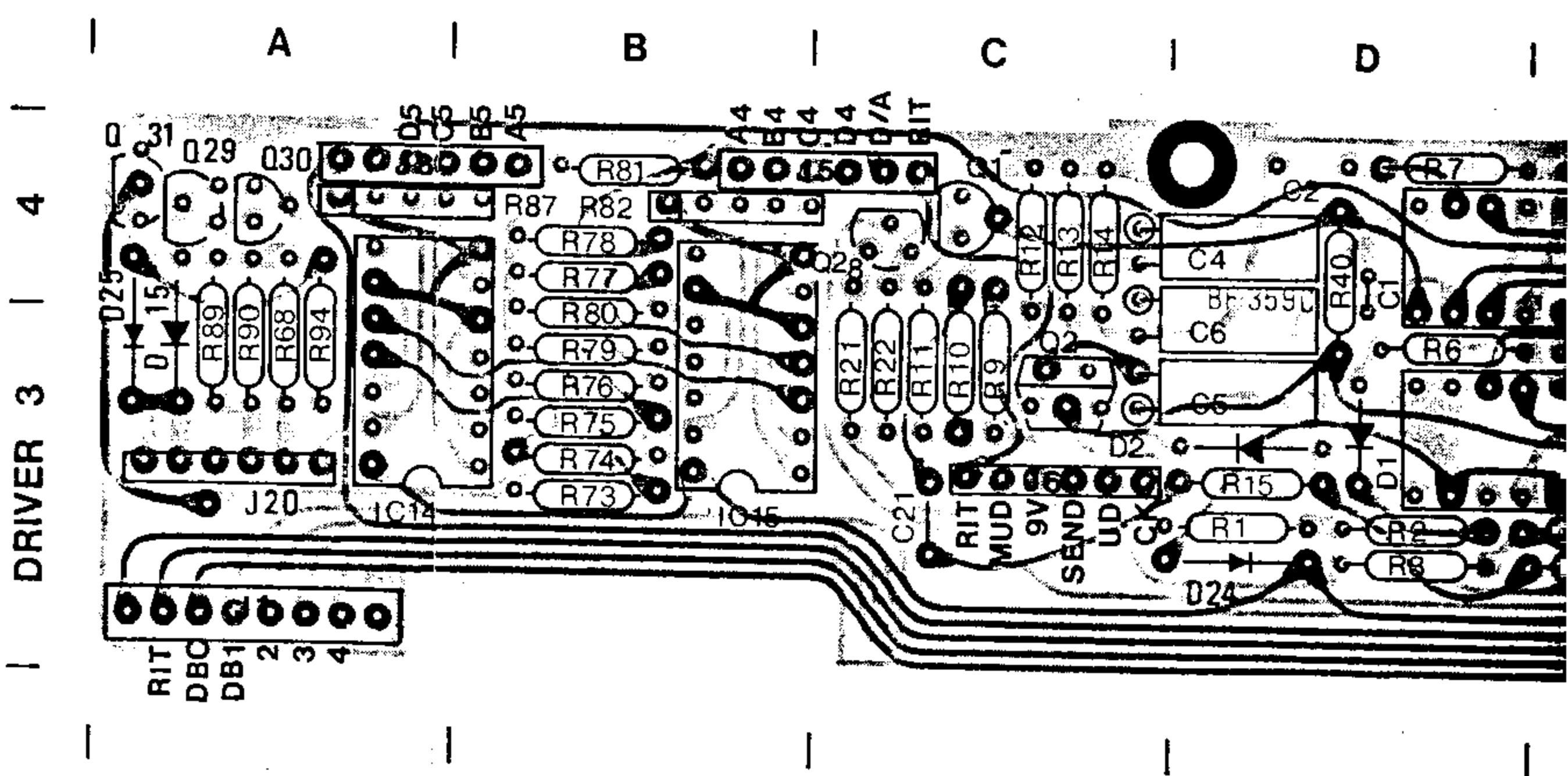
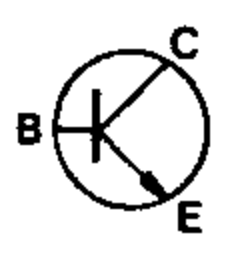
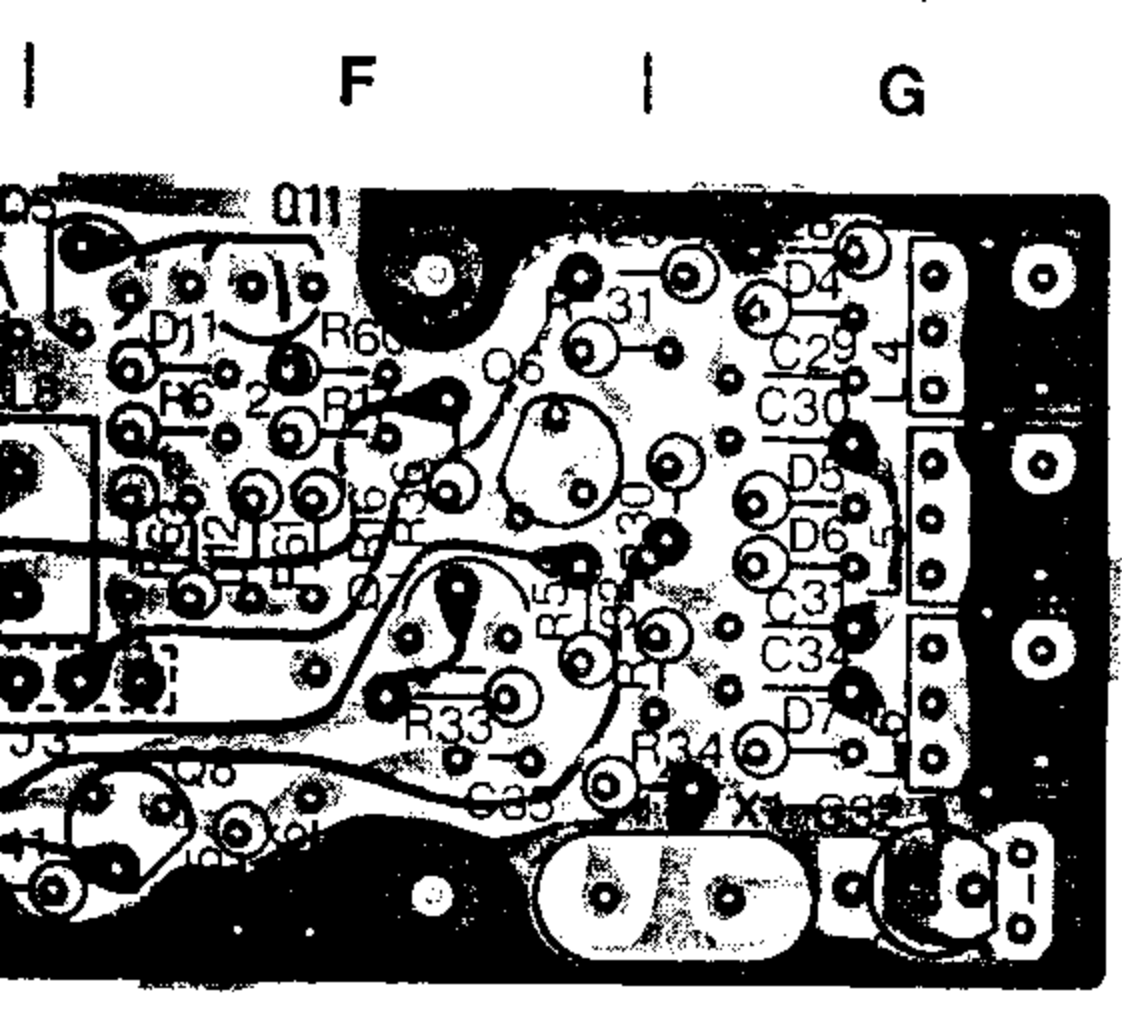



Q8 Q3,4,5,9,10,11

E F G

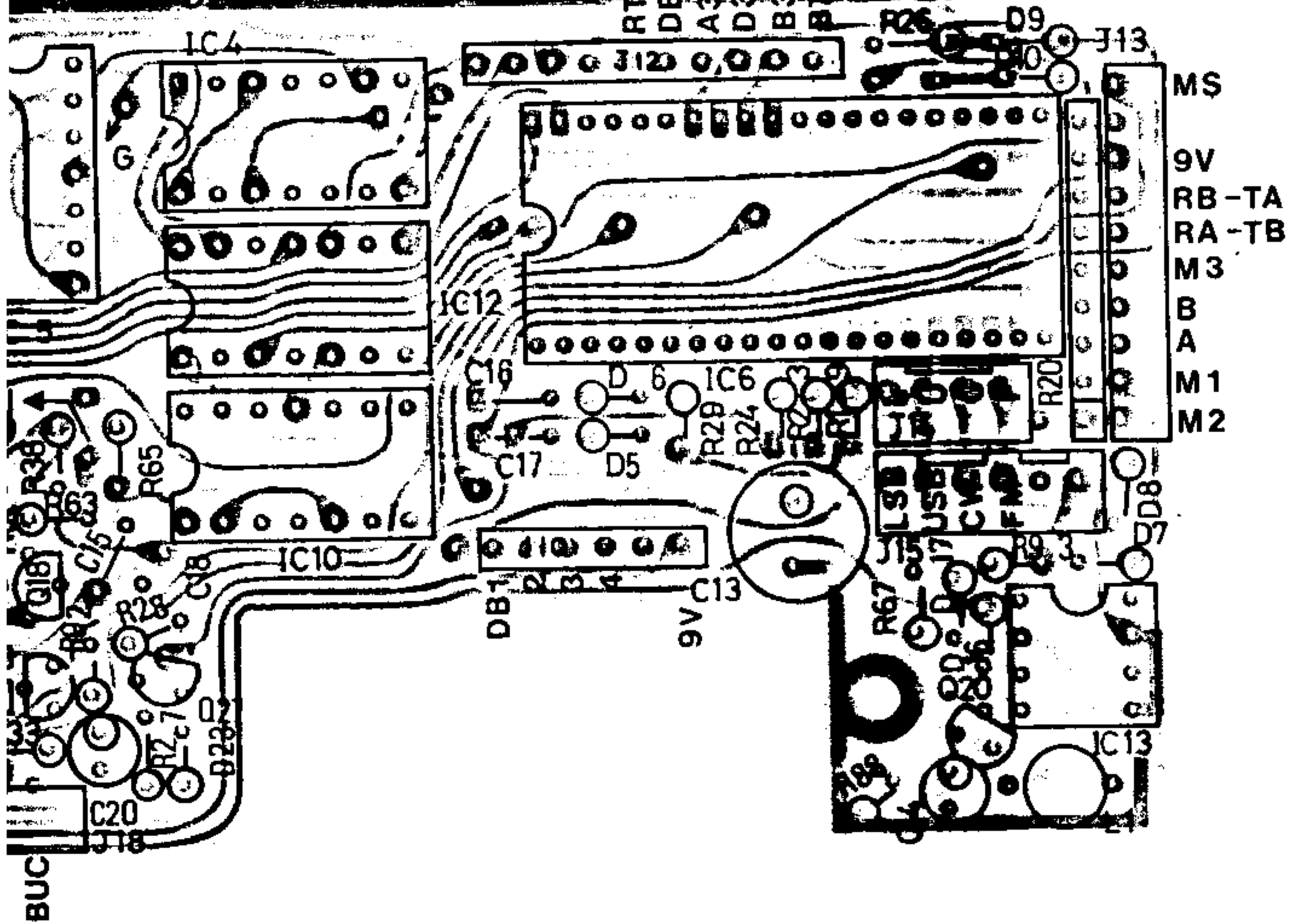
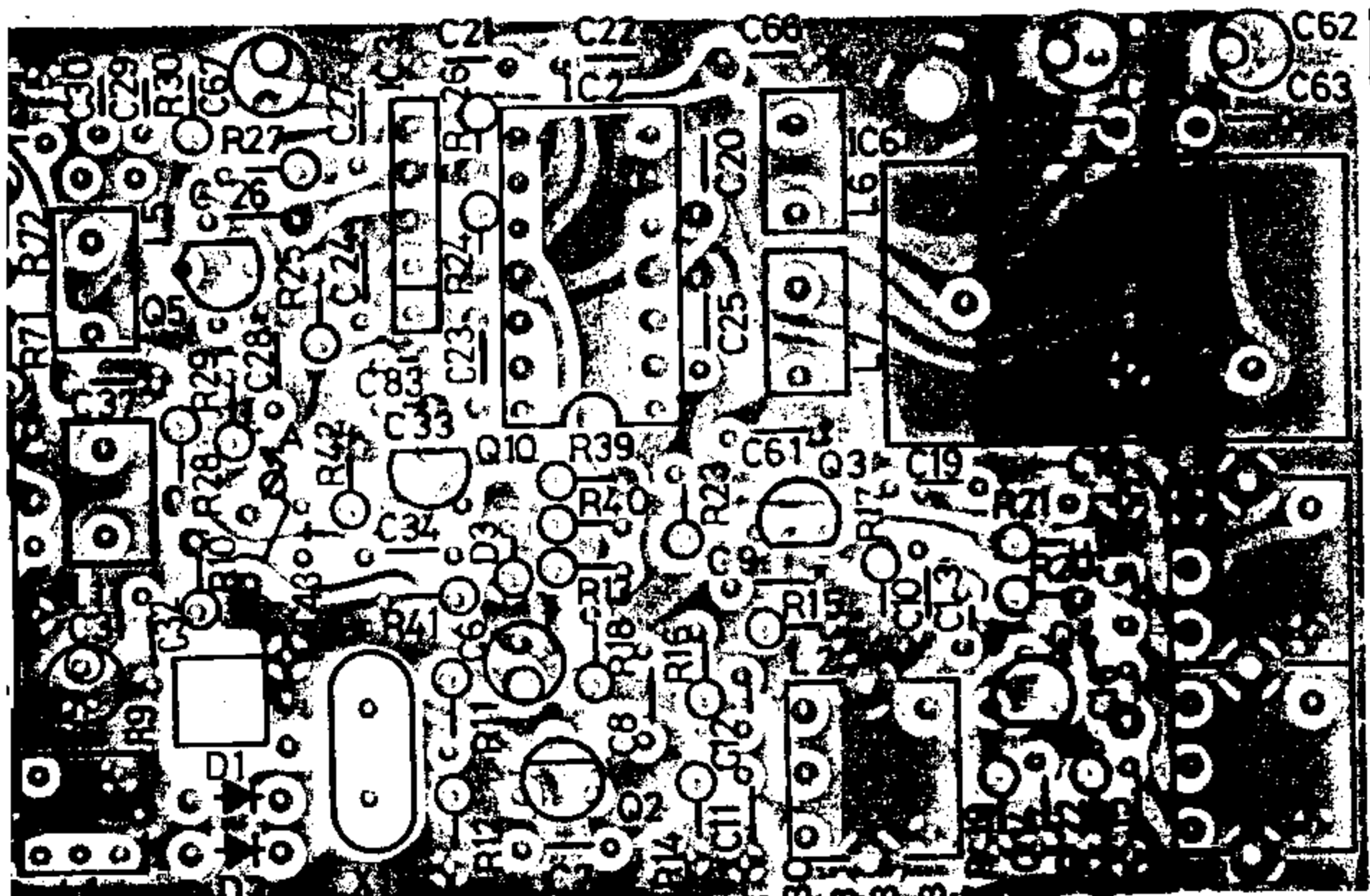

Scanned by IW1AXR
 Downloaded by
 Amateur Radio Directory

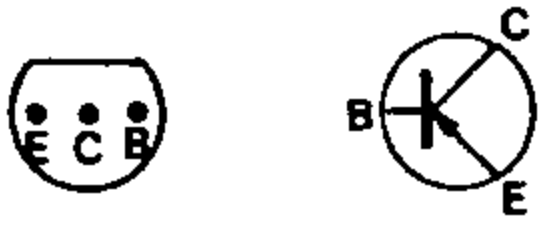
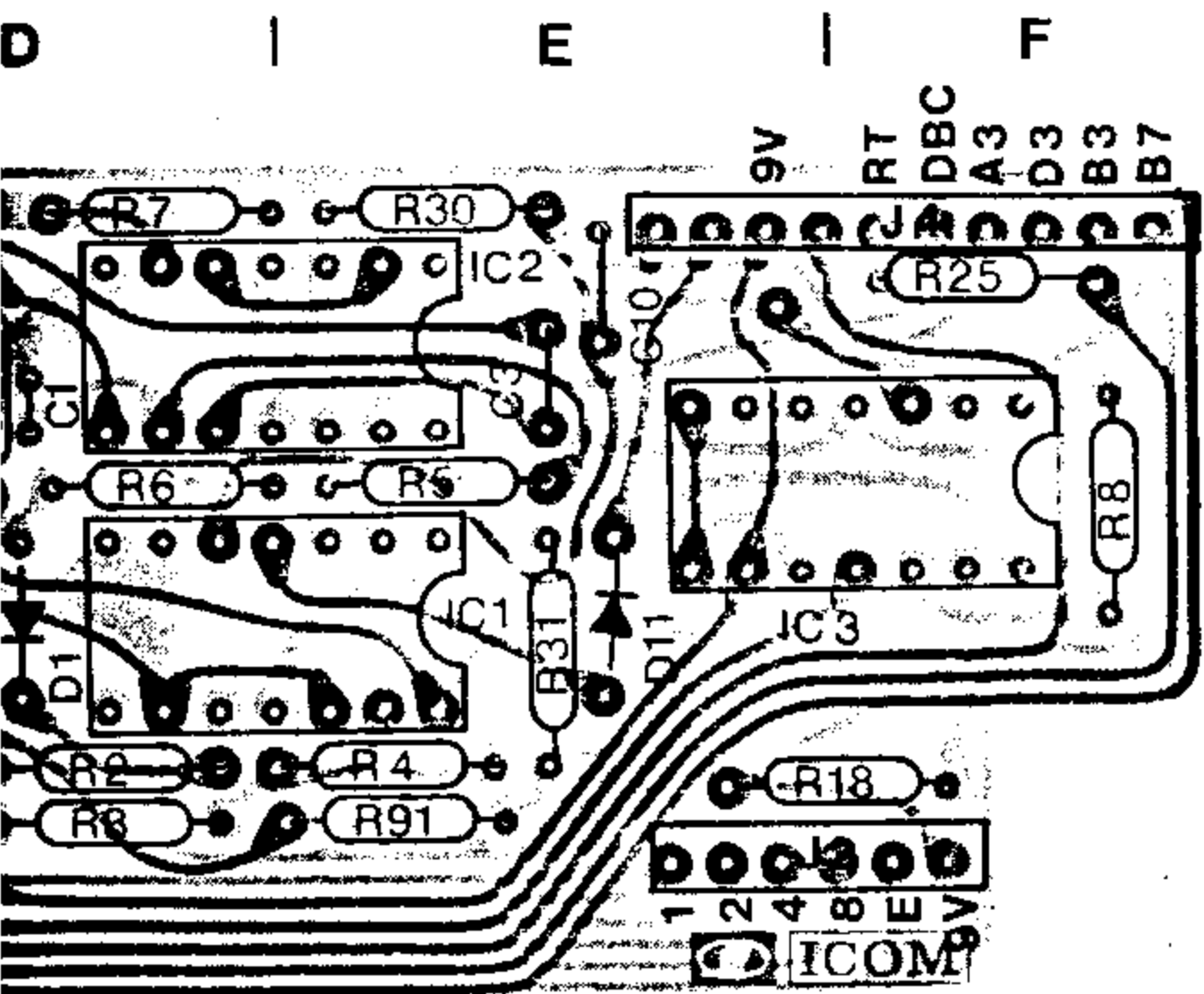

Q21-25,27

VCO UNIT

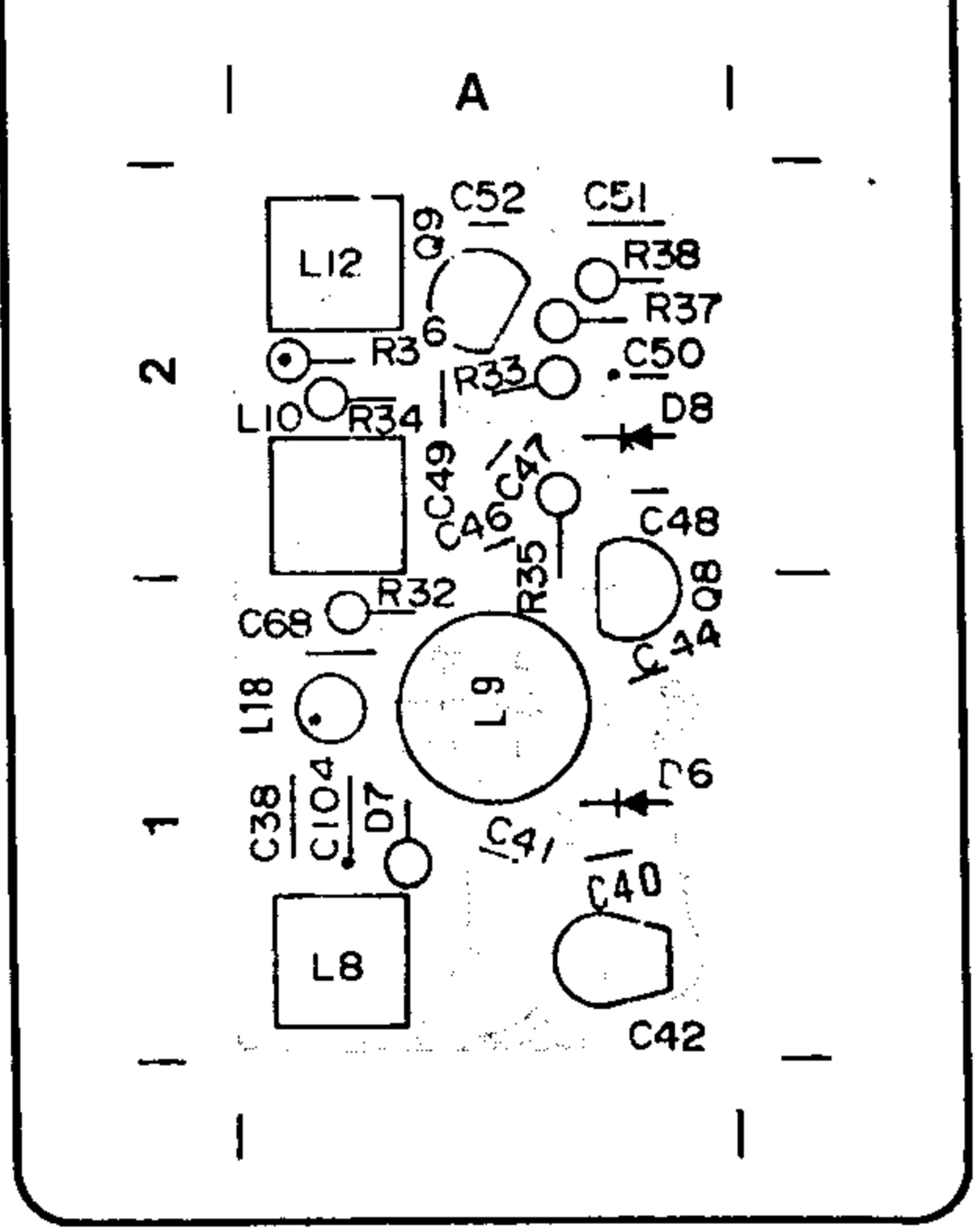

ONE CALL U

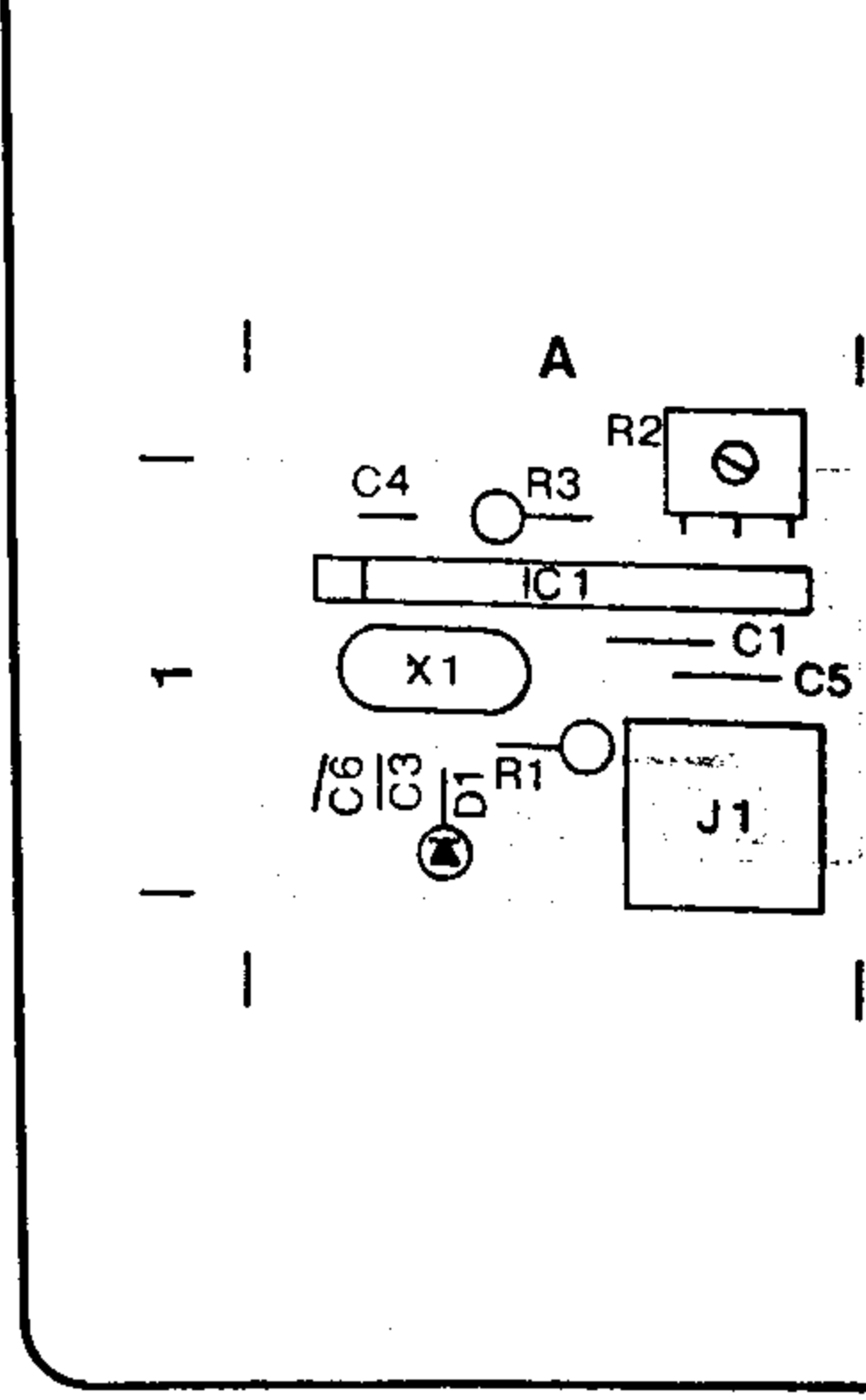

EF UNIT

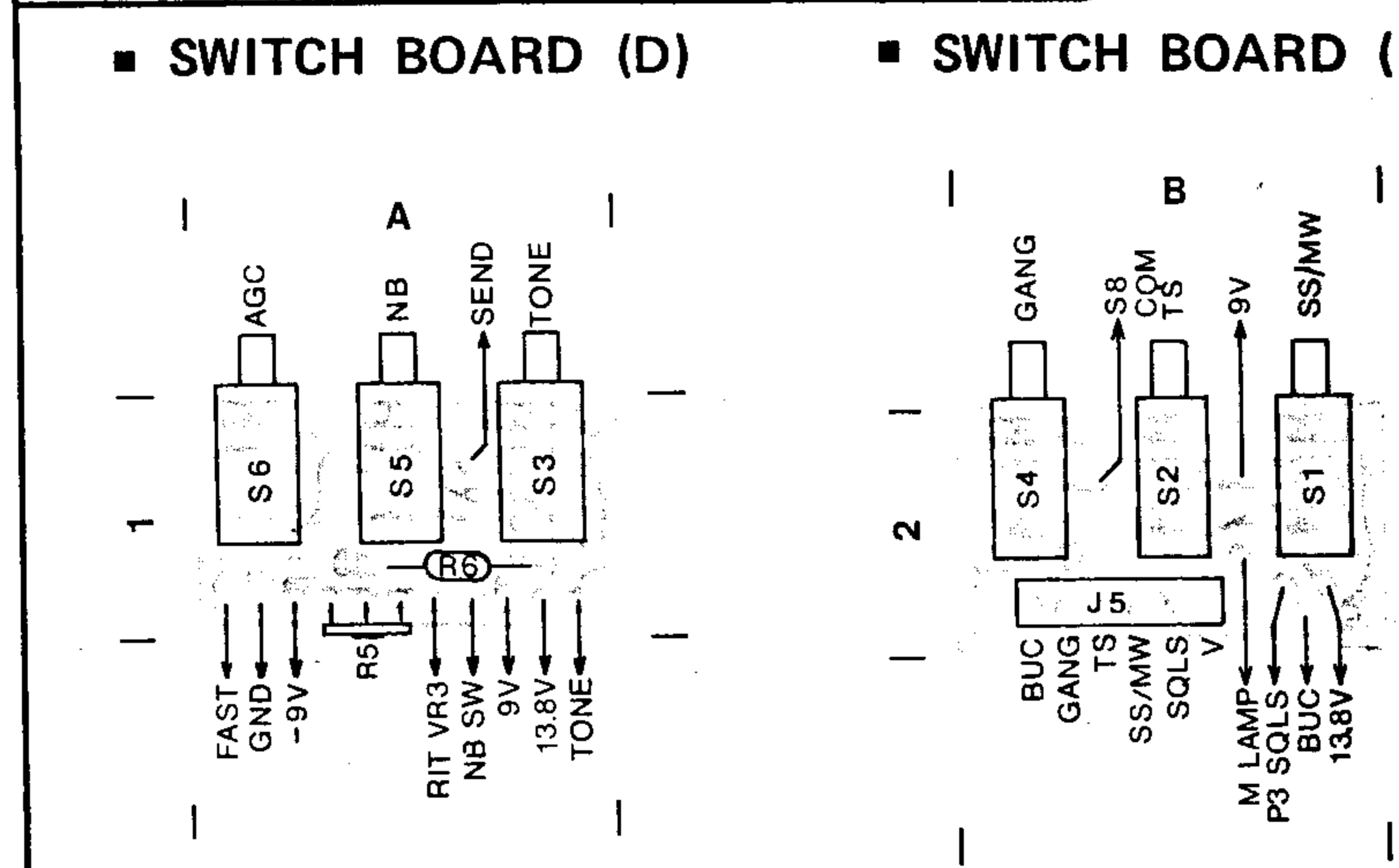

LEI BOARD

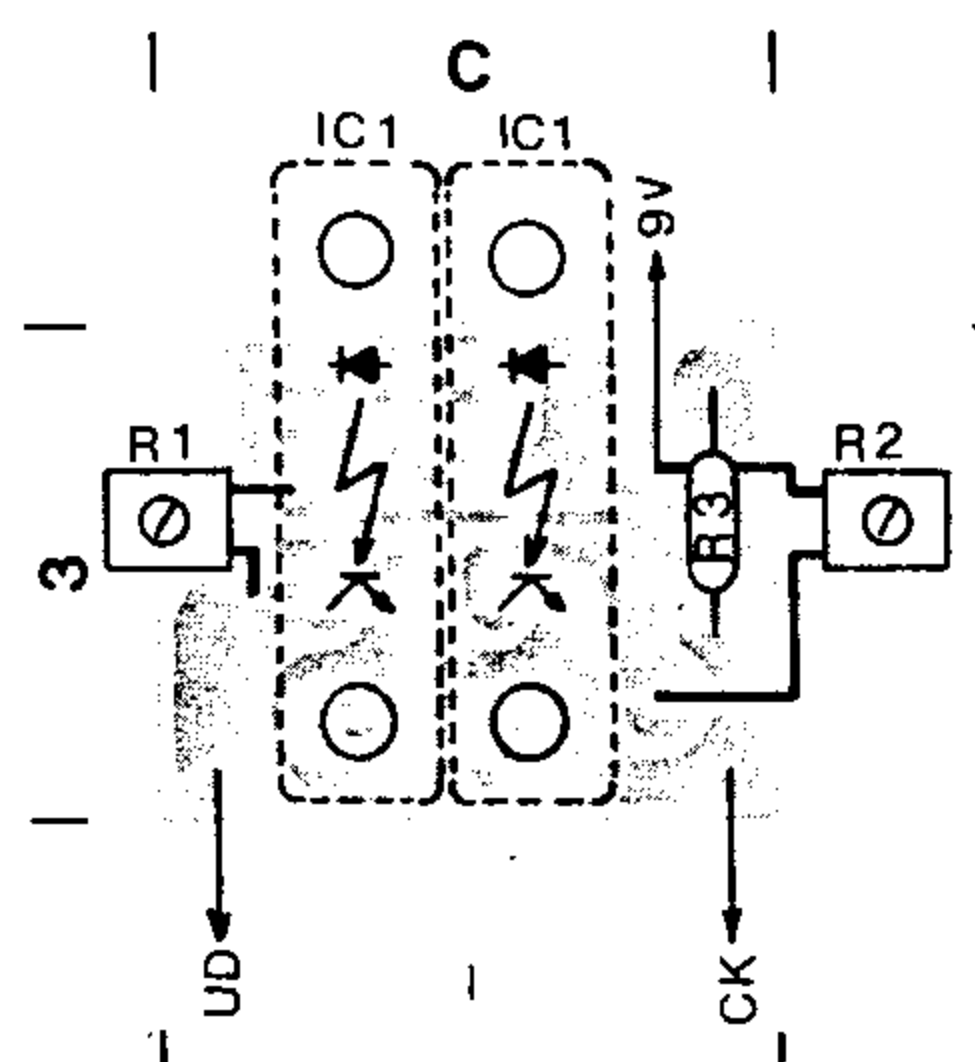

DISPLAY BOARD

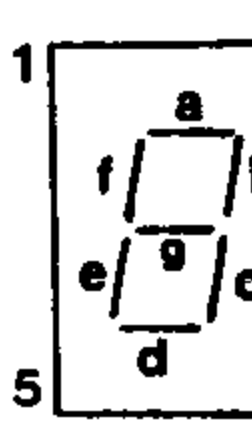
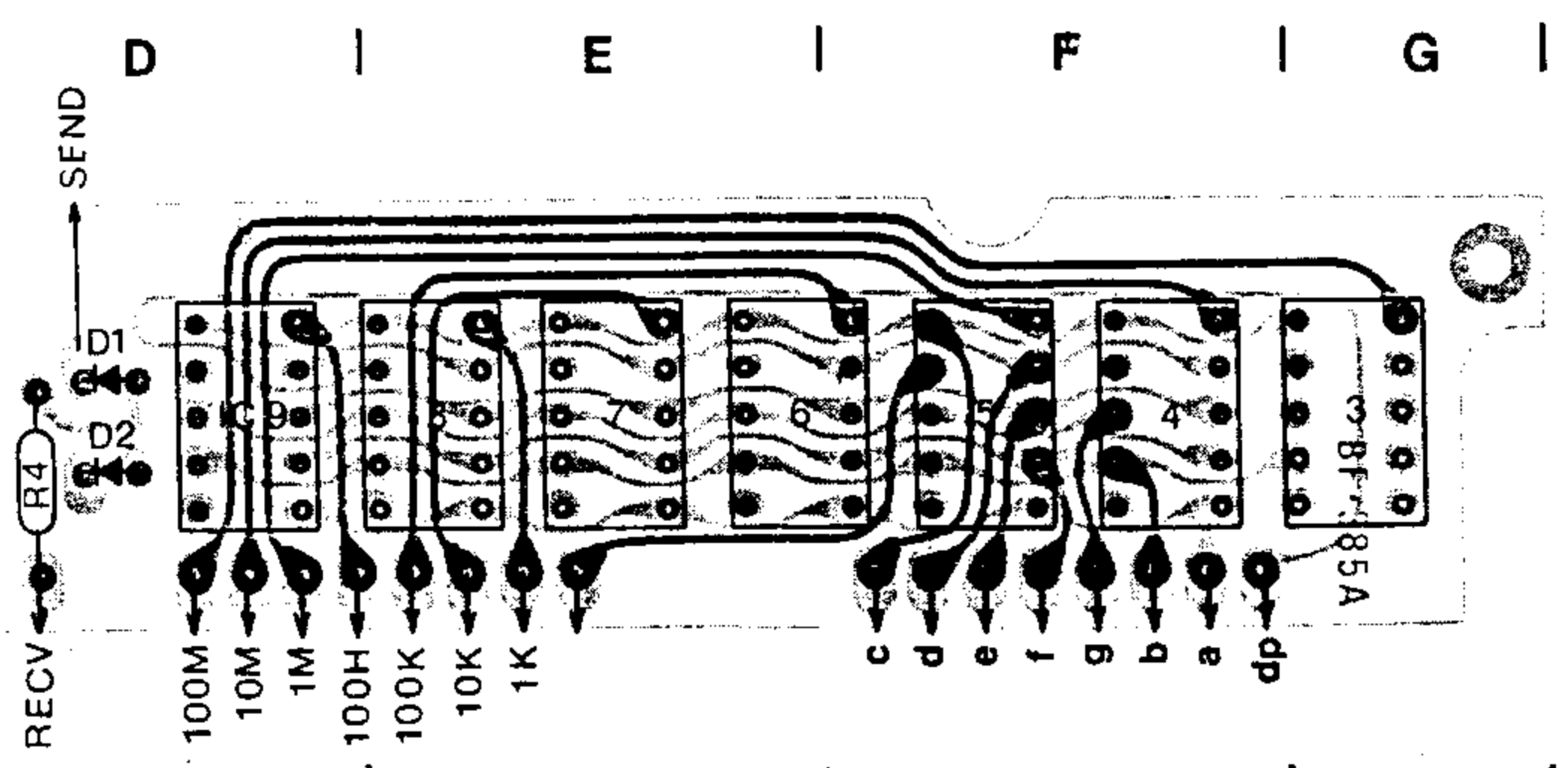

3
2
1

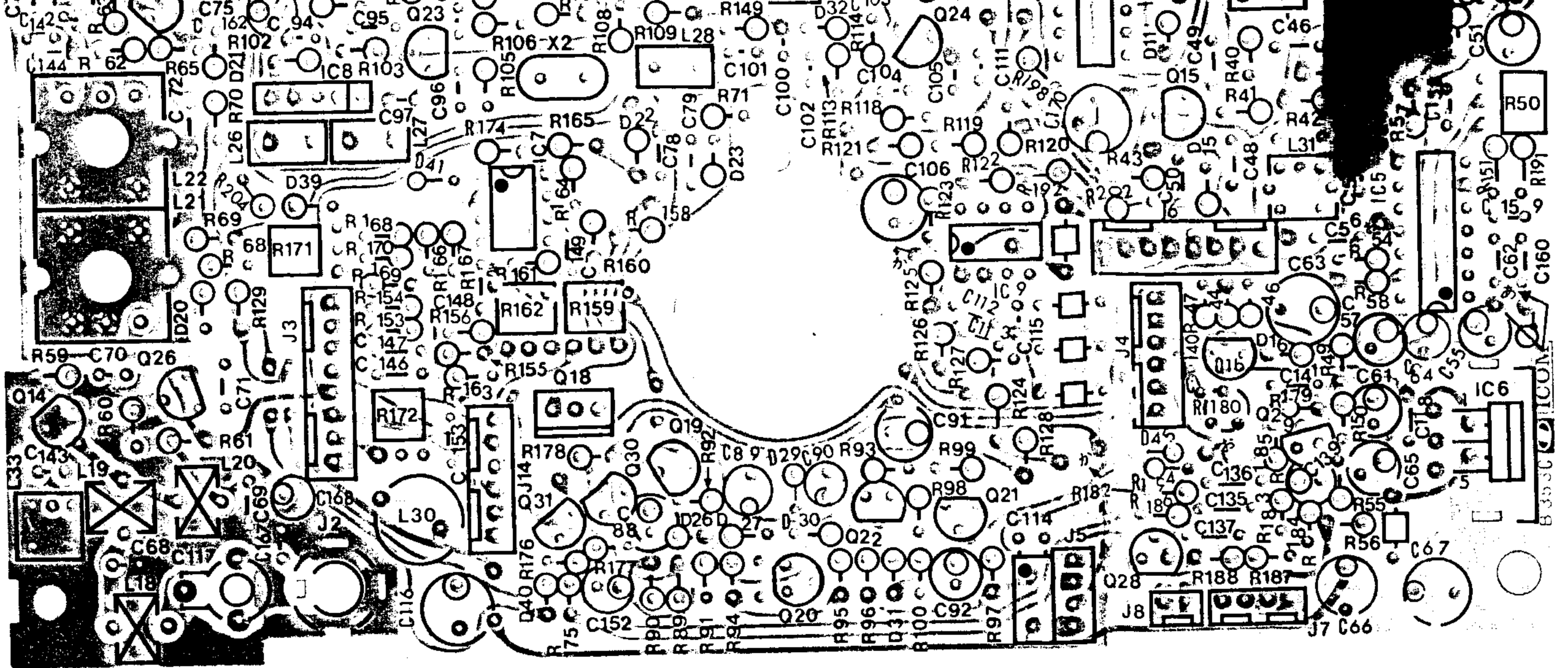

SSB UNIT

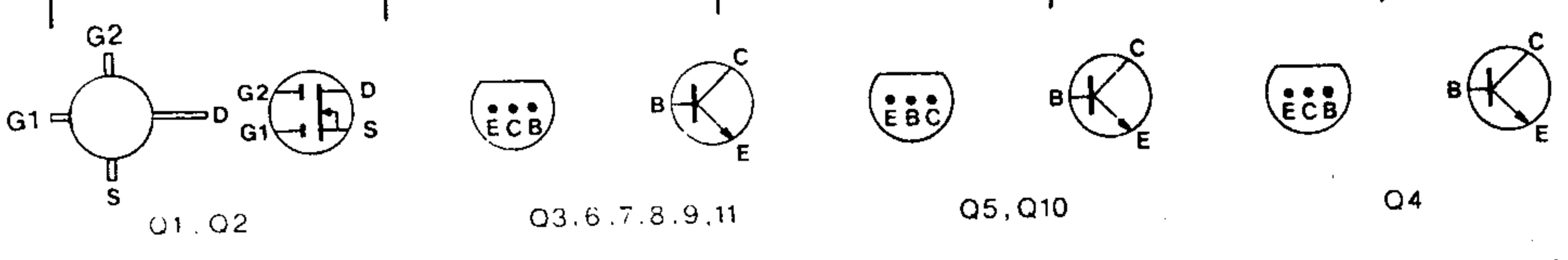
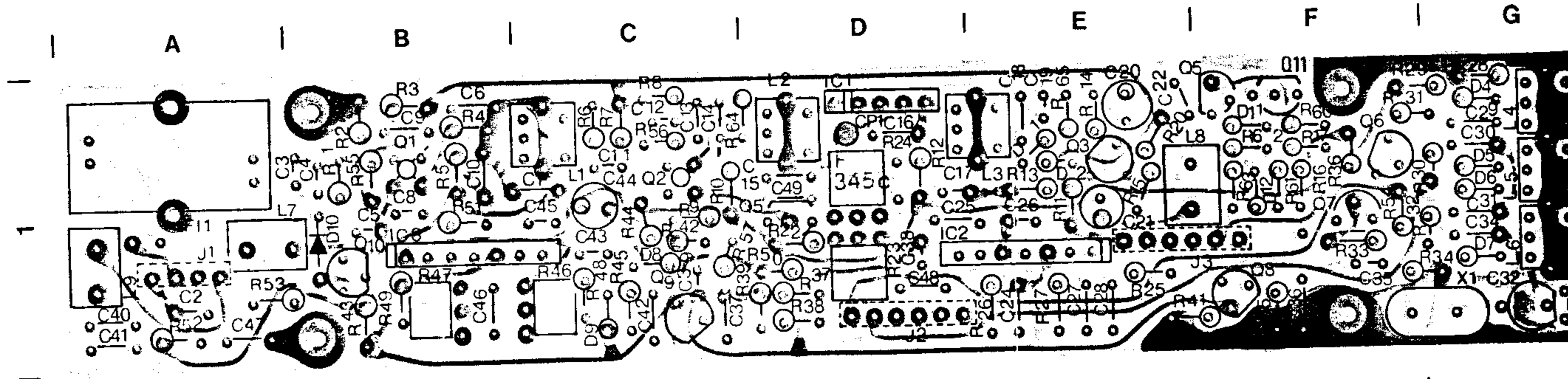

POWER AMPLIFIER UNIT

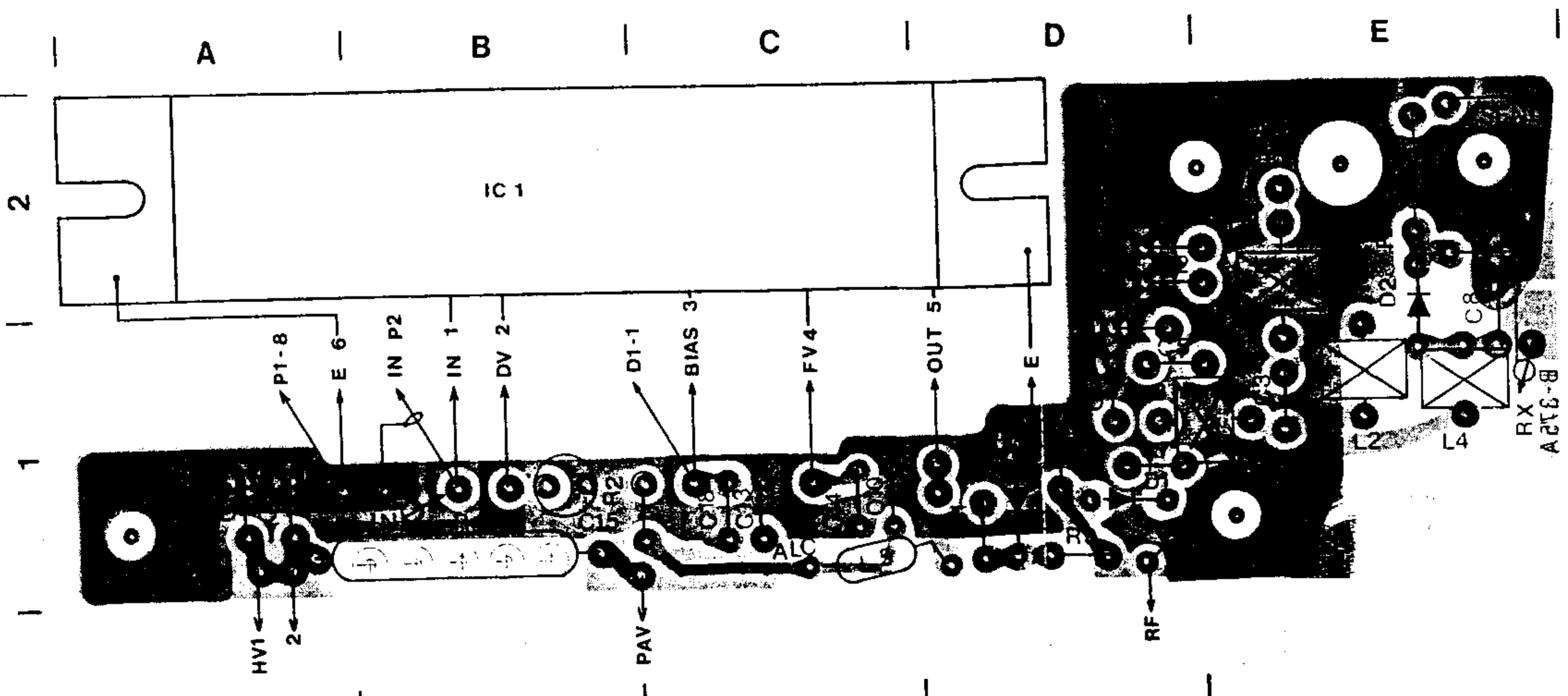

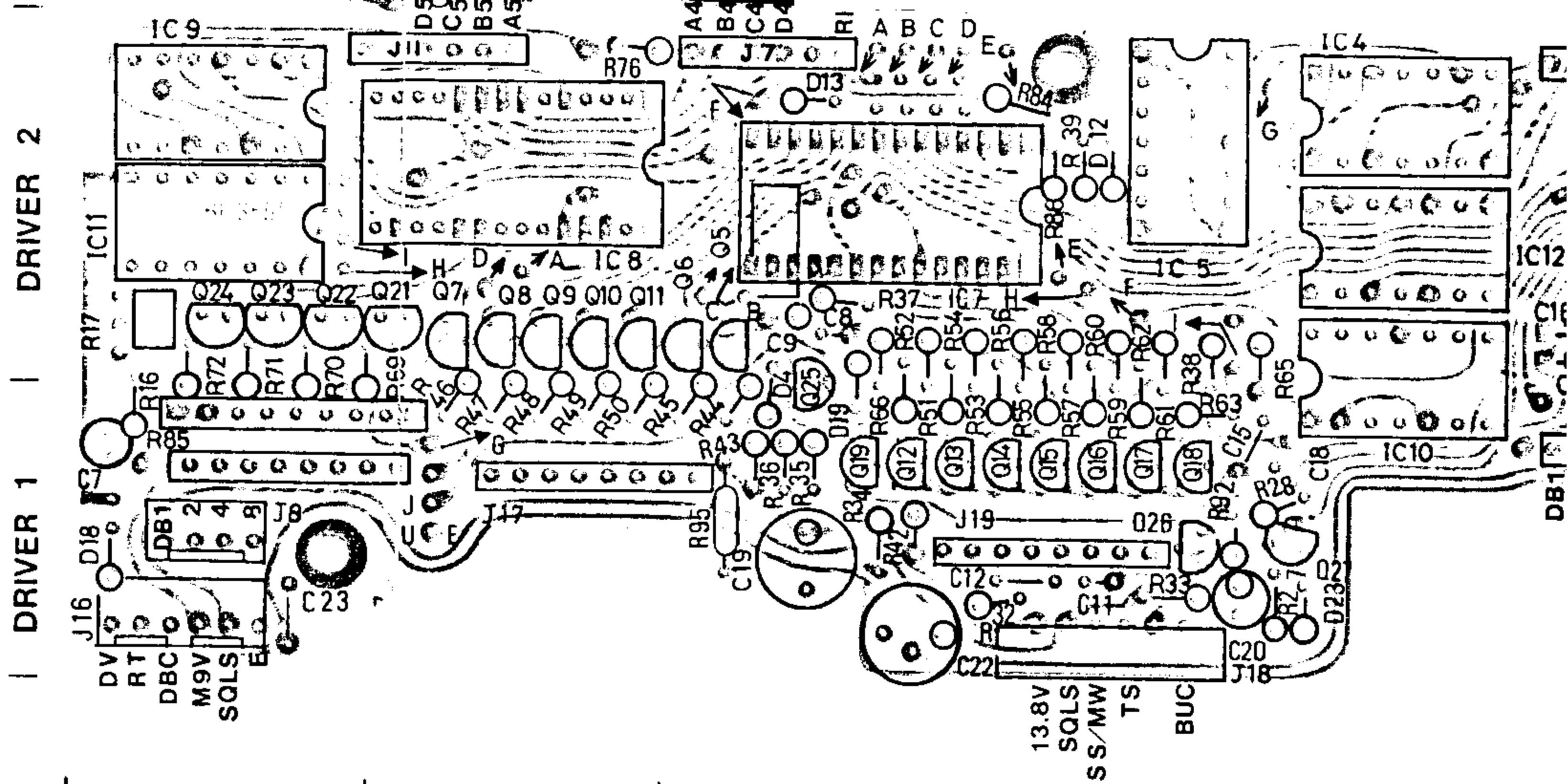
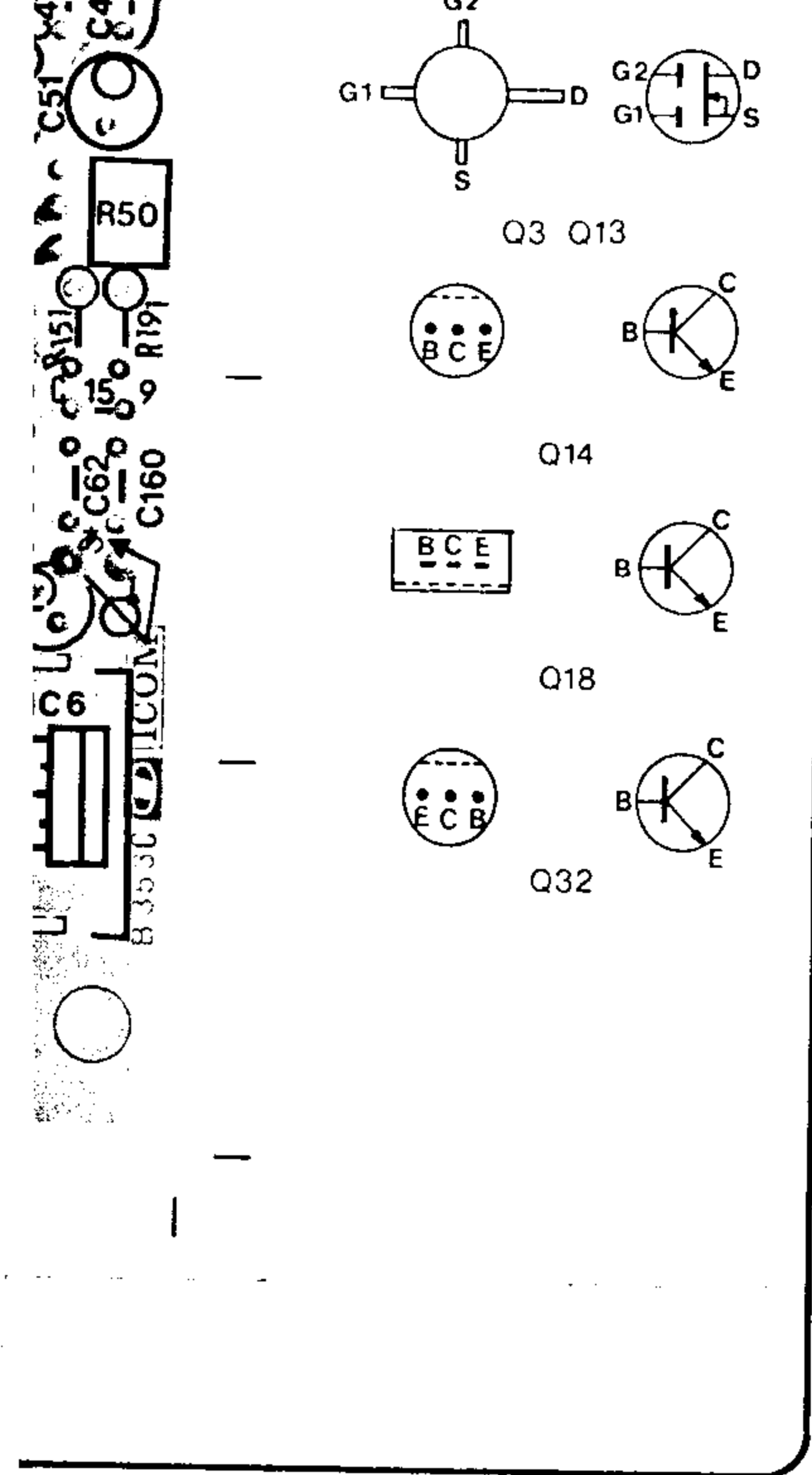

Scanned by IW1AXR
 Downloaded by
 Amateur Radio Directory

DRIVER SUB BOARD

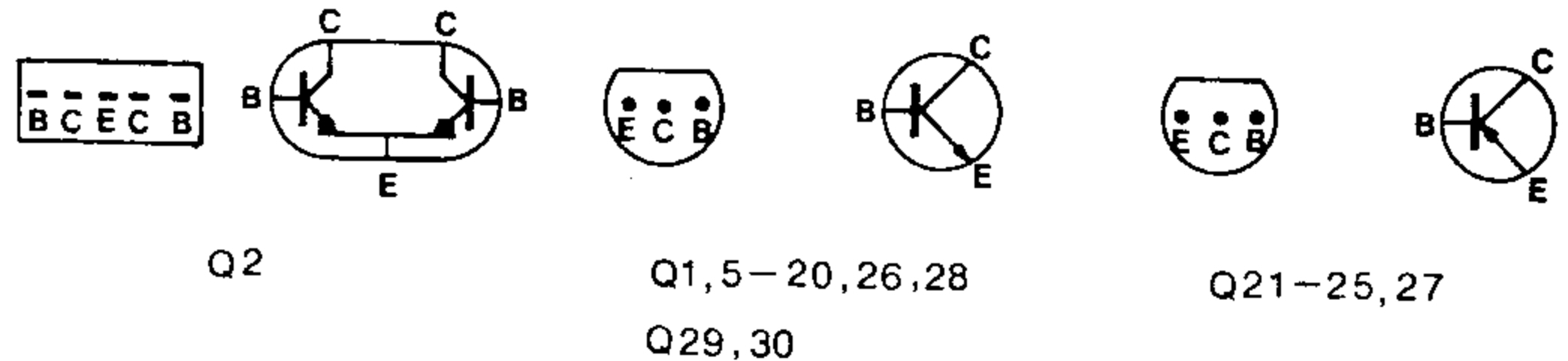
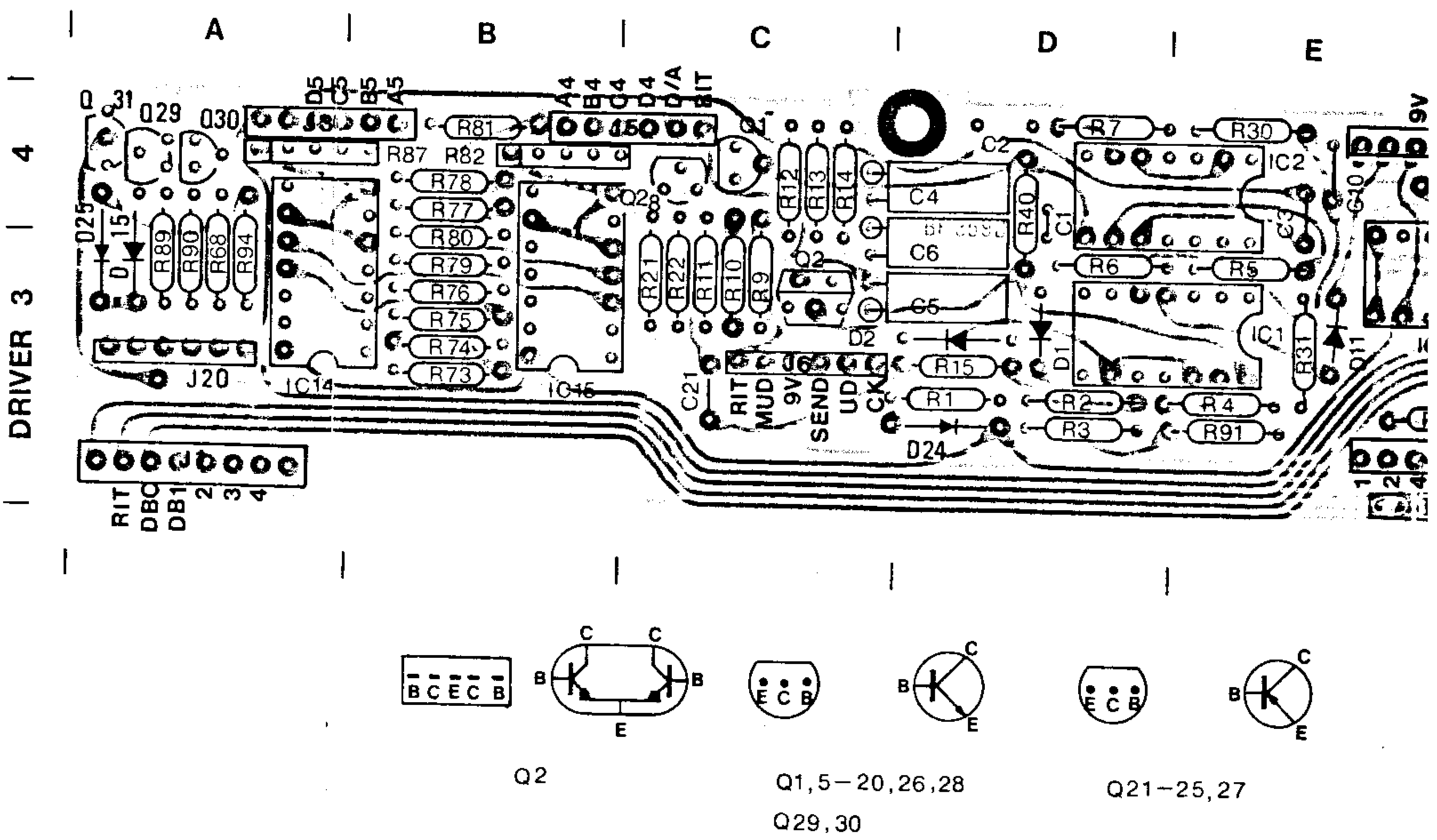
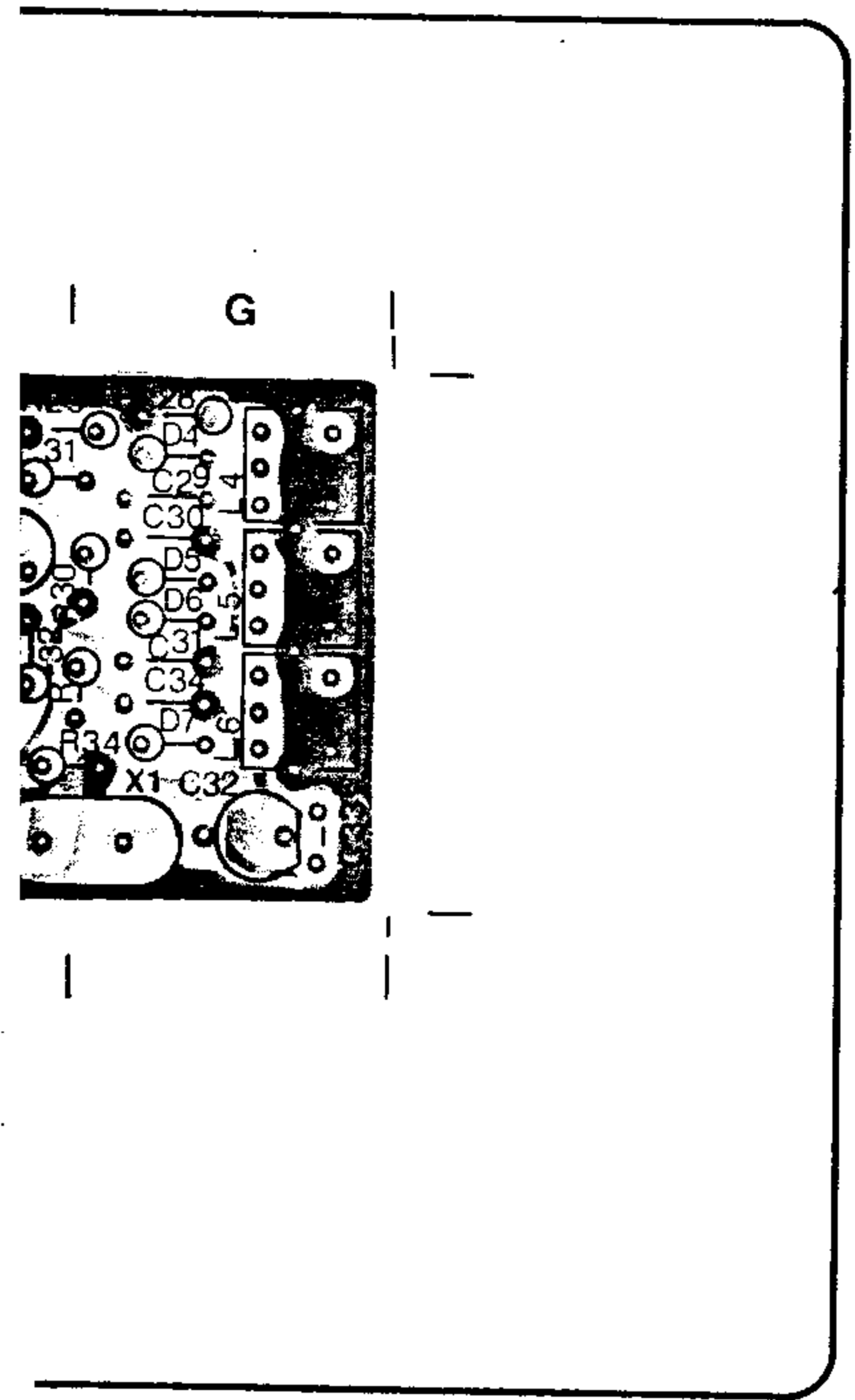

UNIT LAYOUT

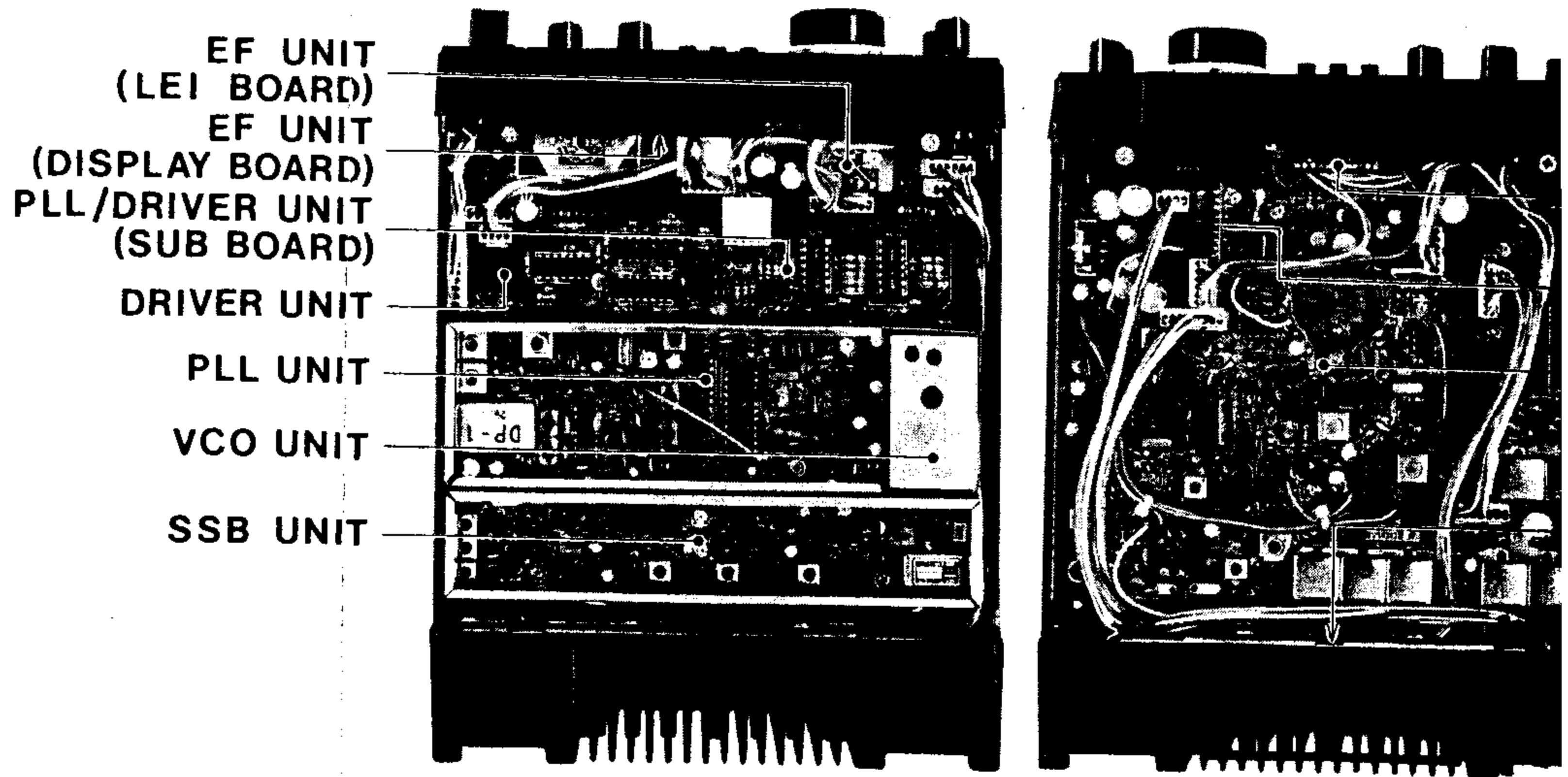

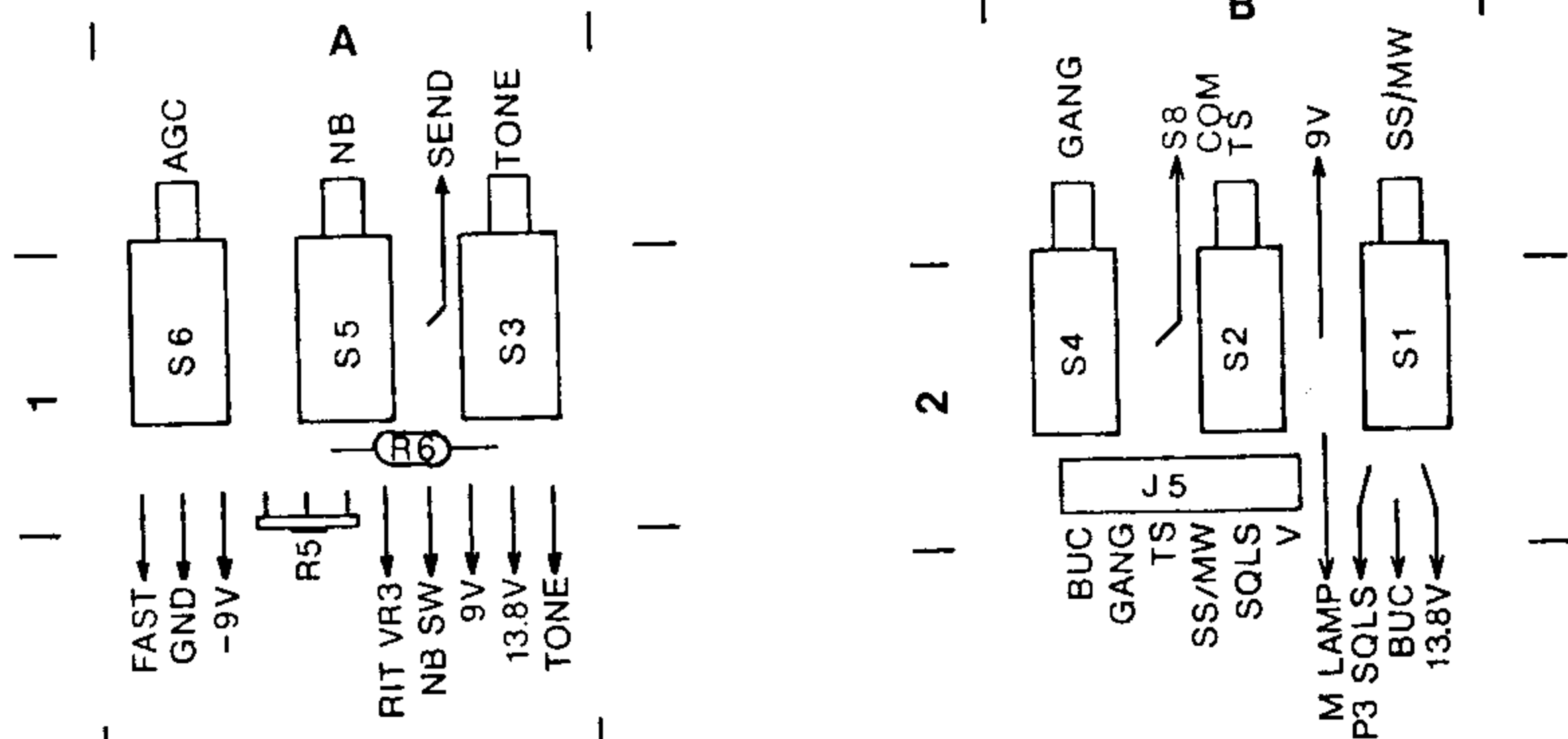
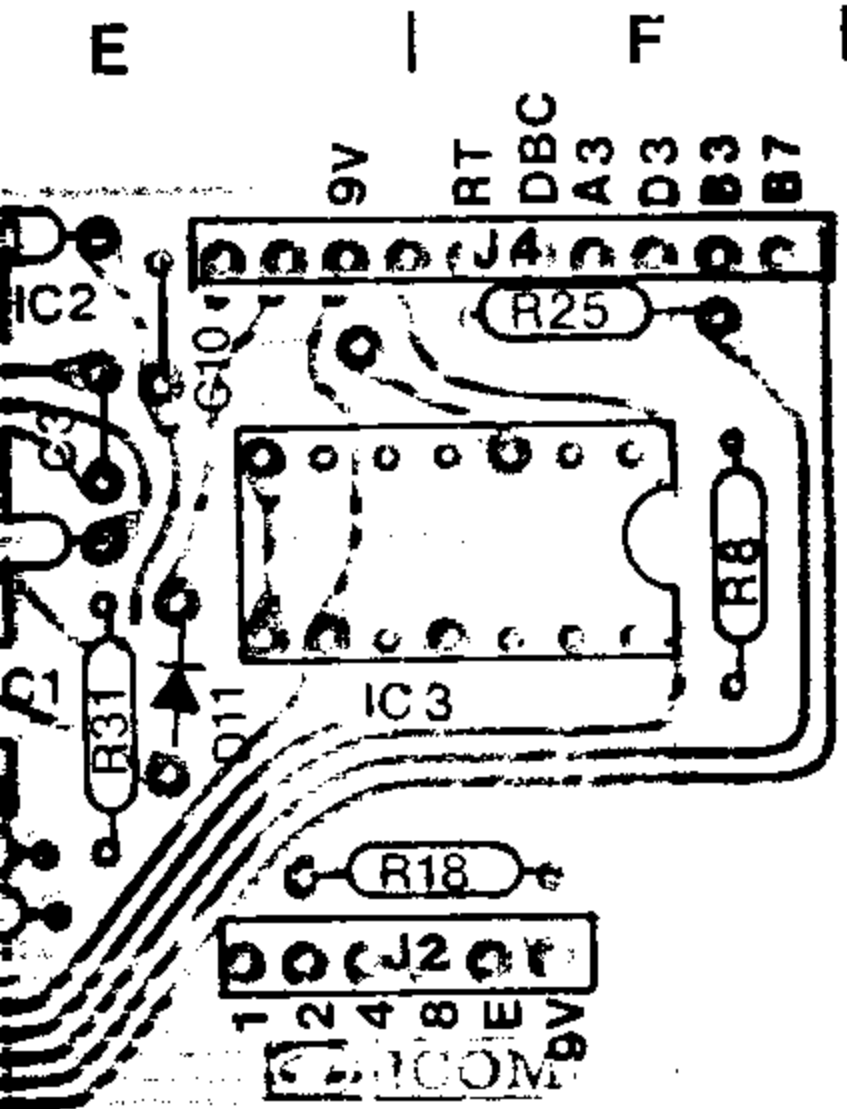
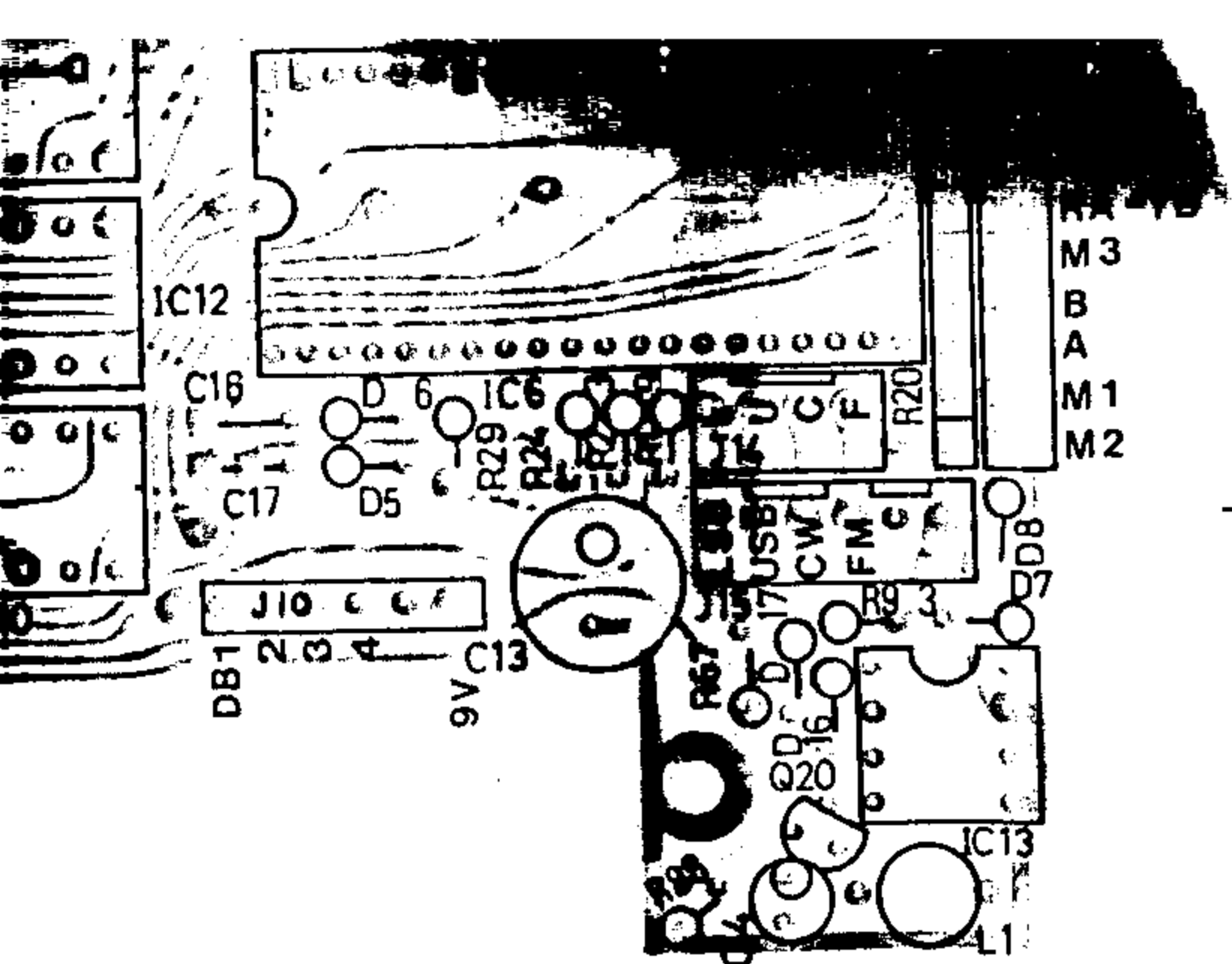

■ LEI BOARD

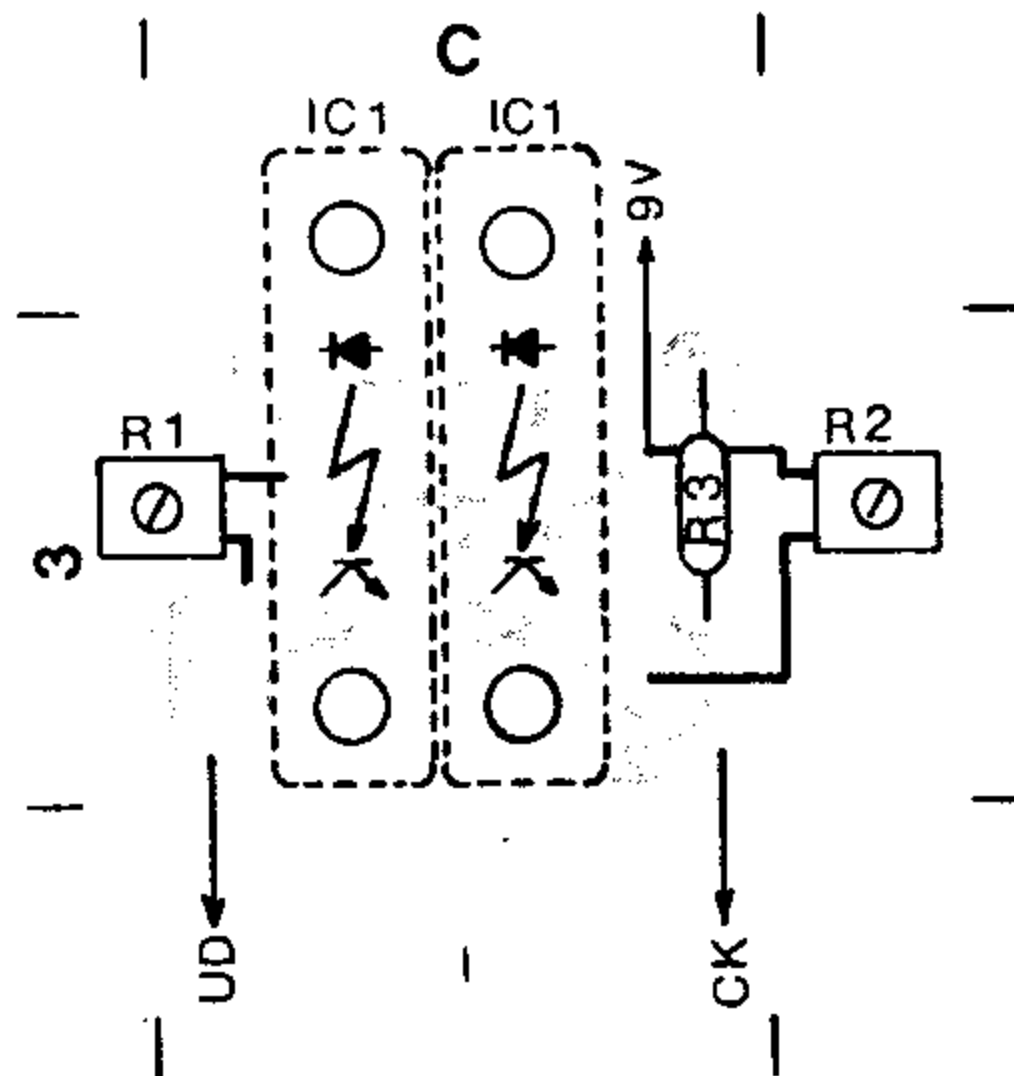

■ DISPLAY BOARD

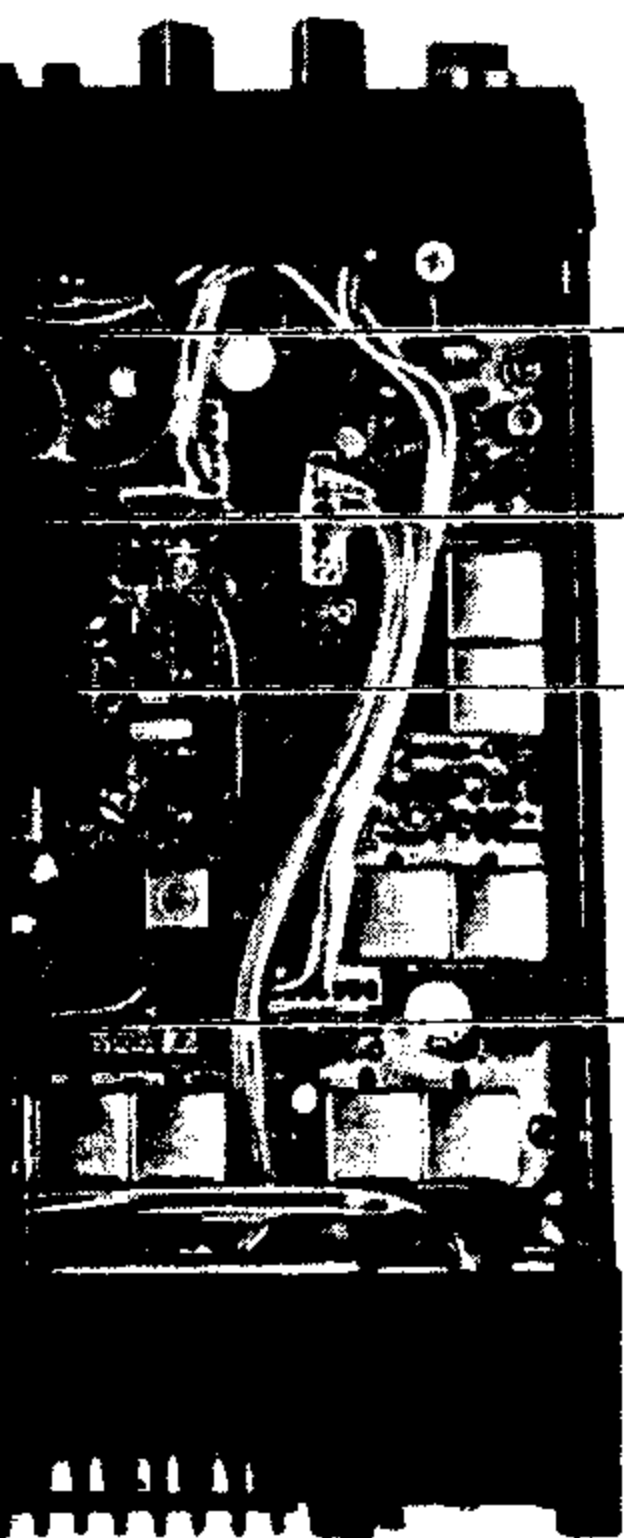
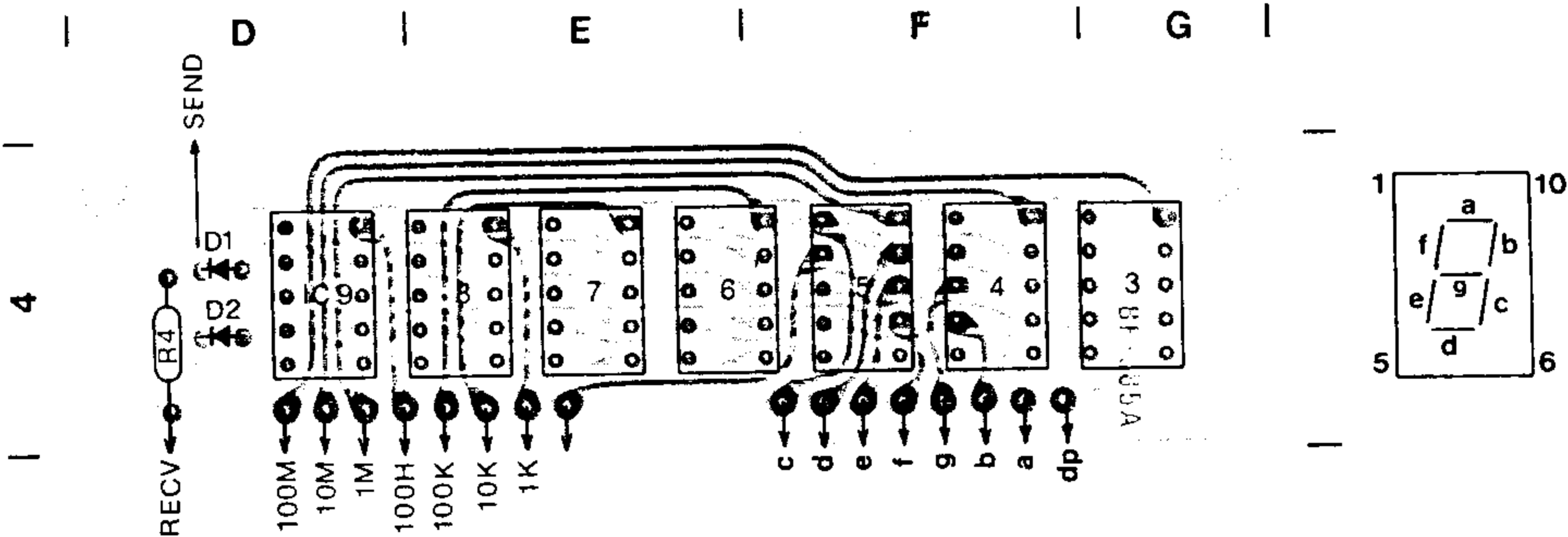

- EF UNIT
(SWITCH BOARD D-E)
- TONE CALL UNIT
(EUROPE ONLY)
- MAIN UNIT
- POWER AMPLIFIER
UNIT



ICOM INCORPORATED

Scanned by IW1AXR
 Downloaded by
 Amateur Radio Directory

Some components subject to change for an improvement without notice.