

144/430MHz DUAL BAND
IC-3200A/E
FM TRANSCEIVER

INSTRUCTION MANUAL



FOREWORD

Thank you very much for choosing this ICOM product.

The IC-3200A/E is a complete VHF/UHF FM transceiver in one small, compact package developed by ICOM which utilizes the latest computer technology and precision VHF/UHF engineering.

To fully enjoy the benefits of this high-performance transceiver, please study the operating manual thoroughly prior to operation. Also, feel free to contact an authorized ICOM dealer if you have any questions relating to the operation of this model.

TABLE OF CONTENTS

1. SPECIFICATIONS	1
2. DESCRIPTION	3
3. INSTALLATION	4
4. CONTROL FUNCTIONS.....	9
5. OPERATION	15
6. INSIDE VIEWS	27
7. TROUBLESHOOTING.....	29
8. BLOCK DIAGRAM.....	31
9. SCHEMATIC DIAGRAM.....	SEPARATE

SECTION 1 SPECIFICATIONS

1-1 GENERAL

Number of semiconductors : Transistors 49
 FETs 10
 Diodes 85

Frequency coverage &
 Channel resolution :

VERSION	BAND	FREQUENCY COVERAGE (MHz)	CHANNEL RESOLUTION (kHz)
IC-3200A U.S.A.	VHF UHF	140.0 ~ 150.0 440.0 ~ 450.0	15 or 5 25 or 5
IC-3200A VK	VHF UHF	144.0 ~ 148.0 430.0 ~ 440.0	25 or 5
IC-3200A ASIA	VHF UHF	140.0 ~ 150.0 430.0 ~ 440.0	15 or 5 25 or 5
IC-3200E EUROPE	VHF UHF	144.0 ~ 146.0 430.0 ~ 440.0	25 or 12.5

Frequency control : Microcomputer-based 5kHz steps (or 12.5kHz steps) Digital PLL synthesizer with independent dual VFO capability

Frequency stability : Within $\pm 0.001\%$

Memory channels : 10 channels with any in-band frequency programmable

Usable temperature range : -10°C to $+60^{\circ}\text{C}$
 (-14°F to $+140^{\circ}\text{F}$)

Antenna impedance : 50 ohms unbalanced

Power supply requirement : 13.8V DC $\pm 15\%$ (negative ground)
 7.5A maximum

Current drain (13.8V DC) : Transmitting
 HIGH (25W): Approx. 7.5A
 LOW (5W): Approx. 3.5A
 Receiving
 At max. audio output: Approx. 0.65A
 Squelched: Approx. 0.5A

Dimensions : 140(140)mm(W) x 50(50)mm(H) x 207(218)mm(D)
 () Dimensions include projections

Weight : 1.9kg

1 - 2 TRANSMITTER

Output power	: HIGH: 25W, LOW: 5W
Emission mode	: 16F3 (F3E 16K0)
Modulation system	: Variable reactance frequency modulation
Max. frequency deviation	: ± 5 kHz
Spurious emissions	: More than 60dB below carrier
Microphone	: 600 ohm electret condenser microphone with push-to-talk and frequency UP/DOWN switches IC-3200A (U.S.A. only): 16 key DTMF pad IC-3200E : 1750Hz tone burst unit
Operating modes	: Simplex, Semi-duplex Programmable

1 - 3 RECEIVER

Receiving system	: Double-conversion superheterodyne
Modulation acceptance	: 16F3 (F3E 16K0)
Intermediate frequencies	: 1st: 30.875MHz 2nd: 455kHz
Selectivity	: More than 15kHz at -6 dB point Less than 30kHz at -60 dB point
Sensitivity	: Less than 0.2μ V for 12dB SINAD Less than 0.4μ V for 20dB noise quieting
Audio output power	: More than 1.7W at 10% distortion with 8 ohm load
Audio output impedance	: 4 ~ 8 ohms

NOTE: Specifications are approximate and are subject to change without notice or obligation.

SECTION 2 DESCRIPTION

***COMPACT VHF/UHF MOBILE**

The IC-3200A/E measures only 50 millimeters high by 140 millimeters wide by 207 millimeters deep, yet contains a full-featured 144/440MHz (430MHz) transceiver. Through careful ICOM engineering, the IC-3200A/E includes a built-in speaker to facilitate installation; resulting in a compact but complete package.

Access to all transceiver functions is available with surprisingly few front panel controls through use of convenient, double function keys.

***EASY-TO-READ DISPLAY**

The new liquid-crystal display with a soft green illumination provides good operating frequency visibility even in sunlight, and indicates VFO A/B, MEMORY status, DUPLEX mode and S/RF meter readings.

***10 MEMORIES AVAILABLE**

The IC-3200A/E has ten memories to store the receive frequency, the transmit offset frequency, the offset direction and the subaudible tone.

***MULTI-PURPOSE SCANNING**

The Programmed Scan function allows scanning between two programmed frequencies while the Memory Scan function allows monitoring of ten different memory channels. In addition, unwanted memory channels may be skipped when using Memory Scan to reduce the total scan time.

***38 SUBAUDIBLE TONE ENCODER**

(U.S.A. version only)

The IC-3200A comes equipped with a ready-to-use subaudible tone encoder fully controllable from the front panel. Each tone may be selected by the main tuning knob and stored in memory along with the operating frequency.

***SPEECH SYNTHESIZER**

As an added feature, the IC-3200A/E has an optional speech synthesizer available to verbally announce the receive frequency. This allows the operator to know which frequency the receiver is tuned to without looking at the frequency display.

***HIGH OUTPUT POWER**

Though small in size, the IC-3200A/E still provides 25 watts of output power on both the 144MHz and 440MHz (430MHz) bands.

***SINGLE TRANSMISSION LINE**

The IC-3200A/E is equipped with only one antenna connector although it is a dual band radio, due to the built-in duplexer which provides more than 40dB of isolation. This both simplifies and lowers the cost of antenna installation.

***EASY OPERATION**

The IC-3200A/E comes with an UP/DOWN hand microphone to allow frequency changes smoothly and easily, for example, while driving.

***RAPID FREQUENCY CHANGES**

Two independent, programmable CALL FREQUENCY memories are available which allow instant frequency shifts by pushing one button.

SECTION 3 INSTALLATION

3-1 UNPACKING

Carefully remove your transceiver from the packing carton and examine it for signs of shipping damage. Notify the delivering carrier or dealer immediately, stating full details, should any damage be apparent. It is recommended you keep the shipping cartons for storing, moving or reshipping the transceiver if necessary. Accessory hardware, cables, etc. are packed with the transceiver. Make sure you have removed all equipment and parts before discarding the packing material.

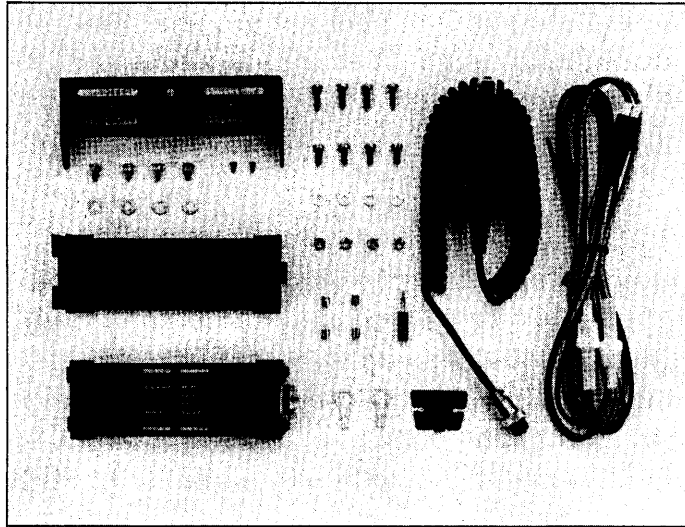

1. Microphone*	1	8. Gimp screws.	4
2. Microphone hook	1	9. Flat washers	8
3. DC power cord	1	10. Mounting screws	8
4. Spare fuses.	2	11. Additional bracket screws	2
5. External speaker plug.	1	12. Mounting screw nuts	4
6. Mounting bracket	1	13. Battery terminal lugs	2
7. Angle bracket.	1		

* The IC-3200A (U.S.A.) is supplied with an HM-14 (DTMF encoder), the IC-3200E (Europe) is supplied with an HM-15 (1750Hz tone burst unit), and the other versions are supplied with an HM-12.

3-2 LOCATION

Where you place the transceiver in your automobile is not critical and should be governed by convenience and accessibility. There are many mounting possibilities since the unit is so compact. In general, the mobile mounting bracket provides some guide as to placement. Any location where the transceiver can be mounted with metal screws, bolts or pop-rivets would be suitable.

3-3 VEHICLE INSTALLATION

Use the following method to install the transceiver after choosing the installation location.

1. Place the angle bracket in the mounting location to mark the bracket's screw holes.
2. Drill the holes.
3. Mount the brackets and tighten the screws as shown in the figure.

■ VEHICLE INSTALLATION RECOMMENDATIONS

1. Install the transceiver and brackets securely to minimize physical vibration.
2. To remove the transceiver, lift upward on the bracket latch and lower the bottom half of the mounting bracket.
3. The installation angle of the IC-3200A/E can be varied by about 18 degrees to provide the best visibility.
4. Loosen one screw on each side of the mounting bracket nearest the faceplate of the transceiver, and tilt the unit to the best angle.

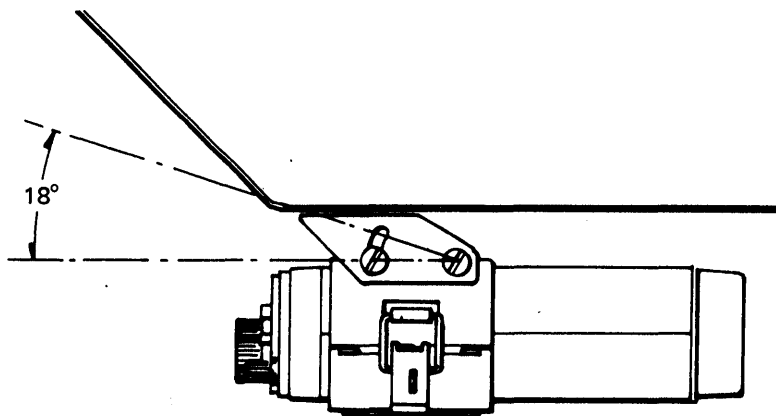
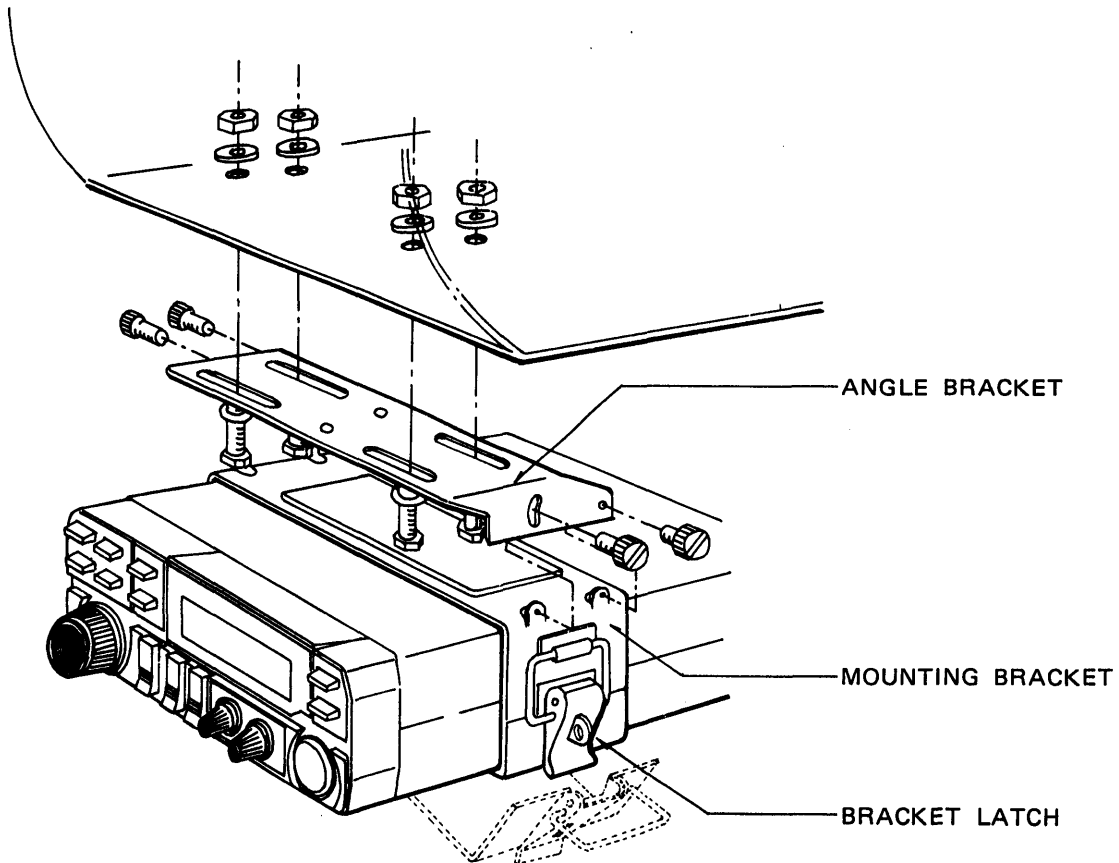

3-4 POWER REQUIREMENTS

The transceiver is supplied ready to operate from any regulated 13.8 volt DC, 7.5 ampere, negative ground source. An automobile 12 volt, negative ground system is usually more than adequate; however, the condition of the vehicle's electrical system must be good. Items such as low battery, worn generator/alternator, poor voltage regulator, etc., impairs both the transceiver and the vehicle operation. High noise or low voltage are results of the above deficiencies. Make certain that any AC power supply used is adequately voltage and current regulated. A low voltage condition while under load produces unsatisfactory results since receiver gain and transmitter output are reduced.

CAUTION: Voltages greater than 15 volts DC will damage your transceiver. Check the source voltage before connecting the power cord.

Included with your transceiver is a DC power cable with plug attached. The red wire is for the positive (+) and the black wire is for the negative (-) power terminals. It is best to connect these wires directly to the battery posts, if possible, since this arrangement eliminates random noise and transient spikes sometimes found in an automobile electrical system. Otherwise, use the most convenient B+ terminal in the interior of the vehicle and the frame of the car. Remember, this transceiver only operates from a negative ground; it cannot be powered by an automobile with a positive ground system. Simply insert the power plug into the matching power connector on the rear of the transceiver after making the power system connections.

* POWER CABLE CONNECTIONS FOR VEHICLES.

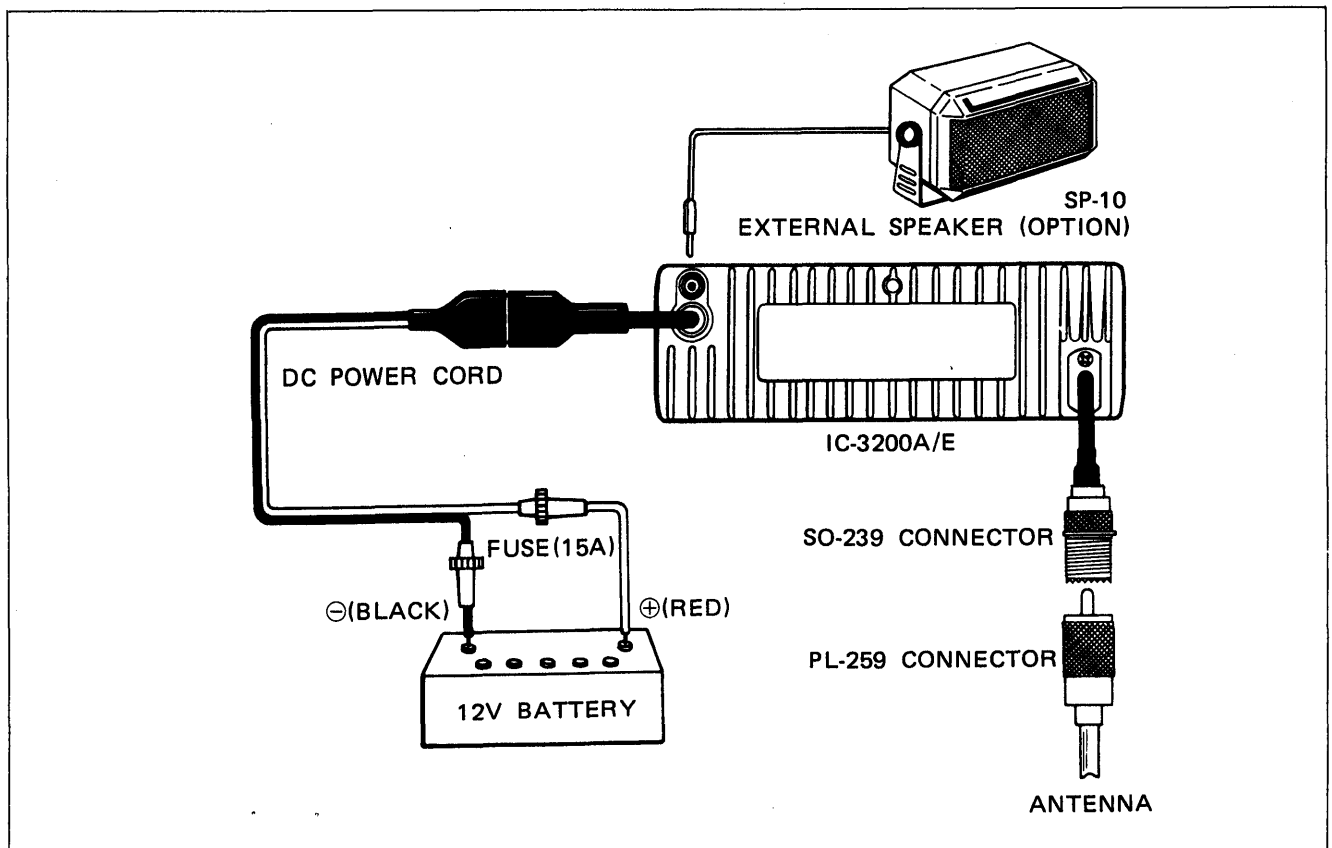

NOTE 1: Do not use the cigarette lighter to avoid the possibility of interruptions to the power source.

NOTE 2: The DC power cable may not be connected directly to a 24 volt battery.

3-5 ANTENNA

The single, most important item that influences the performance of any communication system is the antenna. For this reason, a high-quality, 50 ohm gain antenna is recommended whether in a fixed or mobile situation. The extra investment in a gain antenna is well worth the expense.

Follow the antenna manufacturer's instructions when installing and tuning your mobile or fixed antenna. Use a high quality VSWR meter designed for VHF/UHF applications. Furthermore, tune a mobile antenna with the vehicle engine running slightly above normal idling speed to ensure the transceiver receives the correct voltage level.

The IC-3200A/E has a duplexer with more than 40dB of isolation installed in the radio. Therefore, it is not necessary to have two separate antennas, one for 144MHz and one for 440MHz (430MHz), even when operating on both bands. A single dual band antenna performs well. A duplexer and adapters, as shown in the figure, are necessary if a different antenna is used on each band independently.

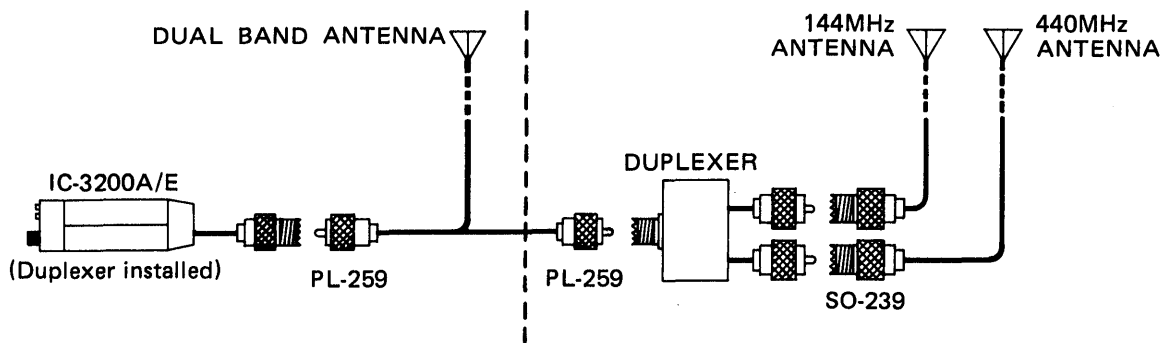

The IC-3200A/E is designed for use with a 50 ohm antenna, therefore, use only transmission line with the same impedance for best performance. Remember, coaxial cable loss increases rapidly as the operating frequency increases in the VHF/UHF range. Use low loss cable and keep the transmission line as short as practical.

■ INSTALLING PL-259 CONNECTORS

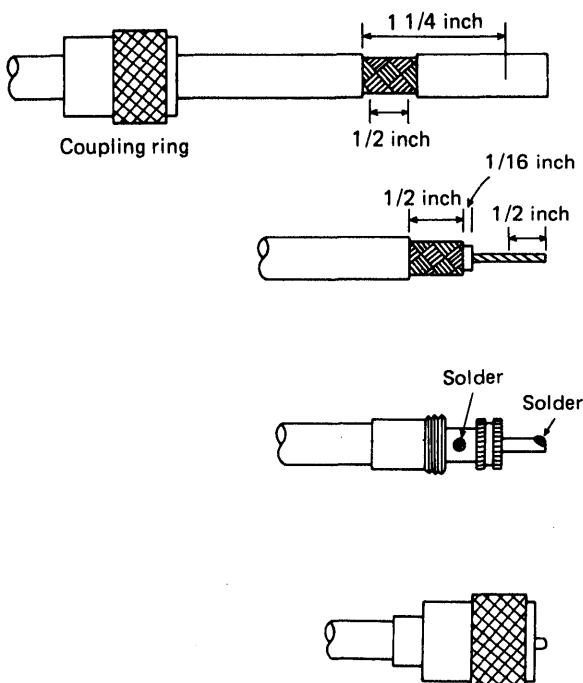

1. Slide the coupling ring over the coaxial cable.
2. Strip the cable as in the figure, and tin about one-half inch of the shield conductor.
3. Remove the outer plastic casing and strip the center conductor insulation as in the figure. Tin the center conductor.
4. Slide the connector body onto the cable end and solder.
5. Screw the coupling ring onto the connector body.

3-6 BASE STATION INSTALLATION

The PS-45 DC power supply is recommended for a base station power source. Ensure the output voltage is 13.8 volts and the current rating is 7.5 amperes if using other manufacturers' power supplies.

OPTION

BASE STATION POWER SUPPLY PS-45 (13.8V, 8A)

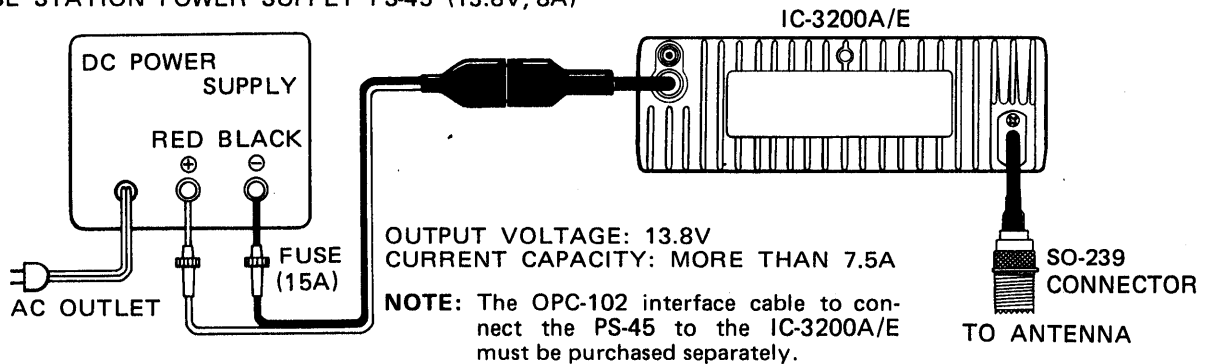

■ MICROPHONE

A high-quality electret condenser microphone is supplied with your transceiver. Merely plug it into the receptacle on the front panel. When using different microphones, check that they have the correct output level. Use particular care when wiring other microphones as the transceiver internal switching system relies on this wiring. Refer to the schematic for the proper connections.

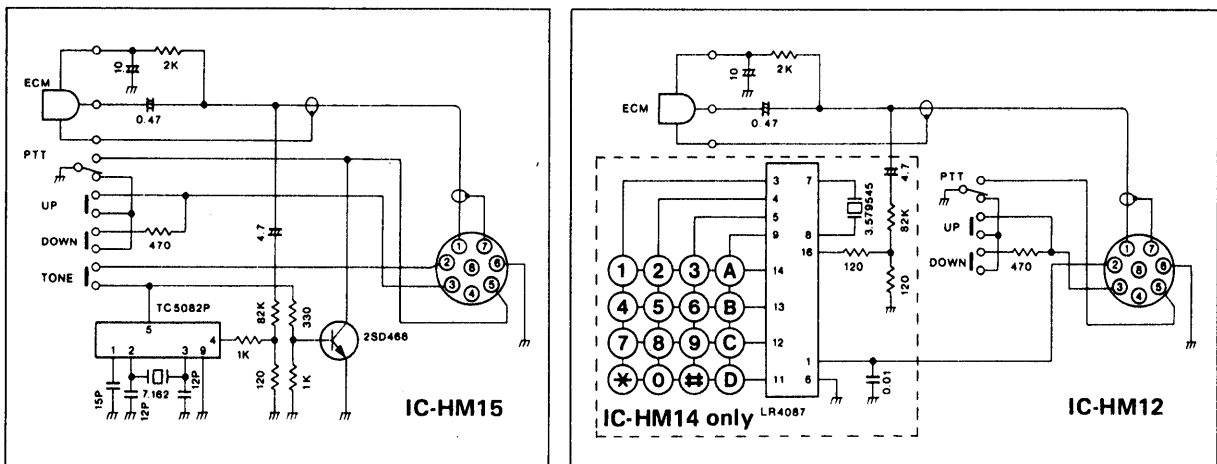

■ EXTERNAL SPEAKER

An external speaker plug is supplied with your unit to facilitate the use of other speakers. The external speaker impedance should be 4 - 8 ohms, and plugging in this speaker disables the internal speaker. The IC-SP4 and SP-10, small, high-quality communication speakers, are available for mobile use. The IC-SP3 is available for base station use. A 4 ~ 16 ohm headset may be utilized as well.

(External speaker connection)

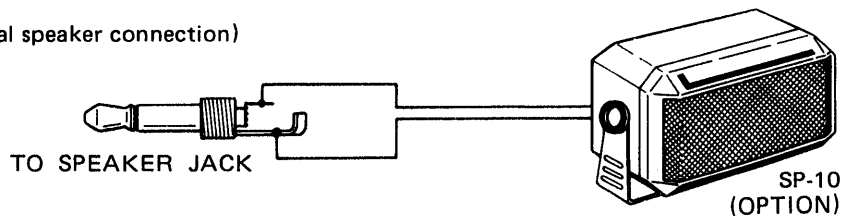

SECTION 4 CONTROL FUNCTIONS

4-1 FRONT PANEL

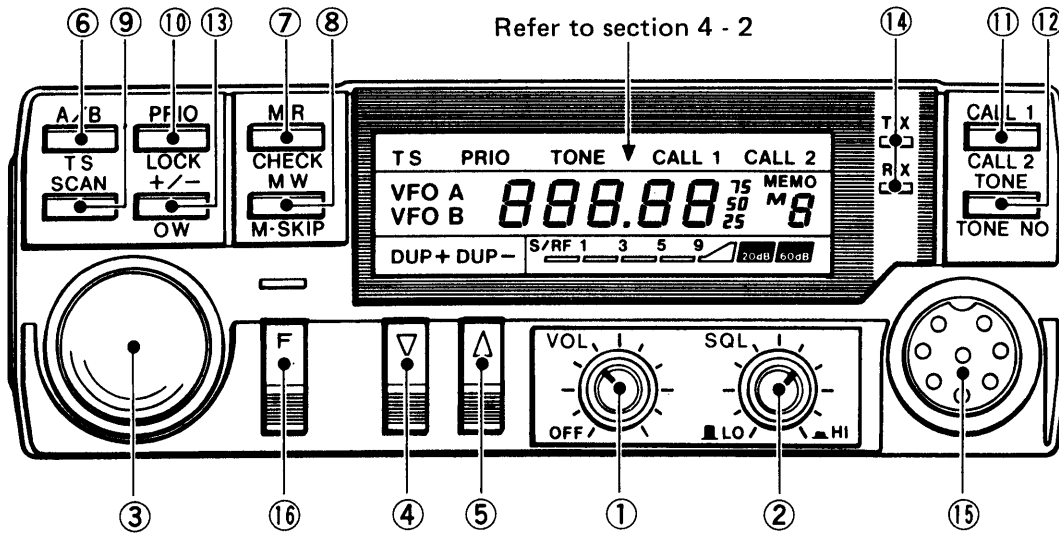

① VOLUME CONTROL and POWER SWITCH

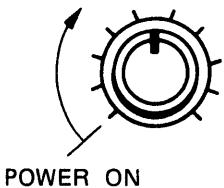

Rotate completely counterclockwise to turn power OFF. Turn clockwise beyond the "click" to turn the power ON. Rotating the control further clockwise increases the audio level. Adjust for the best audio level.

Note that turning the transceiver power OFF, does not erase any of the programmed memories due to the backup lithium battery inside the transceiver.

② SQUELCH CONTROL/ RF POWER SWITCH

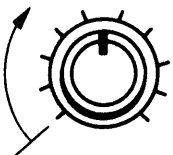

Turning this control clockwise sets the squelch threshold higher.

Sets the squelch threshold level. Rotate completely counterclockwise to turn OFF the squelch circuit. Adjust to eliminate the channel noise when no receive signals are present. Rotate clockwise to set the threshold level higher.

Also, selects the HIGH or LOW RF output power positions. Output power is 5 watts when the switch is OUT, and 25 watts when the switch is IN (normal).

③ TUNING CONTROL

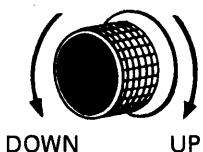

Rotate clockwise to increase the frequency in the VFO mode. Rotate counterclockwise to decrease the frequency. The frequency steps depend on the band and TS button status (explained below). When tuning upward past the upper limit of the band, the frequency automatically reverts to the lower limit. Likewise, when tuning downward beyond the lower limit, the frequency reverts to the upper limit.

Rotating this control also selects the subaudible tone when in the tone select mode (explained below).

④ & ⑤ MHz UP/DOWN

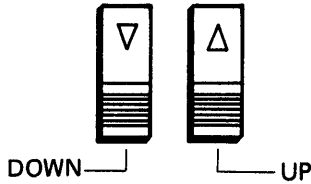

Each push increases or decreases the operating frequency in 1MHz steps. Less significant digits do not change. When tuning upward past the upper limit of the band, the frequency automatically reverts to the lower limit. Likewise, when tuning downward beyond the lower limit, the frequency reverts to the upper limit.

⑥ A/B/TUNING SPEED



Selects either VFO A or VFO B. Each push selects VFO A or VFO B alternately, and indicates the VFO status on the display.

Push the F button, and then this button. Selects the tuning frequency steps. TS appears on the display. Section 4 - 2 describes the tuning speed function and this switch status.

⑦ MEMORY READ/OFFSET CHECK



Selects the memory channel mode. The LCD displays the memory channel currently accessed.

Push the F button, and then this button. The display shows the transmit frequency when this button is held while in the Duplex mode. Thus, the repeater input frequency may be checked.

⑧ MEMORY WRITE/MEMORY SKIP



Push to write the displayed VFO frequency into the selected memory channel. The memory channel number is displayed on the right side of the LCD.

Push the F button, and then this button. The displayed memory channel will be skipped when the MEMORY SCAN mode is used.

⑨ SCAN/SELECTIVE MEMORY SCAN



Starts and stops any of the scan functions. The scan resumes from the channel or frequency which it stopped on when this button is pushed again.

Push the F button, and then this button. Scans all memory channels on a single band (144/440MHz or 430MHz).

⑩ PRIORITY/LOCK



Turns the priority function ON and OFF. Use this function to monitor a favorite or important channel; whether it is busy or free. Write the channel to be monitored into a memory channel. Select this memory channel and push the priority button. Every 5 seconds, the receive frequency switches momentarily to the priority channel when the function is activated.

Push the F button, and then this button. The VFO electronically locks at the displayed frequency and the tuning control has no effect on the receive or transmit frequency. This function is useful for rag chewing, mobile operation, nets or any time when a fixed frequency is desired. Disengage the dial lock by pushing this button again.

⑪ **CALL 1/CALL 2
FREQUENCY**



Push to instantly select MEMORY CHANNEL 8.

Push the F button, and then this button. Instantly selects MEMORY CHANNEL 9. The programmed CALL frequencies may be re-written in the same manner as other memory channels.

⑫ **TONE SWITCH/TONE
NUMBER**



IC-3200A: Push to activate the CTCSS encoder. The TONE indicator also appears on the LCD display. Push again to deactivate the encoder.

IC-3200E: Push to activate and transmit the 1750Hz tone burst.

Push the F button, and then this button. The subaudible tone number displays on the FREQUENCY DISPLAY, and the tone number may be selected by rotating the TUNING CONTROL.

⑬ **OFFSET (+/-)/OFFSET
WRITE**



Push to select SIMPLEX or DUPLEX operation.

a) The transmit frequency is above the receive frequency by the OFFSET amount when the display shows "DUP+".

b) The transmit frequency is below the receive frequency by the OFFSET amount when the display shows "DUP-".

c) No indication appears on the display when in the SIMPLEX mode.

Push the F button, and then this button. Program the OFFSET frequency into the CPU by turning the TUNING CONTROL knob.

⑭ **TRANSMIT/RECEIVE
INDICATORS**

Lights in the transmit mode.

Lights when the squelch is opened in the receive mode.

⑮ **MIC CONNECTOR**

Connect the supplied microphone to this jack. Refer to the drawing on Page 8 if you wish to use a different microphone.

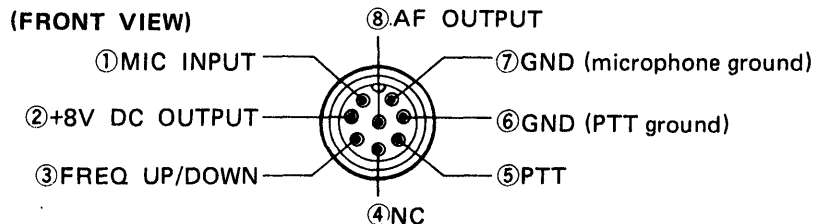

⑯ **FUNCTION (F)**

This button only works in conjunction with other buttons on the front panel.

Push the F button once, followed by a dual function button to activate the second function as marked in red. The yellow LED above the F button lights when the dual function mode is enabled. The unit automatically returns to the primary function mode after a secondary function is selected as indicated by the extinguished LED.

FUNCTION (F) LED

The yellow LED lights when the secondary functions are enabled by pushing the FUNCTION button once.

4 - 2 DISPLAY

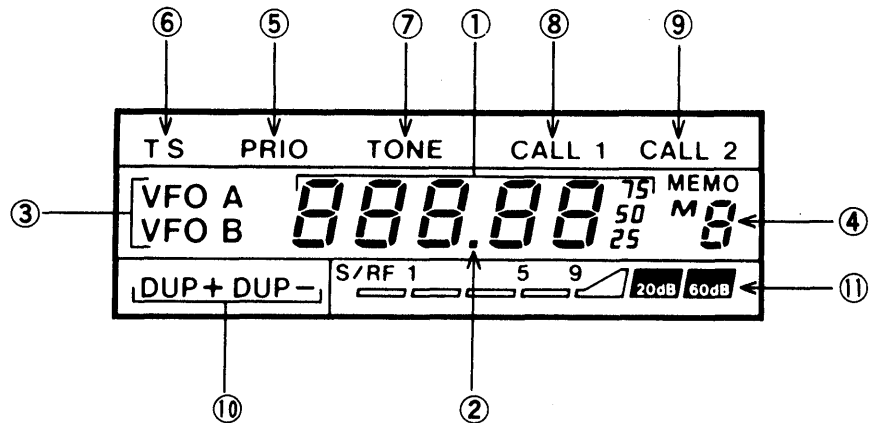

■ DISPLAY EXPLANATIONS

① FREQUENCY DISPLAY

The five large numbers represent the digits between 100MHz and 10kHz. The small 50 represents 5kHz. (The IC-3200E also has a small 25 for 2.5kHz and 75 for 7.5kHz.) The frequency indicated is the carrier frequency.

- Displays the memorized frequency on each channel when in the MEMORY CHANNEL mode.
- Displays the OFFSET FREQUENCY with three digits when the F plus OW buttons are pushed.
- Displays the TONE NUMBER with two digits when the F plus TONE buttons are pushed.

② FUNCTION INDICATOR

The decimal point between the 1MHz and 100kHz digits indicates the following:

- A blinking decimal point means the PROGRAMMED SCAN is in progress.
- No decimal point means the displayed memory channel will be skipped during scanning.

③ VFO INDICATOR

Either VFO A or VFO B displays when the transceiver is in the VFO mode. The VFO display disappears in the MEMORY CHANNEL mode and the DIAL LOCK mode.

④ MEMORY CHANNEL INDICATOR

Push the MR button to select the MEMORY CHANNEL mode and the M indicator displays. VFO A and VFO B indicators disappear. Pushing either the ▲ or ▼ button changes the MEMORY CHANNEL indication. The M indicator blinks during memory scan operations and extinguishes when in the DIAL LOCK mode.

⑤ PRIO INDICATOR

Lights when the PRIORITY FUNCTION is activated by pushing the PRIO button. Push the PRIO button again to cancel the function.

⑥ TS INDICATOR

Push the F and TS buttons to select the TUNING STEPS as follows. The TS indicator appears.

VERSION	VHF/UHF	TUNING STEPS (kHz)	
		TS OFF	TS ON
IC-3200A U.S.A.	VHF	15	5
	UHF	25	5
IC-3200A VK	VHF	25	5
	UHF	25	5
IC-3200A ASIA	VHF	15	5
	UHF	25	5
IC-3200E EUROPE	VHF	25	12.5
	UHF	25	12.5

Push the F and TS buttons again to cancel the TS indicator.

⑦ TONE INDICATOR

Push the TONE button to activate the TONE FUNCTION. The TONE indicator appears and function is ready to use. (See Page 25 for explanation of the TONE.)

⑧ CALL 1 INDICATOR
⑨ CALL 2 INDICATOR

Push the CALL 1 button to shift the transceiver to MEMORY CHANNEL 8. The CALL 1 indicator appears and the frequency of MEMORY CHANNEL 8 displays. Push the F and the CALL 2 buttons to shift the transceiver to MEMORY CHANNEL 9. The CALL 2 indicator appears and the frequency of MEMORY CHANNEL 9 displays. The MEMORY CHANNEL number does not change. Both CALL 1 and CALL 2 disappear after transferring back to the VFO mode.

⑩ DUP+/DUP-INDICATORS

Push the +/- button to activate either the +DUPLEX or -DUPLEX function. The DUP+ or DUP- indicators appear. The mode changes as shown below with each push of the +/- button.

Dup - → Dup + → no indication
(See Page 21 for more detailed information.)

⑪ S/RF LEVEL METER

Indicates the S-unit reading and the RF output with seven in-line LCD's. The numbers on the S-meter represent S1 through S9 and 60dB over S9. The RF output meter functions only as a relative indicator and does not give the output power in watts. The two functions switch automatically when changing from receive to transmit and vice versa.

4-3 REAR PANEL

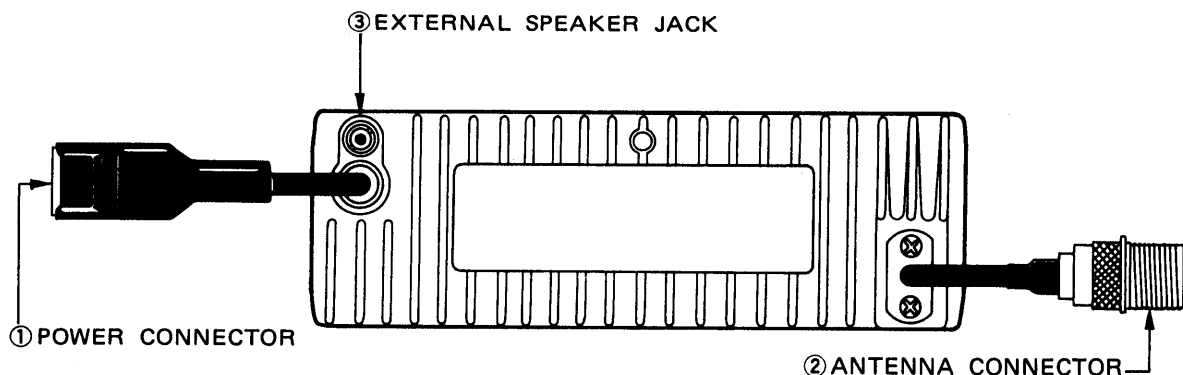

① **POWER CONNECTOR**

Connect the supplied power cord to this connector.

② **ANTENNA CONNECTOR**

Connect an antenna designed for the 144/440 (430)MHz range to this connector. Use a 50 ohm impedance antenna with a PL-259 connector installed on the feedline.

③ **EXTERNAL SPEAKER JACK**

Connect an external speaker, if one is required, to this jack. Use a 4 - 8 ohm speaker and remember, the internal speaker disconnects when the external speaker jack is used.

4-4 ADDITIONAL SWITCHES

NOTE 1: Set the switches to the desired positions before installing the unit in a vehicle. The switches cannot be accessed after completing the final installation.

Additional accessory switches are installed on the LOGIC board. This board is mounted behind the frequency display which can be seen after removing the top cover.

NOTE 2: The figure shows the factory switch settings.

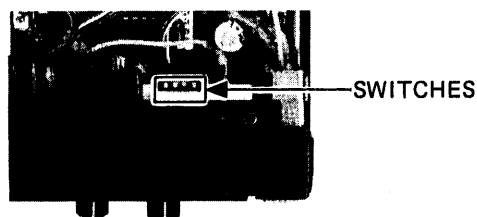
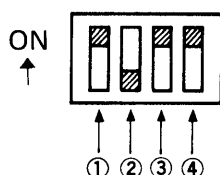

(TOP VIEW)

① **BEEP ON/OFF SWITCH**

Switches the audible beep that sounds after pushing the ▲ or ▼ button on the front panel, or the UP/DOWN buttons on the microphone. If the beep is not required, slide the switch to the OFF position.

② **SCAN STOP INTERVAL SWITCH**

Switches the scan auto-stop interval time. The scan restarts automatically after a five second delay when no signal is present, if the switch is ON. Otherwise, the scan restarts immediately following signal dropout, if the switch is OFF.

③ **MEMORY DIAL LOCK SWITCH**

Activates the electrical dial lock when in the MEMORY mode. Rotating the TUNING CONTROL alters the recalled frequency in the same manner as the VFO mode, if the switch is ON. The memory frequency locks if the switch is OFF, and the TUNING CONTROL has no effect.

④ **SCAN SPEED SWITCH**

Switches the scan speed in any scan mode. Slide the switch to the position for the desired speed:

FAST: about 0.3 second SLOW: about 1 second

SECTION 5 OPERATION

5-1 BASIC OPERATION

■ INITIAL INDICATION

Turn the power switch ON and notice that the display indicates VFO A, MEMO 0 and the frequency as shown in the table. These frequencies and tuning steps were set by the factory.

VERSION	VHF/UHF	INITIAL FREQ (MHz)	OFFSET FREQ (MHz)	TUNING STEPS (kHz)	
				TS OFF	TS ON
IC-3200A U.S.A.	VHF	146.01	0.6	15	5
	UHF	445.00	5	25	5
IC-3200A VK	VHF	145.00	0.6	25	5
	UHF	430.00	5	25	5
IC-3200A ASIA	VHF	145.00	0.6	15	5
	UHF	430.00	5	25	5
IC-3200E EUROPE	VHF	145.00	0.6	25	12.5
	UHF	435.00	7.6	25	12.5

VFO A (USA version)

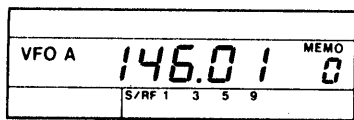

VFO B (USA version)



The following MEMORY CHANNEL frequencies are displayed the first time power is applied or after initialization is performed as explained below.

EVEN MEMORY CHANNELS (0, 2, 4, 6, 8):
VHF band initial frequency.

ODD MEMORY CHANNELS (1, 3, 5, 7, 9):
UHF band initial frequency.

At other times when the unit is turned ON, the display shows the previous VFO A information.

NOTE: To initialize the CPU, push the F button while turning the unit power switch ON. This resets the CPU, and the display indication is the same as when shipped from the factory.

■ VHF/UHF BAND CHANGING

There are two methods of changing bands.

Using VFO A/B button



Using ▲/▼ switches

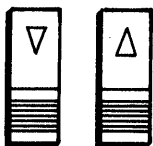

1. VFO A/B button

VFO A and VFO B may be used for the VHF and UHF bands respectively. In this case, simply push the VFO A/B button to change to the other band. However, Method 2 is preferred if no distinction by band is made between the two VFO's.

2. UP (▲) or DOWN (▼) SWITCHES

The band of operation changes when the band edge is reached while tuning. Step up or down the band by repeatedly pushing the ▲ or ▼ switches or by holding one of these switches in.

■ RECEIVING

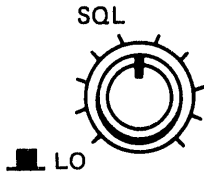
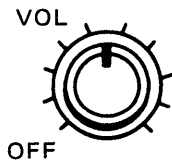

■ TRANSMITTING

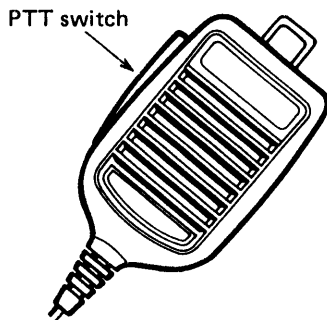

Power changing with SQUELCH CONTROL knob.

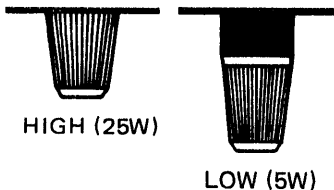

The S/R level meter indicates 60dB over S9 when transmitting with HIGH power, and S5 when using LOW power.

Connect an antenna and power cable, and then set the controls as follows.

1. Turn the SQUELCH CONTROL completely counterclockwise.
 2. Turn the VOLUME/POWER CONTROL clockwise to apply power to the transceiver. The frequency display and the RX indicator illuminate.
 3. Adjust the VOLUME CONTROL for a comfortable level.
 4. Select either the VHF or UHF band.
 5. If no signal is heard, rotate the SQUELCH CONTROL clockwise until the speaker noise just disappears. The RX indicator extinguishes.
 6. Do not adjust the SQUELCH CONTROL while receiving a signal. Use the ▲ or ▼ button to find a vacant frequency.
1. For SIMPLEX operation, push the +/– button until neither the DUP– nor the DUP+ indicators appear. For DUPLEX operation, push the +/– button until the DUP– or DUP+ indicator, as desired, appears.
 2. The VHF/UHF OFFSET frequencies are 600kHz/5.0MHz for the IC-3200A (600kHz/7.6MHz for the IC-3200E) when the transceiver is first turned ON or after initialization of the CPU. This is the standard repeater input/output frequency separation. To set non-standard offsets, refer to "RESETTING THE OFFSET FREQUENCY" on Page 22.
 3. Select either HIGH or LOW output power by pushing the RF POWER SWITCH as shown in the diagram.
 4. Push the PTT (push-to-talk) switch on the microphone to transmit. The TX INDICATOR illuminates and the S/RF indicator provides a relative output power reading at the same time.
 5. Hold the microphone about three inches from your mouth and speak in a normal voice.
 6. IC-3200E: Push the TONE CALL switch on the microphone for the required period of time to transmit a tone burst to access a repeater. Tone burst periods vary from 100 milliseconds to 2 seconds.
IC-3200A (U.S.A.) only: A 16 key dual-tone pad is provided on the microphone, and the subaudible tone encoder is installed inside the set.

5 - 2 MEMORY CHANNEL OPERATION

There are ten MEMORY CHANNELS, 0 to 9, available. The channels are programmed by the factory as shown in Section 5 - 1 "INITIAL INDICATION" at the start of this chapter.

Any frequency within the range of the transceiver may be programmed into any memory channel. However, remember the following when assigning frequencies to memory channels.

1. CH 0, CH 1: Used as band limits for the PROGRAMMED SCAN function.
2. CH 8 : Used as a call frequency for the CALL 1 function.
3. CH 9 : Used as a call frequency for the CALL 2 function.

■ MEMORY CHANNEL SELECTION

1. Push MR button.

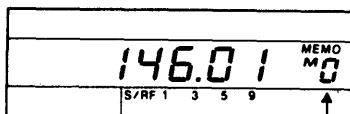

Changing channel by ▲/▼ buttons.

2. Push the ▲ or ▼ button.

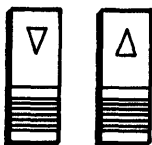

When power is first applied or on initialization (explained in Section 5 - 1), the set's display indicates the VFO A mode and MEMORY CHANNEL 0.

1. Push the MR button to switch into the MEMORY CHANNEL MODE. The display indicates the last frequency stored in MEMORY CHANNEL 0. The letter M to the left of the 0 shows that the set is in the MEMORY CHANNEL mode.
2. Push the ▲ or ▼ button to step through the different memory channels. Holding either of the buttons IN causes the set to step continuously through the channels.

(PROGRAMMING THE MEMORY CHANNELS)

Example: MEMORY WRITE 144.68MHz to MEMO CH 4.

Present display

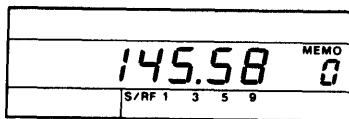

1. Push MR button.

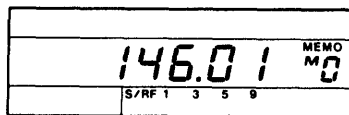

2. Push the ▲ or ▼ button to set CH4.

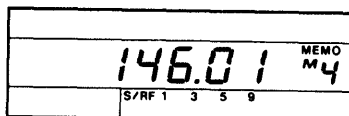

Any operating frequency, simplex/duplex mode, offset frequency and/or subaudible tone frequency (U.S.A. only) can be stored in a memory. This section describes how to write an operating frequency into memory.

Either VFO A or VFO B may be used to store an operating frequency or a frequency may be stored in a MEMORY CHANNEL while in the memory mode.

1. Push the MR button to transfer the set into the MEMORY CHANNEL mode.
2. The VFO indicator goes OFF and the letter M appears on the display. Push either the ▲ or ▼ button to set MEMO CH 4.

3. Push A/B button.

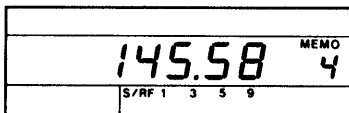

4. Set 144.68MHz.

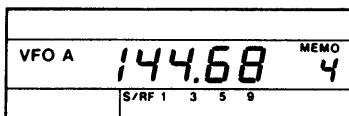

5. Push MW button.



3. Push the A/B button to return to the VFO mode.

4. Set the desired frequency, 144.68MHz, by turning the TUNING CONTROL or pushing the ▲ or ▼ button.

5. Push the MW button to memorize the frequency 144.68MHz into MEMO CH 4.

NOTE: Only the TUNING CONTROL changes the frequency when in the MEMORY CHANNEL mode. The ▲ or ▼ button only changes the MEMORY CHANNEL number therefore it is not possible to shift upward or downward in 1MHz steps.

5-3 SCANNING

■ TYPES OF SCAN

① PROGRAMMED SCAN (VFO MODE)

First, set the switches on the LOGIC board preset DIP switch to the desired positions. These settings are described in full on Page 14.

This function allows scanning between any two frequencies programmed into MEMORY CHANNELS 0 and 1. On the IC-3200A (U.S.A.) version, 5 or 15kHz steps are available on the VHF band whereas 5 or 25kHz steps are available on the UHF band. Refer to the table on Page 13 for other versions of the transceiver. MEMORY CHANNELS 0 and 1 accept any of the following combinations of frequencies:

	CHAN 0	CHAN 1
a)	VHF	VHF
b)	VHF	UHF
c)	UHF	VHF
d)	UHF	UHF

The scan always begins from the higher frequency and moves toward the lower frequency regardless which frequency is programmed into which channel.

② MEMORY SCAN (MEMO MODE)

This function allows scanning of the MEMORY CHANNELS beginning from the displayed channel and progressing toward the lower memory channels in order. When the scan reaches the lowest memory channel (CHANNEL 0), it automatically returns to the highest channel (CHANNEL 9) and continues scanning downward. The cycle continues until interrupted by the operator. Also, programmed memory channels may be skipped by using the MEMORY CHANNEL SKIP function as described on Page 20.

■ SCANNING OPERATION

① PROGRAMMED SCAN

1. Program frequencies.

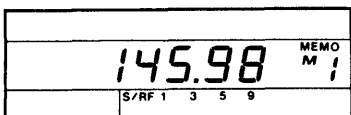
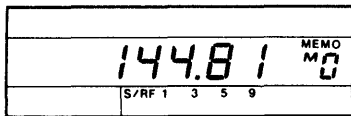

2. Push A/B button.



3. Push SCAN button.



4. SQUELCH must be closed.

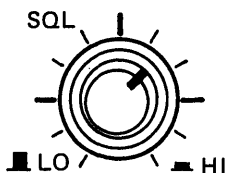

5. Push SCAN button to stop the scan.

Push SCAN button again to restart.



6. Select scan speed.

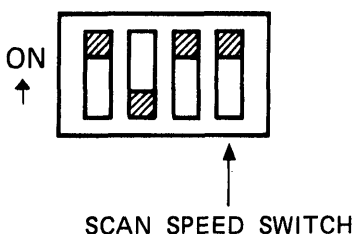

Close the squelch by rotating the SQUELCH control until the RX indicator is OFF and the audio is muted (no sound from the speaker).

1. Program the frequencies for the high and low edges of the scanning range desired into MEMORY CHANNELS 0 and 1. It is not important which frequency is programmed into which channel. How to program frequencies into memory channels is described on Page 17. In the example to the left, 144.81MHz is programmed in CHANNEL 0 and 145.98MHz is programmed in CHANNEL 1.

2. Push the A/B button to place the set in the VFO mode.

3. Push the SCAN button to start the scanning function. The scan begins at the higher frequency and moves downward toward the lower frequency in a continuous cycle. The one exception to this is when the VFO is set to a frequency between the CHANNEL 0 and 1 frequencies. In this case, the scan starts at the VFO frequency and moves downward toward the lower programmed frequency, then returns to the higher programmed frequency in a continuous cycle. The scanning frequency steps are controlled by the TUNING SPEED (TS) button described on Page 13.

4. The scan stops automatically on frequency whenever the squelch opens due to a received signal. If the SQUELCH control is not adjusted correctly, indicated by an illuminated RX indicator, before the scan begins; the scan function does not start.

5. Push the SCAN button again to stop the scan function. Push the SCAN button once more to restart the scan from the last frequency.

The time interval between signal dropout and automatic resumption of the scan may be set by the SCAN STOP INTERVAL switch on the LOGIC board under the top cover as described on Page 14.

Once the scan has automatically stopped on a frequency, the TUNING CONTROL cannot be used to change the frequency until the SCAN button is pushed to disable the scan function.

Also, note that pushing the microphone PTT switch stops the scan function.

6. The scan speed may be changed by means of the SCAN SPEED switch located on the LOGIC board under the top cover. Place the switch in either the FAST or SLOW position as described on Page 14.

■ MEMORY SCAN

1. Push MR button.



2. Push SCAN button.



3. Push SCAN button.



4. Select scan speed.

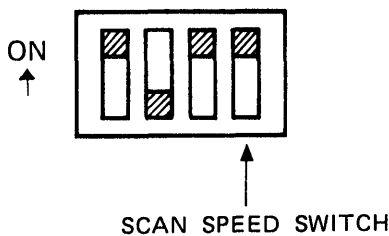

① MEMORY SKIP FUNCTION

1. Push MR button.



2. Push F button and M-SKIP.

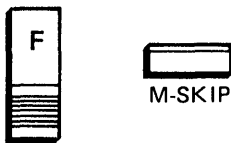

- 3.



No decimal point

1. Program ten frequencies into MEMORY CHANNELS 0 - 9.
Push the MR button to select the MEMORY CHANNEL mode.

2. Push the SCAN button. The operating frequency shifts to each of the programmed memory channels, beginning with the displayed channel number and moving downward through the channels. When the scan reaches the lowest channel number, it automatically returns to the highest channel number and continues scanning downward in a continuous cycle.

3. The scan stops automatically on a memory channel whenever the squelch opens due to a received signal. Push the SCAN button to stop and start the scan alternately. The SCAN STOP INTERVAL time can be changed by the SCAN STOP INTERVAL switch on the LOGIC board under the top cover as described on Page 14.

Pushing the microphone PTT switch also stops the scan.

4. The SCAN SPEED can be changed in the same way as the PROGRAMMED SCAN speed.

Place the switch in either FAST or SLOW position as described on Page 14.

Any channel can be skipped, if it is not desired, while using the MEMORY SCAN mode.

1. Push the MR button to place the set in the MEMORY mode. Select the channel to be skipped using the ▲ or ▼ button.

2. Push the F (FUNCTION) button, and then the MEMORY SKIP button.

3. The decimal point in the frequency display disappears to indicate that the channel will be skipped during memory scan.

4. To eliminate the MEMORY SKIP function, push the F button and the MEMORY SKIP button. The decimal appears, and the channel again becomes one of the scanned channels during MEMORY SCAN operations.

NOTE: The scan function does not operate when all ten channels are programmed for MEMORY SKIP.

② SELECTIVE MEMORY SCAN

It is possible to scan only a single band, either VHF or UHF, by using the SELECTIVE MEMORY SCAN function when in the MEMORY SCAN mode.

1. Push MR button.



2. Choose the band.
* See page 15 for band changing.
3. Push F and SCAN button.



1. Push the MR button to place the transceiver in the MEMORY CHANNEL mode.

2. Choose the band to be scanned by using the ▲ or ▼ button to select a memory channel which has either a VHF or UHF frequency programmed in it.

3. Only those memory channels which contain VHF frequencies are scanned when the scan starts from a channel programmed with a VHF frequency. Similarly, only channels which contain UHF frequencies are scanned when the scan starts from a UHF frequency.

Push the F button, and then the SCAN button to start the selective scan.

5-4 DUPLEX (REPEATER) OPERATION

■ USING THE DUPLEX MODE

① EXPLANATION

1. Push +/- button.

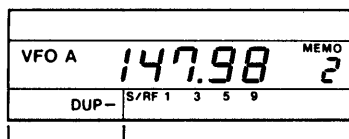

2. Push +/- button again.

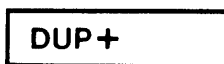

3. Push F and CHECK buttons.



The +/- button allows selection of either SIMPLEX or DUPLEX (repeater) operation. The OFFSET frequency is preset for the standard separation, that is, 600kHz on the VHF band and 5.0MHz (IC-3200E: 7.6MHz) on the UHF band. This offset is programmable as explained in "RESETTING THE OFFSET FREQUENCY" on page 22.

1. The set is in the SIMPLEX mode when the DUPLEX indicator is not visible. At this time, the transmit and receive frequencies are the same, and the operating frequency is set by either the VFO or a memory channel.

2. Push the +/- button once and the DUP- indicator in the lower left corner of the display appears which indicates the transmit frequency is 600kHz (VHF band) and 5.0MHz (UHF band) below the receive frequency (IC-3200E: 7.6MHz).

3. Push the +/- button once more and the DUP+ indicator appears which indicates the transmit frequency is 600kHz (VHF band) and 5.0MHz (UHF band) above the receive frequency (IC-3200E: 7.6MHz).

4. Push the +/- button once more to return to the SIMPLEX mode.

5. Push the F and CHECK button while in the DUPLEX mode to change the receive frequency to the transmit frequency. This function is useful to check signals at repeater inputs.

② EXAMPLE

1. Receiving frequency.

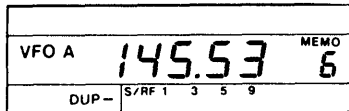

Transmitting frequency.

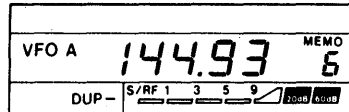

2. Push F and CHECK buttons.

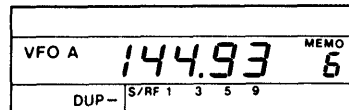

3. Receiving frequency.

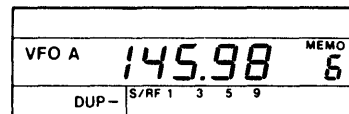

↑
600kHz difference

↓
Transmitting frequency.

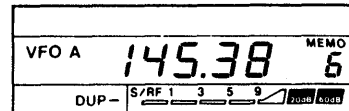

■ RESETTING THE OFFSET FREQUENCY

① EXPLANATION

1. Set the display frequency to 145.53MHz. Push the +/- button. The letters "DUP-" and the frequency "145.53" appear on the display during receive and the frequency "144.93" appears during transmit.

You are now receiving on 145.53MHz and transmitting on 144.93 MHz, therefore it is possible to access a 145.53/144.93 repeater.

2. Push the CHECK button and "144.93" appears on the display, and the receive frequency is then 144.93MHz to allow checking of a repeater input.

3. Change the receive frequency from 145.53MHz to 145.98MHz and note that the transmit frequency changes from 144.93MHz to 145.38MHz to maintain the same receive/transmit offset.

Push the +/- button to switch to the "DUP+" mode. The receive frequency remains at 145.98MHz but the transmit frequency is now 146.58MHz, or 600kHz above the receive frequency.

The transceiver works in this same manner whether in the VFO or MEMORY CHANNEL modes, or on the UHF band.

Push the F button, and then the OW (OFFSET WRITE) button to read the offset frequency in Megahertz. If no changes to the offset frequency have been made since first turning the unit ON, or after initializing the CPU; the display shows "0.60" on VHF and "5.00" (IC-3200E: "7.60") on UHF.

To change the offset frequency, rotate the TUNING CONTROL to select the new offset. The offset changes at the same rate as the TUNING STEPS indicated in the chart on Page 13. Push the OW button again to write the new offset into the memory.

NOTE: The 1MHz ▲ or ▼ button can also be used to reset the offset frequency. Each depression of the ▲ button increments the offset by 1MHz while each depression of the ▼ button decrements the offset by 1MHz.

② EXAMPLE

Setting an offset frequency of 6.2MHz on the UHF band.

1. Push A/B button.

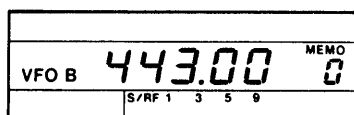

2. Push F and OW buttons.

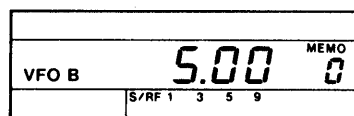

3. Set offset frequency to 6.20MHz.

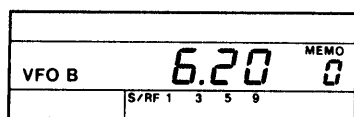

4. Push OW button.

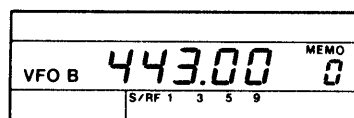

5 - 5 PRIORITY FUNCTION

■ PRIORITY OPERATION

(Example)

Monitored frequency: 144.86MHz

Operating frequency: 145.32MHz

1. Write 144.86MHz into MEMO CHAN 6.

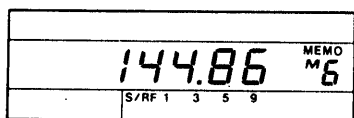

2. Push A/B and set 145.32MHz on VFO A.

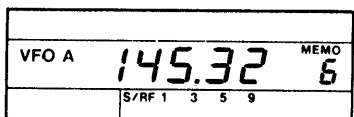

3. Push the PRIORITY button.

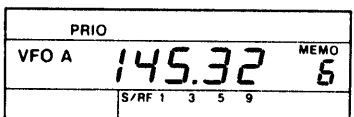

4. Display changes after 4 seconds.

1. Push the A/B button to select VFO B.

2. Push the F button, and then the OW button. The display shows "5.00" which indicates the current offset frequency is 5MHz (IC-3200E: "7.60", 7.6MHz). The set is now in the OFFSET WRITE mode.

3. Set the OFFSET FREQUENCY to 6.20MHz by turning the TUNING CONTROL or pushing the ▲ or ▼ button until the display reads "6.20".

4. Push the OW button. The offset is now 6.20MHz and the set is in the VFO mode.

NOTE: Follow the same procedure to reset the offset of a memory channel. Recall the memory channel in step 1, instead of selecting a VFO.

This function provides a way to monitor one frequency, such as a local repeater or a calling channel, while also operating on a different VFO frequency. The transceiver operates on the VFO frequency for four seconds and switches to the priority frequency stored in memory for one second, alternately.

1. Write the frequency to be monitored into a MEMORY CHANNEL. Refer to Page 17 for instructions for writing a frequency into a memory.
2. Push the A/B button and set the VFO operating frequency on VFO A.
3. Push the PRIORITY button. The PRIORITY indicator appears and the set then receives for four seconds on the VFO frequency followed by one second on the priority frequency. This cycle repeats continuously until the PRIORITY button is pushed again.
4. The priority function automatically cancels when the transmitter turns ON. The transmit frequency is the VFO frequency if in SIMPLEX mode, or the OFFSET frequency if in DUPLEX mode. After transmitting, the receiver returns to the VFO frequency.
5. Push the PRIORITY button again (or transmit, as explained in step 4) to disable the priority function. The PRIORITY indicator disappears and the operating frequency returns to the VFO A frequency.

**5 - 6 TONE ENCODER OPERATION
(IC-3200A: U.S.A. VERSION ONLY)**

The IC-3200A (U.S.A.) contains a subaudible tone encoder as standard equipment.

■ TONE SETTING

① EXPLANATION

Push the F (FUNCTION) button, and then the TONE NO. (TONE NUMBER) button. The tone number appears in place of the operating frequency. Select the desired tone number by rotating the TUNING CONTROL. Clockwise rotation increases the tone number and counterclockwise rotation decreases the tone number.

The subaudible tone frequencies are programmed by selecting the appropriate tone number as shown below in the table.

Store the selected tone number by pushing the TONE NO. button once again. The display changes to the VFO mode.

Follow the same procedure to store a tone number in a MEMORY CHANNEL.

Tone numbers do not automatically transfer between VFO A mode, VFO B mode and the MEMORY mode if the same frequency is in more than one location.

NOTE 1: Tone numbers 39-63 have audible tone frequencies, but are not specified in the table.

NOTE 2: Tone transmission is described on page 25.

Tone No.	Frequency	Tone No.	Frequency
01	67.0Hz	22	141.3Hz
02	71.9	23	146.2
03	74.4	24	151.4
04	77.0	25	156.7
05	79.9	26	162.2
06	82.5	27	167.9
07	85.4	28	173.8
08	88.5	29	179.9
09	91.5	30	186.2
10	94.8	31	192.8
11	97.4	32	203.5
12	100.0	33	210.7
13	103.5	34	218.1
14	107.2	35	225.7
15	110.9	36	233.6
16	114.8	37	241.8
17	118.8	38	250.3
18	123.0		
19	127.3		
20	131.8		
21	136.5		

— Subaudible tone frequency table —

② EXAMPLE

Storing an 88.5Hz tone frequency into MEMO CH 3.

1. Recall memory channel 3.

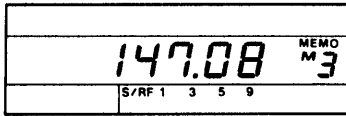

2. Push F and TONE NO. buttons.

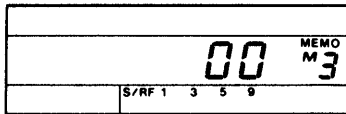

3. Select number "08".

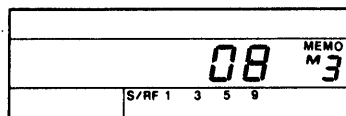

4. Push TONE NO. button.

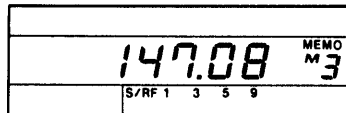

■ TONE TRANSMISSION

1. Push TONE button.

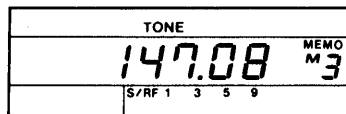

2. Verify that the "TONE" indicator is visible.

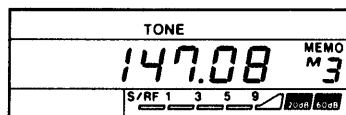

5-7 MICROPHONE UP/DOWN TUNING BUTTONS

■ FREQUENCY CONTROL

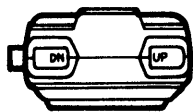

In this example, MEMORY CHANNEL 3 already has the frequency 147.08MHz stored.

See Page 17 for MEMORY CHANNEL OPERATION.

1. Use the MR and the ▲ or ▼ button to recall memory channel 3.

2. Push the F button, and then the TONE NO. button. Tone "00" is the initialized factory setting.

3. Rotate the TUNING CONTROL and select number "08" which represents 88.5Hz as shown in the subaudible tone frequency table.

4. Push the TONE NO. button again.

MEMORY CHANNEL 3 now has an operating frequency of 147.08 MHz with a subaudible tone frequency of 88.5Hz.

1. After programming the tone number as described above, push the TONE button and the TONE indicator appears on the display.

2. Push the PTT (push-to-talk) switch on the microphone to transmit and the subaudible tone is transmitted simultaneously.

NOTE: The TONE function operates equally well while using either the SIMPLEX or DUPLEX mode.

The operating frequency increments or decrements one step with each push of the UP (up) or DN (down) button, respectively, on the microphone. Holding either button down causes the transceiver to tune continuously in either the upward or downward direction in the same manner as rotating the tuning dial. The TUNING SPEED (TS) switch determines the rate of tuning.

Frequency control is possible when in the VFO mode.

■ MEMORY CHANNEL SELECTION

Each push of the UP (up) or DN (down) button on the microphone increments or decrements the memory channel one step either upward or downward. Holding either button down causes the transceiver to step continuously through the memory channels in order.

5 - 8 CPU RESET

Hold F button depressed and turn POWER SWITCH ON.

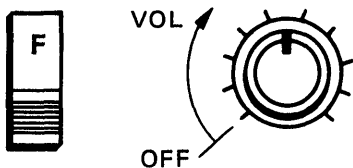

Push F button again to extinguish the function light.

This is the method for correcting a display malfunction caused, for example, by a CPU "glitch".

Turn the power switch OFF and wait for a few minutes. Turn the power switch ON. If the malfunction is still present on the display, proceed with the following steps.

1. Hold the F button depressed. Turn the POWER SWITCH ON.
2. The CPU is now reset, and all MEMORY CHANNELS and both VFO A and VFO B have all frequencies reset to their initialized values as shown on Page 15.
3. Push the F button once more to cancel the indicator light above the button.

5 - 9 CPU BACKUP BATTERY

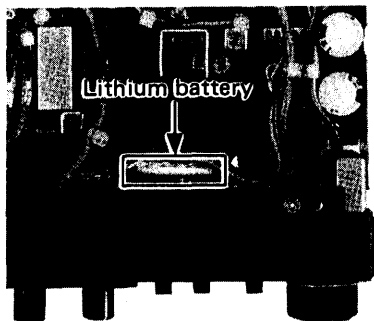

Transceiver top view

The IC-3200A/E uses an advanced, highly reliable CMOS CPU with a long life lithium battery. The purpose of the battery is to provide power to the CPU so it retains all memory information during power failures or when the unit is unplugged or turned off.

The usual life of the lithium battery is approximately five years. After five years of use, it is advisable to monitor the lithium battery carefully and replace it if there are repeated cases of display malfunction.

NOTE: Battery replacement should be done by your nearest ICOM authorized dealer or ICOM service station.

SECTION 6 INSIDE VIEWS

6-1 MAIN UNIT

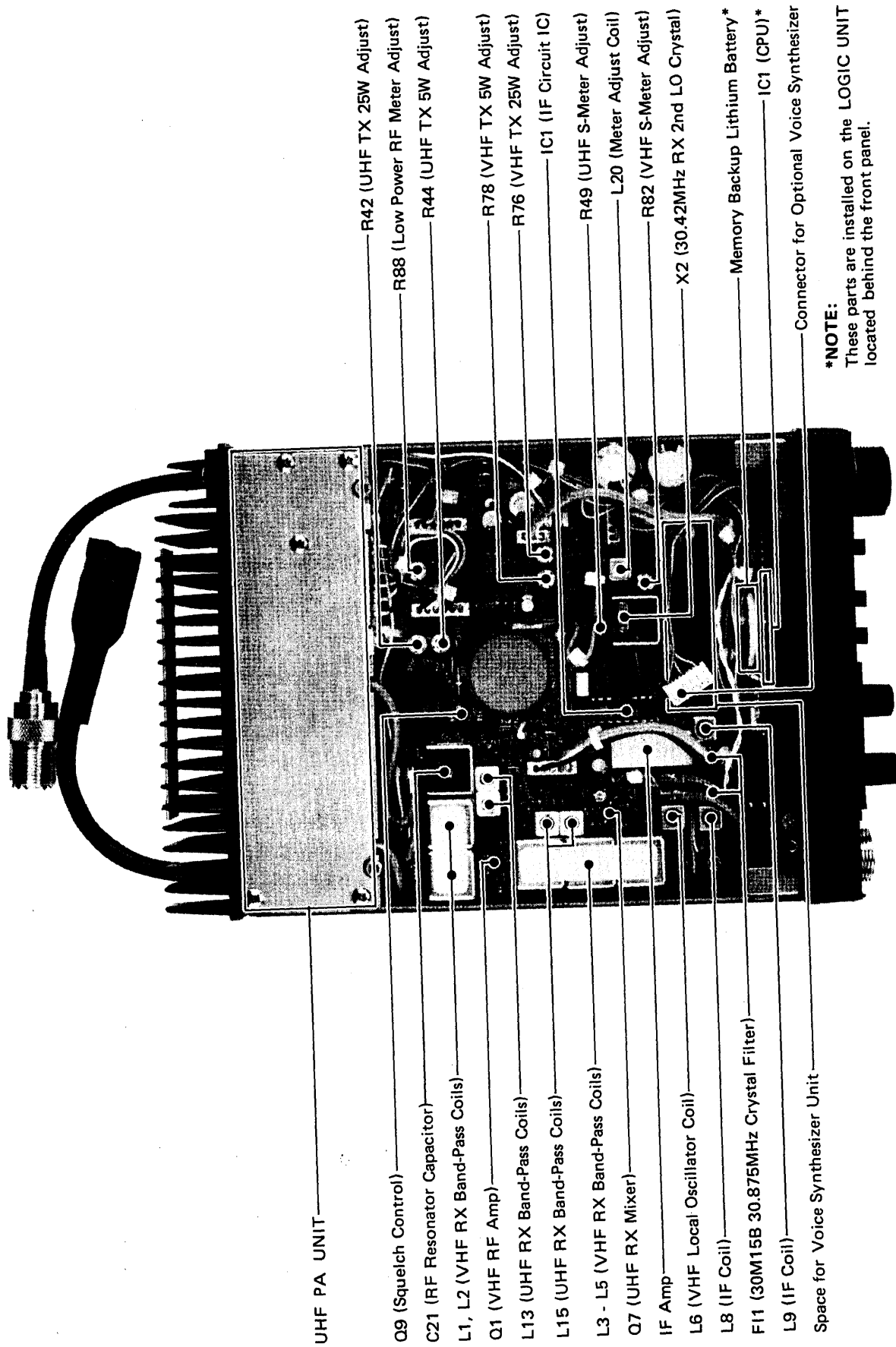

***NOTE:**
These parts are installed on the LOGIC UNIT located behind the front panel.

6-2 PLL UNIT

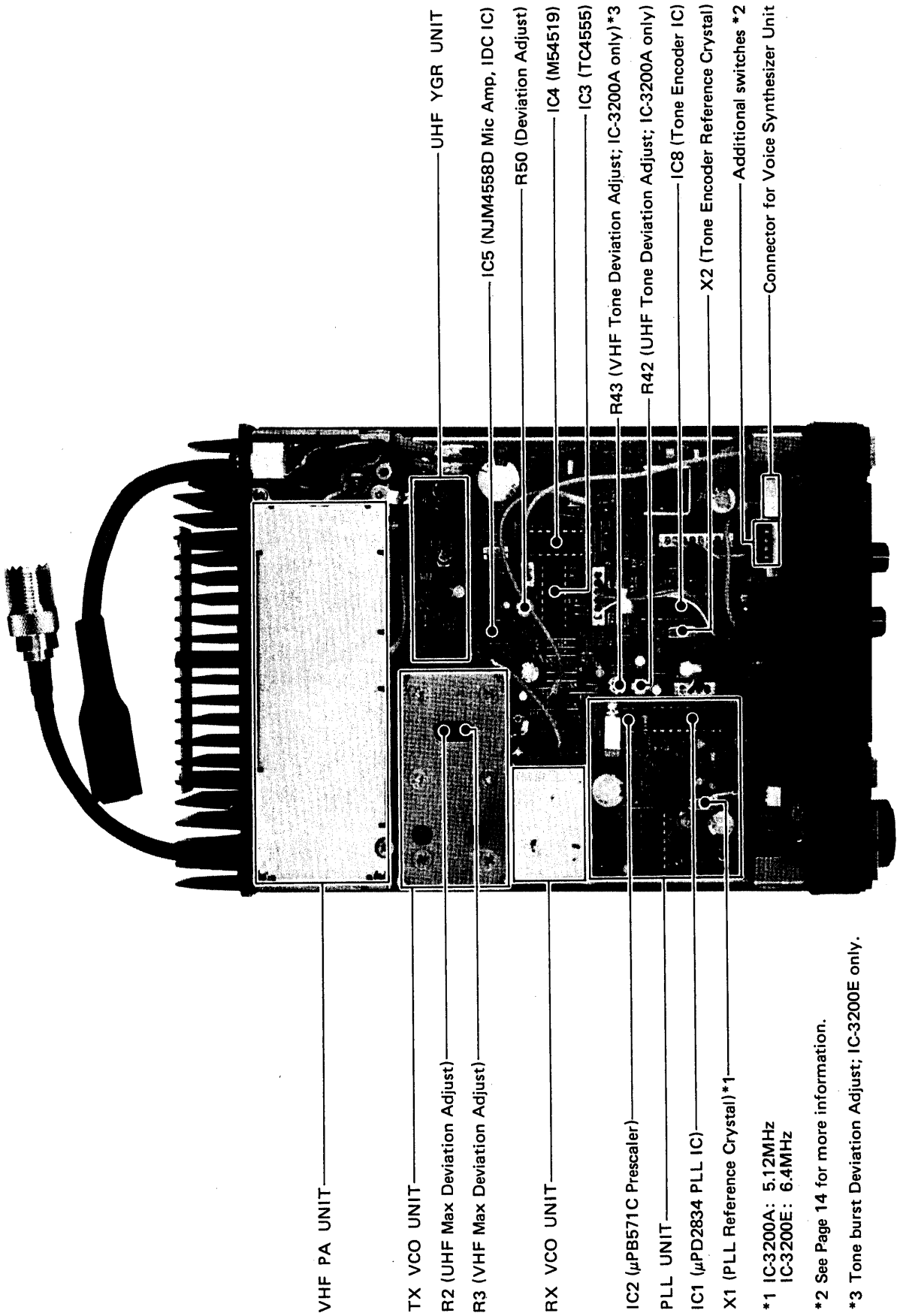

VHF PA UNIT

TX VCO UNIT

R2 (UHF Max Deviation Adjust)

R3 (VHF Max Deviation Adjust)

RX VCO UNIT

IC2 (µPB571C Prescaler)

PLL UNIT

IC1 (µPD2834 PLL IC)

X1 (PLL Reference Crystal) *1

*1 IC-3200A: 5.12MHz

IC-3200E: 6.4MHz

*2 See Page 14 for more information.

*3 Tone burst Deviation Adjust; IC-3200E only.

SECTION 7 TROUBLESHOOTING

Your IC-3200A/E was carefully tested at the factory before shipping. The chart below will help you correct any problems which are not equipment malfunctions. If you are not able to locate the problem and/or solve it through use of this chart, please contact your dealer or the nearest ICOM service center for assistance.

Problem	Possible Cause	Solution
<p>1. No power when the switch is turned ON.</p>	<p>Power cord is improperly connected.</p> <p>Power cord is connected with the polarity reversed.</p> <p>Blown fuse.</p>	<p>Carefully reconnect power cord.</p> <p>Disconnect the power cord, replace the blown fuse, then reconnect the power cord observing proper polarity.</p> <p>Check for the cause, then replace the fuse with a new one.</p>
<p>2. No sound from the speaker.</p>	<p>VOLUME CONTROL knob is completely counterclockwise, but not "clicked OFF".</p> <p>The unit is in the transmit mode, due to the PTT Switch on the microphone.</p> <p>SQUELCH CONTROL is too far clockwise.</p> <p>External speaker is in use.</p> <p>The internal speaker cable is not connected.</p>	<p>Turn the knob clockwise to a suitable level.</p> <p>Put the unit in the receive mode.</p> <p>Turn the SQUELCH CONTROL counterclockwise until noise can be heard and reset it just above the threshold.</p> <p>Check if the external speaker plug is inserted properly or if the external speaker cable is cut.</p> <p>Connect the speaker cable.</p>
<p>3. Sensitivity is low and only strong signals are audible.</p>	<p>The antenna feedline is cut or shorted.</p>	<p>Check the feedline and correct any improper condition.</p>
<p>4. No or low RF output.</p>	<p>PTT switch is not functioning due to bad connection of the MIC connector.</p> <p>The antenna feedline is cut or shorted.</p>	<p>Check the connection of the MIC connector and correct any problems.</p> <p>Check the antenna feedline and correct any problems.</p>
<p>5. No modulation.</p>	<p>Bad connection at the MIC connector.</p> <p>The MIC cable is cut.</p>	<p>Check the connections at the MIC connector and correct any problems.</p> <p>Repair the disconnected or cut wires.</p>

Problem	Possible Cause	Solution
<p>6. The receive mode functions properly and your signals are transmitted, but you are unable to make a contact with another station.</p>	<p>The set is in DUPLEX mode. (when SIMPLEX is desired)</p> <p>The set is in SIMPLEX mode. (when DUPLEX is desired)</p> <p>Improper frequency split or input/output repeater frequencies reversed.</p>	<p>Push the +/- button to select SIMPLEX mode.</p> <p>Push the +/- button to select either DUPLEX+ or DUPLEX- mode.</p> <p>Set the proper frequency split, or push the +/- button to select either DUPLEX+ or DUPLEX- mode according to the repeater input/output frequencies.</p>
<p>7. The memory scan mode does not function when the SCAN button is pushed.</p>	<p>The set is not in the MEMORY CHANNEL mode.</p> <p>All memory channels are programmed with the MEMORY SKIP function.</p> <p>SQUELCH is open. (RX light is ON)</p>	<p>Push the MR button.</p> <p>Delete some of the MEMORY SKIP programming from the memory channels by pushing the F and M-SKIP keys.</p> <p>Rotate SQUELCH CONTROL clockwise until RX light just extinguishes.</p>
<p>8. The programmed scan mode does not function when the SCAN button is pushed.</p>	<p>The set is not in the VFO mode.</p> <p>SQUELCH is open. (RX light is ON)</p>	<p>Push the A/B button to select the VFO mode.</p> <p>Rotate SQUELCH CONTROL clockwise until RX light just extinguishes.</p>

SECTION 8 BLOCK DIAGRAM

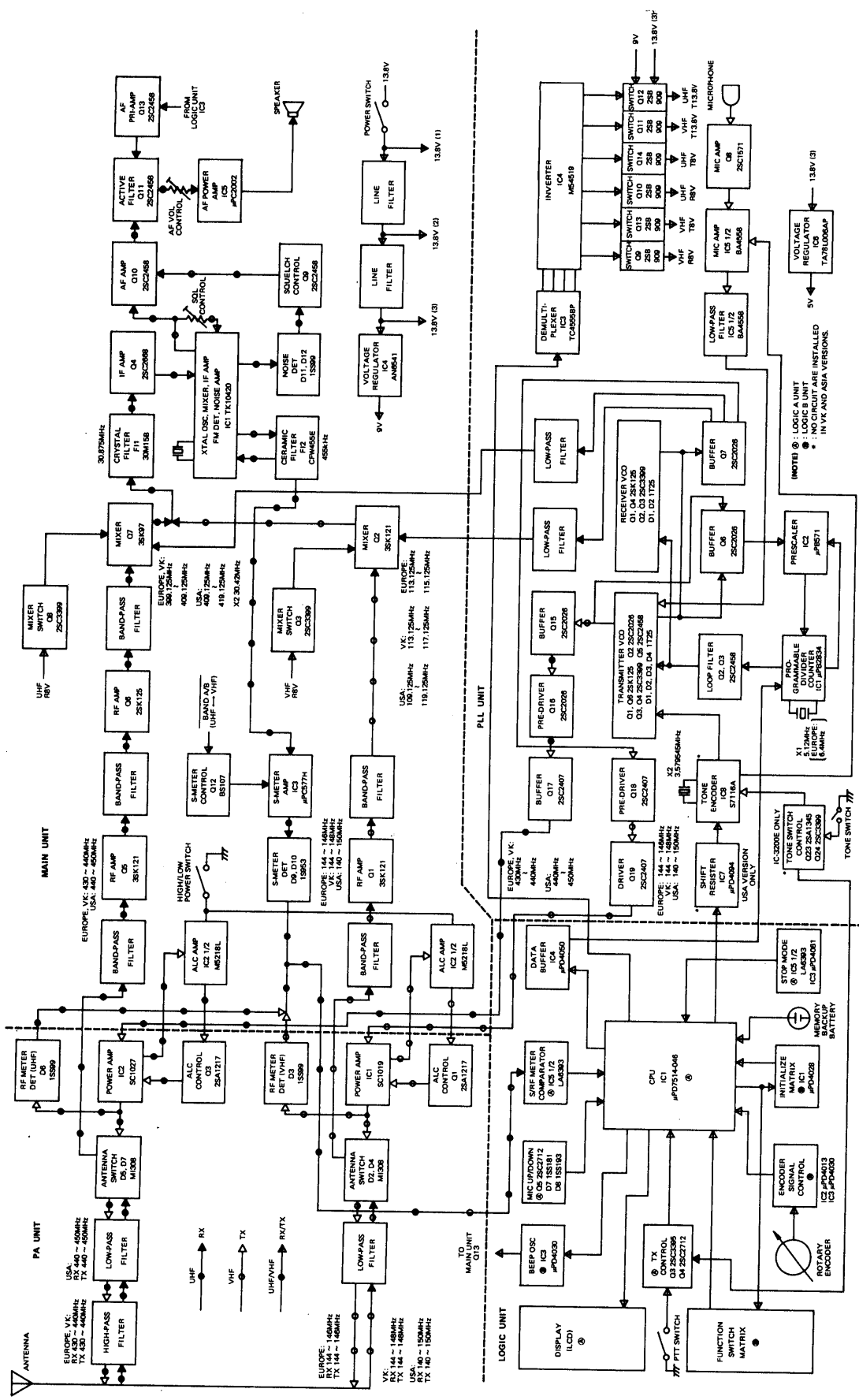

NOTE

The IC-3200 series includes the IC-3200A model currently available in the U.S.A., VK or ASIA versions and the IC-3200E model available in the Europe version.

The model number is specified on both the front panel and the serial number plate on the rear panel.

IC-3200A or IC-3200E

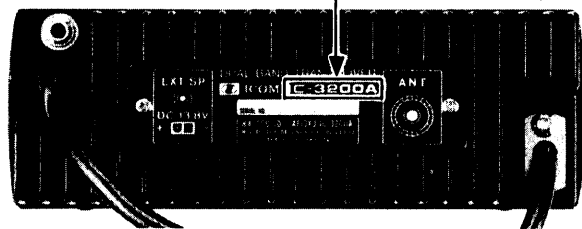

■ OPTIONS

The ICOM IC-3200A/E is specially designed for easy use in mobile environments, yet it has the sophistication necessary for your base station. We recommend the following options to complement your new transceiver.

**BASE STATION AC POWER SUPPLY
(13.8 volts, 8 amperes max.)**

PS-45

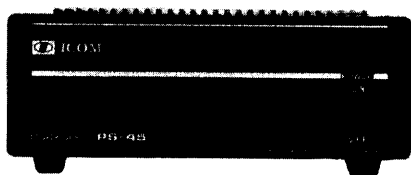

NOTE: The OPC-102 interface cable to connect the PS-45 to the IC-3200A/E must be purchased separately.

**MOBILE MICROPHONE AND
PTT SWITCH BOX**

HS-15

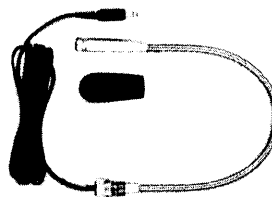

HS-15SB

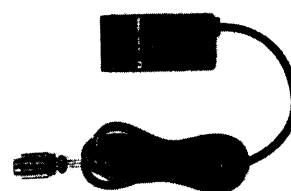

**DESK ELECTRET
CONDENSER MICROPHONE**

SM-8

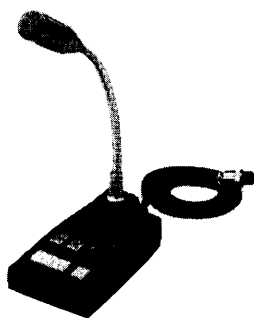

EXTERNAL SPEAKER

SP-10

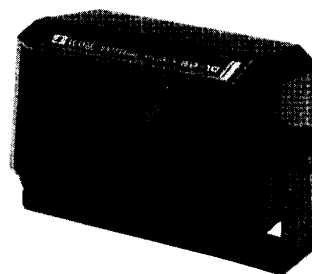

VOICE SYNTHESIZER UNIT

UT-23

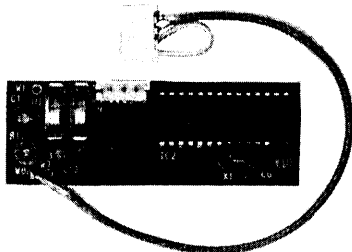

ANTENNA

Dual Band (144/430 or 440MHz) antennas for mobile or base station use are readily available. Operation on both the VHF and UHF bands is possible with no other antennas required if a dual band antenna is installed at your station.



ICOM INCORPORATED
1-6-19, KAMI KURATSUKURI, HIRANO-KU,
OSAKA JAPAN

A-0638
Printed in Japan