



INSTRUCTION MANUAL

---

VHF FM REPEATER

**IC-FR5000**

UHF FM REPEATER

**IC-FR6000**

**IC-FR6000-L**

---

---

---

---

---



Thank you for choosing this Icom product. This product is designed and built with Icom's state of the art technology and craftsmanship. With proper care, this product should provide you with years of trouble-free operation.

## ◆ FEATURES

- **Up to 2 channels of operation**  
You can install a channel extension module (optional UR-FR5000/UR-FR6000) into a repeater. 2 channels can be operated on the same repeater when a channel extension module is installed.
- **Built-in 5-Tone, DTMF encoder & decoder**  
Multiple signaling systems are built-in as standard. These systems are fully compatible with Icom F-series radios.
- **DTMF remote control capability**  
You can control the repeater from a remote location over the air or over a phone line with DTMF.
- **D-Sub 25 pin ACC port equipped**  
You can use optional equipment through the D-sub 25 pin ACC port on the repeater's rear panel.
- **Online control and Digital Trunking operation**  
Online control and digital trunking operation are available when the optional UC-FR5000 TRUNKING/NETWORK CONTROLLER is installed in the repeater.
- **Other features**
  - Wide frequency coverage
    - <VHF>  
IC-FR5000 : 136 to 174 MHz
    - <UHF>  
IC-FR6000/IC-FR6000-L  
: 350 to 400 MHz,  
400 to 470 MHz,  
450 to 512 MHz,  
450 to 520 MHz
  - PC programmable
  - 19 inch rack mount
  - Optional Voice Scrambler Unit (UT-109R/UT-110R) for base operating mode

Icom is not responsible for the destruction or damage to the Icom transceiver, if the malfunction is because of:

- Force majeure, including, but not limited to, fires, earthquakes, storms, floods, lightning, other natural disasters, disturbances, riots, war, or radioactive contamination.
- The use of Icom transceivers with any equipment that is not manufactured or approved by Icom.

## IMPORTANT

**READ THIS INSTRUCTION MANUAL CAREFULLY** before attempting to operate the repeater.

**SAVE THIS INSTRUCTION MANUAL**— This manual contains important safety and operating instructions for the IC-FR5000/IC-FR6000/IC-FR6000-L VHF/UHF FM REPEATERS.

## EXPLICIT DEFINITIONS

WORD	DEFINITION
⚠ <b>WARNING!</b>	Personal injury, fire hazard or electric shock may occur.
<b>CAUTION</b>	Equipment damage may occur.
<b>NOTE</b>	If disregarded, inconvenience only. No risk of personal injury, fire or electric shock.

## SUPPLIED ACCESSORIES

The following accessories are supplied.

Handles

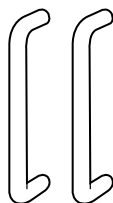

For handles attachment

Spacers



Screws



DC power cable (OPC-1784)

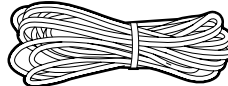

DC power cable (CAB-1149)\*2

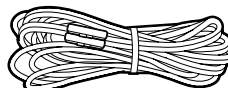

Function name stickers\*1



\*1 Used for labelling the programmable function keys according to their assigned functions.

\*2 Not supplied, depending on the repeater version.

Icom, Icom Inc. and the Icom logo are registered trademarks of Icom Incorporated (Japan) in Japan, the United States, the United Kingdom, Germany, France, Spain, Russia, Australia, New Zealand, and/or other countries. All other products or brands are registered trademarks or trademarks of their respective holders.

---

## PRECAUTIONS

---

⚠ **WARNING HIGH VOLTAGE! NEVER** touch an antenna or internal antenna connector while transmitting. This could cause an electrical shock or RF burn.

⚠ **WARNING HIGH VOLTAGE! NEVER** install the antenna at any place that person easily touch the antenna while transmitting. This could cause an electrical shock or RF burn.

⚠ **WARNING! NEVER** apply AC power to the DC power receptacle on the repeater rear panel. This could cause a fire or damage the repeater.

⚠ **WARNING! NEVER** apply more than 16 V DC to the DC power receptacle on the repeater rear panel. This could cause a fire or damage the repeater.

⚠ **WARNING! NEVER** reverse the DC power cable polarity. This could cause a fire or damage the repeater.

⚠ **WARNING! NEVER** let metal, wire or other objects contact the inside of the repeater, or make incorrect contact with connectors on the rear panel. This could cause an electric shock or damage the repeater.

**CAUTION: DO NOT** place or leave the repeater in areas with temperatures below  $-30^{\circ}\text{C}$  ( $-22^{\circ}\text{F}$ ) or above  $+60^{\circ}\text{C}$  ( $+140^{\circ}\text{F}$ ). Be aware that temperatures can exceed  $80^{\circ}\text{C}$  ( $+176^{\circ}\text{F}$ ), resulting in permanent damage to the repeater if left there for extended periods.

**CAUTION: DO NOT** place or leave the repeater in excessively dusty environments. This could damage the transceiver.

**CAUTION: DO NOT** put anything on top of the repeater. This will obstruct heat dissipation.

**CAUTION: DO NOT** set the repeater's RF output power to more than your external linear amplifier's maximum input level, if you use one. Otherwise, a high input could damage the linear amplifier.

**CAUTION: DO NOT** use non-Icom microphones. Other manufacturer's microphones may have different pin assignments, and could damage the connector and/or the transceiver.

**BE CAREFUL!** The heatsink will become hot when continuously operating the repeater for long periods of time.

**NEVER** expose the repeater to rain, snow or any liquids.

**NEVER** leave the transceiver in an insecure place to avoid use by unauthorized persons.

### **For U.S.A. only**

**CAUTION:** Changes or modifications to this repeater, not expressly approved by Icom Inc., could void your authority to operate this repeater under FCC regulations.

---

## TABLE OF CONTENTS

---

IMPORTANT.....	i
EXPLICIT DEFINITIONS.....	i
SUPPLIED ACCESSORIES.....	i
PRECAUTIONS.....	ii
SAFETY TRAINING INFORMATION .....	iii

<b>1 PANEL DESCRIPTION .....</b>	<b>1-3</b>
■ Front panel .....	1
◇ Function display .....	2
■ Rear panel.....	2
◇ Accessory connector .....	3
<b>2 INSTALLATION AND CONNECTIONS ....</b>	<b>4-6</b>
■ Unpacking .....	4
■ Selecting a location .....	4
■ Antenna connection .....	4
■ Front panel connection.....	5
■ Rear panel connection .....	5
■ Power supply connection .....	6
■ Mounting the repeater .....	6
◇ Using the supplied handles.....	6
■ Fuse replacement .....	6
◇ Line fuse replacement.....	6
<b>3 OPERATION .....</b>	<b>7</b>
■ Receiving and transmitting.....	7
◇ Repeater operation .....	7
◇ Base station operation .....	7
<b>4 MAINTENANCE.....</b>	<b>8</b>
■ Troubleshooting .....	8
<b>5 OPTIONS .....</b>	<b>9</b>
<b>6 INFORMATION .....</b>	<b>10</b>



---

## SAFETY TRAINING INFORMATION

---



Your Icom radio generates RF electromagnetic energy during transmit mode. This radio is designed for and classified as “Occupational Use Only,” meaning it must be used only during the course of employment by individuals aware of the hazards, and the ways to minimize such hazards.

**This radio is NOT intended for use by the “General Population” in an uncontrolled environment.**

- For compliance with FCC and IC RF Exposure Requirements, the transmitter antenna installation shall comply with the following three conditions:
  1. The transmitter antenna gain shall not exceed 0 dBi.
  2. IC-FR5000:  
Transmit only when people are at least the recommended minimum distance of 141 centimeters away from the properly installed antenna. This separation distance will ensure that there is sufficient distance from a properly installed externally-mounted antenna to satisfy the RF exposure requirements in the applicable RF exposure compliance standards.
  2. IC-FR6000/IC-FR6000-L:  
Transmit only when people are at least the recommended minimum distance of 122 centimeters away from the properly installed antenna. This separation distance will ensure that there is sufficient distance from a properly installed externally-mounted antenna to satisfy the RF exposure requirements in the applicable RF exposure compliance standards.



To ensure that your exposure to RF electromagnetic energy is within the FCC and IC allowable limits for occupational use, always adhere to the following guidelines:

- **DO NOT** operate the radio without a proper antenna attached, as this may damage the radio and may also cause you to exceed FCC and IC RF exposure limits. A proper antenna is the antenna supplied with this radio by the manufacturer or an antenna specifically authorized by the manufacturer for use with this radio.
- **DO NOT** transmit for more than 50% of total radio use time (“50% duty cycle”). Transmitting more than 50% of the time can cause FCC and IC RF exposure compliance requirements to be exceeded. The radio is transmitting when the “TX indicator” lights red. You can cause the radio to transmit by pressing the “PTT” switch.

### **Electromagnetic Interference/Compatibility**

During transmissions, your Icom radio generates RF energy that can possibly cause interference with other devices or systems. To avoid such interference, turn off the radio in areas where signs are posted to do so. **DO NOT** operate the transmitter in areas that are sensitive to electromagnetic radiation such as hospitals, aircraft, and blasting sites.



Votre radio Icom produit une énergie électromagnétique de radiofréquences (RF), en mode de transmission. Cette radio est conçue pour un «usage professionnel seulement» et classée comme tel, ce qui signifie qu'elle doit être utilisée uniquement dans le cadre d'un travail par des personnes conscientes des dangers et des mesures visant à minimiser ces dangers. Elle **N'EST PAS** conçue pour une «utilisation grand public», dans un environnement non contrôlé.

- Afin de satisfaire aux exigences de la FCC et d'IC en matière d'exposition aux RF, il est nécessaire que l'antenne soit installée conformément aux trois conditions suivantes:
  1. Le gain de l'antenne du radio émetteur ne doit pas dépasser 0 dBi.
  2. IC-FR5000:  
Transmettre que lorsque les gens sont au moins la distance minimale recommandée de 141 centimètres de l'antenne est correctement installé. Cette distance de sécurité assurera que les personnes soient placées suffisamment loin d'une antenne correctement fixée à l'extérieur pour satisfaire aux exigences en matière d'exposition aux RF, en vertu des normes de conformité applicables.
  2. IC-FR6000/IC-FR6000-L:  
Transmettre que lorsque les gens sont au moins la distance minimale recommandée de 122 centimètres de l'antenne est correctement installé. Cette distance de sécurité assurera que les personnes soient placées suffisamment loin d'une antenne correctement fixée à l'extérieur pour satisfaire aux exigences en matière d'exposition aux RF, en vertu des normes de conformité applicables.



Afin de vous assurer que votre exposition à une énergie électromagnétique de RF se situe dans les limites permises par la FCC et d'IC pour une utilisation grand public, veuillez en tout temps respecter les directives suivantes:

- **NE PAS** faire fonctionner la radio sans qu'une antenne appropriée y soit fixée, car ceci risque d'endommager la radio et causer une exposition supérieure aux limites établies par la FCC et d'IC. L'antenne appropriée est celle qui est fournie avec cette radio par le fabricant ou une antenne spécialement autorisée par le fabricant pour être utilisée avec cette radio.
- **NE PAS** émettre pendant plus de 50% du temps total d'utilisation de l'appareil («50% du facteur d'utilisation»). Émettre pendant plus de 50% du temps total d'utilisation peut causer une exposition aux RF supérieure aux limites établies par la FCC et d'IC. Lorsque le voyant DEL rouge s'allume, cette radio est en train d'émettre. La radio émettra si vous appuyez sur le bouton du microphone.

#### **Interférence électromagnétique et compatibilité**

En mode de transmission, votre radio Icom produit de l'énergie de RF qui peut provoquer des interférences avec d'autres appareils ou systèmes. Pour éviter de telles interférences, mettez la radio hors tension dans les secteurs où une signalisation l'exige. **NE PAS** faire fonctionner l'émetteur dans des secteurs sensibles au rayonnement électromagnétique tels que les hôpitaux, les aéronefs et les sites de dynamitage.

## Front panel

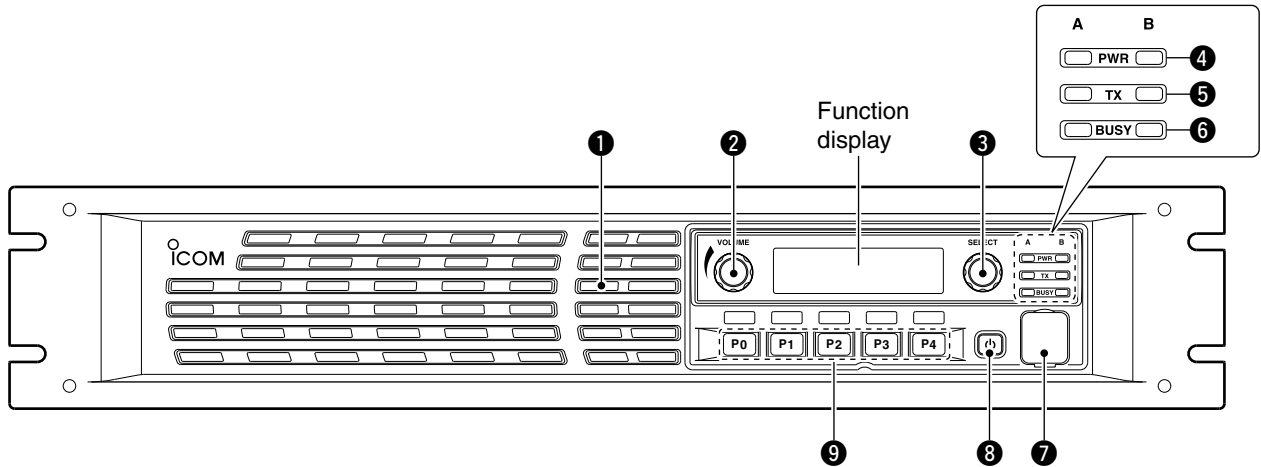

### 1 INTERNAL SPEAKER

Outputs the received audio.

### 2 VOLUME CONTROL [VOLUME] (p. 7)

Adjusts the audio output level.

### 3 SELECTOR DIAL [SELECT]

Rotate to adjust the squelch threshold level, select the operating channel. (Depending on the presetting.)

### 4 POWER INDICATOR [POWER]

➔ Lights green at 'A' module's indicator while the repeater power is turned ON.

#### **When a channel extension module is installed:**

- ➔ Lights green at the selected module indicator ('A' or 'B') while the repeater power is turned ON.
- ➔ Lights orange at the un-selected module indicator ('A' or 'B') while the repeater power is turned ON.

### 5 TRANSMIT INDICATOR [TX]

Lights red while transmitting.

### 6 BUSY INDICATOR [BUSY]

Lights green while receiving a signal or when the noise squelch is open.

#### **About [PWR], [TX] and [BUSY] indicators:**

'A' and 'B' modules indicators are usable for these indications. 'A' module's indicator corresponds to the original module, and 'B' module's indicator corresponds to an extended module.

### 7 MICROPHONE CONNECTOR [MIC]

This 8-pin modular jack accepts an optional microphone.

**KEEP** the [MIC] connector cover attached to the repeater when an optional microphone is not used.

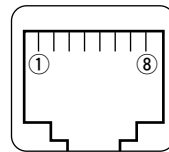

(Front panel view)

- ① +8 V DC output (Max. 15 mA)
- ② Output port for PC programming
- ③ NC
- ④ M PTT (Input port for TX control)
- ⑤ Microphone ground
- ⑥ Microphone input
- ⑦ Ground
- ⑧ Input port for PC programming

### 8 POWER SWITCH [POWER]

- ➔ Push to turn ON the repeater power.
- ➔ Hold down for 3 seconds to turn OFF the repeater power.

#### **When a channel extension module is installed:**

- ➔ While the repeater power is turned ON, push to select the desired module to operate the repeater as the base station.
  - The power indicator of the selected module unit lights green.

### 9 DEALER-PROGRAMMABLE KEYS

Desired functions can be independently preset by your dealer.

Ask your dealer for details.

- Because these keys are programmable, the functions are unique to each unit.

◇ **Function display**

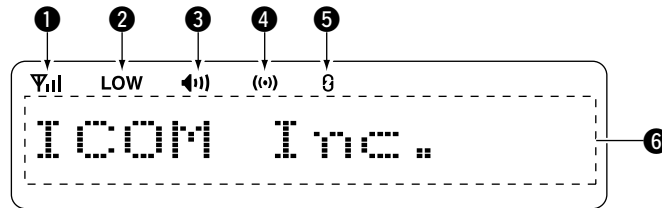

**1 SIGNAL STRENGTH INDICATOR**

Indicates relative signal strength level.

**2 LOW POWER INDICATOR**

Appears when low output power is selected.

**3 AUDIBLE INDICATOR**

Appears when the channel is in the 'audible' (unmute) mode.

**4 COMPANDER INDICATOR**

Appears when the compander function is activated.

**5 SCRAMBLER/ENCRYPTION INDICATOR**

Appears when the voice scrambler/encryption function is activated.

**6 ALPHANUMERIC DISPLAY**

Shows a variety of text or code information.

■ **Rear panel**

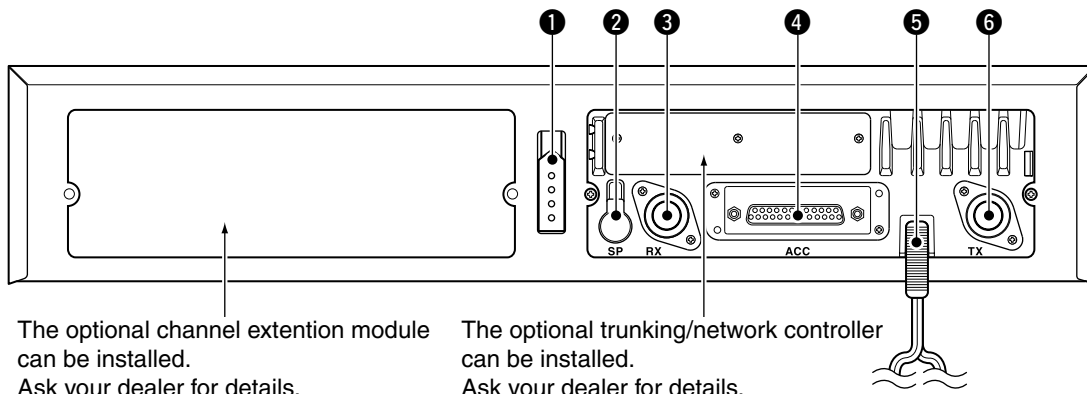

The optional channel extension module can be installed. Ask your dealer for details.

The optional trunking/network controller can be installed. Ask your dealer for details.

The repeater rear panel may be different, depending on the repeater's version.

**1 DC POWER CONNECTOR** (For cooling fans)

Connects to the supplied CAB-1149 DC power cable from this connector to an external 13.6 V DC power source to activate the cooling fans. (Depending on the repeater version) See page 5 for the connection details.

**2 EXTERNAL SPEAKER CONNECTOR [SP]**

Connects to the optional SP-35.

**3 RECEIVE ANTENNA CONNECTOR [RX]**

Connects to a receive antenna (impedance: 50 Ω).

**4 ACCESSORY CONNECTOR [ACC]**

Connects to the accessory connector.  
• See p. 3 for accessory connector information.

**5 DC POWER RECEPTACLE**

Connects to the supplied OPC-1784 DC power cable from an external 13.6 V DC power source. See page 5 for the connection details.

**6 TRANSMIT ANTENNA CONNECTOR [TX]**

Connects to a transmit antenna (impedance: 50 Ω).

# 1 PANEL DESCRIPTION

## ◇ Accessory connector

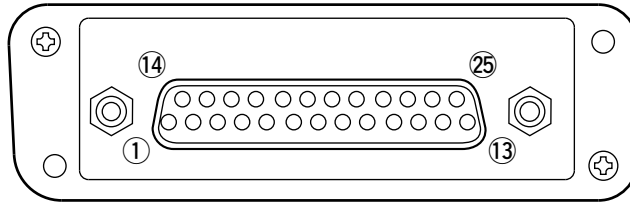

Pin No.	Pin Name	Description	Specification
1	NC	No connection	—
2	TXD	Output terminal for serial communication data.	—
3	RXD	Input terminal for serial communication data.	—
4	RTS	Output terminal for request-to-send data.	—
5	CTS	Input terminal for clear-to-send data.	—
6	NC	No connection	—
7	GND	Serial/digital signal ground	—
8	MOD IN	Modulator input from an external terminal unit.	Input level: 300 mV rms
9	DISC OUT	Output terminal for AF signals from the AF detector circuit. Output level is fixed, regardless of the [AF] control setting.	Output level: 300 mV rms
10	EXT. D/A	The desired function can be assigned.* (Default: Null)	—
11	VCC	13.6 V DC output	Output current: Less than 1 A
12	EXT. A/D	Customize A/D input (Not used)	—
13	NC	No connection	—
14	GND	Ground	—
15	EXT./O 15	The desired function can be assigned.* (Default: Null)	+5 V pull up, Active=L
16	EXT./O 16	The desired function can be assigned.* (Default: P0 Monitor Output)	+5 V pull up, Active=L
17	EXT./O 17	The desired function can be assigned.* (Default: Busy Output)	+5 V pull up, Active=L
18	EXT./O 18	The desired function can be assigned.* (Default: Null)	+5 V pull up, Active=L
19	EXT./O 19	The desired function can be assigned.* (Default: EPTT Input)	+5 V pull up, Active=L
20	DATA IN	Input terminal for data.	—
21	EXT./O 21	The desired function can be assigned.* (Default: Analog Audible Output)	+5 V pull up, Active=L
22	AF OUT	The AF detector Output.	—
23	EXT./O 23	The desired function can be assigned.* (Default: Mic Mute Output)	+5 V pull up, Active=L
24	EXT./O 24	The desired function can be assigned.* (Default: Null)	+5 V pull up, Active=L
25	EXT./O 25	The desired function can be assigned.* (Default: Mic Hanger Output)	+5 V pull up, Active=L

\* The desired function can be assigned using the optional CS-FR5000 CLONING SOFTWARE. Ask your dealer for details.



## ■ Unpacking

After unpacking, immediately report any damage to the delivering carrier or dealer. Keep the shipping cartons.

For a description and a diagram of accessory equipment included with the repeater, see 'SUPPLIED ACCESSORIES' on page i of this manual.

## ■ Selecting a location

Select a location for the repeater that allows adequate air circulation, free from extreme heat, cold, or vibrations, and away from TV sets, TV antenna elements, radios and other electromagnetic sources.

## ■ Antenna connection

For radio communications, the antenna is a critical component, along with output power and sensitivity. Select antenna(s), such as a well-matched 50 Ω antenna, and feedline. 1.5:1 or better of Voltage Standing Wave Ratio (VSWR) is recommended for the desired band. Of course, the transmission line should be a coaxial cable.

**CAUTION:** DO NOT install the repeater without a lightning arrestor to help protect the repeater from lightning.

**NOTE:** There are many publications that describe proper antennas and their installation. Check with your local dealer for more information and recommendations.

1  
2

### TYPE-N CONNECTOR INSTALLATION EXAMPLE

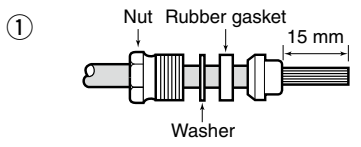

Slide the nut, flat washer, rubber gasket and clamp over the coaxial cable, then cut the end of the cable evenly.

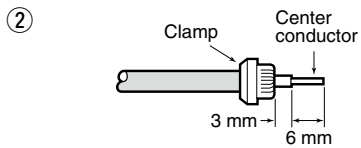

Strip the cable and fold the braid back over the clamp.

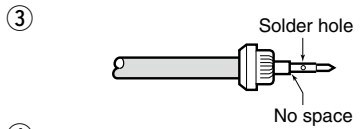

Soft solder the center conductor. Install the center conductor pin and solder it.

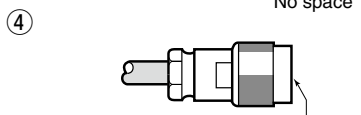

Carefully slide the plug body into place aligning the center conductor pin on the cable. Tighten the nut onto the plug body.

Be sure the center conductor is the same height as the plug body.

15 mm (0.59 in) 6 mm (0.24 in) 3 mm (0.12 in)

## ■ Front panel connection

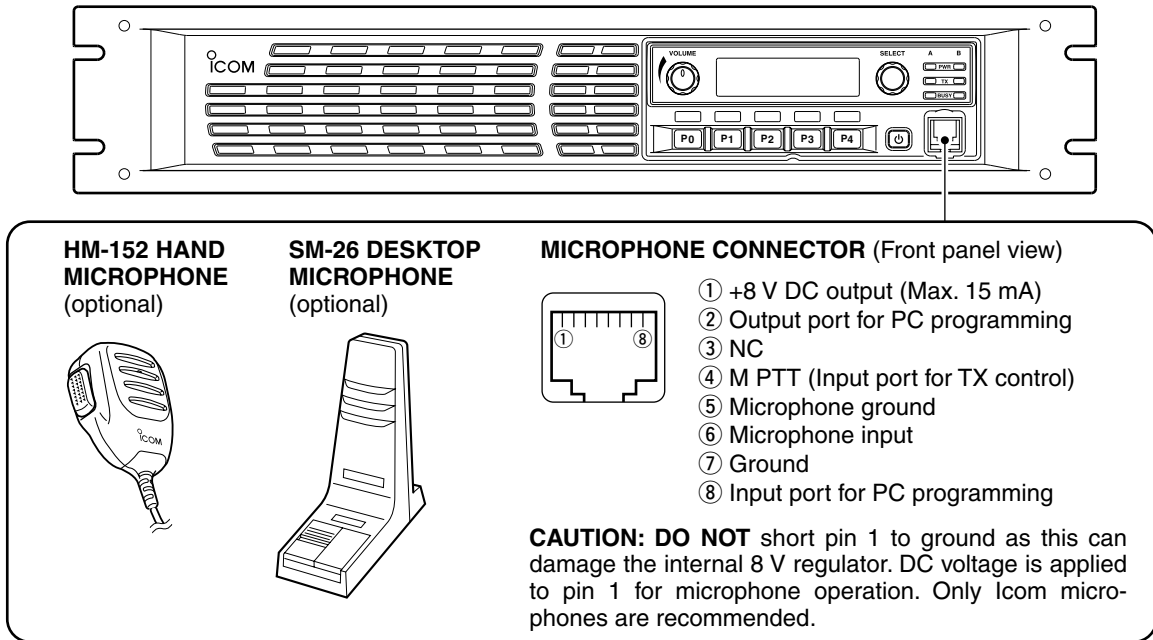

## ■ Rear panel connection

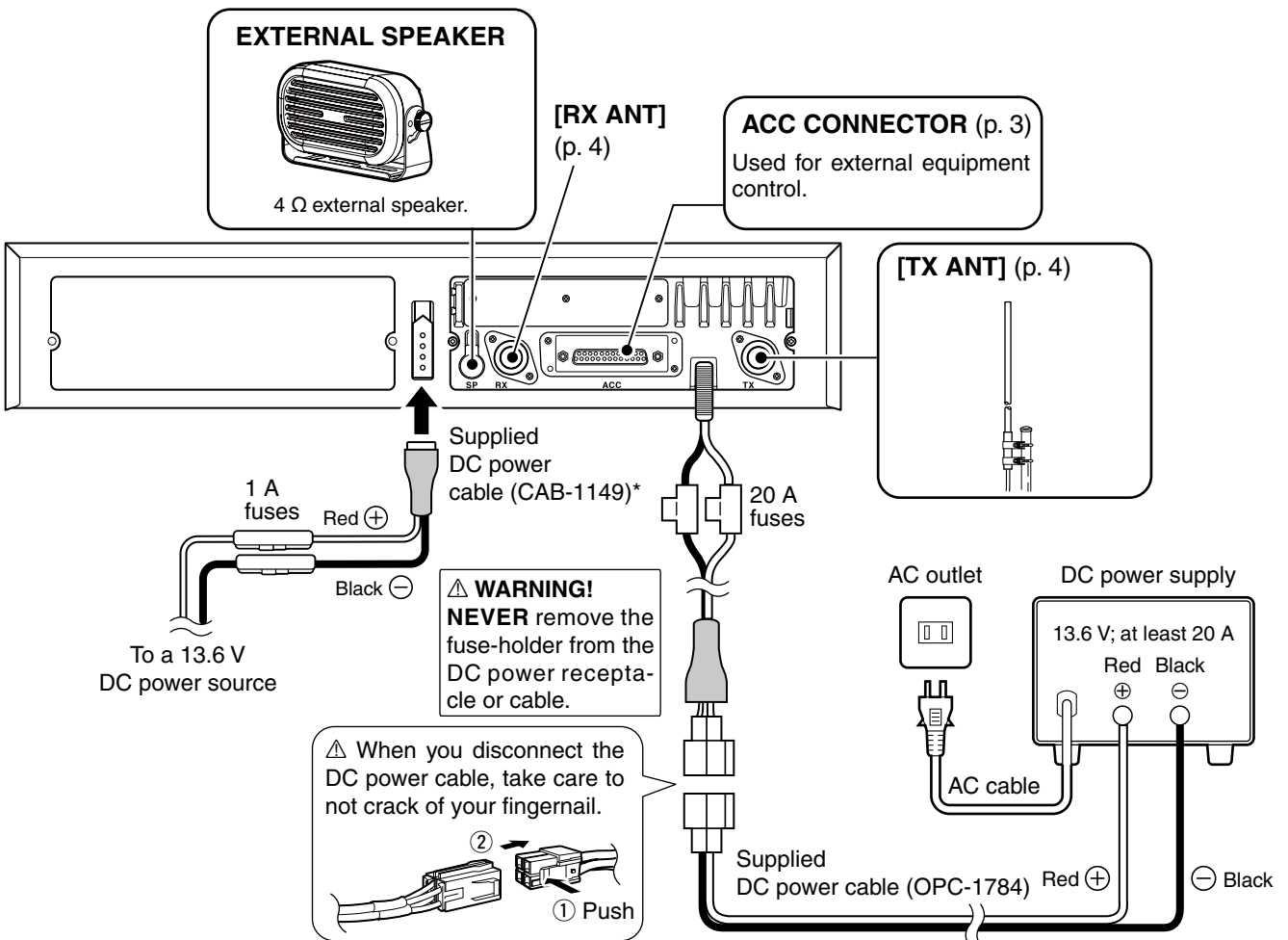

\*This connection may not be required, depending on the repeater version. The repeater rear panel may be different, depending on the repeater version.

## ■ Power supply connection

Make sure the repeater's power is turned OFF when connecting a DC power cable.

**WARNING!** NEVER apply more than 16 V DC to the DC power receptacle on the repeater rear panel. This could cause a fire or damage the repeater.

## ■ Mounting the repeater

### ◇ Using the supplied handles

The supplied handles are used when mounting the repeater into a 19 inch rack. The handles are installed on the repeater's front panel.

- ① Attach the supplied handles to both sides of the repeater's front panel with the spacers, then tighten the screws as shown below.

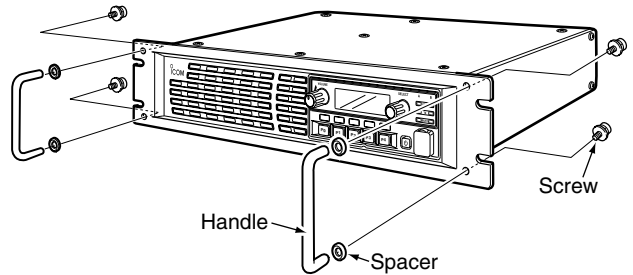

- ② The completed installation should look like the illustration below.

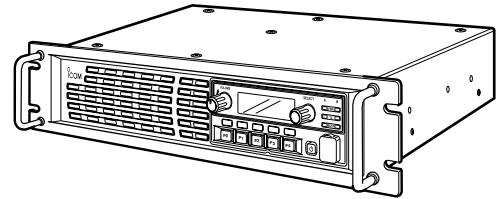

## ■ Fuse replacement

If a fuse blows, or the repeater stops functioning, find the source of the problem, repair it and then replace the damaged fuse with a new rated one.

**CAUTION: DO NOT** replace the fuse with the DC power cable connected to the repeater. Disconnect the cable to prevent electric shock and/or equipment damage.

### ◇ Line fuse replacement

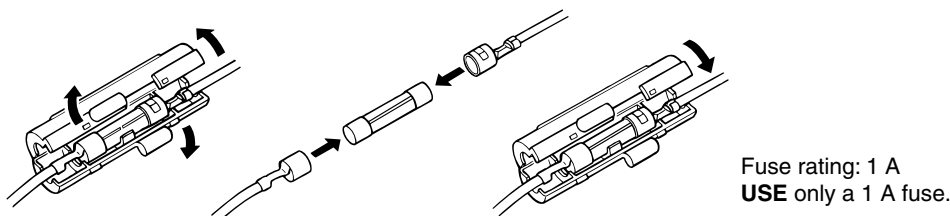
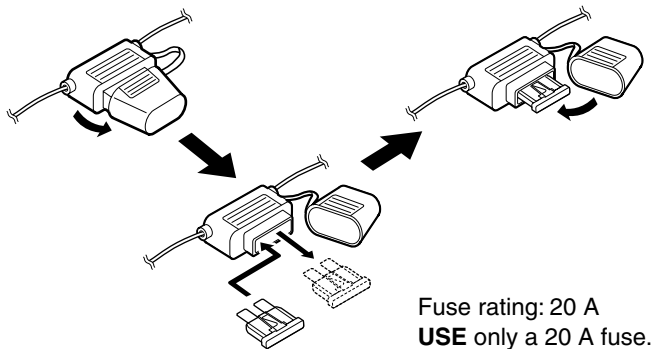

## ■ Receiving and transmitting

### ◇ Repeater operation

Ask your dealer for details of the repeater's presettings.

- When the power is turned ON, the [PWR] indicator lights green. (p. 1)
- The [TX] or [BUSY] indicator lights simultaneously while transmitting/receiving a signal.
  - The [TX] indicator lights red.
  - The [BUSY] indicator lights green.

**NOTE:** A power amplifier protector is built into the repeater. The protector is activated when the repeater temperature becomes extremely high due to long periods of transmitting to reduce the transmit output power level. The output power will return to its normal level when the repeater has cooled down.

### ◇ Base station operation

#### **Receiving**

- ① Push [POWER] to turn ON the power.
- ② Set the audio and squelch levels.
  - Rotate [SELECT]\*<sup>1</sup> fully counterclockwise in advance.
  - Rotate [VOLUME] to adjust the audio output level.
  - Rotate [SELECT]\*<sup>1</sup> clockwise until the noise just disappears.
- ③ Push [CH Up]\*<sup>2</sup> or [CH Down]\*<sup>2</sup> to select the desired channel.
  - When receiving a signal, the [BUSY] indicator lights green and audio is heard from the speaker.
  - Further adjustment of [VOLUME] to a comfortable listening level may be necessary at this point.

\*<sup>1</sup> When the [SQL Level Up/Down] key function is assigned to [SELECT].

\*<sup>2</sup> When the [CH Up]/[CH Down] key functions are assigned.

#### **Transmitting**

- ① Take the microphone off hook.
- ② Wait for the channel to become clear.
- ③ Hold down [PTT] to transmit, then speak into the microphone at your normal voice level.
- ④ Release [PTT] to receive.

#### **IMPORTANT:**

To maximize the audio quality of the transmitted signal:

1. Pause briefly after pushing [PTT].
2. Hold the microphone 5 to 10 cm (2 to 4 inch) from your mouth, then speak at your normal voice level.

## ■ Troubleshooting

The following chart is designed to help you correct problems that are not equipment malfunctions.

If you are unable to locate the cause of a problem or solve it through the use of this chart, contact your nearest Icom Dealer or Service Center.

PROBLEM	POSSIBLE CAUSE	SOLUTION	REF.
Power does not come on when <b>[POWER]</b> is pushed.	<ul style="list-style-type: none"> <li>• DC power cable is improperly connected.</li> <li>• Fuse is blown.</li> </ul>	<ul style="list-style-type: none"> <li>• Re-connect the DC power cable correctly.</li> <li>• Find the cause and repair it, then replace the fuse with a rated one.</li> </ul>	pp. 5, 6 p. 8
No sound comes from the speaker.	<ul style="list-style-type: none"> <li>• Volume level is too low.</li> <li>• The squelch is closed.</li> <li>• The audio mute function is activated.</li> <li>• A selective call or squelch function is activated such as 5-tone call or tone squelch.</li> <li>• The front speaker is set to OFF.</li> </ul>	<ul style="list-style-type: none"> <li>• Rotate <b>[VOLUME]</b> clockwise to obtain a suitable listening level.</li> <li>• While in the base operating mode, rotate <b>[SELECT]</b> to counterclockwise to open the squelch. (When the [SQL Level Up/Down] key function is assigned to <b>[SELECT]</b>.)</li> <li>• Push <b>[MONI]</b> (if assigned) to turn the audio mute function OFF.</li> <li>• Turn OFF the appropriate function.</li> <li>• Turn ON the front speaker using the optional CS-FR5000 CLONING SOFTWARE. Ask your dealer for details.</li> </ul>	p. 7 p. 7 – – –
Sensitivity is low and only strong signals are audible.	<ul style="list-style-type: none"> <li>• Antenna feedline or the antenna connector has a poor contact or is short-circuited.</li> </ul>	<ul style="list-style-type: none"> <li>• Check and reconnect (or replace if necessary), the antenna feedline or antenna connector.</li> </ul>	p. 5
Received audio is unclear or distorted.	<ul style="list-style-type: none"> <li>• Optional voice scrambler is turned OFF.</li> <li>• Scrambler code is not set correctly.</li> </ul>	<ul style="list-style-type: none"> <li>• Turn ON the optional voice scrambler.</li> <li>• Reset the scrambler code.</li> </ul>	– –
Output power is too low.	<ul style="list-style-type: none"> <li>• Output power is set to Low.</li> <li>• Power amplifier protection circuit is activated.</li> </ul>	<ul style="list-style-type: none"> <li>• Push <b>[HIGH/LOW]</b> (if assigned) to select High power.</li> <li>• Cool down the repeater or stop accessing the repeater until it has cooled down.</li> </ul>	– –
No contact possible with another station.	<ul style="list-style-type: none"> <li>• The other station is using tone squelch.</li> <li>• The operation mode is set to the Full-duplex mode. (Base station operation)</li> </ul>	<ul style="list-style-type: none"> <li>• Turn the tone squelch function ON.</li> <li>• Set the operation mode to the Simplex mode, if the other station is in the Simplex mode.</li> </ul>	– –

- **SP-35** EXTERNAL SPEAKER

Compact and easy-to-install.

Input impedance: 4  $\Omega$

Rated input: 5 W

Maximum input: 7 W

- **HM-152** HAND MICROPHONE

- **SM-26** DESKTOP MICROPHONE

- **UR-FR5000/UR-FR6000** CHANNEL EXTENSION MODULES

- **UC-FR5000** TRUNKING/NETWORK CONTROLLER

- **UT-109R** VOICE SCRAMBLER UNIT

Non-rolling type (32 codes maximum).

- **UT-110R** VOICE SCRAMBLER UNIT

Rolling type (1020 codes maximum).

/// **NOTE:** The scrambler systems of the UT-109R and UT-110R are not compatible with each other.

Some options may not be available in some countries.  
Please ask your dealer for details.

**• ABOUT VOICE CODING TECHNOLOGY**

The AMBE+2™ voice coding Technology embodied in this product is protected by intellectual property rights including patent rights, copyrights and trade secrets of Digital Voice Systems, Inc. This voice coding Technology is licensed solely for use within this Communications Equipment. The user of this Technology is explicitly prohibited from attempting to extract, remove, decompile, reverse engineer, or disassemble the Object Code, or in any other way convert the Object Code into a human-readable form. U.S. Patent Nos. #5,870,405, #5,826,222, #5,754,974, #5,701,390, #5,715,365, #5,649,050, #5,630,011, #5,581,656, #5,517,511, #5,491,772, #5,247,579, #5,226,084 and #5,195,166.

**• FOR CLASS B UNINTENTIONAL RADIATORS:**

This equipment has been tested and found to comply with the limits for a Class B digital device, pursuant to part 15 of the FCC Rules. These limits are designed to provide reasonable protection against harmful interference in a residential installation. This equipment generates, uses and can radiate radio frequency energy and, if not installed and used in accordance with the instructions, may cause harmful interference to radio communications. However, there is no guarantee that interference will not occur in a particular installation.

If this equipment does cause harmful interference to radio or television reception, which can be determined by turning the equipment off and on, the user is encouraged to try to correct the interference by one or more of the following measures:

- Reorient or relocate the receiving antenna.
- Increase the separation between the equipment and receiver.
- Connect the equipment into an outlet on a circuit different from that to which the receiver is connected.
- Consult the dealer or an experienced radio/TV technician for help.

**Count on us!**

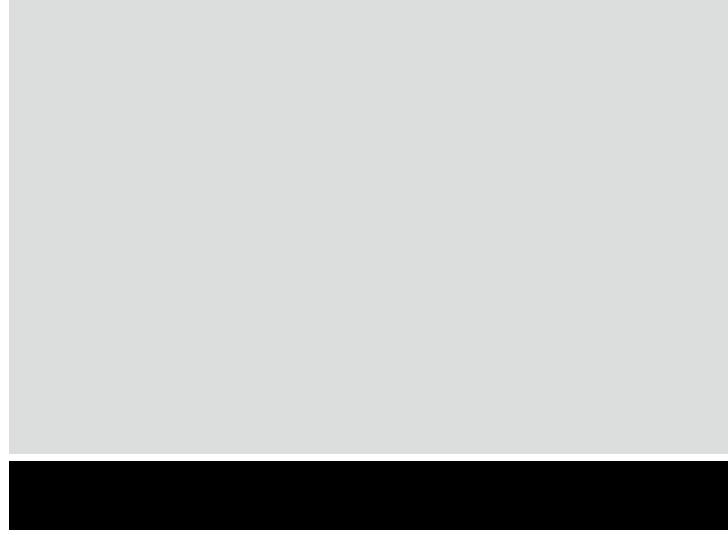

---

---

---

---

---

---

---

---