

# ICOM

## INSTRUCTION MANUAL

144 MHz FM TRANSCEIVER

**IC-S21A**

**IC-S21E**

UHF FM TRANSCEIVER

**IC-S41A**

**IC-S41E**

This device complies with Part 15 of the FCC Rules. Operation is subject to the following two conditions: (1) This device may not cause harmful interference, and (2) this device must accept any interference received, including interference that may cause undesired operation.

Icom Inc.

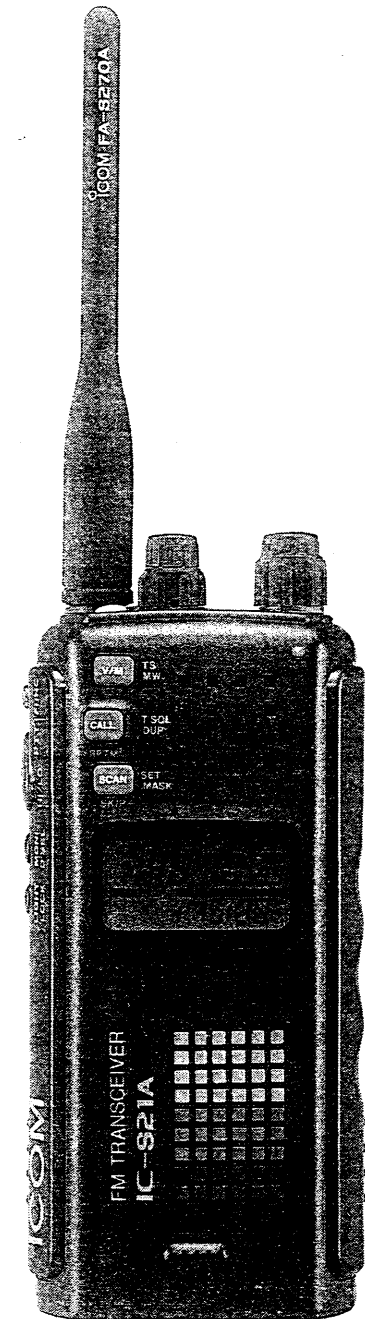

## IMPORTANT

**READ ALL INSTRUCTIONS** carefully and completely before using the transceiver.

**SAVE THIS INSTRUCTION MANUAL** – This instruction manual contains important safety and operating instructions for the IC-S21A/E and IC-S41A/E.

This instruction manual uses the IC-S21A/E for most of the example displays. Please note that only the frequency differs from the IC-S41A/E.

## EXPLICIT DEFINITIONS

**CAUTION** : Equipment damage may occur.

**NOTE** : If disregarded, inconvenience only. No risk of personal injury, fire or electric shock.

## WHEN FIRST APPLYING POWER

### ◇ Battery pack charging

- ① Insert the battery pack into the transceiver.
- ② Connect the wall charger to the [DC13.5V] jack to charge the battery pack.
  - Charging period of the BP-151 and BP-152 is approx. 15 hrs.

To  
[DC13.5V]

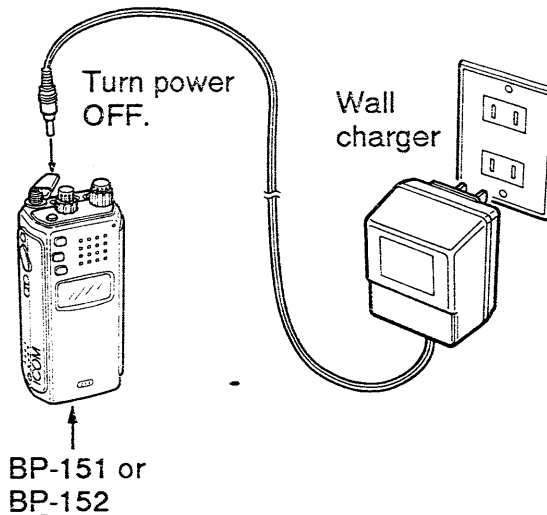

### ◇ Installing batteries into the battery case

- ① Remove the battery case from the transceiver as shown below. (Fig. 1)
- ② Install four dry cell batteries as shown below. (Fig. 2)
  - Pay attention to the polarities.
- ③ Insert the battery case into the transceiver until hearing a click.

(Fig. 1)

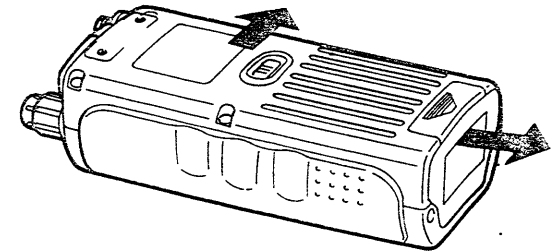

(Fig. 2)

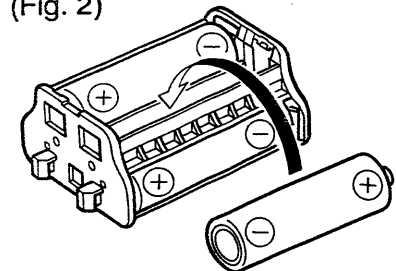

---

---

### ◇ Power ON

Push and hold [POWER] on the top panel for 1 sec. to turn power ON.

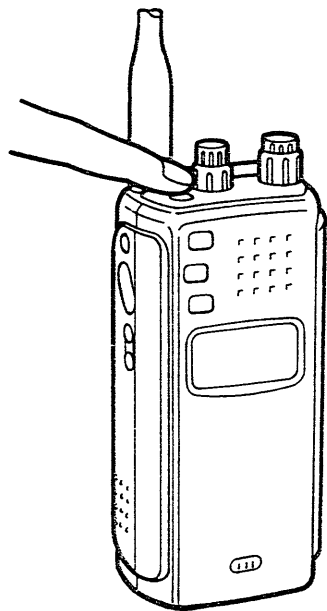

Push and hold [POWER] for 1 sec. again to turn power OFF.

### ◇ Resetting the transceiver

Reset the transceiver before operating for the first time, or when the internal CPU malfunctions.

- ① Turn power OFF.
- ② While pushing [FUNC], [MONI] and [LIGHT], push and hold [POWER] for 1 sec. to reset the CPU.

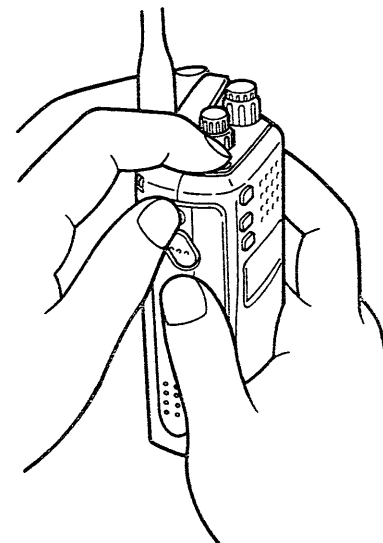

Partial resetting is alternatively available. See p. 36 for details.

## CAUTIONS

**NEVER** connect the transceiver to an AC outlet or to a power source of more than 16 V DC.

**NEVER** connect the transceiver to a power source using reverse polarity. This connection will ruin the transceiver.

**NEVER** allow children to touch the transceiver.

**AVOID** using or placing the transceiver in direct sunlight or in areas with temperatures below  $-10^{\circ}\text{C}$  ( $+14^{\circ}\text{F}$ ) or above  $+60^{\circ}\text{C}$  ( $+140^{\circ}\text{F}$ ).

**BE CAREFUL!** When transmitting for a long time with high output power, the rear panel will become hot.

The use of non-Icom battery packs/chargers may impair transceiver performance and invalidate the warranty.

Even when the transceiver power is OFF, a slight current still flows in the circuits. Remove the battery pack or case from the transceiver when not using the transceiver for a long time. Otherwise, the battery pack or installed dry cell batteries in the battery case will become exhausted.

## UNPACKING

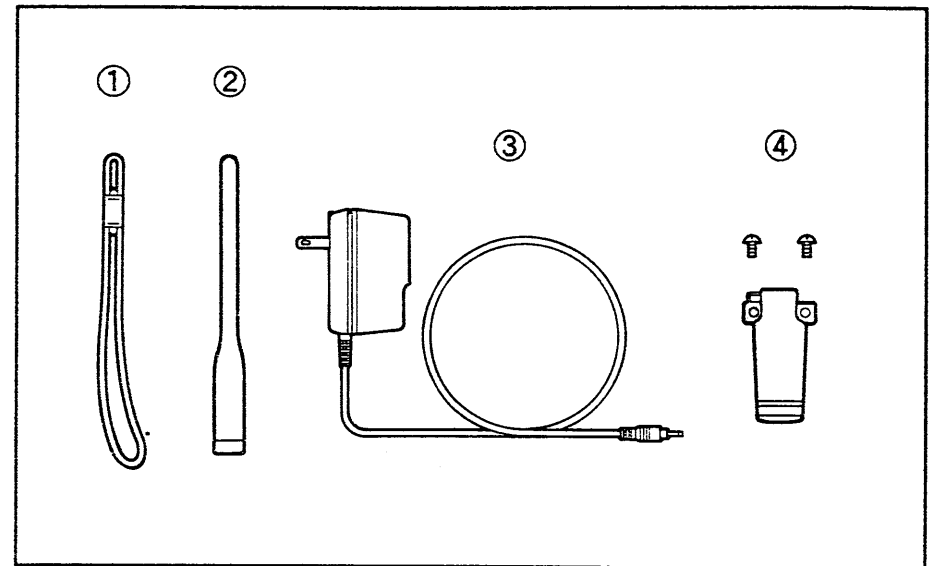

<b>Accessories included with the transceiver:</b>	<b>Qty.</b>
① Handstrap .....	1
② Antenna (FA-S270A) .....	1
③ Wall charger* .....	1
④ Belt clip and screws .....	1 set
Battery pack (BP-151) or battery case (BP-159) (attached to the transceiver) .....	1

\* Not included with versions which include a battery case.

# TABLE OF CONTENTS

IMPORTANT .....	i	6 REPEATER OPERATION .....	13-16	10 CLOCK AND TIMERS .....	27-30
EXPLICIT DEFINITIONS .....	i	■ Operation .....	13	■ Entering timer mode .....	27
WHEN FIRST APPLYING POWER .....	i-ii	■ Tone information .....	13	■ Auto power-off .....	27
CAUTIONS .....	iii	■ Subaudible tone .....	14	■ Setting the clock .....	28
UNPACKING .....	iii	■ Offset frequency .....	14	■ Power-on timer .....	29
TABLE OF CONTENTS .....	iv	■ Repeater memory .....	15	■ Power-off timer .....	30
<b>1 PANEL DESCRIPTION .....</b>	<b>1-4</b>	■ Auto repeater power control .....	15	<b>11 POCKET BEEP AND</b>	
■ Front and side panels .....	1	■ Auto repeater function .....	18	<b>    TONE SQUELCH .....</b>	<b>31-32</b>
■ Top panel .....	3	■ Tone scan .....	16	■ Optional UT-81 installation .....	31
■ Function display .....	4	<b>7 MEMORY OPERATION .....</b>	<b>17-19</b>	■ Pocket beep operation .....	32
<b>2 BATTERY PACK CHARGING .....</b>	<b>5-6</b>	■ General description .....	17	■ Tone squelch operation .....	32
■ Battery pack charging .....	5	■ Memory channel selection .....	17	<b>12 CHANNEL INDICATION MODE .....</b>	<b>33</b>
■ Charging precautions .....	5	■ Programming a memory channel .....	18	■ Channel indication mode .....	33
■ About the battery pack .....	5	■ Transferring memory contents .....	19	■ Selecting the indication mode .....	33
■ Charging connections .....	6	■ Masking a memory .....	19	<b>13 OTHER FUNCTIONS .....</b>	<b>34-36</b>
<b>3 ACCESSORY ATTACHMENT .....</b>	<b>7</b>	<b>8 CALL CHANNEL OPERATION .....</b>	<b>20</b>	■ Power saver .....	34
<b>4 SETTING A FREQUENCY .....</b>	<b>8-10</b>	■ Selecting the call channel .....	20	■ Battery voltage indication .....	34
■ VFO and memory modes .....	8	■ Programming the call channel .....	20	■ PTT lock function .....	35
■ Lock function .....	8	<b>9 SCAN OPERATION .....</b>	<b>21-26</b>	■ Beep tone on/off .....	35
■ Presetting for the tuning dial .....	9	■ Scan types .....	21	■ Receive indicator on/off .....	35
■ Using the tuning dial .....	10	■ Full scan and programmed scan .....	22	■ LCD contrast .....	35
■ Setting via $\Delta$ / $\nabla$ keys on the optional		■ Scan edge selection .....	22	■ Partial resetting .....	36
HM-75A .....	10	■ Programming scan edges .....	23	■ Optional HM-75A functions .....	36
■ LCD lighting .....	10	■ Frequency skip function .....	24	<b>14 MODE CONSTRUCTION CHART .....</b>	<b>37-38</b>
<b>5 BASIC OPERATION .....</b>	<b>11-12</b>	■ Memory skip scan .....	25	<b>15 TROUBLESHOOTING .....</b>	<b>39</b>
■ Receiving .....	11	■ Skip channel setting .....	25	<b>16 SPECIFICATIONS .....</b>	<b>40</b>
■ Transmitting .....	11	■ Scan resume condition .....	26	<b>17 OPTIONS .....</b>	<b>41-42</b>

## ■ Front and side panels

### FUNCTION SWITCH [FUNC]

While pushing this switch, other switches and the tuning dial perform secondary functions.

- "Push [FUNC] + a switch" means "while pushing the [FUNC] switch, push the switch."

### PTT SWITCH [PTT•HI/LO]

- Push and hold to transmit; release to receive. (p. 11)
- [FUNC] + [PTT•HI/LO] selects high or low output power. (p. 12)
- The tuning dial selects a low output power while pushing [FUNC] and [PTT•HI/LO]. (p. 12)

### MONITOR SWITCH [MONI•D SEL]

- Manually opens the squelch and monitors the transmit frequency. (p. 11)
- [FUNC] + [MONI•D SEL] selects the dial select step. (p. 9)

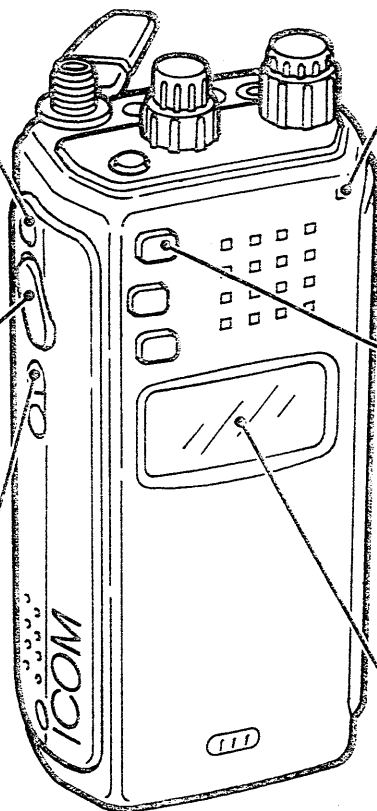

### TX/RX INDICATOR

(p. 11)

### VFO/MEMORY SWITCH [V/M•TS•MW]

- Selects VFO or memory mode. (p. 8)
- [FUNC] + [V/M•TS] (momentarily) in VFO mode enters the tuning step setting condition. (p. 9)
- [FUNC] + [V/M•MW] (for 1 sec.) in VFO mode writes the VFO contents into the selected memory channel. (p. 18)
- [FUNC] + [V/M•MW] (for 1 sec.) in memory mode transfers the selected memory contents into the VFO. (p. 19)
- [FUNC] + [V/M•MW] (for 1 sec.) in the call channel writes the VFO contents into the call channel. (p. 20)
- Generates a 1750 Hz tone while transmitting.\* (p. 13)

### FUNCTION DISPLAY

(p. 4)

\* Europe, Italy and Denmark versions only.

**CALL CHANNEL SWITCH**  
[CALL•T SQL•DUP•RPTM]

- Selects the call channel. (p. 20)
- Selects the repeater memory when pushed and held for 1 sec. (p. 15)
- [FUNC] + [CALL•T SQL] (momentarily) activates the following optional\*<sup>1</sup> functions in this sequence: subaudible tone encoder → pocket beep → tone squelch → non-tone operation. (pgs. 13, 32)
- [FUNC] + [CALL•DUP] (for 1 sec.) selects the duplex direction in this sequence: - duplex → + duplex → simplex. (p. 13)
- Generates a 1750 Hz tone while transmitting.\*<sup>2</sup> (p. 13)

**LIGHT SWITCH [LIGHT•LOCK]**

- Turns the display lighting ON and OFF. (p. 10)
- [FUNC] + [LIGHT•LOCK] turns the lock function ON and OFF. (p. 8)

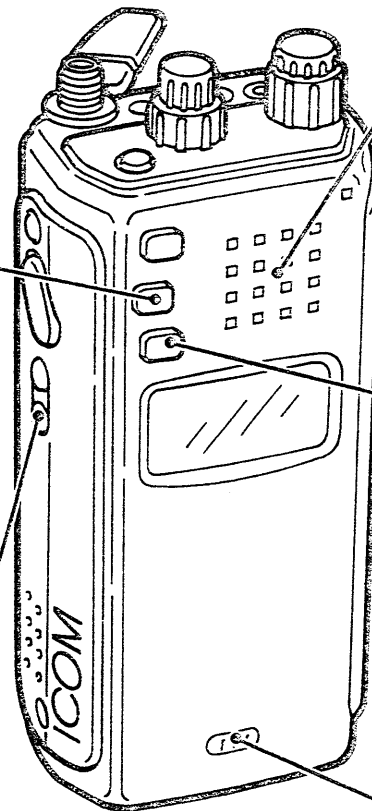

**SPEAKER**

**SCAN SWITCH [SCAN•SET•SKIP•MASK]**

- Starts scan in VFO or memory mode. (pgs. 22, 25)
- Starts tone scan when pushed and held for 1 sec. while an optional\*<sup>1</sup> tone squelch is in use. (p. 16)
- [FUNC] + [SCAN•SET] (momentarily) in VFO mode enters set mode. (p. 38)
- [FUNC] + [SCAN•SKIP] (momentarily) in memory mode sets the selected memory channel as a skip channel. (p. 25)
- [FUNC] + [SCAN•MASK] (for 1 sec.) in memory mode masks the selected memory channel. (p. 19)
- Generates a 1750 Hz tone while transmitting.\*<sup>2</sup> (p. 13)

**MICROPHONE**

\*<sup>1</sup> Built-in to the U.S.A. version.

\*<sup>2</sup> Europe, Italy and Denmark versions only.

# 1 PANEL DESCRIPTION

## Top panel

**EXTERNAL DC POWER JACK [DC13.5V]** (p. 41)  
Allows operation with a 13.5 V DC power source using the optional cables, CP-12 or OPC-254.

**CAUTION:** Operation with an external DC power source simultaneously charges batteries inside the battery case or the battery pack. This may cause battery leakage and damage the transceiver or cause battery overcharging and shorten the life of the battery pack, respectively.

**ANTENNA CONNECTOR** (p. 7)  
Connects the supplied antenna.

**POWER SWITCH [POWER]** (p. ii)  
Turns the power ON and OFF when pushed for 1 sec.

**SQUELCH CONTROL [SQL]** (p. 11)  
Varies the squelch threshold point for noise mute.

**BATTERY PACK RELEASE BUTTON** (p. i)

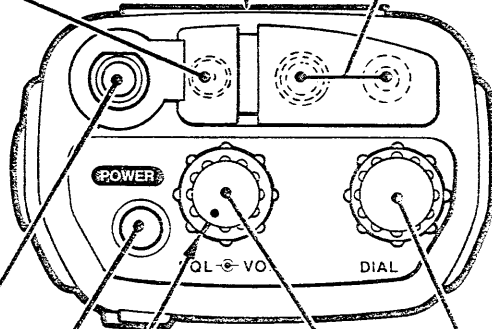

**EXTERNAL SPEAKER AND MICROPHONE JACKS [SP]·[MIC]**  
Connect an optional speaker-microphone or headset, if desired. The internal microphone will not function when either is connected. The HM-9 cannot be used. (p. 42)

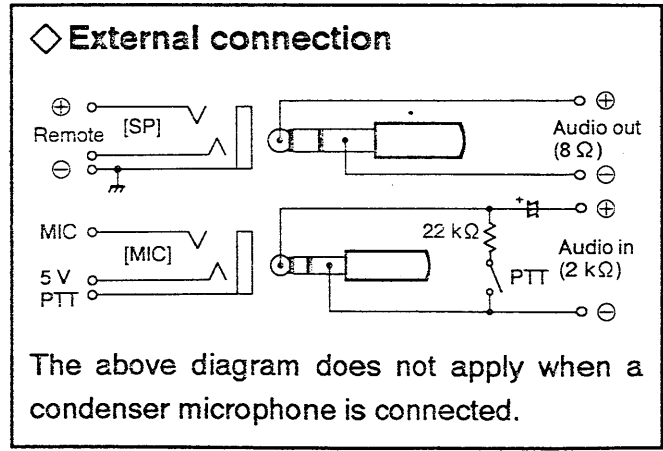

**TUNING DIAL [DIAL]**  
Sets operating frequency, memory channel and set mode contents.

**VOLUME CONTROL [VOL]** (p. 11)  
Adjusts the audio level.



## Function display

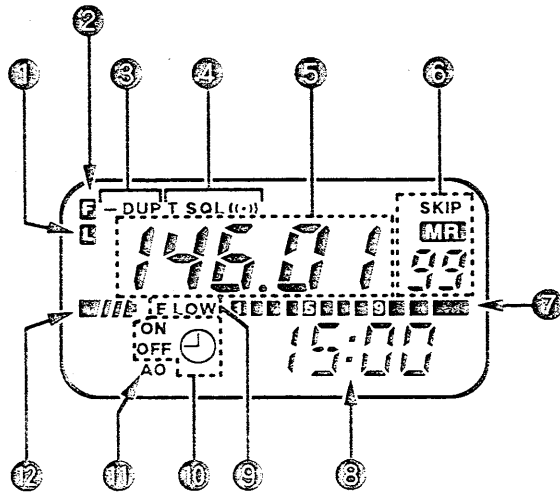

- ① **LOCK INDICATOR** (p. 8)  
Appears while the lock function is in use.
- ② **FUNCTION INDICATOR**  
Appears while the [FUNC] switch is pushed.
- ③ **DUPLEX INDICATOR** (p. 13)  
“- DUP” or “DUP” appears during semi-duplex operation (repeater operation).

- ④ **TONE INDICATOR**  
Appears while an optional\* tone squelch unit is in use.
  - “T” appears while the subaudible tone encoder is in use. (p. 13)
  - “T SQL” appears while the tone squelch is in use. (p. 32)
  - “T SQL ((••))” appears while the pocket beep function is in use. (p. 32)

\* Built-in to the U.S.A. version.
- ⑤ **FREQUENCY READOUT**  
Shows the operating frequency, set mode contents, etc.
  - The decimal point of the frequency flashes while scanning. (pgs. 21–26)
- ⑥ **MEMORY CHANNEL INDICATOR**  
Shows the selected memory channel number.
  - “ MR ” appears when memory mode is selected. (p. 17)
  - “ SKIP ” appears when the selected memory channel is set as a skip channel. (p. 25)
  - “ [ ] ” appears when the call channel is selected. (p. 20)
- ⑦ **S/R F INDICATOR**  
- Shows the relative signal strength while receiving signals. (p. 11)

- Shows the output power selection while transmitting. (p. 12)
- ⑧ **CLOCK READOUT**  
Shows the current time or the set mode selection, etc. (pgs. 28, 38)
- ⑨ **LOW POWER INDICATOR**
  - “LOW” appears while low output power is selected. (p. 12)
  - “LOW” blinks while auto repeater power control is in use. (p. 15)
  - “E LOW” appears while the economical low power (15 mW) is assigned to low output power and low power is selected. (p. 12)
- ⑩ **TIMER INDICATOR**  
“ ⊕ ” appears while the power-on or power-off timer is in use.
  - “ON” appears while the power-on timer is in use. (p. 29)
  - “OFF” appears while the power-off timer is in use. (p. 30)
- ⑪ **AUTO POWER-OFF INDICATOR**  
Appears while the auto power-off function is in use. (p. 27)
- ⑫ **BATTERY VOLTAGE INDICATOR**  
Graphically indicates the attached battery pack’s voltage. (p. 34)

## ■ Battery pack charging

The supplied\* BP-151 BATTERY PACK includes rechargeable Ni-Cd batteries and can be charged approx. 300 times. Charge the battery pack before first operating the transceiver or when the battery pack becomes exhausted. (p. 6)

\* Optional for versions which come with the BP-159 BATTERY CASE.

If you want to be able to charge the battery pack more than 300 times, the following points should be observed:

1. Avoid overcharging. The charging period should be less than 48 hours.
2. Use the battery until it becomes almost completely exhausted under normal conditions. We recommend battery charging after transmitting becomes impossible.

## ■ Charging precautions

**NEVER** attempt to charge dry cell batteries. This will cause internal liquid leakage and damage the battery case or transceiver.

**NEVER** connect two or more chargers at the same time.

Charging may not occur in extreme cold (under 0 °C; + 32 °F) or extreme heat (over + 40 °C; + 104 °F).

## ■ About the battery pack

### ◇ Operating period

Depending on the attached battery pack, the operating period of the transceiver varies. Refer to the table below.

Battery pack	Battery capacity	Approx. operating period			
		IC-S21A/E		IC-S41A/E	
		Cond. 1	Cond. 2	Cond. 1	Cond. 2
BP-151	800 mAh	5 h 40 m	1 h 55 m	6 h 00 m	2 h 00 m
BP-152	1100 mAh	7 h 45 m	2 h 40 m	8 h 15 m	2 h 50 m
BP-153	600 mAh	3 h 15 m	1 h 5 m	2 h 45 m	1 h 00 m

**Condition 1:** Tx (High) : Rx : Standby (power saved) = 1:1:8 (min.)

**Condition 2:** Tx (High) : Rx = 1:3 (min.) Operating periods are estimated values and vary depending on output power, temperature, etc.

### ◇ Battery pack life

When the operating period becomes extremely short even after charging the battery pack fully, a new battery pack is needed.

### ◇ When the battery is exhausted:

- Transmitting is interrupted while holding the [PTT] switch.
- The economical low power is automatically selected by the automatic power down function. (p. 12)
- The [POWER] switch cannot turn the power OFF. (At this time, remove the battery pack from the transceiver.)

## ■ Charging connections

### ◇ Regular charging

Connect the supplied\* wall charger as shown below when a battery pack is attached to the transceiver.

\* Optional for versions which include a battery case.

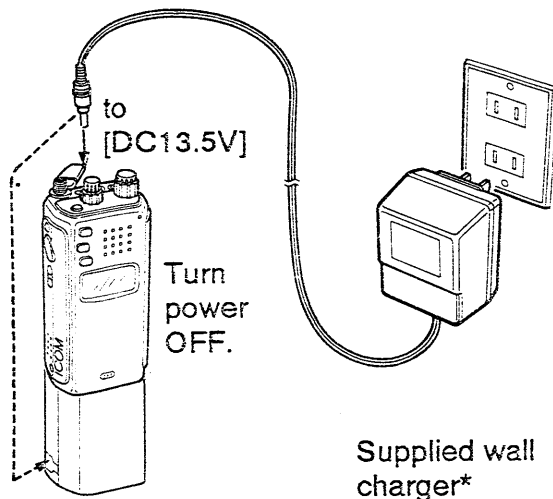

BP-153 only

- The optional CP-12 or OPC-254 with a 12–16 V DC power source can be used for charging.
- Connect a charger directly to the battery pack for charging the BP-153.
- **Charging period: Approx. 15 hrs.**

### ◇ Rapid charging

- ① Insert the optional AD-44A BATTERY PACK ADAPTER into the charging slot of the BC-79 DESKTOP CHARGER.
- ② Firmly insert a battery pack into the AD-44A.
  - Attach the AD-44B when charging the BP-151 or BP-152 alone.

Be sure to turn the power OFF.

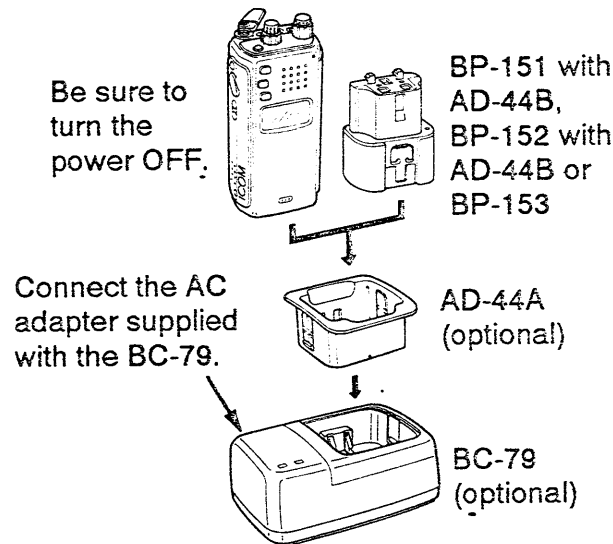

Connect the AC adapter supplied with the BC-79.

BATTERY PACK	BP-151	BP-152	BP-153
APPROX. CHARGING PERIOD	75 min.	70 min.	80 min.

### ◇ Charging during external DC operation

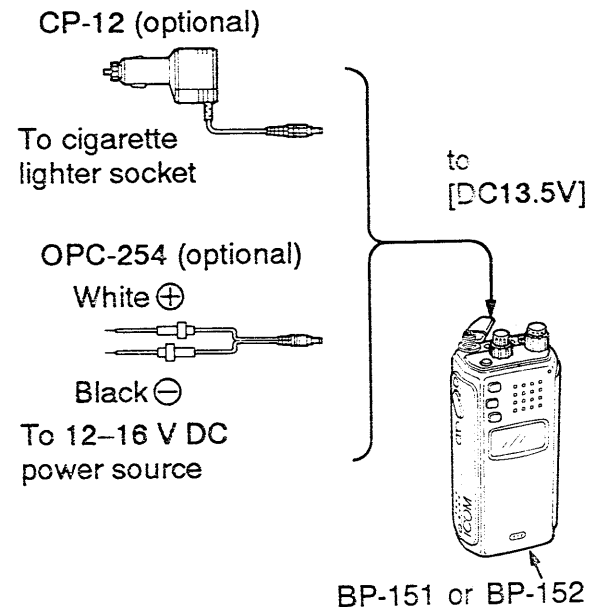

- When the BP-153 is attached, the battery pack is not charged.
- **NEVER** connect the above options when the BP-159 is attached.
- **Charging period: Approx. 15 hrs.**

# 3

## ACCESSORY ATTACHMENT

### ◇ Antenna

Insert the supplied antenna into the antenna connector and screw down the antenna as shown in the diagram below. The transceiver uses an SMA-type antenna connector.

**KEEP** the jack cover attached when jacks are not in use to avoid bad contacts.

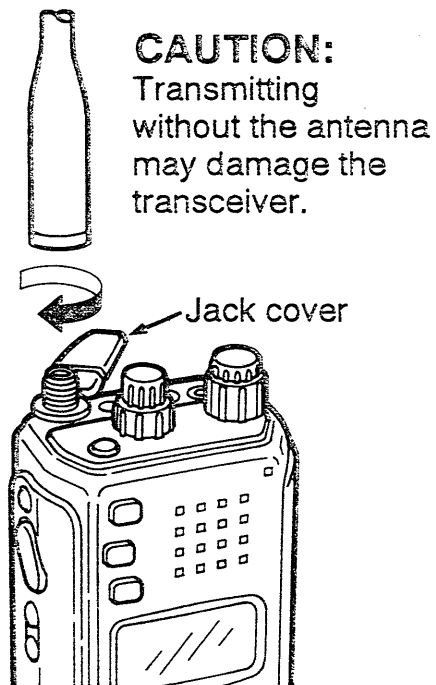

### ◇ Handstrap

Install the handstrap to the supplied belt clip as shown in the figure below. Attach the belt clip to the transceiver as described at right.

The handstrap facilitates carrying.

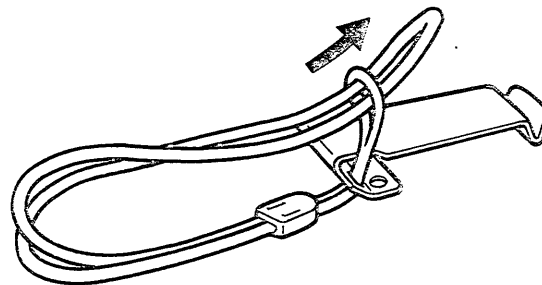

### ◇ Belt clip

Remove the plastic screws, then attach the belt clip with the supplied metal screws. Conveniently attaches to your belt.

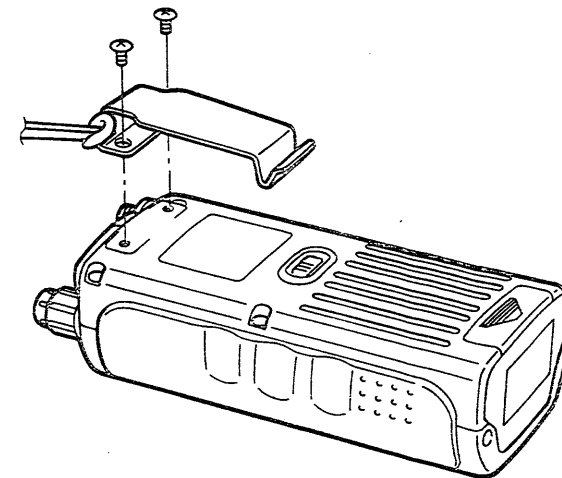

## VFO and memory modes

This transceiver has 2 normal operating modes: VFO mode and memory mode. Pushing [V/M] once or twice selects VFO mode. (p. 37)

**VFO mode (for setting a frequency):**

This mode is used for setting a desired frequency within the band range.



**Memory mode:**

This mode is used for operation of memory channels which have programmed frequencies. 100 memory channels are available to store 100 different frequencies.



**What is VFO?**

VFO is an abbreviation of Variable Frequency Oscillator. Frequencies for transmitting and receiving are generated and controlled by the VFO.

## Lock function

The lock function prevents accidental frequency changes and accidental function activation.

- ① Push [FUNC] + [LIGHT-LOCK] to turn the function ON.

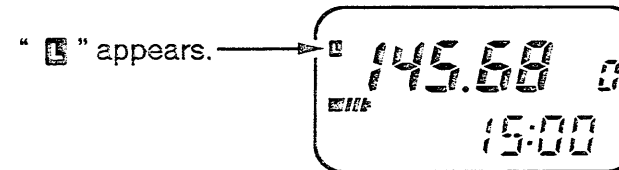

- ② To turn the function OFF, repeat step ① above.
  - "L" disappears.

**NOTE:** Output power can be selected between high and one of the low powers even if the lock function is in use.

## 4 SETTING A FREQUENCY

### ■ Presetting for the tuning dial

#### ◇ Tuning step selection

Tuning steps are the frequency change increments when you rotate the tuning dial or operate a scan. This transceiver has 8 tuning steps as follows:

- 5 kHz
- 10 kHz
- 12.5 kHz
- 15 kHz
- 20 kHz
- 25 kHz
- 30 kHz
- 50 kHz

- ① Select VFO mode if another mode has been selected.
  - Pushing [V/M] once or twice selects VFO mode. (p. 8)
- ② Push [FUNC] + [V/M•TS] momentarily to enter the tuning step setting condition.
  - Previously selected tuning step appears.
- ③ Rotate the tuning dial to select the desired tuning step.
- ④ Push [V/M] to set the selected tuning step.

**NOTE:** For convenience, select a tuning step that matches the frequency intervals of repeaters in your area.

#### [DISPLAY EXAMPLE]

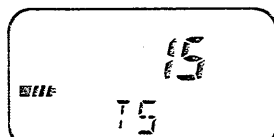

15 kHz tuning step

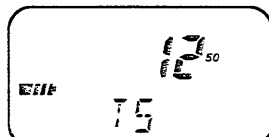

12.5 kHz tuning step

#### ◇ Setting a dial select step

In VFO mode, rotating the tuning dial while pushing [FUNC] changes the frequency in 100 kHz or 1 MHz steps, or the memory channel number.

This function is useful for quick tuning or memory channel selection in VFO mode such as when programming 2 or more memory channels.

- ① Select VFO mode with [V/M] if another mode has been selected.
- ② While pushing [FUNC], push [MONI•D SEL] some times to set the dial select step.
  - While pushing [FUNC], the selected digit (100 kHz or 1 MHz) or memory channel number blinks.
- ③ While pushing [FUNC], rotate the tuning dial to change the frequency or memory channel using the dial select tuning.

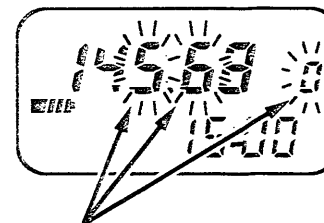

Selected digit (100 kHz or 1 MHz) or memory channel number blinks white setting the dial select step.

## ■ Using the tuning dial

- ① Select VFO mode with [V/M] if another mode has been selected.
- ② Rotate the tuning dial to set the frequency.
  - The frequency changes according to the tuning step. (p. 9)
- ③ To change the frequency quickly, rotate the tuning dial while pushing [FUNC].
  - See p. 9 for setting a dial select step.

## ■ Setting via $\Delta$ / $\nabla$ keys on the optional HM-75A

- ① Push the [B] switch once or twice to select VFO mode.
- ② Push [ $\Delta$ ] or [ $\nabla$ ] to change the frequency.
  - The frequency changes according to the tuning step. (p. 9)
  - Pushing the key for more than 0.5 sec. will activate full or programmed scan.
  - If scan starts, push [ $\Delta$ ] or [ $\nabla$ ] again to stop it.
- ③ To change the frequency quickly, push [ $\Delta$ ] or [ $\nabla$ ] while pushing [FUNC].
  - See p. 9 for setting a dial select step.

## ■ LCD lighting

The transceiver has an LCD (Liquid Crystal Display) lighting function with a 5 sec. timer. This timer can be turned OFF for continuous lighting if desired.

Push [LIGHT] to turn the lighting ON or OFF.

- When the 5 sec. timer is set, the lighting will automatically turn OFF when no switches or the tuning dial have been operated for 5 sec.
- When the continuous lighting is selected, it remains activated even when the power is turned OFF and ON again.

### USING SET MODE

#### SELECTING THE LIGHT SWITCH FUNCTION

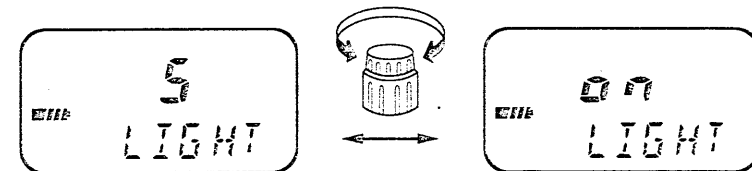

5 sec. timer is selected.

Continuous lighting is selected.

- ① Select VFO mode if another mode has been selected.
- ② Push [FUNC] + [SCAN•SET] to enter set mode.
- ③ Push [SCAN] or [V/M] until "LIGHT" appears as shown in the display.
- ④ Rotate the tuning dial to select the 5 sec. timer or continuous lighting ("on").
- ⑤ Push [PTT] to set the condition and to exit set mode.

## ■ Receiving

- ① Push [POWER] for 1 sec. to turn power ON.
- ② Set the audio level.
  - Rotate [SQL] maximum counterclockwise.
  - Rotate [VOL] to adjust the desired audio output level.
  - Rotate [SQL] clockwise until noise is muted.
- ③ Set the desired frequency with the tuning dial. (pgs. 8–10)

### When a signal is received:

- The TX/RX indicator lights up in green.
- Squelch opens and audio is emitted from the speaker.
- The S/RF indicator shows the relative signal strength.

When the [SQL] control is set too “tight” (extremely clockwise), squelch may not open for weak signals. To receive weak signals, set the squelch to a “loose” (less clockwise) position or use the monitor function.

### ◇ Monitor function

This function is used to listen to weak signals without disturbing the squelch setting or to open the squelch manually even when the tone squelch, etc. is in use.

Push and hold [MONI] to open the squelch.

- While duplex is ON for repeater operation, the transmit frequency can be monitored with [MONI].

## ■ Transmitting

**CAUTION:** Transmitting without an antenna may damage the transceiver.

- ① Set the operating frequency. (pgs. 8–10)
- ② Push and hold [PTT] to transmit.
  - The TX/RX indicator lights up in red.
  - The S/RF indicator shows the output power selection. (p. 12)
  - If the PTT lock function is activated, transmission is impossible. Cancel the function, in advance. (p. 35)
- ③ Speak into the microphone using your normal voice level. The microphone is located at the bottom of the front panel.
  - DO NOT hold the transceiver too close to your mouth or speak too loudly. This may distort the signal.
- ④ Release [PTT] to return to receive.



◇ **Output power selection**

**SELECTING HIGH OR LOW**

Push [FUNC] + [PTT·HI/LO] to select high or low output power.

- "LOW" or "E LOW" appears while a low power is selected.

**SETTING A LOW OUTPUT POWER LEVEL**

- ① Push [FUNC] + [PTT·HI/LO].
- ② While continuing to push [PTT·HI/LO], rotate the tuning dial to select the desired low power level.
  - The S/R/F indicator shows the selected level as below.
  - Maximum output power at 6.0 V DC is approx. 1.5 W (typical).
  - "E LOW" appears while the economical low (15 mW) output power is selected.

When the auto repeater power control is functioning, the "LOW" indicator blinks and the output power cannot be selected. (p. 15)

POWER SELECTION	S/R/F INDICATOR	OUTPUT POWER (typical; at 13.5 V)	
		IC-S21A/E	IC-S41A/E
HIGH	[S/R/F indicator]	6.0 W	6.0 W
LOW 3	LOW [S/R/F indicator]	4.0 W	4.0 W
LOW 2	LOW [S/R/F indicator]	1.4 W	3.0 W
LOW 1	LOW [S/R/F indicator]	1.0 W	2.0 W
E LOW	ELOW [S/R/F indicator]	15 mW	15 mW

◇ **Automatic power down function**

The automatic power down function automatically selects "E LOW" as the output power just before the battery becomes exhausted. When this function activates, the battery will be immediately exhausted.

- When using dry cell batteries with the BP-159, you can still transmit for a short time at "E LOW (15 mW)."

This function can be turned OFF if desired.

USING SET MODE

**SETTING THE AUTOMATIC POWER DOWN FUNCTION ON/OFF**

- ① Select VFO mode if another mode has been selected.
- ② Push [FUNC] + [SCAN·SET] to enter set mode.
- ③ Push [SCAN] or [V/M] until "ELOW" appears as shown in the display.
- ④ Rotate the tuning dial to turn the automatic power down function ON or OFF.
- ⑤ Push [PTT] to set the condition and to exit set mode.

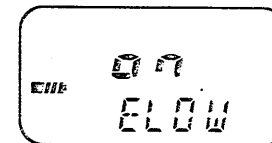

The automatic power down function is ON.

## ■ Operation

A repeater amplifies received signals and retransmits them at a different frequency. When using a repeater, the transmit frequency is shifted from the receive frequency by the offset frequency. (p. 14) It is convenient to program repeater information into a memory channel. (p. 18)

- ① Set the receive frequency (repeater output frequency).
- ② Push [FUNC] + [CALL•DUP] for 1 sec. to select - duplex or push it for 1 sec. again for + duplex.
  - “- DUP” or “DUP” appears to indicate the transmit frequency for minus shift or plus shift, respectively.
  - When the auto repeater power control is in use, “LOW” blinks and the output power is automatically selected. (p. 15)
  - The U.S.A. version has an auto repeater function. (p. 16)
- ③ Push and hold [PTT] to transmit.
  - The displayed frequency automatically changes to the transmit frequency (repeater input frequency).
  - When the repeater requires a tone, see section at right.
  - The operating condition is automatically programmed into a repeater memory. See p. 15 for details.
  - If “o.FF” appears, confirm the offset frequency. (p. 14)
- ④ Release [PTT] to receive.
- ⑤ Push and hold [MONI] to check whether the other station’s transmit signal can be directly received or not.
- ⑥ Push [FUNC] + [CALL•DUP] for 1 sec. once or twice to select simplex.

## ■ Tone information

### SUBAUDIBLE TONE

(An optional UT-81 is necessary for non-U.S.A. versions.)

- ① Push [FUNC] + [CALL•T SQL] several times (momentarily) until only “T” appears to turn ON the subaudible tone encoder.
  - To set the subaudible tone frequency, see “Subaudible tone” on the page at right.
  - For the U.S.A. version, an auto repeater function is available. When the auto repeater function type-2 (“rPT2”) is selected, the subaudible tone encoder is automatically turned ON or OFF when the operating frequency is adjusted to inside or outside of the general repeater input frequency range, respectively. (p. 16)
- ② Push [FUNC] + [CALL•T SQL] several times until “T” disappears to turn OFF the subaudible tone encoder.

### DTMF TONES

When a DTMF tone is necessary to access a repeater, use the DTMF keypad on the optional HM-55/A DTMF SPEAKER-MICROPHONE. (p. 42)

### 1750 Hz TONE

(Europe, Italy and Denmark versions only)

Push [PTT] + [V/M] or [CALL] or [SCAN] for 1–2 sec. to transmit a 1750 Hz tone call signal.

## ■ Subaudible tone USING SET MODE

(An optional UT-81 is necessary for non-U.S.A. versions.)

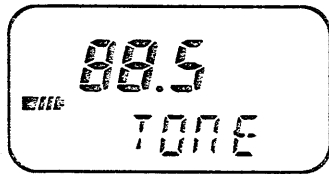

The display shows an 88.5 Hz subaudible tone frequency.

## ■ Offset frequency USING SET MODE

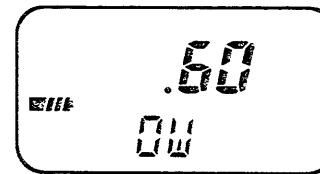

The display shows a 0.6 MHz (600 kHz) offset frequency.

- ① Select VFO mode with [V/M] if another mode has been selected.
- ② Push [FUNC] + [SCAN•SET] to enter set mode.
- ③ Push [SCAN] or [V/M] until "TONE" appears as shown in the display.
- ④ Rotate the tuning dial to select the desired frequency.
- ⑤ Push [PTT] to set the value and to exit set mode.

- ① Select VFO mode with [V/M] if another mode has been selected.
- ② Push [FUNC] + [SCAN•SET] to enter set mode.
- ③ Push [SCAN] or [V/M] until "OW" appears as shown in the display.
- ④ Rotate the tuning dial to set the desired frequency.
  - Selectable step increment is the same as the preset tuning step. (p. 9)
  - Rotating the tuning dial while pushing [FUNC] changes the frequency in 100 kHz steps.
- ⑤ Push [PTT] to set the condition and to exit set mode.

### • Subaudible tone frequency list

67.0	85.4	103.5	127.3	156.7	192.8	241.8
71.9	88.5	107.2	131.8	162.2	203.5	250.3
74.4	91.5	110.9	136.5	167.9	210.7	
77.0	94.8	114.8	141.3	173.8	218.1	
79.7	97.4	118.8	146.2	179.9	225.7	
82.5	100.0	123.0	151.4	186.2	233.6	

(Unit: Hz)

## 6 REPEATER OPERATION

### ■ Repeater memory

This transceiver has a repeater memory to store repeater information separately from regular memory channels and the call channel.

When transmitting with duplex ON, the following information is automatically programmed into the repeater memory.

- Repeater output frequency (your receive frequency).
- “- DUP” or “DUP” setting and offset frequency.
- “T” setting and subaudible tone frequency (when used).

After you operate the transceiver in simplex, you can easily select the repeater memory.

- ① Push [CALL·RPTM] for 1 sec. to select the repeater memory.
  - Programmed repeater information and “rP” appear.
  - When first applying power or after CPU resetting, the repeater memory is blanked and cannot be accessed.
- ② To return to the previous operating mode (VFO or memory mode), push [V/M].

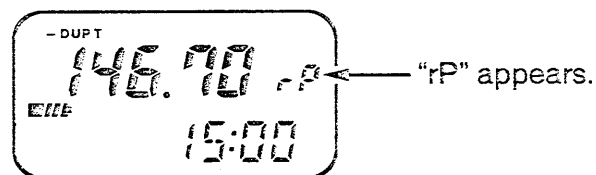

### ■ Auto repeater power control

This transceiver automatically selects the output power while in duplex operation. When receiving with duplex ON, the transceiver monitors the signal strength every 0.5 sec. and determines an output power between high, low 1–low 3. This function automatically conserves the battery power during repeater communication.

- While the function is in use and duplex is selected, the “LOW” indicator blinks and [FUNC] + [PTT·HI/LO] does not function.

Sometimes an appropriate output power may not be selected because of the repeater location, propagation conditions, etc.

#### USING SET MODE

##### SETTING THE AUTO REPEATER POWER CONTROL FUNCTION ON/OFF

- ① Select VFO mode if another mode has been selected.
- ② Push [FUNC] + [SCAN·SET] to enter set mode.
- ③ Push [SCAN] or [V/M] until “rPTPW” appears as shown in the display.
- ④ Rotate the tuning dial to turn the auto repeater power control function ON or OFF.
- ⑤ Push [PTT] to set the condition and to exit set mode.

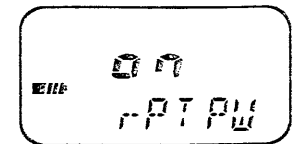

The auto repeater power control function is ON.

## Auto repeater function

(U.S.A. version only)

The U.S.A. version automatically activates or deactivates the repeater settings (duplex ON/OFF, duplex direction, tone encoder ON/OFF) when the operating frequency falls within or outside of the general repeater output frequency range, respectively. The offset frequency and subaudible tone frequency are not changed by the auto repeater function, reset these frequencies, if desired.

### USING SET MODE

#### SETTING THE AUTO REPEATER FUNCTION ON/OFF

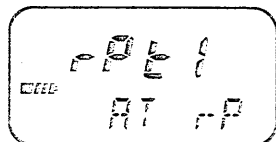

Duplex setting: Automatic  
Tone encoder: Automatic OFF

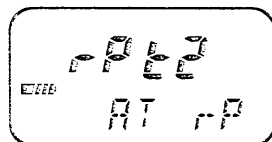

Duplex setting: Automatic  
Tone encoder: Automatic ON

- ① Select VFO mode if another mode has been selected.
- ② Push [FUNC] + [SCAN·SET] to enter set mode.
- ③ Push [SCAN] or [V/M] until "AT rP" appears as shown in the display.
- ④ Rotate the tuning dial to turn the auto repeater function ON ("rPt1" and "rPt2") or OFF.
- ⑤ Push [PTT] to set the condition and to exit set mode.

## Tone scan

The transceiver can detect the subaudible tone frequency in a received signal. By monitoring a signal that is being transmitted on a repeater input frequency, you can determine the tone frequency of the repeater.

An optional UT-81 is necessary for non-U.S.A. versions.

- ① Select VFO mode with [V/M] if another mode has been selected.
- ② Set the desired frequency to be checked for a tone frequency.
- ③ Push [FUNC] + [CALL·T SQL] one or more times until "T SQL" appears in the function display.
- ④ Push [SCAN] for 1 sec. to start the tone scan.
  - To change the scanning direction, rotate the tuning dial.
- ⑤ When the tone frequency is matched, the squelch opens and the tone frequency is programmed into the VFO.
  - The scan resumes in the selected scan resume condition.
- ⑥ Push [SCAN] to stop the scan.

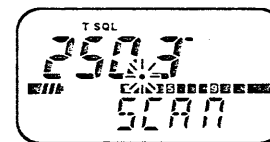

## General description

The transceiver has 100 memory channels (plus 6 scan edge memory channels) for storage of often-used frequencies. You can program the following data into each memory channel separately.

- Operating frequency (pgs. 8–10)
- Duplex direction (DUP or – DUP) (p. 13)
- Offset frequency (p. 14)
- Subaudible tone frequency\*<sup>1</sup> (p. 14)
- Subaudible tone encoder ON/OFF\*<sup>1</sup> (p. 13)
- Tone squelch ON/OFF\*<sup>1</sup> (p. 32)
- Skip information\*<sup>2</sup> (p. 25)

\*<sup>1</sup> An optional UT-81 TONE SQUELCH UNIT is necessary for non-U.S.A. versions.

\*<sup>2</sup> Except for the scan edge memory channels.

## MEMORY CHANNEL ARRANGEMENT

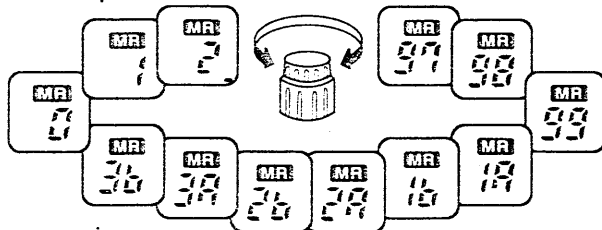

## Memory channel selection

- ① Push [V/M] once or twice to select memory mode.
  - "MR" appears.
- ② Rotate the tuning dial to select the desired memory channel.
  - To select a masked channel, rotate the tuning dial while pushing [FUNC] (p. 19)
- ③ To return to VFO mode, push [V/M].

### ◇ Using the $\Delta$ / $\nabla$ keys on the optional HM-75A

- ① Push the [B] switch once or twice to select memory mode.
  - "MR" appears.
- ② Push [ $\Delta$ ] or [ $\nabla$ ] to change the memory channel.
  - To select a masked channel, push [ $\Delta$ ] or [ $\nabla$ ] while pushing [FUNC]. (p. 19)
  - Pushing [ $\Delta$ ] or [ $\nabla$ ] for more than 0.5 sec. will activate memory scan. If scan starts, push [ $\Delta$ ] or [ $\nabla$ ] again to stop the scan.
- ③ To return to VFO mode, push the [B] switch.

## ■ Programming a memory channel

VFO mode settings, including the set mode contents such as subaudible tone frequency, etc., can be programmed into a memory channel.

- ① Select the memory channel to be programmed:
  - Push [V/M] to select memory mode. ("MR" appears.)
  - Rotate the tuning dial to select the memory channel.
  - To select a masked channel, rotate the tuning dial while pushing [FUNC].

- ② Set the desired frequency in VFO mode:
  - Push [V/M] to select VFO mode.
  - Set the desired frequency using the tuning dial.
  - Set other data (e.g. offset frequency, duplex direction, subaudible tone encoder ON/OFF and its frequency), if required.
- ③ Push [FUNC] + [V/M•MW] for 1 sec. to program.
  - 3 beeps may sound and the VFO contents (including the subaudible tone frequency, etc.) are programmed.

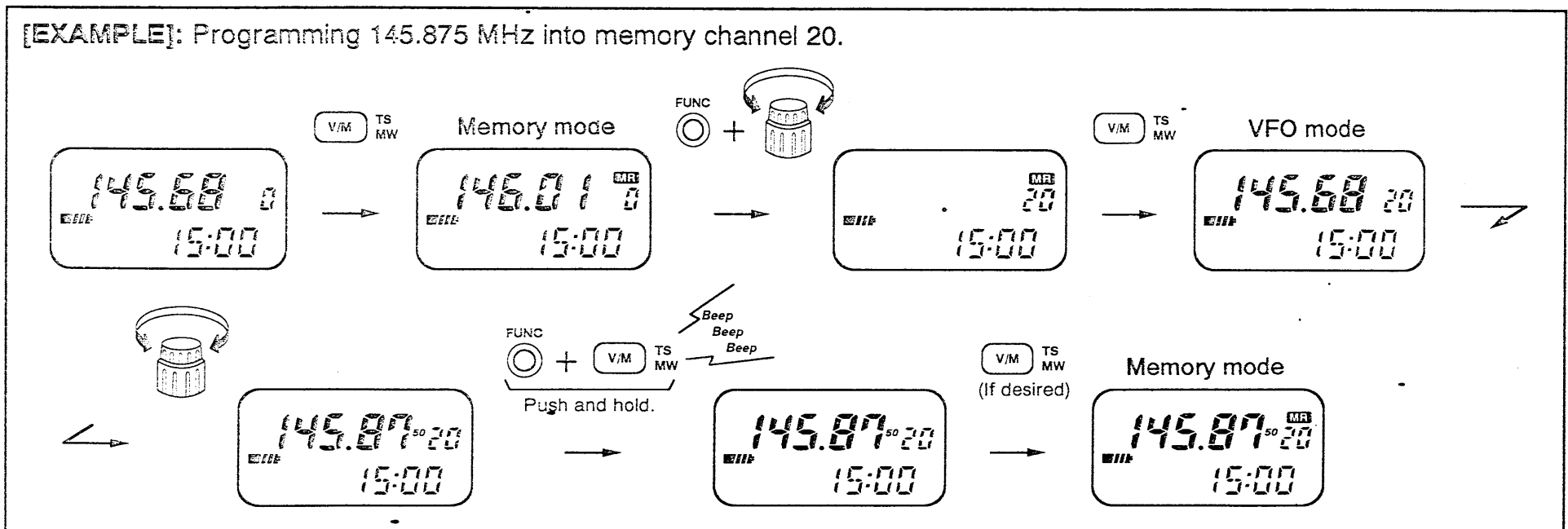

## 7 MEMORY OPERATION

### ■ Transferring memory contents

This function transfers a memory channel's contents into the VFO. This is useful when searching for signals around a memory channel's frequency and for recalling the offset frequency, subaudible tone frequency, etc.

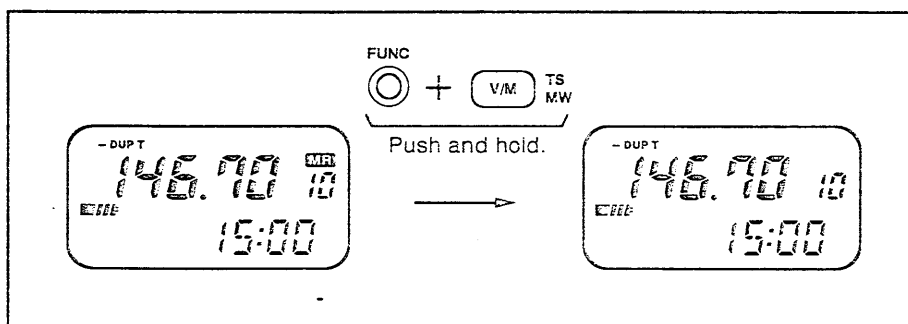

- ① Select the memory channel to be transferred:
  - Push [V/M] to select memory mode. ("MEM" appears.)
  - Rotate the tuning dial to select the memory channel.
- ② Push [FUNC] + [V/M•MW] for 1 sec.
  - "MEM" disappears as VFO mode is automatically selected.
  - 3 beeps may sound and the memory contents (including the subaudible tone frequency, etc.) are transferred.

### ■ Masking a memory

Unwanted memory channels can be masked (hidden). A masked memory channel cannot be selected for normal use. The contents of the masked memory, however, can be recalled by the following procedure.

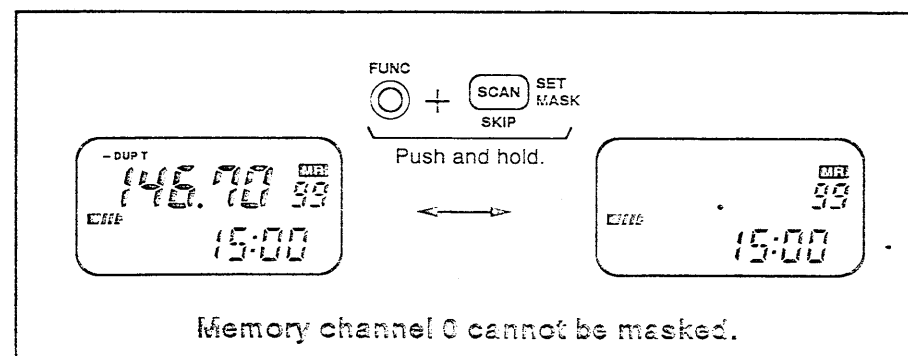

- ① Select the memory channel to be masked:
  - Push [V/M] to select memory mode. ("MEM" appears.)
  - Rotate the tuning dial to select the memory channel.
- ② Push [FUNC] + [SCAN•MASK] for 1 sec. to mask the memory channel.
  - Memory channel 0 cannot be masked.

To recall the masked memory contents, select the desired memory channel; then, repeat step ②.



## ■ Selecting the call channel

The transceiver has a one-touch-access call channel to store a most-often-used frequency for quick recall.

- ① Push [CALL] momentarily to select the call channel.

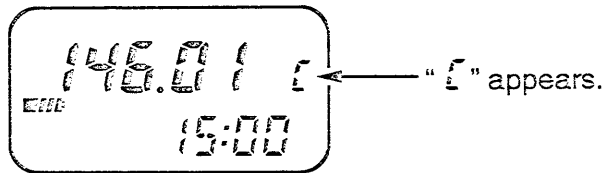

- ② To return to the previous mode (VFO or memory), push [V/M].

## ◇ Using the optional HM-75A

- ① Push the [A] switch to select the call channel.
  - “ [CALL] ” appears.
- ② To return to the previous mode (VFO or memory), push the [A] switch.
  - Pushing the [B] switch also returns to the previous mode.

## ■ Programming the call channel

In addition to an operating frequency, duplex information and subaudible tone\* information (tone encoder or tone squelch ON/OFF and its frequency) can be programmed into the call channel.

\* Optional for non-U.S.A. versions.

- ① Select VFO mode with [V/M] if another mode has been selected.
- ② Set the desired frequency using the tuning dial.
  - Set other data (e.g. offset frequency, duplex direction, subaudible tone encoder ON/OFF and its frequency), if required.
- ③ Push [CALL] momentarily to select the call channel.
  - “ [CALL] ” appears.
- ④ Push [FUNC] + [V/M•MW] for 1 sec. to program.
  - The frequency display changes to the programmed VFO contents.
  - 3 beeps may sound and the VFO contents (including the subaudible tone frequency, etc.) are programmed.

## Scan types

The transceiver has 3 scan types with skip functions and 4 resume conditions to suit your needs.

When the channel indication mode is selected, only the channel scan (same as the memory skip scan) can be used. (p. 33)

### MEMORY SKIP SCAN (p. 25)

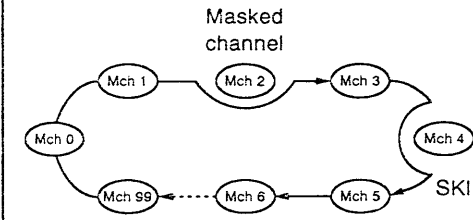

Repeatedly scans memory channels except skip and masked channels. Used for checking often-used channels and bypassing usually busy channels such as repeater frequencies.

### FULL SCAN (p. 22)

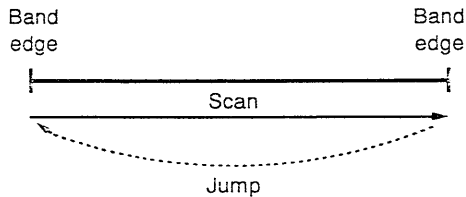

Repeatedly scans all frequencies over the entire band.

### FREQUENCY SKIP FUNCTION (p. 24)

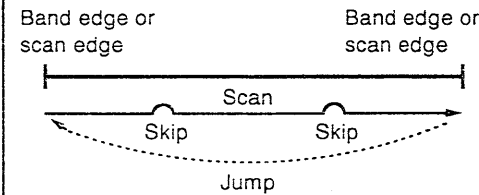

Skips unwanted frequencies that inconveniently stop scanning. This function can be turned ON or OFF in set mode.

### PROGRAMMED SCAN (p. 22)

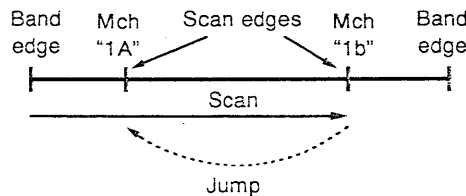

Repeatedly scans between two user-programmed frequencies. Used for checking for frequencies within a specified range such as repeater output frequencies, etc. 3 pairs of scan edges are selectable.

### SCAN RESUME CONDITION (p. 26)

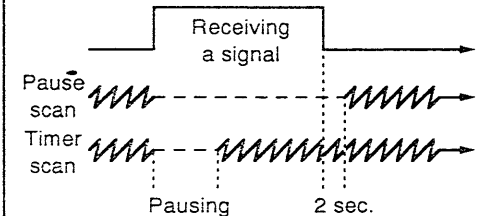

4 resume conditions are available: pause scan and 3 timer scans. When receiving a signal, pause scan pauses until the signal disappears; timer scans pause for 5, 10 or 15 sec.

## ■ Full scan and programmed scan

The procedure for full scan and programmed scan is the same. However, the transceiver action differs with the presetting as described at right.

- ① Select VFO mode with [V/M] if another mode has been selected.
- ② Set [SQL] to the point where noise is muted.
- ③ Select full scan or one of 3 programmed scan edges as described at right.
- ④ Push [SCAN] momentarily to start the scan.
  - To change the scanning direction, rotate the tuning dial.
- ⑤ To stop the scan, push [SCAN].

### ◇ Scan resume condition:

- When receiving a signal, scan resumes in one of the following ways:
  - after pausing 15 sec.
  - after pausing 10 sec.
  - after pausing 5 sec.
  - after the signal disappears.
- The scan resume condition can be selected in set mode. (p. 26)
- While scanning, rotating the tuning dial changes the scanning direction or skips a paused frequency.

## ■ Scan edge selection

USING SET MODE

The transceiver has 4 pairs of scan edges. 3 pairs of scan edges are programmable and are used for scanning within a range such as repeater output frequencies, regulated simplex frequencies, etc. The remaining scan edges are the band edges for full scan and cannot be changed.

Program the scan edge frequencies and select the scan edges in advance to activate full scan or programmed scan.

- ① Select VFO mode if another mode has been selected.
- ② Push [FUNC] + [SCAN•SET] to enter set mode.
- ③ Push [SCAN] or [V/M] until "PSC" appears as shown in the display.
- ④ Rotate the tuning dial to select full scan or one of 3 programmed scan edges.
  - "oFF" : Scan operates as full scan.
  - " 1 " : A pair of scan edge channels "1A/1b" is selected.
  - " 2 " : A pair of scan edge channels "2A/2b" is selected.
  - " 3 " : A pair of scan edge channels "3A/3b" is selected.
- ⑤ Push [PTT] to set the condition and to exit set mode.

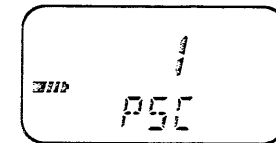

A pair of scan edge channels "1A/1b" is selected.

## 9 SCAN OPERATION

### ■ Programming scan edges

Scan edges can be programmed in the same way as memory channels. Memory channels "1A"–"3A" and "1b"–"3b" are available for programming scan edges.

- ① Push [V/M] to select memory mode.
- ② Rotate the tuning dial to select scan edge memory channel "1A," "2A" or "3A."
- ③ Set the desired frequency in VFO mode:
  - Push [V/M] to select VFO mode.
  - Rotate the tuning dial to set the desired frequency.
- ④ Push [FUNC] + [V/M•MW] for 1 sec.
  - If the beep tone is ON, 3 beeps alert you that the contents are programmed.
- ⑤ To program a frequency for the other scan edge memory channel, "1b," "2b" or "3b," repeat steps ②–④.
  - If the same frequency is programmed into a pair of scan edges and the pair is selected, programmed scan will not function.

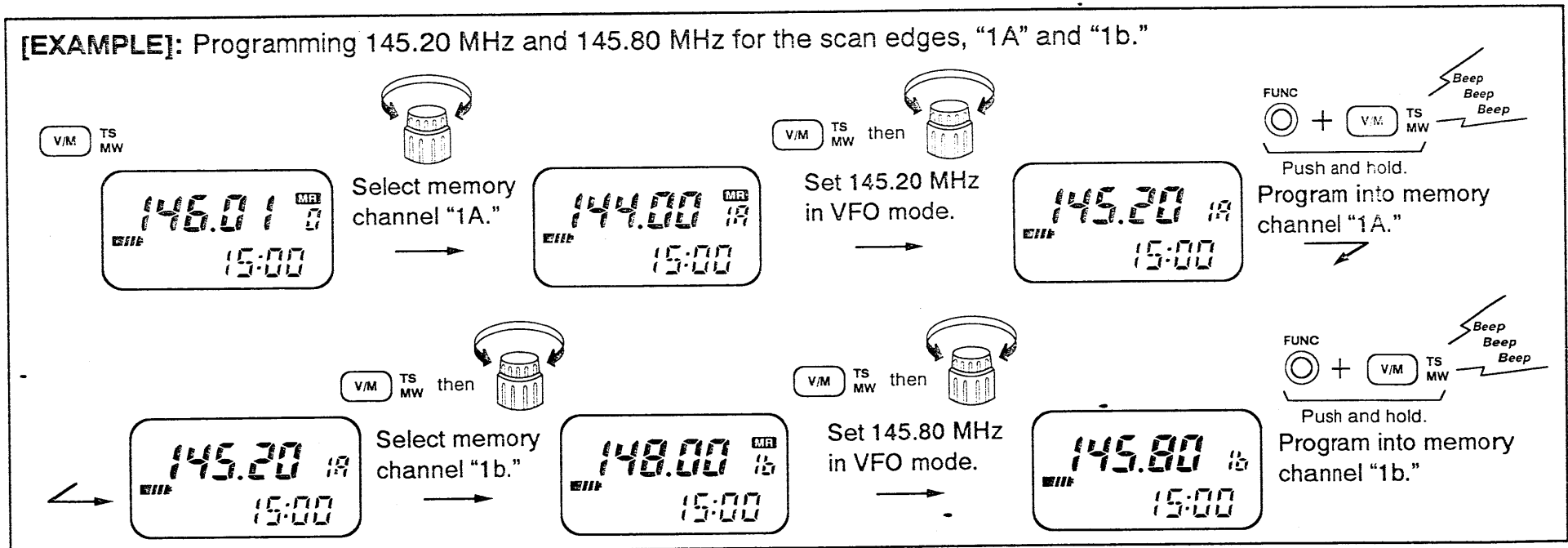

## ■ Frequency skip function

### ◇ Programming a skip frequency

Unwanted frequencies can be skipped and programmed as skip channels when full or programmed scan is pausing.

- ① Turn ON the frequency skip function as described at right.
- ② Start full scan or programmed scan. (p. 22)
- ③ Push [FUNC] + [V/M•MW] for 1 sec. to program the received frequency as a skip frequency.
  - The transceiver emits 3 beeps and the scan resumes.
  - Masked memory channels 99–10 are used in reverse sequence.
  - To scan the skip frequency after programming, cancel the skip information or mask the memory channel. (pgs. 19, 26)

### ◇ Programming a paused frequency

A paused frequency can be programmed into the selected memory channel when full or programmed scan is pausing.

- ① Turn OFF the frequency skip function as described at right.
- ② Start full scan or programmed scan. (p. 22)
- ③ Push [FUNC] + [V/M•MW] for 1 sec. to program the received frequency into the selected memory channel.
  - The transceiver emits 3 beeps and the scan resumes according to the selected resume condition.

### ◇ Frequency skip function ON/OFF

The frequency skip function can be turned OFF in set mode. In this case, the frequencies will not be skipped even if skip information is programmed and “SKIP” will not blink during full scan or programmed scan.

USING SET MODE



The frequency skip function is ON.



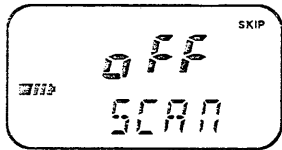

The frequency skip function is OFF.

- ① Select VFO mode if another mode has been selected.
- ② Push [FUNC] + [SCAN•SET] to enter set mode.
- ③ Push [SCAN] or [V/M] until “SCAN” and “SKIP” appear as shown in the display.
- ④ Rotate the tuning dial to turn the frequency skip function “on” or “off.”
  - When selecting “on,” the frequency skip function for full scan and programmed scan is turned ON.
- ⑤ Push [PTT] to set the condition and to exit set mode.

## 9 SCAN OPERATION

### Memory skip scan

Memory skip scan repeatedly scans memory channels except skip and masked channels. To speed up the scan interval, program the desired channel(s) as a skip channel(s) in advance.

- ① Push [V/M] to select memory mode.
  - "MR" appears.
- ② Set [SQL] to the point where noise is muted.
- ③ Push [SCAN] momentarily to start the scan.
  - To change the scanning direction, rotate the tuning dial.
- ④ To stop the scan, push [SCAN] again.

#### ◇ Scan resume condition:

- When receiving a signal, scan resumes in one of the following ways:
  - after pausing 15 sec.
  - after pausing 10 sec.
  - after pausing 5 sec.
  - after the signal disappears.
- The scan resume condition can be selected in set mode. (p. 26)
- While scanning, rotating the tuning dial changes the scanning direction or skips a paused frequency.

### Skip channel setting

Memory channels can be specified to be skipped for memory skip scan. This is useful to speed up the memory skip scan interval. When the frequency skip function is ON, skip frequencies are skipped during full scan or programmed scan. (p. 24)

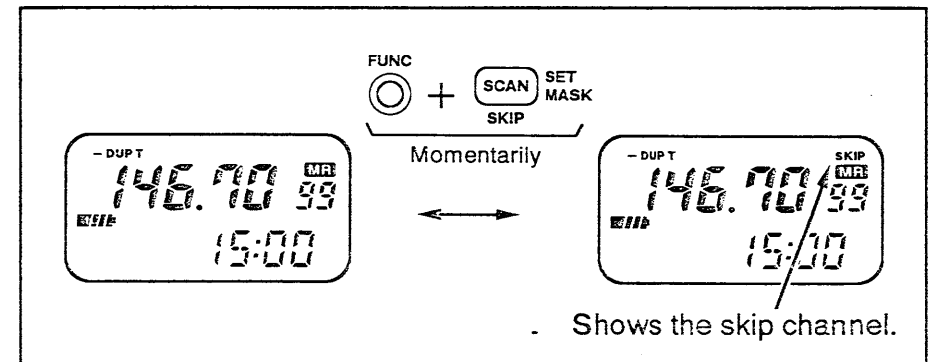

- ① Select the memory channel to be programmed as a skip channel:
  - Push [V/M] to select memory mode.
  - Rotate the tuning dial to select the desired memory channel.
- ② Push [FUNC] + [SCAN·SKIP] momentarily to set the memory channel as a skip channel.
  - "SKIP" appears.
- ③ Repeat step ② to cancel a skip channel.

## ■ Scan resume condition

*USING SET MODE*

The scan resume condition can be selected as a pause or timer scan.

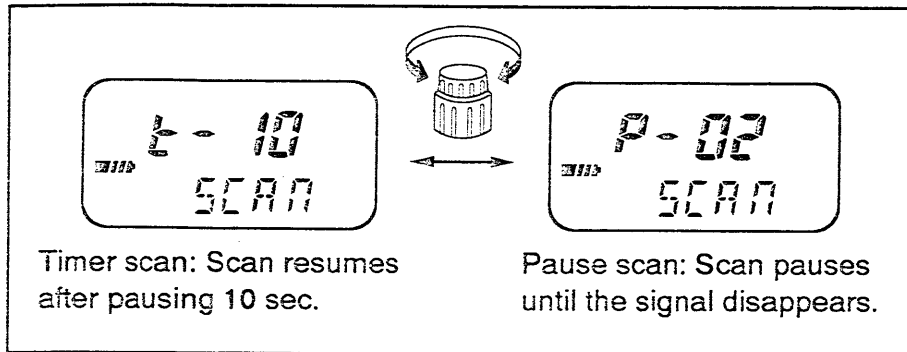

- ① Select VFO mode if another mode has been selected.
- ② Push [FUNC] + [SCAN•SET] to enter set mode.
- ③ Push [SCAN] or [V/M] until "SCAN" and "t-" or "P-" appear as shown in the display.
- ④ Rotate the tuning dial to select the desired condition.
  - "t-15" : Scan pauses 15 sec. while receiving a signal.
  - "t-10" : Scan pauses 10 sec. while receiving a signal.
  - "t-05" : Scan pauses 5 sec. while receiving a signal.
  - "P-02" : Scan pauses until the signal disappears and then resumes 2 sec. after that.
- ⑤ Push [PTT] to set the condition and to exit set mode.

# 10 CLOCK AND TIMERS

## ■ Entering timer mode

The transceiver has a built-in 24-hour clock with auto power-off, power-on timer and power-off timer functions. This timer mode is separated from the normal operating condition. To enter timer mode, perform the following.

- ① Turn power OFF.
- ② While pushing [V/M] and [SCAN], push and hold [POWER] for 1 sec. to enter timer mode.
- ③ Push [PTT] to exit timer mode and select the normal operating condition.

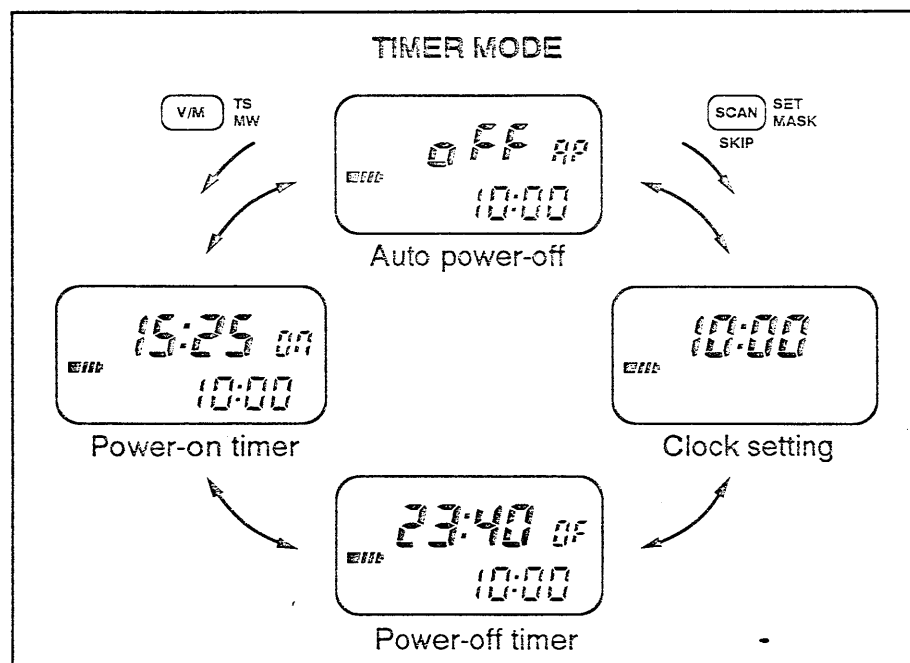

## ■ Auto power-off

The transceiver automatically turns OFF after a selected period in which no switch is pushed. This is useful if you forget to turn the power OFF.

60 min., 40 min., 20 min. and OFF can be selected. The selected period is retained even when the transceiver is turned OFF by the auto power-off function. To cancel the function, select "oFF" in step ④ below.

- ① Turn power OFF.
- ② While pushing [V/M] and [SCAN], push and hold [POWER] for 1 sec. to enter timer mode.
- ③ Push [SCAN] or [V/M] until "AP" appears to select the auto power-off display as shown at right.
- ④ Rotate the tuning dial to select the auto power-off period or turn the function OFF.
- ⑤ Push [PTT] to exit timer mode.
  - When the set period passes, the power is automatically turned OFF with 5 beeps.
  - A melody can be selected instead of the 5 beeps in set mode. (p. 35)
  - "AO" appears while the auto power-off function is in use.

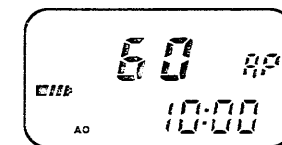

The display shows an auto power-off period of 60 min.



## ■ Setting the clock

- ① Turn power OFF.
- ② While pushing [V/M] and [SCAN], push and hold [POWER] for 1 sec. to enter timer mode.
- ③ Push [SCAN] or [V/M] until only the clock appears.
- ④ Push [FUNC] + [SCAN•SET] to enter the time setting condition.
  - The hour digit blinks.
- ⑤ Rotate the tuning dial to set the hour. (24-hour system)
- ⑥ Push [SCAN] or [V/M]; then rotate the tuning dial to set the minutes.

- ⑦ To start the clock, push [FUNC].
  - The clock starts from 0 sec. and ":" blinks.
  - To cancel time setting and exit the time setting condition, push [PTT].
- ⑧ Push [PTT] to exit timer mode.

**TIME ERROR:** ± 1 min./week

**NOTE:** CPU resetting clears the clock time. Set the time again in this case.

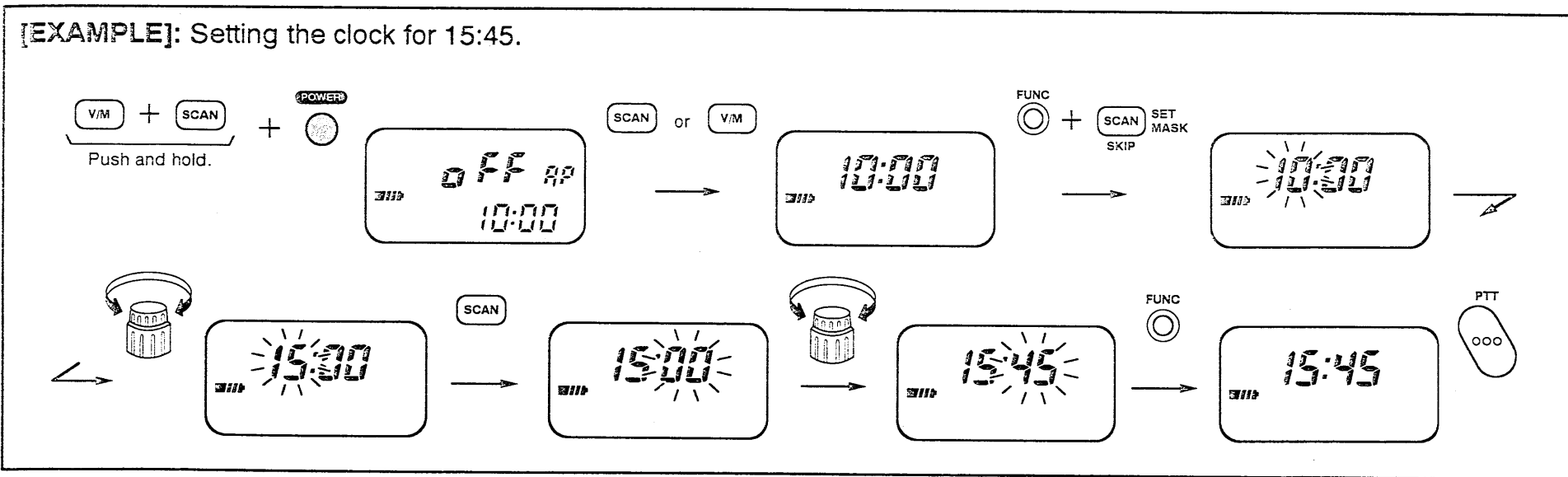

## 10 CLOCK AND TIMERS

### ■ Power-on timer

Use the power-on timer to suit your schedule and to save battery power.

- ① Turn power OFF.
- ② While pushing [V/M] and [SCAN], push and hold [POWER] for 1 sec. to enter timer mode.
- ③ Push [SCAN] or [V/M] until "On" appears to select the power-on display.
- ④ Rotate the tuning dial clockwise to turn the power-on timer ON.
  - "ON ☺" appears.
- ⑤ Set the power-on time:
  - Push [FUNC] + [SCAN•SET]; then rotate the tuning dial to set the hour.
  - Push [SCAN] or [V/M]; then rotate the tuning dial to set the minutes.
  - Push [FUNC] to enter the time.

The display shows:

power-on time is 15:25

power-on display is selected

power-on timer is activated

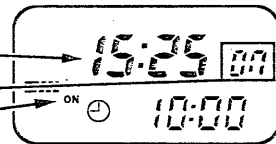

- ⑥ Push [PTT] to exit timer mode.
- ⑦ Set the frequency and audio level as desired at power ON.

- ⑧ Push [POWER] for 1 sec. to turn the power OFF.
  - When the set time arrives, the power is automatically turned ON with 5 beeps and the power-on timer ON/OFF setting is set to OFF.
  - A melody can be selected instead of the 5 beeps in set mode. (p. 35)

*Cancel the power-on timer:*

- ① Turn power OFF.
- ② While pushing [V/M] and [SCAN], push and hold [POWER] for 1 sec. to enter timer mode.
- ③ Push [SCAN] or [V/M] until "On" appears to select the power-on display.
- ④ Rotate the tuning dial counterclockwise to turn the power-on timer OFF.
  - "ON ☺" disappears.

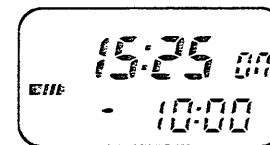

The display shows the power-on timer is cancelled.

- ⑤ Push [PTT] to exit timer mode.

## ■ Power-off timer

Like the power-on timer, the power-off timer can be set to suit your schedule and conserve battery power. When the timer is activated, the timer indicator appears in the function display and the transceiver operates normally until the pre-set time at which it will turn OFF.

- ① Turn power OFF.
- ② While pushing [V/M] and [SCAN], push and hold [POWER] for 1 sec. to enter timer mode.
- ③ Push [SCAN] or [V/M] until "OF" appears to select the power-off display.
- ④ Rotate the tuning dial clockwise to turn the power-off timer ON.
  - "OFF ⌚" appears.
- ⑤ Set the power-off time:
  - Push [FUNC] + [SCAN•SET]; then rotate the tuning dial to set the hour.
  - Push [SCAN] or [V/M]; then rotate the tuning dial to set the minutes.
  - Push [FUNC] to enter the time.

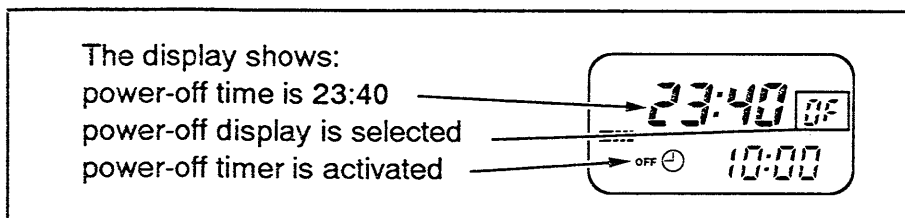

- ⑥ Push [PTT] to exit timer mode.
  - "OFF ⌚" appears while the power-off timer is in use.
  - When the set time arrives, the power is automatically turned OFF with 5 beeps and the power-off timer ON/OFF setting is set to OFF.
  - A melody can be selected instead of the 5 beeps in set mode. (p. 35)

*Cancel the power-off timer:*

- ① Turn power OFF.
- ② While pushing [V/M] and [SCAN], push and hold [POWER] for 1 sec. to enter timer mode.
- ③ Push [SCAN] or [V/M] until "OF" appears to select the power-off display.
- ④ Rotate the tuning dial counterclockwise to turn the power-off timer OFF.
  - "OFF ⌚" disappears.

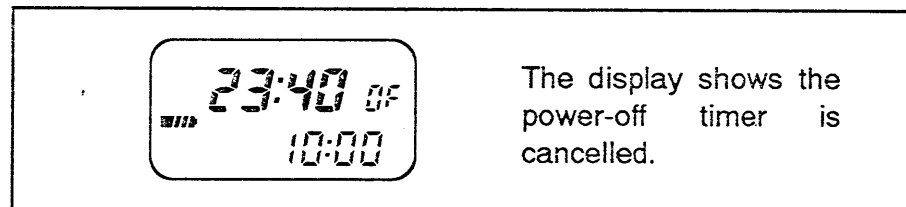

- ⑤ Push [PTT] to exit timer mode.

## Optional UT-81 installation

An optional UT-81 TONE SQUELCH UNIT is available for this transceiver. The UT-81 provides pocket beep, tone squelch and programmable tone encoder functions. The U.S.A. version already includes an equivalent unit.

- ① Turn power OFF, then remove the battery pack and/or DC power cable.
- ② Unscrew the 6 screws as shown below.

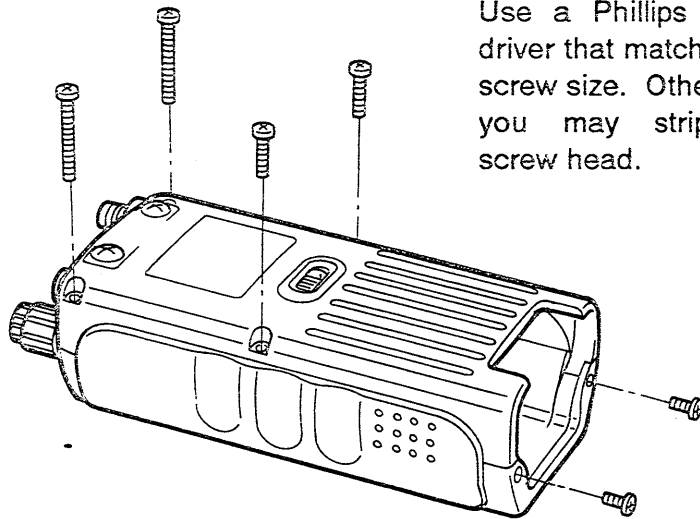

### CAUTION:

Use a Phillips screw driver that matches the screw size. Otherwise, you may strip the screw head.

- ③ Carefully separate the front and rear panels as shown below.

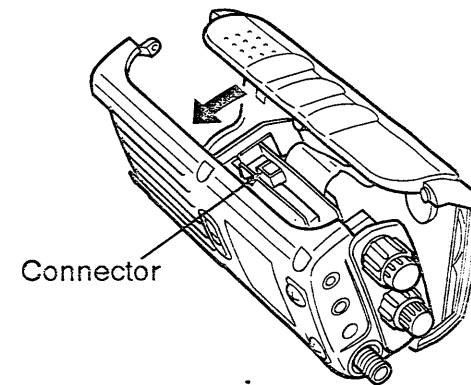

- ④ Plug in the UT-81 as shown below.
- ⑤ Reassemble the front and rear panels; then, replace the 6 screws removed in step ②.
  - **DO NOT** pinch the speaker cables.

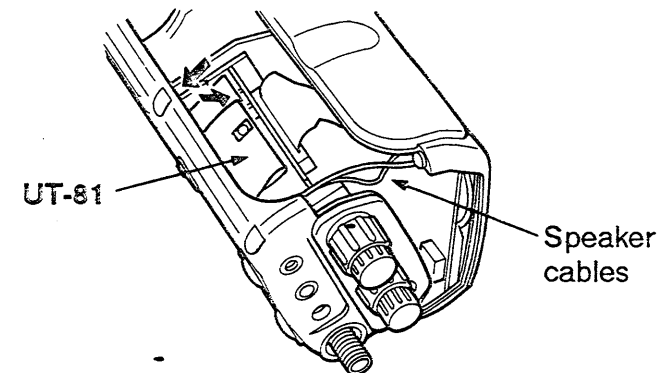

## ■ Pocket beep operation

This function uses subaudible tones for calling and can be used as a “common pager” to inform you that someone has called while you were away from the transceiver.

### ◇ Waiting for a call from a specific station

- ① Set the frequency for waiting for a call.
- ② Program the subaudible tone frequency in set mode.
  - See p. 14 for programming details.
- ③ Push [FUNC] + [CALL•T SQL] several times (momentarily) until “T SQL (1•1)” appears in the function display.
- ④ When a signal with the correct tone is received, the transceiver emits beep tones for 30 sec. and flashes “(1•1).”
- ⑤ Push [PTT] to answer or push [MONI] to stop the beeps and flashing.
  - Tone squelch is automatically selected.

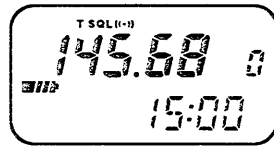

### ◇ Calling a waiting station using pocket beep

A subaudible tone matched with the station's tone frequency is necessary. Use the tone squelch at right or a subaudible tone encoder (p. 13, optional for non-U.S.A. versions).

## ■ Tone squelch operation

The tone squelch opens only when receiving a signal with the same pre-programmed subaudible tone. You can silently wait for a call from group members using the same tone.

- ① Set the frequency for using the tone squelch.
- ② Program the subaudible tone frequency in set mode.
  - See p. 14 for programming details.
- ③ Push [FUNC] + [CALL•T SQL] several times (momentarily) until “T SQL” appears in the function display.
- ④ When the received signal includes the correct tone, the squelch opens and the signal can be heard.
  - When the received signal includes an incorrect tone, the squelch does not open. Only the green indicator lights up.
  - To open the squelch manually, push and hold [MONI].
- ⑤ Operate the transceiver in the normal way (push [PTT] to transmit; release [PTT] to receive).
- ⑥ To cancel the tone squelch, push [FUNC] + [CALL•T SQL] momentarily.
  - “T SQL” disappears.

Programmed tone frequency in a memory channel cannot be changed. To change the tone frequency of a memory channel, transfer the contents into the VFO, set the desired tone frequency in set mode, then, program it into the memory channel.

# 12 CHANNEL INDICATION MODE

## ■ Channel indication mode

The transceiver has 2 indication modes: frequency indication mode and channel indication mode. The channel indication mode shows pre-programmed memory channels and does not show the operating frequency.

When the channel indication mode is selected, the following operations cannot be performed: setting an operating frequency, writing a memory channel, masking a memory channel, selecting a masked channel and changing the set mode contents.

Operation in channel indication mode is simple and the tuning dial allows for channel selection and low power selection.

### [DISPLAY EXAMPLE]

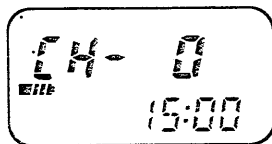

## ■ Selecting the indication mode

- ① Turn power OFF.
- ② While pushing [V/M], [CALL], [SCAN] and [LIGHT], push and hold [POWER] for 1 sec. to change the indication mode.
  - The channel indication mode and the frequency indication mode are alternately selected.

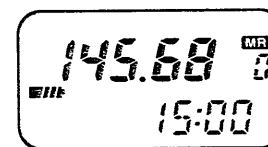
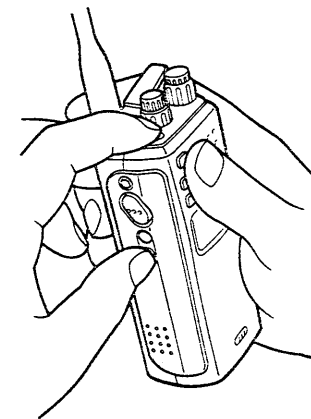

Frequency indication mode

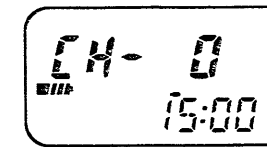

Channel indication mode

## Power saver

USING SET MODE

The power saver function reduces the current drain to conserve battery power while waiting on a frequency. The power saver duty cycle can be set to 1:1, 1:12, 1:40 or OFF. Setting it to 1:40 conserves the most power. For packet operation, the power saver should be turned OFF to receive reliable packet data.

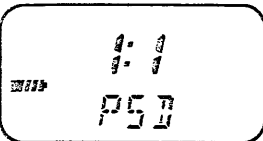
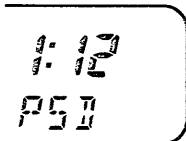
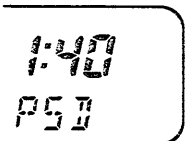
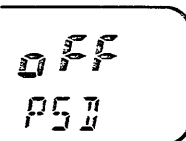
			
Standby 50 msec.	50 msec.	50 msec.	Power saver
Circuit off 50 msec.	600 msec.	2 sec.	is turned OFF.

- ① Select VFO mode if another mode has been selected.
- ② Push [FUNC] + [SCAN•SET] to enter set mode.
- ③ Push [SCAN] or [V/M] until "PSD" appears in the display.
- ④ Rotate the tuning dial to select the desired duty cycle or to turn the function OFF.
- ⑤ Push [PTT] to exit set mode.

**NOTE:** When the duty cycle is set to 1:40, signals may be clipped up to a 2 sec. max.

## Battery voltage indication

The transceiver has a battery capacity indicator that shows the connected battery voltage graphically. This indicator is designed to show dry cell battery consumption in the BP-159\* BATTERY CASE. When using the BP-151–BP-153, indicator appears; however, it is not useful. This is because once the voltage goes down, it will decrease rapidly as a result of the Ni-Cd battery characteristics.





\* Optional for versions which include the BP-151.

### ◇ Resetting the indicator

When placing new dry cell batteries in the battery case, the indicator should be reset. When the indicator shows 1 segment (  ), the dry cell batteries in the BP-159 cannot activate the transmitter circuitry.

- ① Turn power OFF.
- ② While pushing [FUNC], push and hold [POWER] for 1 sec. to reset the reference voltage.
  - The indicator shows "  " (100% voltage).

### • Relationship between indication and approx. voltage

INDICATION	 4 seg.	 3 seg.	 2 seg.	 1 seg.
6.0 V REF. VOLTAGE	5.4 V or above (89–100%)	4.7–5.4 V (78–89%)	4.1–4.7 V (67–78%)	4.1 V or below (67% or below)

## 13 OTHER FUNCTIONS

### ■ PTT lock function USING SET MODE

The PTT lock function locks the PTT switch electronically to prevent accidental transmission.

- ① Select VFO mode if another mode has been selected.
- ② Push [FUNC] + [SCAN•SET] to enter set mode.
- ③ Push [SCAN] or [V/M] until "PTTLK" appears in the display.
- ④ Rotate the tuning dial to turn the PTT lock function "on" or "off."
- ⑤ Push [PTT] to exit set mode.

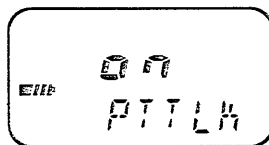

### ■ Beep tone on/off USING SET MODE

The confirmation beep can be turned ON or OFF, as desired. When "BEEP 2" is selected, a melody is emitted instead of the 5 beeps when the power-on/off timers or auto power-off is activated. These 5 beeps for timers cannot be turned OFF even when "BEEP OFF" is selected.

- ① Select VFO mode if another mode has been selected.
- ② Push [FUNC] + [SCAN•SET] to enter set mode.
- ③ Push [SCAN] or [V/M] until "BEEP" appears in the display.
- ④ Rotate the tuning dial to select the beep tone ON (1 or 2) or "off."
- ⑤ Push [PTT] to exit set mode.

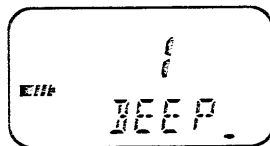

### ■ Receive indicator on/off USING SET MODE

The receive (busy) indicator can be turned ON or OFF. Turn it OFF when you want to conserve battery power.

- ① Select VFO mode if another mode has been selected.
- ② Push [FUNC] + [SCAN•SET] to enter set mode.
- ③ Push [SCAN] or [V/M] until "BUSY" appears in the display.
- ④ Rotate the tuning dial to select the receive indicator "on" or "off."
- ⑤ Push [PTT] to exit set mode.

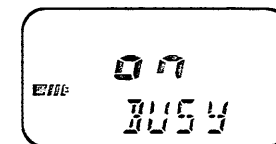

### ■ LCD contrast USING SET MODE

The LCD (Liquid Crystal Display) contrast can be selected from 4 levels (1–4) for your preference. Select a suitable level depending on the ambient light.

- ① Select VFO mode if another mode has been selected.
- ② Push [FUNC] + [SCAN•SET] to enter set mode.
- ③ Push [SCAN] or [V/M] until "LCD" appears in the display.
- ④ Rotate the tuning dial to select the desired contrast.
  - Level 4 is the highest contrast.
- ⑤ Push [PTT] to exit set mode.

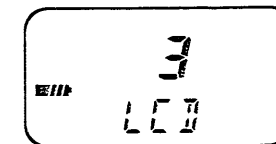



## ■ Partial resetting

If you want to initialize the operating condition (VFO frequency, VFO settings, set mode contents) without clearing the memory contents, repeater memory, clock or timer, a partial resetting function is available for the transceiver.

- ① Be sure the transceiver is not in the channel indication mode. (p. 33)
- ② Turn power OFF.
- ③ While pushing [SCAN] and [MONI], push and hold [POWER] for 1 sec. to partially reset the transceiver.

After partial resetting, the transceiver's condition is as follows:

OPERATING CONDITION or MEMORY CONTENTS	AFTER PARTIAL RESETTING
Operating mode	VFO mode
VFO frequency and VFO settings (tuning steps, subaudible tone and offset frequencies)	Initialized
Memory and call channel contents	Unchanged
Set mode contents	Initialized
Clock and timer settings	Unchanged

## ■ Optional HM-75A functions

When using an optional HM-75A with the transceiver, the switches on the HM-75A function as follows:

### ① A SWITCH

- Toggles between VFO mode and call channel.
- Generates a 1750 Hz tone\* while transmitting.

### ② B SWITCH

- Toggles between VFO and memory modes.
- Generates a 1750 Hz tone\* while transmitting.

### ③ Δ/▽ SWITCHES

- Change the frequency in the selected tuning steps in VFO mode.
- Change the memory channel in memory mode.
- Start the previously selected full scan or programmed scan when pushed for 1 sec. in VFO mode.
- Start the memory skip scan when pushed for 1 sec. in memory mode.
- Change the frequency or memory channel using dial select tuning while pushing [FUNC].

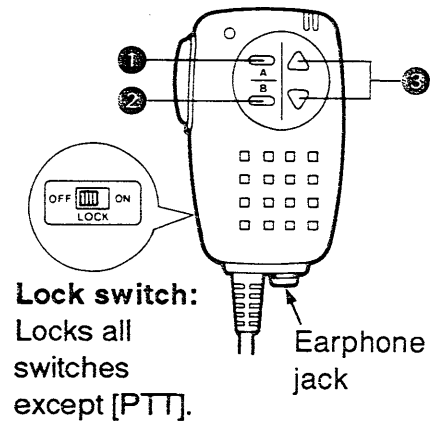

\* Europe, Italy and Denmark versions only.

# 14 MODE CONSTRUCTION CHART

Although the following chart refers only to the IC-S21A/E, the IC-S41A/E has the same mode arrangement.

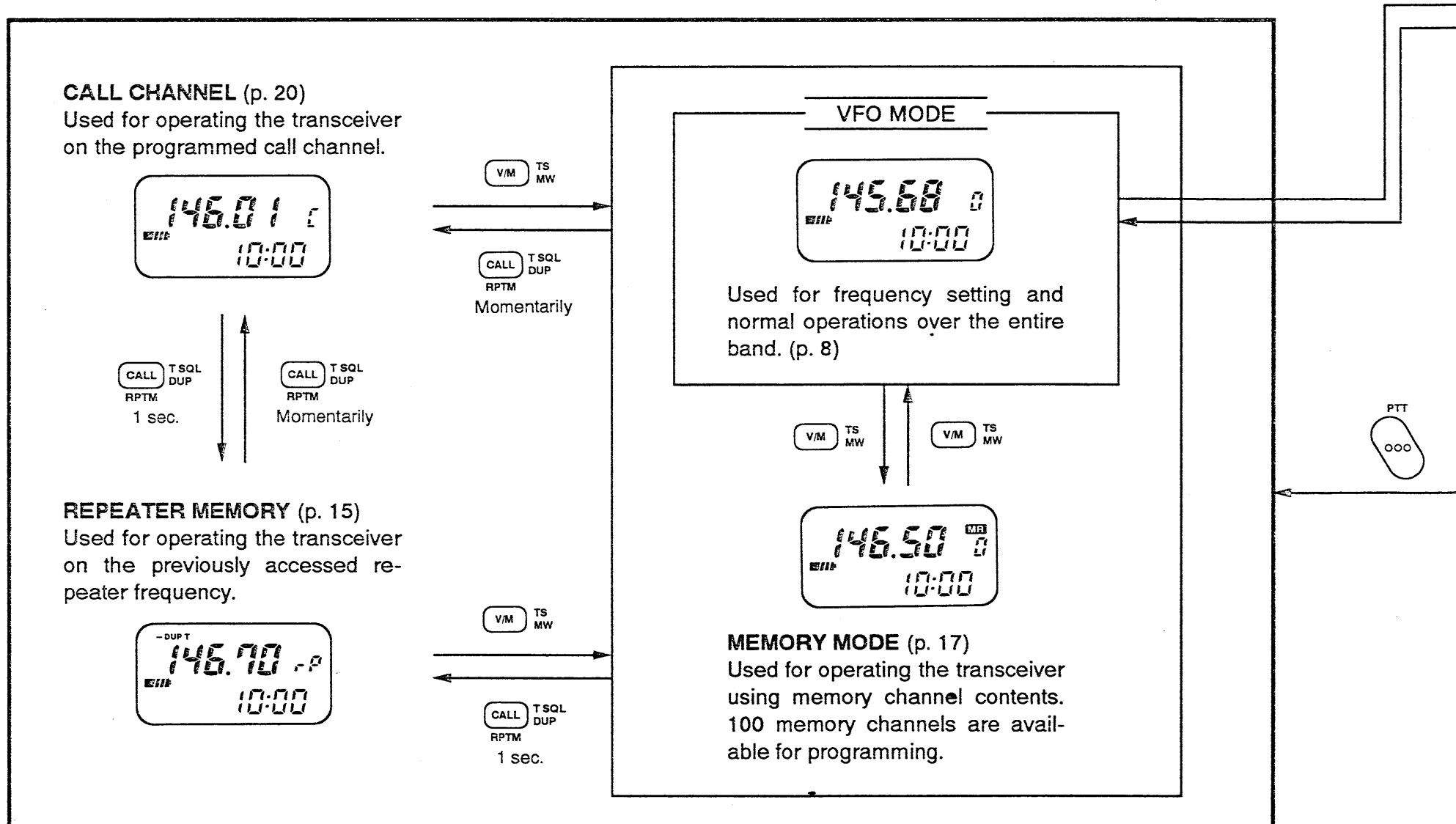

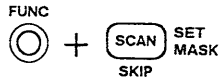

## TIMER MODE

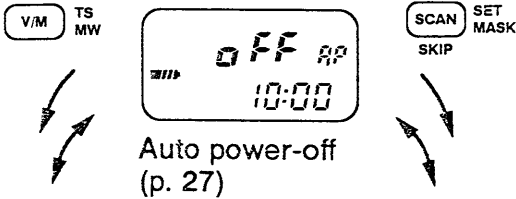

Power-on timer (p. 29)



Clock setting display (p. 28)

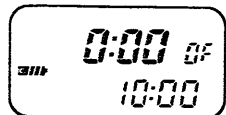

Power-off timer (p. 30)

## SET MODE

Subaudible tone frequency\*<sup>1</sup>  
(p. 14)



Auto repeater\*<sup>2</sup>  
(p. 16)



Auto repeater power control  
(p. 15)

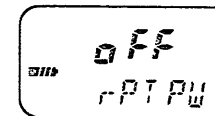

Automatic power down function  
(p. 12)

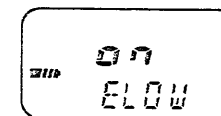

Offset frequency  
(p. 14)

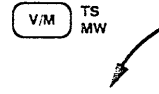
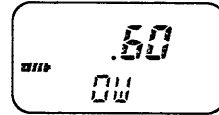

Scan resume condition (p. 26)

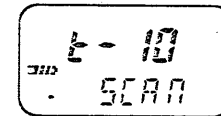

PTT lock (p. 35)

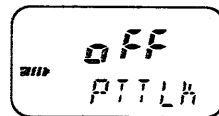

\*<sup>1</sup> Appears when an optional UT-81 is installed, except for the U.S.A. version.

\*<sup>2</sup> Appears for the U.S.A. version only.

**NOTE:** These displays show the default settings (except for the offset frequency setting).

Frequency skip function (p. 24)

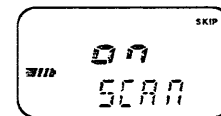

Beep tone (p. 35)

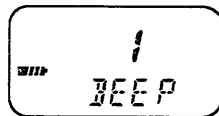

Scan edge selection (p. 22)

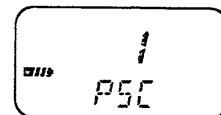

Power saver duty cycle (p. 34)

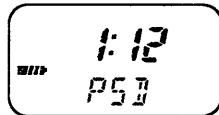

Receive indicator (p. 35)

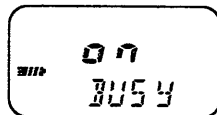

LCD lighting timer (p. 10)

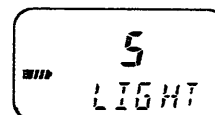

LCD contrast (p. 35)

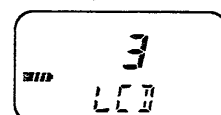

# 15 TROUBLESHOOTING

If your transceiver seems to be malfunctioning, please check the following points before sending it to a service center.

PROBLEM	POSSIBLE CAUSE	SOLUTION	REF.
<ul style="list-style-type: none"> <li>No power comes on.</li> </ul>	<ul style="list-style-type: none"> <li>The battery is exhausted. (A slight current flows in the circuits even when the power is OFF.)</li> <li>Poor plug connection to the external DC power cable.</li> </ul>	<ul style="list-style-type: none"> <li>Charge the battery pack or place new dry cell batteries in the battery case. (Remove the battery pack if you will not be using the transceiver for a long time.)</li> <li>Check the connector or remove and replace the cable.</li> </ul>	<p>pgs. i, 6</p> <p>—</p>
<ul style="list-style-type: none"> <li>Power cannot be turned OFF.</li> </ul>	<ul style="list-style-type: none"> <li>The battery became exhausted during operation.</li> </ul>	<ul style="list-style-type: none"> <li>Charge the battery pack or place new dry cell batteries in the battery case, then, turn the power OFF.</li> </ul>	<p>pgs. i, 6</p>
<ul style="list-style-type: none"> <li>No sound comes from the speaker.</li> </ul>	<ul style="list-style-type: none"> <li>[SQL] is turned too far clockwise.</li> <li>An external speaker or earphone is connected.</li> <li>Optional pocket beep or tone squelch is activated.</li> </ul>	<ul style="list-style-type: none"> <li>Rotate [SQL] counterclockwise.</li> <li>Unplug the speaker or earphone.</li> <li>Push [FUNC] + [CALL•T SQL] once or twice (momentarily) to turn the function OFF.</li> </ul>	<p>p. 11</p> <p>—</p> <p>p. 32</p>
<ul style="list-style-type: none"> <li>Transmitting is impossible.</li> </ul>	<ul style="list-style-type: none"> <li>The PTT lock function is activated.</li> </ul>	<ul style="list-style-type: none"> <li>Cancel the PTT lock function using set mode.</li> </ul>	<p>p. 35</p>
<ul style="list-style-type: none"> <li>Frequency cannot be set.</li> </ul>	<ul style="list-style-type: none"> <li>Memory mode, the call channel or the repeater memory is selected.</li> <li>The lock function is activated.</li> </ul>	<ul style="list-style-type: none"> <li>Push [V/M] once or twice to select VFO mode.</li> <li>Push [FUNC] + [LIGHT•LOCK] to deactivate the lock function.</li> </ul>	<p>p. 8</p> <p>p. 8</p>
<ul style="list-style-type: none"> <li>Scan cannot be activated.</li> </ul>	<ul style="list-style-type: none"> <li>The squelch is open.</li> </ul>	<ul style="list-style-type: none"> <li>Rotate [SQL] clockwise until noise disappears.</li> </ul>	<p>pgs. 22, 25</p>
<ul style="list-style-type: none"> <li>Frequency is not displayed.</li> </ul>	<ul style="list-style-type: none"> <li>The channel indication mode is selected.</li> </ul>	<ul style="list-style-type: none"> <li>While pushing [V/M], [CALL], [SCAN] and [LIGHT], push and hold [POWER] for 1 sec.</li> </ul>	<p>p. 33</p>
<ul style="list-style-type: none"> <li>The VFO contents and set mode settings are initialized.</li> </ul>	<ul style="list-style-type: none"> <li>The internal memory backup battery is exhausted because no charging has been performed for a long time.</li> </ul>	<ul style="list-style-type: none"> <li>Charge the battery pack or place new dry cell batteries in the battery case. The memory backup battery is simultaneously charged.</li> </ul>	<p>pgs. i, 6</p>

# SPECIFICATIONS 16

		IC-S21A/E	IC-S41A/E
Frequency coverage (Guaranteed range of VHF is 144–148 MHz.)	U.S.A.	144–148 MHz	440–450 MHz
	Asia, Italy	Tx: 144–148 MHz Rx: 138–174 MHz	430–440 MHz
	Australia	144–148 MHz	430–440 MHz
	Europe	144–146 MHz	430–440 MHz
	Denmark	144–146 MHz	432–438 MHz
	Taiwan	145–146 MHz	430–432 MHz
Mode		FM (F3E)	
Frequency stability		± 10 ppm (0 °C to + 50 °C; + 32 °F to + 122 °F)	
Tuning steps		5, 10, 12.5, 15, 20, 25, 30 or 50 kHz	
Antenna impedance		50 Ω (nominal)	
Usable battery pack/case		BP-151–BP-153, BP-159	
External DC power		4–16 V DC (negative ground)	
Current drain (at 13.5 V, typical)	Tx	High	1.8 A
		Low 1	1.0 A
		E LOW	90 mA
	Rx	Rated audio	160 mA
Power saved		8 mA (average)	
Usable temperature range		– 10 °C to + 60 °C; + 14 °F to + 140 °F	
Dimensions (with BP-151) (projections not included)		54(W) × 111(H) × 35.5(D) mm; 2.1(W) × 4.4(H) × 1.4(D) in	
Weight (with BP-151)		315 g; 11.1 oz	

		IC-S21A/E	IC-S41A/E	
TRANSMITTER	Selectable output power* (at 13.5 V)	6.0 W, 4.0 W, 1.4 W, 1.0 W, 15 mW	6.0 W, 4.0 W, 3.0 W, 2.0 W, 15 mW	
	Modulation system	Variable reactance frequency modulation		
	Max. freq. deviation*	± 5 kHz		
	Spurious emissions*	Less than – 60 dB (at high power) Less than – 40 dB (at E LOW)		
Microphone impedance		2 kΩ		
RECEIVER	Receive system	Double-conversion superheterodyne		
	Intermediate frequencies	1st	30.85 MHz	35.8 MHz
		2nd	455 kHz	
	Sensitivity* (for 12 dB SINAD)	Less than 0.16 μV		
	Squelch sensitivity	Less than 0.13 μV (at threshold)		
	Selectivity	More than 15 kHz/– 6 dB Less than 30 kHz/– 60 dB		
	Spurious and image rejection ratio*	More than 60 dB (Except half of image frequency)		
Audio output power* (at 13.5 V)	More than 300 mW (at 10% distortion with an 8 Ω load)			
Audio output impedance		8 Ω		

\* Specifications guaranteed at a transceiver temperature of +25°C (+77°F).

All stated specifications are subject to change without notice or obligation.

# 17 OPTIONS

## ◇ Battery packs and chargers

BATTERY PACK	HEIGHT (with transceiver)	VOLTAGE	CAPACITY	CARRYING CASE
BP-151	111 mm, 4.4 in	6.0 V	800 mAh	LC-109
BP-152	126.8 mm, 5.0 in	6.0 V	1100 mAh	LC-111
BP-153	174.7 mm, 6.9 in	12.0 V	600 mAh	LC-110
BP-159	111 mm, 4.4 in	Battery case R6 (AA) size × 4		LC-109

**CP-12**  
CIGARETTE LIGHTER  
CABLE WITH NOISE FILTER  
For operation and charging  
with a 12 V cigarette lighter  
socket.

**OPC-254**  
DC POWER CABLE  
For operation and charging  
with an external power supply.

**BC-74A/E/D/V**  
WALL CHARGER  
Regularly charges a battery  
pack.

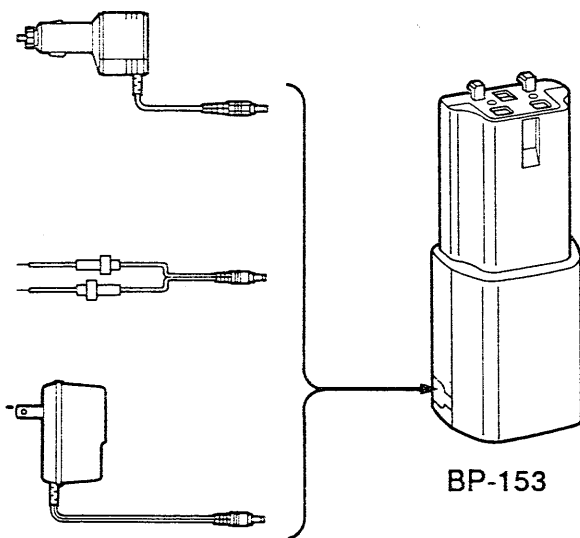

BP-153

- The BC-73E/D cannot be used as the charging power source.

## BC-79 DESKTOP CHARGER + AD-44 BATTERY PACK ADAPTER

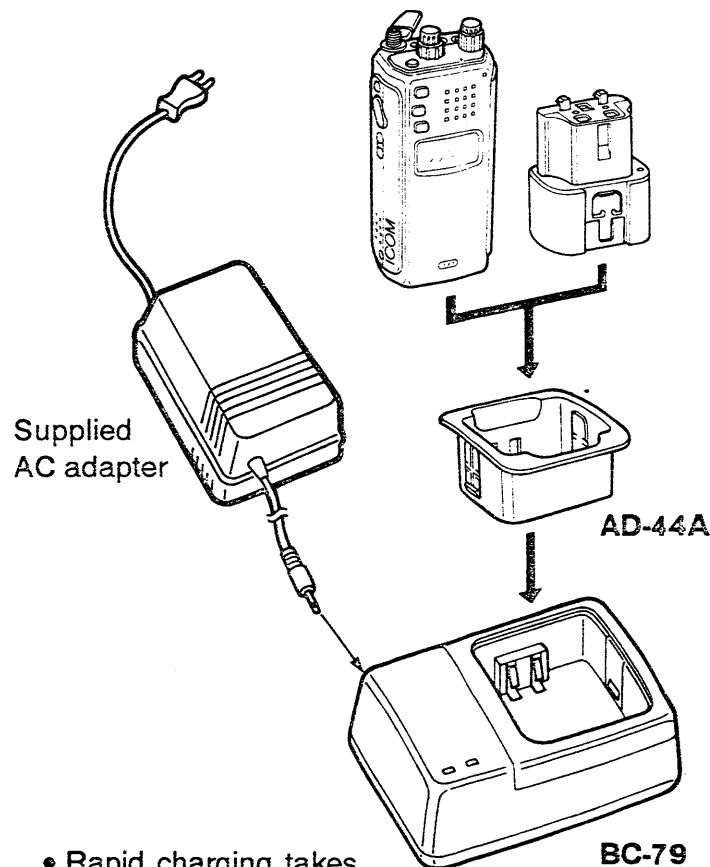

- Rapid charging takes 70–80 min.
- An AC adapter is packed with the BC-79.
- The CP-13/L or OPC-288/L can be used instead of the supplied AC-adaptor.

◇ Speaker-microphones

HM-46

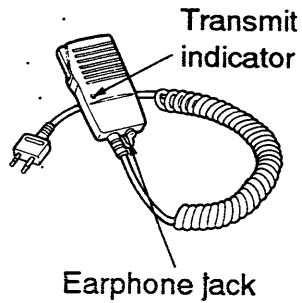

HM-54

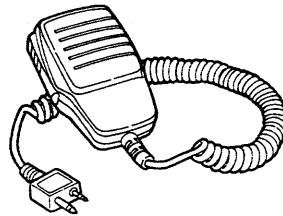

MB-30 MOUNTING BRACKET

When using the bracket hanger

When using no bracket hanger

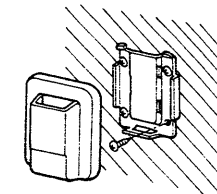
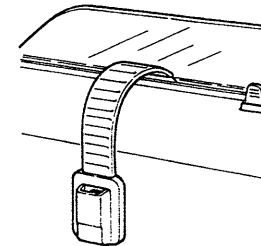

HM-55/A

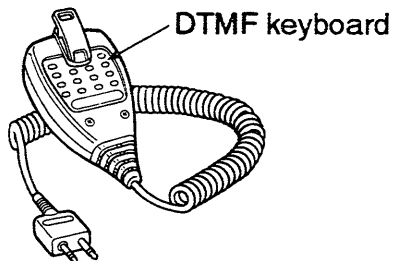

HM-75A

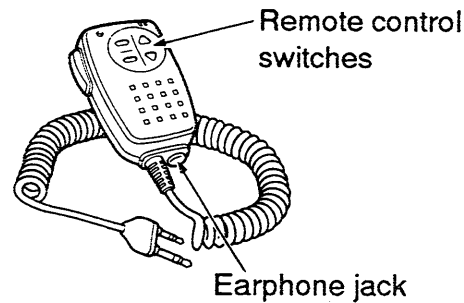

HS-51 HEADSET

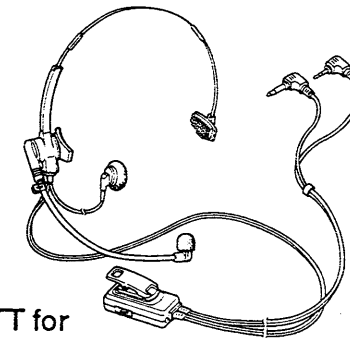

- PTT switch
- VOX
- One-touch PTT for hands-free operation

**SP-13 EARPHONE**

Provides clear receive audio in noisy environments.

**UT-81 TONE SQUELCH UNIT**

Already installed in the U.S.A. version. Provides a "personalized" tone squelch system with other stations and tone scan function. Also functions as a programmable tone encoder.

**Count on us!**

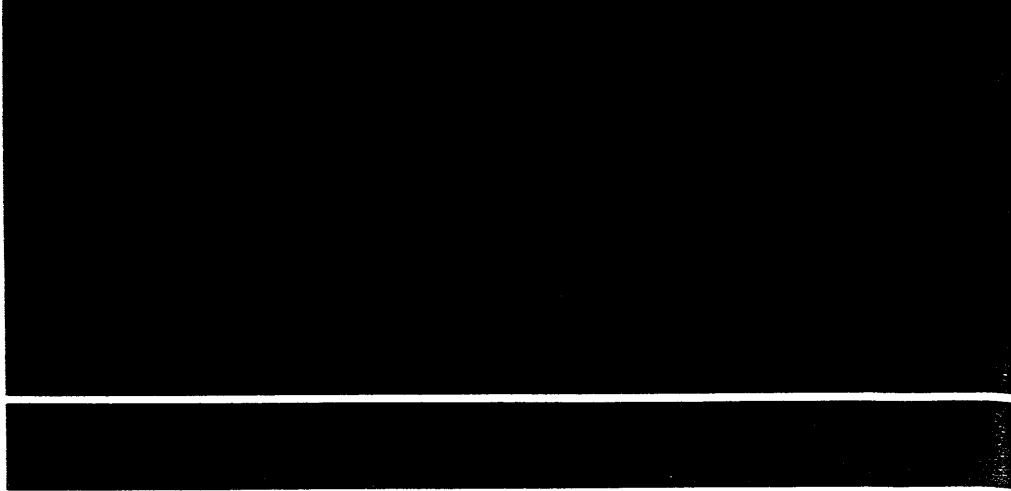

A-5269S-1EX  
Printed in Japan  
Copyright © 1993 by Icom Inc.

---

**Icom Inc.**  
6-9-16, Kamihigashi, Hirano-ku, Osaka 547, Japan

---