



INSTRUCTION MANUAL

VHF TRANSCEIVER
IC-T3H

Downloaded by
RadioAmateur.EU

Icom Inc.

FOREWORD

Thank you for purchasing the IC-T3H FM transceiver. This transceiver is designed for those who require quality, performance and outstanding reliability under the most demanding conditions.

IMPORTANT

READ ALL INSTRUCTIONS carefully and completely before using the transceiver.

SAVE THIS INSTRUCTION MANUAL— This instruction manual contains important operating instructions for the transceiver.

EXPLICIT DEFINITIONS

The explicit definitions below apply to this instruction manual.

WORD	DEFINITION
⚠ WARNING	Personal injury, fire hazard or electric shock may occur.
CAUTION	Equipment damage may occur.
NOTE	If disregarded, inconvenience only. No risk of personal injury, fire or electric shock.

Icom, Icom Inc. and the  ICOM are registered trademarks of Icom Incorporated (Japan) in the United States, the United Kingdom, Germany, France, Spain, Russia and/or other countries.

SUPPLIED ACCESSORIES

Accessories included with the transceiver:

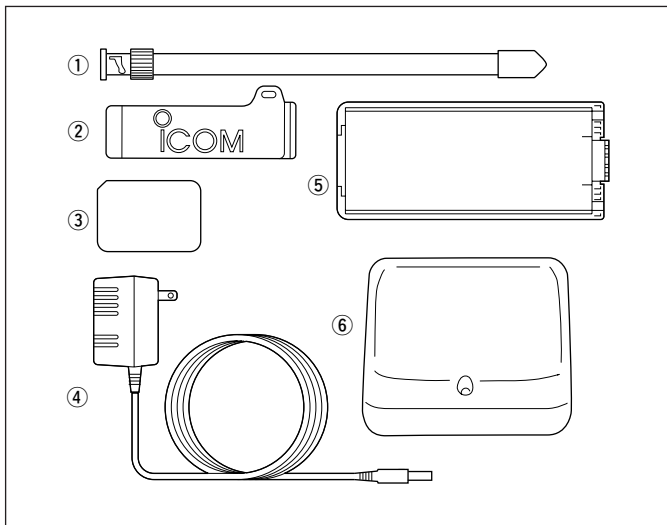

① Antenna	1
② Belt clip	1
③ 2251 OPT sheet	1
④ AC Adapter*	1
⑤ Battery pack*/Battery case*	1
⑥ Battery charging stand*	1

*Not supplied with some versions.

PRECAUTIONS

⚠ WARNING! NEVER hold the transceiver so that the antenna is very close to, or touching exposed parts of the body, especially the face or eyes, while transmitting. The transceiver will perform best if the microphone is 5 to 10 cm away from the lips and the transceiver is vertical.

⚠ WARNING! NEVER operate the transceiver with a headset or other audio accessories at high volume levels. Hearing experts advise against continuous high volume operation. If you experience a ringing in your ears, reduce the volume or discontinue use.

NEVER connect the transceiver to a power source that is DC fused at more than 5 A. Accidental reverse connection will be protected by this fuse, but higher fuse values will not give any protection against such accidents and the transceiver will be ruined.

NEVER attempt to charge alkaline or dry cell batteries. Be aware that external DC power connections will charge batteries inside the battery case. This will damage not only the battery case but also the transceiver.

DO NOT push the PTT when not actually desiring to transmit.

Place the unit in a secure place to avoid inadvertent use by children.

DO NOT operate the transceiver near unshielded electrical blasting caps or in an explosive atmosphere.

AVOID using or placing the transceiver in direct sunlight or in areas with temperatures below -10°C or above $+60^{\circ}\text{C}$.

The use of non-Icom battery packs/chargers may impair transceiver performance and invalidate the warranty.

Even when the transceiver power is OFF, a slight current still flows in the circuits. Remove the battery pack or case from the transceiver when not using it for a long time. Otherwise, the battery pack or installed Ni-Cd batteries will become exhausted.

TABLE OF CONTENTS

FOREWORD	i
IMPORTANT	i
EXPLICIT DEFINITIONS	i
SUPPLIED ACCESSORIES	ii
PRECAUTIONS	iii–iv
TABLE OF CONTENTS	v–vi
1 PANEL DESCRIPTION	1–8
■ Switches, controls, keys and connectors	1–6
■ Function display	7–8
2 ACCESSORIES	9
■ Accessory attachment	9
3 BATTERY PACKS	10–15
■ Battery pack replacement	10
■ Battery caution	11
■ Battery charging	12–13
■ Charging NOTE	14
■ Battery case (optional for some versions)	15
4 BASIC OPERATION	16–20
■ Power ON	16
■ Setting a frequency	16–17
■ Setting audio/squelch level	17
■ Receive and transmit	18
■ Selecting a memory channel	19
■ Selecting the call channel	19
■ Key lock function	19
■ Display type	20
5 REPEATER OPERATION	21–24
■ General	21
■ Offset frequency	22
■ Subaudible tones	22–23
6 MEMORY PROGRAMMING	24–26
■ General	24

■ Programming the memory/call channels	24
■ Channel name programming	25
■ Memory transferring	25–26
7 DTMF MEMORY	27–28
■ Programming a DTMF code	27
■ Transmitting a DTMF code	28
■ DTMF transmission speed	28
8 SCAN OPERATION	29–33
■ Scan types	29
■ Programmed scan	30
■ Memory (skip) scan	31
■ Priority watch	32
■ Scan resume condition	33
9 SUBAUDIBLE TONES	34–37
■ Tone squelch	34–35
■ Pocket beep operation	36
■ Tone scan	37
10 PAGER/CODE SQUELCH	38–44
■ Pager function	38
■ Code programming	39–41
■ Pager operation	42–43
■ Code squelch	44
11 OTHER FUNCTIONS	45–53
■ Set mode	45–47
■ Initial set mode	48–52
■ CPU reset	53
12 CLONING	54
13 OPTIONAL UNIT	55
14 SPECIFICATIONS	56
15 OPTIONS	57–58
16 CE	59–60

1 PANEL DESCRIPTION

■ Switches, controls, keys and connectors

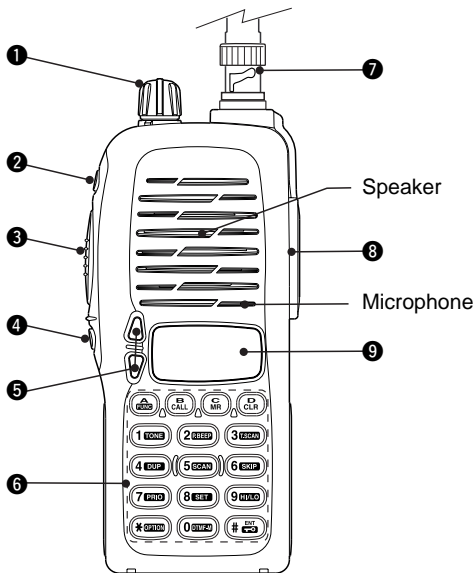

1 CONTROL DIAL [VOL]

A Adjusts the audio level.

B Selects the operating channel or adjusts the squelch level.

- The function **B** is available when [VOL] is assigned as “dial” in INITIAL SET MODE (p. 50).

2 POWER SWITCH [POWER]

Push for 1 sec. to turn the power ON and OFF.

3 PTT SWITCH [PTT]

Push and hold to transmit; release to receive.

4 SQUELCH SWITCH [SQL]

Push and hold to force the squelch open and to adjust the squelch level with [▲]/[▼] keys.

5 UP/DOWN KEYS [▲]/[▼]

A Selects the operating channel or adjusts the squelch level.

B Adjusts the audio level.

- The function **B** is available when [VOL] is assigned as “dial” in INITIAL SET MODE (p. 50).

6 KEY PAD (pgs. 3–6)

Used to enter operating frequency, the DTMF codes, etc.

7 ANTENNA CONNECTOR

Connects the supplied antenna.

8 [SP]/[MIC] JACK

Connect an optional speaker-microphone or headset, if desired. The internal microphone and speaker will not function when either is connected.

◇ **External connection**

NOTE: When connecting or disconnecting an external speaker-microphone, first turn the transceiver's power OFF.

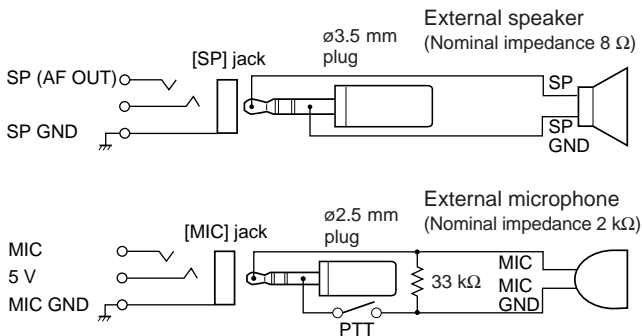







9 FUNCTION DISPLAY (pgs 7, 8)







**Downloaded by
RadioAmateur.EU**

1 PANEL DESCRIPTION

◇ Key pad





KEY [name]	FUNCTION	SECONDARY FUNCTION (After [A•FUNC] is pushed)
 [A•FUNC]	Access to secondary function.	No function.
 [B•CALL]	Select the call channel. (p. 19)	No function.
 [C•MR]	Selects a memory mode. (p. 19)	Entering into memory programming/editing mode. (p. 24) Programs/transfers VFO/memory or call channel contents into memory channel/VFO when pushed for 1 sec. (pgs. 24, 25)
 [D•CLR]	Selects VFO mode, aborts direct frequency input, or cancels scanning, etc. (pgs. 16, 30)	No function.
 [1•TONE]	Input digit "1" during frequency input, memory channel selection, etc. (pgs. 16, 19)	Selects the subaudible tone function. (pgs. 21, 34)
 [2•P.BEEP]	Input digit "2" during frequency input, memory channel selection, etc. (pgs. 16, 19)	Turn the pocket beep function ON and OFF (p. 37)

◇ Key pad (Continued)

KEY [name]	FUNCTION	SECONDARY FUNCTION (After [A•FUNC] is pushed)
 [3•T.SCAN]	Input digit “3” during frequency input, memory channel selection, etc. (pgs. 16, 19)	Starts the tone scanning. (pgs. 23, 37)
 [4•DUP]	Input digit “4” during frequency input, memory channel selection, etc. (pgs. 16, 19)	Selects a duplex function (–duplex, +duplex, simplex). (p. 21)
 [5•SCAN]	Input digit “5” during frequency input, memory channel selection, etc. (pgs. 16, 19)	Starts scanning. (p. 30)
 [6•SKIP]	Input digit “6” during frequency input, memory channel selection, etc. (pgs. 16, 19)	Sets and cancels skip setting for memory skip scan during memory mode. (p. 31)
 [7•PRIO]	Input digit “7” during frequency input, memory channel selection, etc. (pgs. 16, 19)	Starts the priority watch. (p. 32)
 [8•SET]	Input digit “8” during frequency input, memory channel selection, etc. (pgs. 16, 19)	Enters into the SET MODE. (p. 45)

1 PANEL DESCRIPTION

◇ Key pad (Continued)

KEY [name]	FUNCTION	SECONDARY FUNCTION (After [A•FUNC] is pushed)
 [9•HI/LO]	Input digit "9" during frequency input, memory channel selection, etc. (pgs. 16, 19)	Switches between high and low output power. (p. 18)
 [0•DTMF-M]	Input digit "0" during frequency input, memory channel selection, etc. (pgs. 16, 19)	Enters into the DTMF memory mode. (p. 27)
 [*•OPTION]	No function.	Selects an optional pager or code squelch operation mode. (p.38)
 [#•ENT 	Sets the frequency even if the full 6-digits of frequency have not been entered. (p. 16)	Switches key pad lock function ON and OFF when pushed for 1 sec. Lock all keys, except [POWER], [PTT], [SQL] and audio level adjustment. (p. 19)

■ Function display

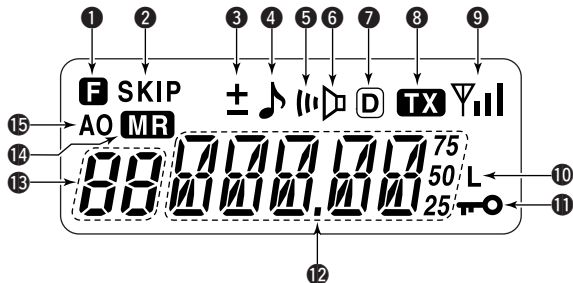

① FUNCTION INDICATOR

Appears while a secondary function is being accessed.

② SKIP CHANNEL INDICATOR

Appears when the selected memory channel is set as a “skip channel.” (p. 31)

③ DUPLEX INDICATOR

Either “-” or “+” appears during repeater operation (p. 21).

④ TONE ENCODER INDICATOR

Appears when tone encoder is in use. (p. 21)

⑤ POCKET BEEP INDICATOR

Appears during pocket beep operation (p. 36).

⑥ TONE SQUELCH INDICATOR

Appears when tone squelch is in use. (p. 34)

⑦ DTCS INDICATOR

Appears when DTCS tone is in use. (p. 34)

⑧ TRANSMIT INDICATOR

Appears during transmit. (p. 18)

1 PANEL DESCRIPTION

■ Function display (continued)

9 SIGNAL INDICATOR

Appears when the channel is busy and shows receiving signal strength as below.



10 LOW POWER INDICATOR

Appears when low output power is selected. (p. 18)

11 KEY LOCK INDICATOR (p. 19)

Appears when the key lock function is ON.

12 FREQUENCY READOUT

Shows operating frequency, channel number or channel names, depending on display mode (p. 20).

13 MEMORY CHANNEL INDICATOR

Indicates the selected memory channel number or other items such as the call channel, etc. (pgs. 19, 24)

14 MEMORY MODE INDICATOR

Appears while in memory mode or channel number indication mode. (p. 24)

15 AUTO POWER OFF INDICATOR

Appears while the auto power OFF function is activated. (p. 49)

■ Accessory attachment

◇ Antenna

Attach the antenna to the transceiver as illustrated at right.

Keep the jack cover attached when jacks are not in use to avoid bad contacts.

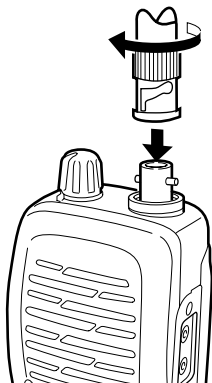

◇ Belt clip

Attach the belt clip to the transceiver as illustrated below.

To attach the belt clip

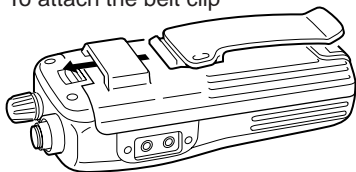

To release the belt clip

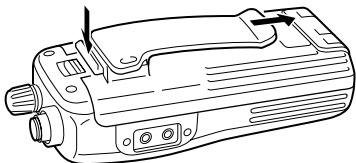

3 BATTERY PACKS

■ Battery pack replacement

Before replacing the battery pack, push [POWER] for 1 sec. to turn the power OFF.

- Slide the battery release forward, then pull the battery pack upward with the transceiver facing away from you.

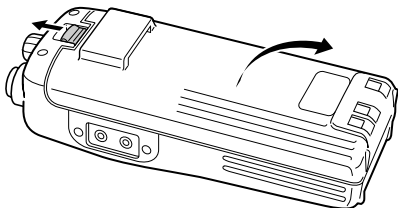

◇ BATTERY PACKS

Battery pack	Voltage	Capacity	Charging period		Battery life*1
			BC-146	BC-144 or BC-121	
BP-208	Battery case for AA (R6)×6 alkaline		N/A	N/A	—*2
BP-209	7.2 V	1100 mAh	12 hrs.	1.5 hrs.	7.5 hrs.
BP-210	7.2 V	1650 mAh	18.5 hrs.	2.0 hrs.	11 hrs
BP-222	7.2 V	600 mAh	6.5 hrs.	1.0 hr.	4 hrs

*1 Operating periods are calculated under the following conditions;

Tx : Rx : standby = 5 : 5 : 90, power save function: auto setting is activated

*2 Operating period depends on the alkaline cells used.

■ Battery caution

- **CAUTION! NEVER** short the terminals of the battery pack (or charging terminals of the transceiver). Also, current may flow into nearby metal objects such as a necklace, so be careful when placing battery packs (or the transceiver) in handbags, etc. Simply carrying with or placing near metal objects such as a necklace, etc. causes shorting. This will damage not only the battery pack, but also the transceiver.
- **NEVER** incinerate used battery packs. Internal battery gas may cause an explosion.
- **NEVER** immerse the battery pack in water. If the battery pack becomes wet, be sure to wipe it dry **BEFORE** attaching it to the transceiver.
- **Clean** the battery terminals to avoid rust or miss contact.
- **Keep** battery contacts clean. It's a good idea to clean battery terminals once a week.

If your battery pack seems to have no capacity even after being charged, completely discharge it by leaving the power ON overnight. Then, fully charge the battery pack again. If the battery pack still does not retain a charge (or only very little charge), a new battery pack must be purchased (p. 57).

3 BATTERY PACKS

■ Battery charging

◇ Regular charging with the BC-146

The optional BC-146 provides regular charging of an optional battery pack with/without transceiver. The following is additionally required:

- An optional AC adapter. (An AD-99 is supplied with BC-146.)

Turn power OFF.

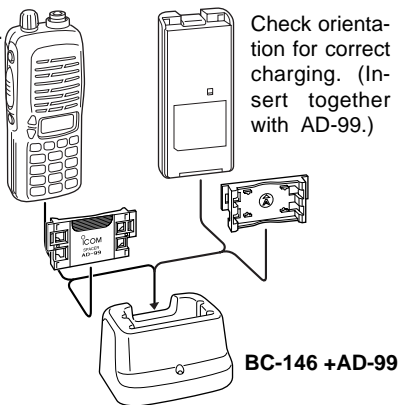

Check orientation for correct charging. (Insert together with AD-99.)

◇ About AD-99

Attach the spacer (Spacer B/C) to the adapter (Spacer A) with orientation as illustrated in the diagram below.

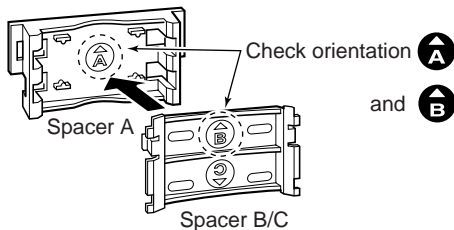

- Attach the spacer (Spacer B/C) to the adapter with the orientation of the stamp “**B**” pointing up.

When removing the spacer (Spacer B/C), push the notch carefully with your finger to remove the spacer (Spacer B/C) from the adapter (Spacer A).

Remove the spacer (Spacer B/C) from the adapter.

Push the notch carefully.

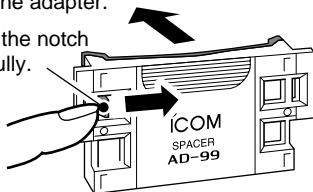

⚠ CAUTION!

DO NOT push or force the notch with a screw driver, etc., to remove it.

DO NOT bend the notch when the adapter and spacer are not joined together. This will cause weakening of the notch plastic.

Both cases may break the notch and it may not be able to be reattached.

3 BATTERY PACKS

◇ Rapid charging with the BC-144

The optional BC-144 provides rapid charging of optional battery packs.

The following are additionally required:

- An AC adapter (may be supplied with the BC-144 depending on version).

Turn power OFF.

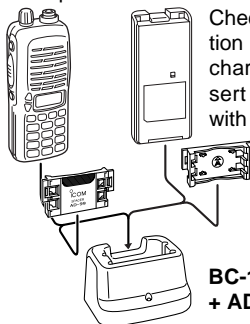

Check orientation for correct charging. (Insert together with AD-99.)

**BC-144
+ AD-99**

◇ Rapid charging with the BC-121+AD-94 (#11)

The optional BC-121 allows up to 6 battery packs to be charged simultaneously. The following are additionally required.

- Six AD-94 (#11).
- An AC adapter (may be supplied with the BC-121 depending on version).

Turn power OFF.

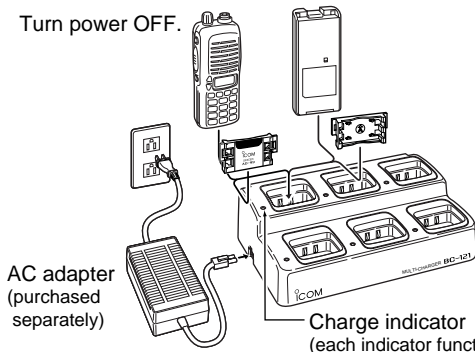

AC adapter
(purchased
separately)

Charge indicator
(each indicator functions independently)

■ Charging NOTE

Prior to using the transceiver for the first time, the battery pack must be fully charged for optimum life and operation.

- Recommended temperature range for charging: +10°C to +40°C
- Use the supplied charger or optional charger (BC-144/BC-121 for rapid charging, BC-146 for regular charging) only. **NEVER** use other manufacturers' chargers.

The optional BP-222, BP-209 or BP-210 battery packs include rechargeable Ni-Cd (Ni-MH: BP-210) batteries and can be charged approx. 300 times. Charge the battery pack before first operating the transceiver or when the battery pack becomes exhausted.

If you want to charge the battery pack more than 300 times, the following points should be observed:

- Avoid over charging. The charging period should be less than 24 hours.
- Use the battery until it becomes almost completely exhausted under normal conditions. We recommend battery charging after transmitting becomes impossible.

◇ Battery pack life

When the operating period becomes extremely short even after charging the battery pack fully, a new battery pack is needed.

3 BATTERY PACKS

■ Battery case (optional for some versions)

When using a BP-208 BATTERY CASE attached to the transceiver, install 6 AA (R6) size alkaline batteries as illustrated below.

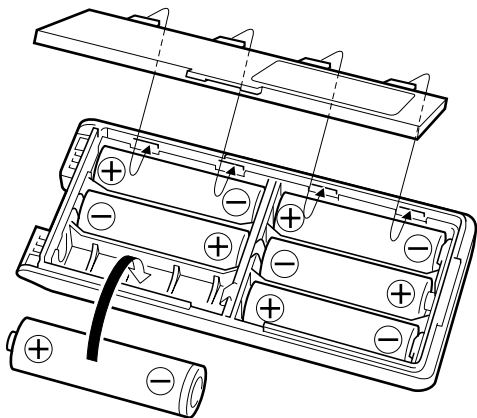

◇ CAUTION

- Use **ALKALINE** batteries only.
- **Make sure** all battery cells are the same brand, type and capacity.
- **Never** mix old and new batteries.
Either of the above may cause a fire hazard or damage the transceiver if ignored.
- **Never** incinerate used battery cells since internal battery gas may cause them to rupture.
- **Never** expose a detached battery case to water.
If the battery case gets wet, be sure to wipe it dry before use.

BASIC OPERATION 4

■ Power ON

Push [POWER] for 1 sec. to turn power ON.

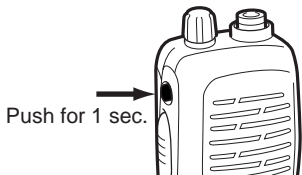

■ Setting a frequency

◇ Via the keypad

- ① Push [D.CLR] to select VFO mode, if necessary.
- ② Enter 6 digit, starting from the 100 MHz digit, to enter the desired frequency.
 - When [#•ENT] is pushed after three or more digits are entered, the frequency is also set.
 - When a digit is mistakenly input, push [D.CLR] to abort inputting.
 - "2" and "7" are acceptable for the 1 kHz digit (depending on the 10 kHz digit).

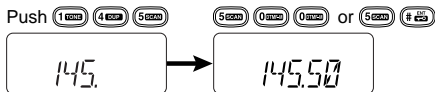

4 BASIC OPERATION

◇ By other methods

Via the [▲]/[▼] keys

Each push increases/decreases the frequency by the selected tuning step.

Using the [VOL]

Rotate the [VOL] to increase/decrease the frequency with the selected tuning step.

- This function is available when “dial” is assigned with [VOL] in INITIAL SET MODE (p. 50).

✓ For your information

Tuning steps:

The transceiver has 8 tuning steps as follows:

5 kHz	10 kHz	12.5 kHz	15 kHz
20 kHz	25 kHz	30 kHz	50 kHz

- A tuning step is selected in SET MODE. (p. 46)

■ Setting audio/squelch level

◇ To set the audio level

Rotate the [VOL] to set the desired audio level while receiving the signal.

- When no signal is received, push and hold [SQL] while setting the audio level.
- When [VOL] is assigned as “dial,” push [▲]/[▼] to adjust the audio output level. (p. 50)

◇ To set the squelch level

While pushing [SQL], push [▲]/[▼] to set the squelch level.

- The squelch level “1” is loose squelch, “10” is tight squelch.
- When [VOL] is assigned as “dial,” rotate [VOL] while [SQL] is pushed. (p. 50)

■ Receive and transmit

- ① Push [POWER] for 1 sec. to turn the power ON.
- ② Adjust volume to the desired level.
- ③ Set a frequency.
When a signal is received:
 - Squelch opens and audio is emitted from the speaker.
 - Signal indicator shows the relative signal strength level.
- ④ Push [9•H/L] after pushing [A•FUNC] to toggle output power between high and low.
 - “L” appears when low output power is selected.
- ⑤ Push and hold [PTT] to transmit, then speak into the microphone.
 - “TX” appears.
 - **Do not** hold the microphone too close to your mouth or speak too loudly. This may distort the signal.
- ⑥ Release [PTT] to receive.

✓ *For your information*

Monitor function:

Push and hold [SQL] to listen to weak signals that do not open the squelch.

4 BASIC OPERATION

■ Selecting a memory channel

- ① Push [C•MR] to select memory mode.
 - “MR” appears.
- ② Enter 2 digits to select the desired memory channel (or push the [▲]/[▼] keys).
 - When [VOL] is assigned as “dial,” rotate [VOL] to select the memory channel. (p. 50)
 - The memory channels 0–9 are preceded by a “0.”

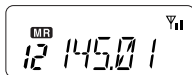
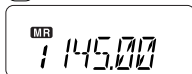

■ Selecting the call channel

- Push [B•CALL] to select the call channel.
- “C” is displayed instead of the memory channel number.
 - Push [D•CLR] or [C•MR] to return to previous indication.

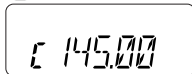

■ Key lock function

The key lock function prevents accidental frequency changes and function activation.

Push [#•ENT ] for 1 sec. after pushing [A•FUNC] to toggle the function ON and OFF.

- “” appears while the lock function is activated.
- [POWER], [PTT], [VOL] and [SQL] can be operated regardless of this setting.

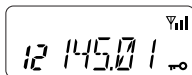

■ Display type

The transceiver has 3 display types to match your operating style. The display type is selected in the INITIAL SET MODE (p. 50).

“Frequency Indication” type is used for basic amateur radio operation.

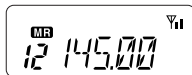

“Channel Indication” type is used to simplify operation. In this mode only pre-programmed memory channel numbers are displayed. VFO mode cannot be selected.

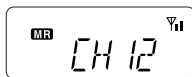

• When the channel indication type is selected, only the following functions can be performed.

- Scan function (p. 29)
- Output power setting (p. 18)
- DTMF memory function (p. 27)
- Key lock function (p. 19)
- Scan pause timer setting, function key timer setting and LCD backlight setting in SET MODE (p. 46)

“Channel Name Indication” type is used to simplify operation the same as above. In this mode pre-programmed memory channel names are displayed.

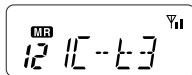

VFO mode selectable.

- Programmed frequency is indicated when the channel name is not pre-programmed in the selected memory channel.
- Push and hold [SQL] to display the operating frequency.

5 REPEATER OPERATION

■ General

When using a repeater, the transmit frequency is shifted from the receive frequency by the offset frequency. It is convenient to program repeater information into memory channels.

- ① Set the receive frequency (repeater output frequency).
- ② Push [4•DUP] after pushing [A•FUNC] several times to select “-” or “+.”
 - “-” indicates the transmit frequency is shifted down; “+” indicates the transmit frequency is shifted up.
 - Flashing “-” or “+” indicates the reversed duplex mode is selected in SET MODE (p. 45).
- ③ Push [1•TONE] after pushing [A•FUNC] to activate the subaudible tone encoder, according to repeater requirements.
 - “♪” appears
 - Select the desired subaudible tone frequency, if necessary. (p. 22)
- ④ Push and hold [PTT] to transmit.
 - The displayed frequency automatically changes to the transmit frequency (repeater input frequency).
 - If “OFF” appears, check the offset frequency and direction.
- ⑤ Release [PTT] to receive.
- ⑥ Push and hold [SQL] to check whether the other station’s transmit signal can be directly received or not.

/// About reversed duplex mode

When the reversed duplex mode is selected, the receive frequency shifts. (Transmit frequency shifts in normal duplex mode.)

Each receive and transmit frequency is shown in the table below with the following conditions;

Inputed freq.: 145.30 MHz

Direction : - (negative)

Offset frequency : 0.6 MHz

	Reversed	OFF	ON
Rx frequency	145.30 MHz	144.70 MHz	
Tx frequency		144.70 MHz	145.30 MHz

■ Offset frequency

USING SET MODE

When communicating through a repeater, the transmit frequency is shifted from the receive frequency by an amount determined by the offset frequency.

- ① Push [**8**•**SET**] after pushing [**A**•**FUNC**] to enter SET MODE.
- ② Push [**▲**]/[**▼**] several times until “±” and offset frequency appear.



±
0.50
- ③ Rotate [VOL] to select the desired offset frequency.
 - Selectable steps are the same as the pre-set tuning steps.
 - The unit of the displayed offset frequency is “MHz.”
- ④ Push [**#**•**ENT** 

■ Subaudible tones

USING SET MODE

Some repeaters require subaudible tones to be accessed. Subaudible tones are superimposed over your normal signal and must be set in advance.

- ① Push [**8**•**SET**] after pushing [**A**•**FUNC**] to enter SET MODE.

rt 00.5
- ② Push [**▲**]/[**▼**] one or more times until “rt” appears.
- ③ Rotate [VOL] to select the desired subaudible tone.
- ④ Push [**#**•**ENT** 

Available subaudible tone frequencies

(unit: Hz)

67.0	79.7	94.8	110.9	131.8	156.7	171.3	186.2	203.5	229.1
69.3	82.5	97.4	114.8	136.5	159.8	173.8	189.9	206.5	233.6
71.9	85.4	100.0	118.8	141.3	162.2	177.3	192.8	210.7	241.8
74.4	88.5	103.5	123.0	146.2	165.5	179.9	196.6	218.1	250.3
77.0	91.5	107.2	127.3	151.4	167.9	183.5	199.5	225.7	254.1

5 REPEATER OPERATION

◇ Tone information

Some repeaters require a tone to be accessed.

DTMF TONES

While pushing [PTT], push the desired DTMF keys (0–9, A–F) to transmit DTMF tones.

- The transceiver has 5 DTMF memory channels (p. 27).

1750 Hz TONE

While pushing [PTT], push [▲] or [▼] to transmit a 1750 Hz tone signal.

✓ *Convenient*

Tone scan function: When you don't know the subaudible tone used for a repeater, the tone scan is convenient for detecting the tone frequency.

Push [3•T.SCAN] after pushing [A•FUNC] to start the tone scan.

- Push [D•CLR] to cancel the scan.
 - When the required tone frequency is detected, the scan pauses.
-

■ General

The transceiver has 100 memory channels (plus 3 pairs of scan edges and 1 call channel) for storage of often-used frequencies.

◇ Memory channel contents

The following information can be programmed into the memory:

- Operating frequency
- Duplex direction (+ or -) with an offset frequency (pgs. 21, 22)
- Subaudible tone encoder or tone squelch ON/OFF (pgs. 21, 34)
- Subaudible tone and tone squelch frequencies (pgs. 22, 35)
- Skip information* (p. 31)

*Except for scan edge channels.

■ Programming the memory/call channels

- ① Push [D•CLR] to select VFO mode, if necessary.
 - ② Set the desired frequency.
 - ③ Set other information such as tone, duplex, etc. as desired.
 - ④ Push [C•MR] for 1 sec. (until 3 beeps are emitted) after pushing [A•FUNC] to program the information into the displayed memory channel and return to VFO
- Continue to hold [C•MR] down for 1 sec. after 3 beeps are emitted, to increment the displayed memory channel number.

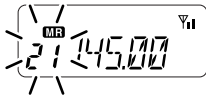

■ Channel name programming

- ① Select a “Channel Name Indication” type in INITIAL SET MODE (p. 50).
- ② Push [C•MR] to select memory mode, if necessary.
- ③ Push [8•SET] after pushing [A•FUNC] to enter into the channel name programming mode.
 - The character to be edited flashes.
- ④ Rotate [VOL] to select a character.
- ⑤ Push [▲] to move to the right, [▼] to move to the left.
 - Up to 5 characters can be used for channel name.
 - Usable characters are; A–Z, 0–9, “space”, +, –, =, *, /, [, and]
- ⑥ Push [#•ENT ] to fix and exit the channel name programming mode.

■ Memory transferring

Memory (call) channel contents can be transferred to the VFO or to another memory channel.

◇ Memory/call \geq VFO

- ① Select the memory (call) channel to be transferred:
 - Push [C•MR] ([B•CALL]) to select memory (call) mode.
 - Push [▲]/[▼] to select the memory channel.
 - When [VOL] is assigned as “dial,” rotate [VOL] to select the memory channel. (p. 50)
- ② Push [C•MR] for 1 sec. after pushing [A•FUNC] to transfer the selected memory contents to the VFO.
 - VFO mode is selected automatically.

◇ Memory/call ➤ call/memory

- ① Select the memory (call) channel to be transferred:
 - Push [C•MR] ([B•CALL]) to select the memory (call) mode.
 - Push [▲]/[▼] to select the memory channel.
 - When [VOL] is assigned as “dial,” rotate [VOL] to select the memory channel. (p. 50)
- ② Push [C•MR] momentarily after pushing [A•FUNC].
 - “--” and “MR” flashes.
- ③ Push [▲]/[▼] to select the target memory.
 - When “dial” is assigned [VOL], rotate [VOL] to select the memory channel. (p. 50)
- ④ Push [C•MR] for 1 sec after pushing [A•FUNC].
 - Memory mode is selected and the contents are transferred to the target memory.





◇ Clearing a memory

- ① Push [C•MR] after pushing [A•FUNC] to enter the memory transfer mode.
 - “MR” and a memory channel number flash.
- ② Push [▲]/[▼] to select the memory channel to be cleared.
 - When [VOL] is assigned as “dial,” rotate [VOL] to select the memory channel. (p. 50)
 - The call channel cannot be cleared.
- ③ Push [C•MR] after pushing [A•FUNC] momentarily, then push [C•MR] for 1 sec after pushing [A•FUNC] again.
 - Perform this operation within 1.5 sec, otherwise the memory clearing is cancelled and the transceiver returns to the memory mode.
 - The contents of the selected memory are cleared.
- ④ Push [D•CLR] to return to regular operation.

7 DTMF MEMORY

■ Programming a DTMF code

The transceiver has 5 DTMF memory channels (d0 to d4) for storage of often-used DTMF codes of up to 24 digits.

- ① Push [0•DTMF-M] after pushing [A•FUNC] to enter the DTMF memory.
 - One of “d0” to “d4” appears.
- ② Rotate [VOL] to select the desired channel.
- ③ Push [0•DTMF-M] for 1 sec. after pushing [A•FUNC] to enter the DTMF programming mode.
 - “_____” appears.
 - Programmed memories can be cleared in this way.
- ④ Push the digit keys, [A•FUNC], [B•CALL], [C•MR], [D•CLR], [X•OPTION] and [#•ENT ] to enter the desired DTMF code.
 - A maximum of 24 digits can be input.
 - [X•OPTION] enters as “E”, [#•ENT ] enters as “F.”
 - If a digit is mistakenly input, push [SQL] or [PTT] momentarily then repeat from step ①.
- ⑤ Push [SQL] or [PTT] to input the digits and exit the DTMF programming mode.
 - Programmed DTMF codes sound when [SQL] is pushed to exit.

■ Transmitting a DTMF code

◇ Using a DTMF memory channel

- ① Push [0•DTMF-M] after pushing [A•FUNC] to enter the DTMF memory.
- ② Rotate [VOL] to select the desired channel.
- ③ Push [SQL] or [PTT] to exit the DTMF memory mode.
- ④ While pushing [PTT], push [SQL] to transmit the selected DTMF memory.
 - After the DTMF code is transmitted, the transceiver returns to receive automatically.

◇ Manual DTMF code transmission

While pushing [PTT], push digit keys, A–F to transmit a DTMF code manually.

■ DTMF

USING INITIAL SET MODE

transmission speed

When slow DTMF transmission speeds are required with DTMF memory transmission (as for some repeaters), the transceiver's rate of DTMF transmission can be adjusted.

- ① While pushing [▲] and [▼], turn the power on to enter INITIAL SET MODE.
- ② Push [▲]/[▼] several times until “dtd” appears.
- ③ Rotate [VOL] to select the desired DTMF transmission speed.
 - Four speeds are available: “1” (100 msec. intervals) is the fastest; “5” (500 msec. intervals) is the slowest.
- ④ Push [#•ENT 

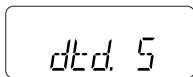
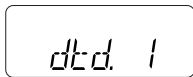

8 SCAN OPERATION

Scan types

PROGRAMMED SCAN

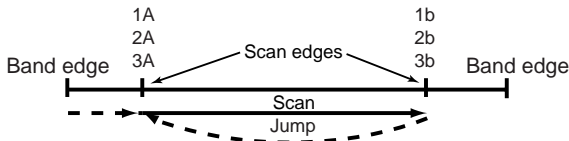

MEMORY (SKIP) SCAN

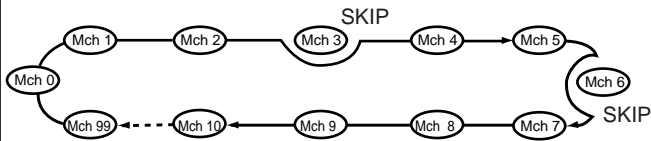

PRIORITY WATCH

Priority memory channel watch

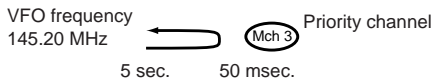

Priority memory channel scan

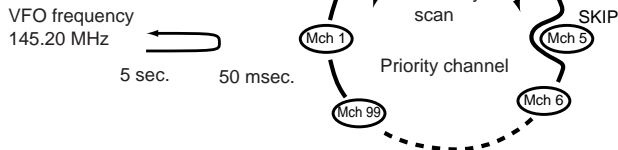

■ Programmed scan

Programmed scan repeatedly scans between two user programmed frequencies (memory channels “1A–3A” and “1b–3b”) or scans between upper and lower band edges. This scan is useful for checking for signals within a specific frequency range such as repeater output frequencies, etc.

- ① Push [D•CLR] to select VFO mode, if necessary.
- ② Push [5•SCAN] after pushing [A•FUNC] to start the scan, then a selected scan edge appears as “P1”, “P2”, “P3” or “AL.”
 - To change the scan edge, push [8•SET] after pushing [A•FUNC] several times until the desired scan edge appears.
 - “AL” for full scan, “P1”, “P2” and “P3” for programmed scan between the programmed scan edge channels as “1A”–“1b”, “2A”–“2b” and “3A”–“3b”.
 - To change the scan direction, push [▲] or [▼].
 - When “dial” is assigned [VOL], rotate [VOL] to change the scan direction. (p. 50)
- ③ Push [D•CLR] to stop the scan.

NOTE: Scan edges, 1A–3A/1b–3b, must be programmed in advance. Program them in the same manner as regular memory channels. (p. 24)
 If the same frequencies are programmed into the scan edges, programmed scan will not proceed.

■ Memory (skip) scan

Memory scan repeatedly scans all programmed memory channels, except those set as *skip* channels.

- ① Push [C•MR] to select memory mode, if necessary.
 - “MR” appears.
- ② Push [5•SCAN] after pushing [A•FUNC] to start the scan.
 - To change the scan direction, push [▲] or [▼].
 - When “dial” is assigned [VOL], rotate [VOL] to change the scan direction. (p. 50)
- ③ Push [D•CLR] to stop the scan.

◇ Setting skip channels

In order to speed up the scan interval, you can set memory channels you don't wish to scan as skip channels.

- ① Push [C•MR] to select memory mode, if necessary.
 - “MR” appears.
- ② Select a memory channel to set as a skip channel.
- ③ Push [6•SKIP] after pushing [A•FUNC] to toggle the skip setting ON and OFF.
 - “SKIP” appears when the channel is set as a skip channel.

■ Priority watch

Priority watch checks for signals on “priority channels” while operating on a VFO frequency.

◇ Memory or call channel watch

While operating on a VFO frequency, memory or call channel watch monitors for signals in the selected memory or call channel every 5 sec.

- ① Select the desired memory channel or the call channel.
- ② Push [D•CLR] to select VFO mode.
- ③ Push [7•PRIO] after pushing [A•FUNC] to start watching.
 - VFO is displayed, then the decimal point “.”, on the frequency read-out flashes.
 - The priority channel is monitored every 5 sec.
 - When the signal is detected on the priority channel, the watching is paused according to the setting of the scan resume condition.
- ④ Push [D•CLR] to stop watching.

◇ Memory scan watch

While operating on a VFO frequency or the call channel, memory scan watch monitors for signals in each memory channel in sequence, every 5 sec.

- ① Push [C•MR] to select memory mode, if necessary.
 - “MR” appears.
- ② Push [5•SCAN] after pushing [A•FUNC] to start the memory scan.
- ③ Push [7•PRIO] after pushing [A•FUNC] to start the watching.
 - VFO is displayed, then the decimal point “.”, on the frequency read-out flashes.
 - When the signal is detected on the priority channel, the watching is paused according to the setting of the scan resume condition.
- ④ Push [D•CLR] to stop the watching.

■ Scan resume condition USING SET MODE

When a signal is received during scanning, the scan resume condition determines what action the transceiver takes. The transceiver has 2 scan resume conditions available as illustrated at right. Use SET MODE to select the one which best suits your needs.

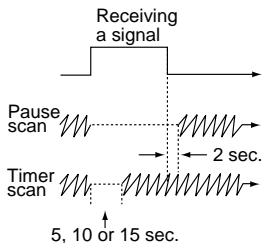

- ① Push [8•SET] after pushing [A•FUNC] to enter SET MODE.
- ② Push [▲]/[▼] several times until "SCP" or "SCt" appears.
- ③ Rotate [VOL] to select the desired scan resume condition.

- *Pause scan*: When receiving a signal, scan pauses on the signal until it disappears. Resumes 2 sec. after the signal disappears.

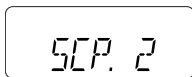

Pause scan

- *Timer scan*: When receiving a signal, scan pauses on the signal for 5 sec., 10 sec. or 15 sec., then resumes.

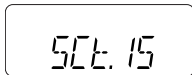

Timer scan

- ④ Push [#•ENT ] to set and exit SET MODE.

**Downloaded by
RadioAmateur.EU**

■ Tone squelch

◇ Operation

The tone squelch opens only when receiving a signal containing a matching subaudible tone. You can silently wait for calls from group members using the same tone.

- ① Set the operating frequency.
 - Set the AF and squelch to the desired level as the normal operation.
- ② Set the desired subaudible tone in the set mode.
 - See right for programming.
- ③ Push [1•TONE] after [A•FUNC] is pushed.
 - Repeat several times until “▷” appears when selecting CTCSS, or “Ⓢ” appears when selecting DTCS.
- ④ When the received signal includes a matching tone, squelch opens and the signal can be heard.
 - When the received signal’s tone does not match, tone squelch does not open, however, the S-indicator shows signal strength.
 - To open the squelch manually, push and hold [SQL].
- ⑤ Operate the transceiver in the normal way.
- ⑥ To cancel the tone squelch, push [1•TONE] after [A•FUNC] is pushed.
 - Repeat several times until “▷” or “Ⓢ” disappears.

NOTE: The transceiver has 50 tone frequencies and consequently their spacing is narrow compared to units having 38 tones. Therefore, some tone frequencies may receive interference from adjacent tone frequencies.

To prevent interference from adjacent tone frequencies, using the frequencies as in the following table, is recommended.

• Recommended tone frequencies

67.0	77.0	88.5	100.0	114.8	131.8	151.4	173.8	203.5	233.6
69.3	79.7	91.5	103.5	118.8	136.5	156.7	179.9	210.7	241.8
71.9	82.5	94.8	107.2	123.0	141.3	162.2	186.2	218.1	250.3
74.4	85.4	97.4	110.9	127.3	146.2	167.9	192.8	225.7	

9 SUBAUDIBLE TONES

◇ Setting subaudible tones for tone squelch operation

Separate tone frequencies can be set for tone squelch operation rather than repeater operation (the same range of tones is available— see below). Like the repeater tones, these are set in set mode.

- ① Select VFO or memory channel.
- ② Push [A•FUNC] + [8•SET] to enter set mode.
- ③ Push [▲] or [▼] several times until “Ct” appears when selecting CTCSS, or “dt” appears when selecting DTCS.
 - “▷” flashes when selecting CTCSS, or “@” flashes when selecting DTCS.

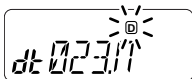

- ④ Rotate [VOL] to select the desired subaudible tone.
- ⑤ Push [#•ENT 

When SET MODE is selected from memory mode.

- ⑥ Push [C•MR] for 1 sec. after [A•FUNC] is pushed.
 - 3 beeps are emitted.
 - VFO mode is selected automatically.
- ⑦ Push [C•MR] for 1 sec. after [A•FUNC] is pushed.
 - 3 beeps are emitted.

Steps ⑥ and ⑦ are necessary when overwriting the memory contents permanently. The set tone frequency is used for temporary operation only, therefore, these steps are not necessary.

• Available CTCSS tone frequency list

67.0	79.7	94.8	110.9	131.8	156.7	171.3	186.2	203.5	229.1
69.3	82.5	97.4	114.8	136.5	159.8	173.8	189.9	206.5	233.6
71.9	85.4	100.0	118.8	141.3	162.2	177.3	192.8	210.7	241.8
74.4	88.5	103.5	123.0	146.2	165.5	179.9	196.6	218.1	250.3
77.0	91.5	107.2	127.3	151.4	167.9	183.5	199.5	225.7	254.1

■ Pocket beep operation

This function uses subaudible tones for calling and can be used as a “common pager” to inform you that someone has called when you were away from the transceiver.

◇ Waiting for a call from a specific station

- ① Set the operating frequency.
- ② Set the desired CTCSS tone frequency or DTCS code in the set mode.
 - See p. 35 for programming details.
- ③ Push [1•TONE] after [A•FUNC] is pushed.
 - Repeat several times until “▷” appears when CTCSS, or “Ⓜ” appears when DTCS is selected.
- ④ Push [2•P.BEEP] after [A•FUNC] is pushed to activate the pocket beep function.
 - “Ⓜ” appears.
- ⑤ When a signal with the matched tone is received, the transceiver emits beep tones and flashes “Ⓜ.”
 - Beep tones sound for 30 sec. and “Ⓜ” flashes. To stop the beeps manually, push any key. “Ⓜ” continues flashing until step ⑥ is operated.
- ⑥ Push [PTT] to answer.
 - “Ⓜ” disappears and cancels the pocket beep function automatically.

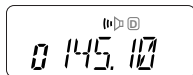

“Ⓜ” appears

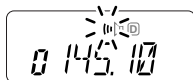

9 SUBAUDIBLE TONES

■ Tone scan

By monitoring a signal that is being operated with a repeater, pocket beep or tone squelch function, you can determine the tone frequency necessary to access a repeater or open the squelch.

- ① Set the frequency to be checked for a tone frequency or code.
- ② Push [1•TONE] after [A•FUNC] is pushed.
 - Repeat several times to select the tone condition or type to be scanned. (One of “♪”, “▷” or “Ⓚ” appears)
 - The tone scan can be operated even if the tone condition or type is not selected.
- ③ Push [3•T.SCAN] after [A•FUNC] is pushed to start the tone scan.
 - To change the scanning direction, push [▲] or [▼].
- ④ When the CTCSS tone frequency or DTCS code is matched, the squelch opens and the tone frequency or code is temporarily programmed into the selected mode such as memory or call channel.
 - The tone scan pauses when a CTCSS tone frequency or 3-digit DTCS code is detected.
 - The decoded CTCSS tone frequency or 3-digit DTCS code is used for the tone encoder or tone encoder/decoder depending on the selected tone condition or type in step ②.
 - No indication : Cannot be used for operation.
 - “♪” : CTCSS tone encoder
 - “▷” : CTCSS tone encoder/decoder
 - “Ⓚ” : DTCS tone encoder/decoder
- ⑤ Push [D•CLR] to stop the scan.

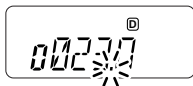

PAGER/CODE SQUELCH 10

■ Pager function

Optional UT-108 required

This function uses DTMF codes for paging and can be used as a "message pager" to confirm you of a caller's identification even when you leave the transceiver temporarily unattended.

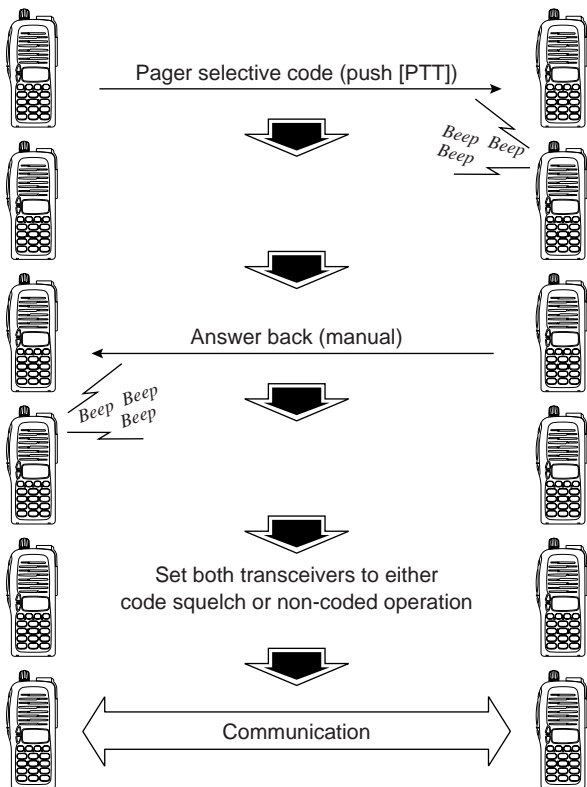

■ Code programming *Optional UT-108 required*

◇ Before programming

The pager and code squelch functions require ID codes and a group code. These codes are 3-digit DTMF codes and must be written into the code channels before operation.

- ① Decide the ID code of each transceiver and a group code for your group.
- ② Decide whether you want to return to normal operation or code squelch operation after a connection is made.
- ③ Program the ID code, group code and transmit codes (other station's codes) as below.

◇ Code channel assignment

ID OR GROUP CODE	CODE CHANNEL NUMBER	"RECEIVE ACCEPT" OR "RECEIVE INHIBIT"
Your ID code	0	"Receive accept" only
Other parties' ID code	1-6	"Receive inhibit" should be programmed in each channel.
Group code	One of 1-6	"Receive accept" must be programmed.
Memory space*	P	"Receive inhibit" only.

*Channel CP automatically memorizes an ID code when receiving a pager call. The contents in channel CP cannot be changed manually.

◆ Code programming

An ID code **MUST** be programmed into code channel C0. Up to 6 transmit codes are programmable into code channels, C1 to C6, if required.

- ① Push [**★•OPTION**] after [**A•FUNC**] is pushed.

- Pager mode is selected.
- 100 MHz digit shows "P."

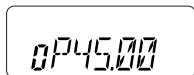

- ② Push [**8•SET**] after [**A•FUNC**] is pushed.

- One of either "CP" or "C0" to "C6" flashes.
- "C0" is the ID code and "C1" to "C6" are transmit codes.

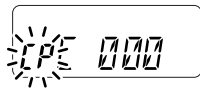

- ③ Rotate [**VOL**] to select code channel C0.

- A different ID code must be programmed into each transceiver.

- ④ Enter the desired 3-digit ID code via the keypad.

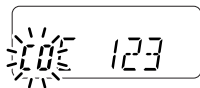

- ⑤ Rotate [**VOL**] to select a transmit code channel from C1 to C6.

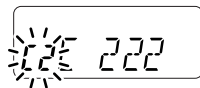

- ⑥ Enter the desired 3-digit transmit code via the keypad.

- ⑦ Push [**6•SKIP**] after [**A•FUNC**] is pushed to set the channel for "receive inhibit" or "receive accept."

- When "receive inhibit" is set, "SKIP" appears as at right.
- Code channel C0 cannot be set as "receive inhibit."
- See the table for "receive accept" and "receive inhibit" details (p. 42).

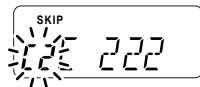

- ⑧ Repeat steps ⑤ and ⑥ to set additional transmit code channels, if desired.

- ⑨ Push [**#•ENT** ] or [**PTT**] to exit code set mode.

10 PAGER/CODE SQUELCH

• **Receive accept/receive inhibit**

- ↳ “Receive accept” (“SKIP” indicator does not appear) accepts pager calls when the transceiver receives a signal with a code the same as that in the code channel.
- ↳ “Receive inhibit” (“SKIP” indicator appears) rejects calls even when the transceiver receives a code the same as that in the code channel. Transmit codes should therefore be programmed for “receive inhibit,” otherwise the transceiver will not reject unnecessary calls.

• **Pager/code squelch operation during channel indication**

To use these functions in channel indication, the pager/code squelch setting must be programmed with other memory contents before selecting channel number indication.

■ Pager operation

Optional UT-108 required

◇ Calling a specific station

- ① Program the desired code channel in advance (p. 40).
 - ② Set the operating frequency.
 - Set the AF and squelch to the desired level as in normal operation.
 - ③ Push [**★•OPTION**] after [**A•FUNC**] is pushed.
 - Pager mode is selected.
 - 100 MHz digit shows "P."
-
- ④ Select the desired transmit code channel:
 - ➔ Push [**8•SET**] after [**A•FUNC**] is pushed.
 - ➔ Rotate [**VOL**] to select the desired code channel.
 - ➔ Push [**#•ENT** 
 - ⑤ Push [**PTT**] to transmit the pager code.
 - ⑥ Wait for an answer back.
 - When the transceiver receives an answer back code, the function display shows the other member's ID or group code.
 - ⑦ After confirming a connection push [**★•OPTION**] after [**A•FUNC**] is pushed to select the code squelch operation, or repeat the previous key operation again to select non-selective calling system.
 - DO NOT push any digit keys while code channels C0 to C6 are displayed, or code channel contents will be changed.
 - ⑧ Communicate with the other party as normal: push [**PTT**] to transmit; release to receive.

10 PAGER/CODE SQUELCH

◇ Waiting for a call from a specific station

- ① Set the operating frequency.
- ② Push [**★•OPTION**] after [**A•FUNC**] is pushed.
 - 100 MHz digit shows "P."
- ③ Wait for a call.
 - When receiving a call, the caller's ID or group code appears as shown below.
 - DO NOT push any digit keys while code channels C0 to C6 are displayed, or code channel contents will be changed.
- ④ Push [**PTT**] to send an answer back call and display the operating frequency.
- ⑤ After confirming a connection push [**★•OPTION**] after [**A•FUNC**] is pushed to select code squelch operation, or repeat previous key operation again to select non-selective calling system.

• PERSONAL CALLS

This display appears when you are called with your ID code and the calling station's ID code is 123.



CP and  flash.

• GROUP CALLS

This display appears when you are called with the group code, 888, and 888 has been programmed into code channel C6.

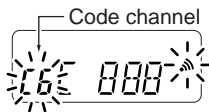

• ERROR INFORMATION

When the transceiver receives an incomplete signal, "E" and previously received code appear.

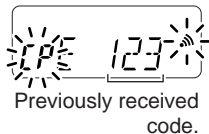

Previously received code.

■ Code squelch

Optional UT-108 required

Code squelch provides communications with quiet standby since you will only receive calls from stations which know your ID or group code. Each push of [PTT] sends a 3-digit code in order to open the receiving station's code squelch prior to voice transmission.

- ① Set the operating frequency.
 - Set the AF and squelch to the desired level as in normal operation.
 - ② Push [**★•OPTION**] after [**A•FUNC**] is pushed.
 - Repeat several times, if necessary.
 - Code squelch mode is selected.
 - 100 MHz digit shows "C."
-
- ③ Select the desired transmit code channel:
 - ➔ Push [**8•SET**] after [**A•FUNC**] is pushed.
 - ➔ Rotate [VOL] to select the desired code channel.
 - ➔ Push [**#•ENT** **TO**] to exit code set mode.
 - ④ Operate the transceiver in the normal way (push [PTT] to transmit; release [PTT] to receive).
 - ⑤ To cancel the code squelch, push [**★•OPTION**] after [**A•FUNC**] is pushed.
 - 100 MHz digit shows "1" when the function is cancelled.

11 OTHER FUNCTIONS

■ Set mode

◇ Entering set mode

- ① Push [8•SET] after [A•FUNC] is pushed.
- ② Push [▲] or [▼] to select the desired item.
- ③ Rotate [VOL] to select the condition/value.
 - To exit set mode, push [#•ENT ].

◇ Repeater tone frequency

Selects tone encoder frequency for accessing a repeater, etc. from one of 50 available frequencies.

- 67.0–254.1 Hz (50 tones): 88.5 Hz (default)



◇ Tone squelch frequency

Selects frequency for tone squelch or pocket beep operation from one of 50 available frequencies.

- 67.0–254.1 Hz (50 tones): 88.5 Hz (default)



◇ DTCS code

Selects DTCS encoder/decoder code with polarity (N: normal/I: inverse) from one of 208 available codes.

- 023N/I–754N/I: 023N (default)

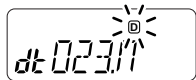

◇ Offset frequency

Sets the offset frequency for duplex (repeater) operation within 0–20.00 MHz range.

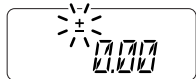

◇ Reverse function

Turns the reverse function ON and OFF.

- Default: OFF

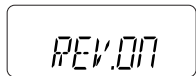

◇ Tuning step

Selects tuning step from 5, 10, 12.5, 15, 20, 25, 30 and 50 kHz.

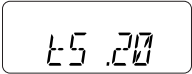
◇ Scan pause timer

Selects the scan pause time from SCt.5, SCt.10, SCt.15 and SCP. 2. When receiving signals, the scan pauses according to the scan pause time.



- SCt. 5/10/15 : Scan pauses for 5/10/15 sec. (default: SCt.15)



- SCP. 2 : Scan pauses until the signal disappears. Resumes 2 sec. after the signal appears.

◇ Function key timer

Selects [A•FUNC] effect timer from F0.At, F1.At, F2.At, F3.At and F .m.



- F0.At : "■" disappears immediately after secondary function is operated. (default)



- F1/2/3.At : "■" disappears after 1/2/3 sec. after secondary function is operated.

- F .m : "■" appears until [A•FUNC] is pushed again.

◇ LCD backlight

Selects LCD backlight lighting condition from auto, ON and OFF.



- LIG.At : Lights when any key except [PTT] is pushed. (default)

- LIG.ON : Lights continuously while the transceiver is powered ON.

- LIG.OF : Never lights.

11 OTHER FUNCTIONS

◆ Transmission permission

Turns transmission permission ON and OFF. This function can be set for each memory and call channel, independently.

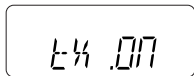

- tX .ON: Transmission is permitted. (default)
- tX .OF : Transmission is inhibited.

◆ Pager/Code squelch channel

Optional UT-108 required

Programs 3-digit ID code in channel "C0" and individual or group call code in channel "C1" to "C6" for the pager and code squelch functions. See p. 41 for programming details.

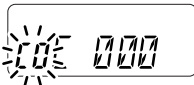

*This item appears only when the optional UT-108 is installed and pager or code squelch function is activated.

■ Initial set mode

AT POWER ON

The initial set mode is accessed at power on and allows you to set seldom-changed settings. In this way, you can “customize” transceiver operations to suit your preference and operating style.

◇ Entering initial set mode

- ① Turn power on while [▲] and [▼] are pushed.
- ② Push [▲] or [▼] to select the desired item.
- ③ Rotate [VOL] to select the condition/value.
 - To exit set mode, push [#•ENT ].

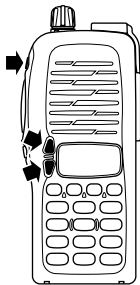

◇ Key-touch beep

Turns key-touch beep emission ON and OFF.

- Default: ON

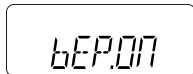

◇ Time-out timer

To prevent accidental prolonged transmission, etc., the transceiver has a time-out timer. This function cuts a transmission OFF after 1–30 min. of continuous transmission. This timer can be cancelled.



- tOt.OF : The time-out timer is turned OFF. (default)
- tOt. 1–30 : The transmission is cut OFF after the set period elapses.

11 OTHER FUNCTIONS

◆ Auto power-off

The transceiver can be set to automatically turn OFF after a specified period with a beep when no key operations are performed.

- 30 min., 1 hour, 2 hours and OFF (default) can be specified. The specified period is retained even when the transceiver is turned OFF by the auto power-off function. To cancel the function, select "POF.OF" in this set mode.



POF.OF

AO

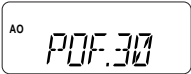

POF.30

◆ Repeater lock-out

Selects lockout type from repeater, busy and OFF.

- RLO.RP : The repeater lockout is turned ON.
- RLO.bu : The busy lockout is turned ON.
- RLO.OF : No lockout is activated. (default)



RLO.OF

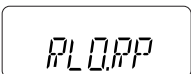

RLO.RP

◆ Squelch delay

Selects squelch delay from short and long to prevent repeated opening and closing of the squelch during reception of the same signal.

- Sqt. S: The squelch closes in short delay. (default)
- Sqt. L: The squelch closes in long delay.

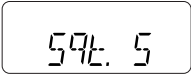

Sqt. S

◆ DTMF speed

The rate at which DTMF memories send individual DTMF characters can be set to accommodate operating needs.

- 1: 100 msec. interval; 5.0 cps speed (default)
- 2: 200 msec. interval; 2.5 cps speed
- 3: 300 msec. interval; 1.6 cps speed
- 5: 500 msec. interval; 1.0 cps speed



dtc. 1

(cps=characters/sec.)

◆ Dial assignment

Selects [VOL] control action from AF volume and tuning dial.

- tOP.VO : AF volume (default)
- tOP.dl : Tuning dial

tOP.VO

tOP.dl

◆ Display type

Selects LCD indication type from frequency, channel number and channel names.

- dSP.FR : Shows frequency (default)
 - dSP.CH : Shows channel number*
 - dSP.Nm : Shows channel names
- *Memory channels only can be selected.

dSP.FR

dSP.CH

dSP.Nm

◆ LCD contrast

Selects LCD contrast from auto and low.

- LCd.AT : Automatic (default)
- LCd.LO : Low contrast

LCd.AT

◆ Power save

Selects duty cycle for power save function from auto, 1:32, 1:16, 1:8, 1:2 and OFF.

- P-S.At : Duty cycle changes automatically. (default)
- P-S.32 : 1:32 duty cycle
- P-S.16 : 1:16 duty cycle
- P-S. 8 : 1:8 duty cycle
- P-S. 2 : 1:2 duty cycle
- P-S.OF : The power save function is turned OFF.

P-S.At

P-S.32

11 OTHER FUNCTIONS

◇ Tuning speed acceleration

The tuning speed acceleration automatically speeds up the tuning speed when pushing and holding [▲] or [▼], or rotating [VOL] rapidly.*

- S-S.At : The tuning speed acceleration is activated. (default)
- S-S. m : The tuning speed acceleration is not activated.

*When tuning dial is assigned with [VOL].

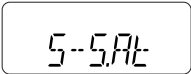
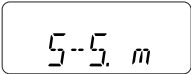
A rectangular LCD display showing the text "S-S.At" in a digital font.A rectangular LCD display showing the text "S-S. m" in a digital font.

Optional HM-75A required**◇ Mic simple mode**

This item turns the microphone simple mode ON and OFF. Microphone simple mode is used to change the function assignments for keys in the optional HM-75A REMOTE CONTROL SPEAKER-MICROPHONE as below. This assignment is convenient for 3-channel use of simple operation.

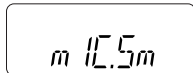
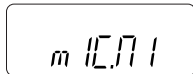

- m1C.N1 : Normal 1 (default)
- m1C.N2 : Normal 2
- m1C.Sm : Simple mode

HM-75A key	Mode	NORMAL1	NORMAL2	SIMPLE
[A]	Freq. CH	[B•CALL] Null	[SQL]	[SQL]
[B]	Freq. CH	VFO/Memory Null	VFO/Memory Null	[B•CALL]
[▲]	Freq. CH	Freq. Up Memory CH Up	Freq. Up Memory CH Up	MR-00CH
[▼]	Freq. CH	Freq. Down Memory CH Down	Freq. Down Memory CH Down	MR-01CH

A 1750 Hz tone can be transmitted with the HM-75A operation.

➡ Push [A] while pushing [PTT].

NOTE:

Turn power OFF when connecting the HM-75A to the transceiver.

VFO mode cannot be selected via the microphone when SIMPLE mode is selected.

■ CPU reset

AT POWER ON

The function display may occasionally display erroneous information (e.g. when first applying power). This may be caused externally by static electricity or other factors.

If this problem occurs, turn power OFF. After waiting a few seconds, turn power ON again. If the problem persists, perform CPU resetting operation as follows.

- Turn power ON while [SQL] and [D•CLR] are pushed.

CAUTION:

Resetting the CPU returns all programmed contents to their default settings.

Downloaded by
RadioAmateur.EU

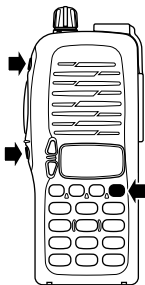

CLONING 12

Cloning allows you to quickly and easily transfer the programmed contents from one transceiver to another transceiver.

◇ **Transceiver-to-transceiver cloning** AT POWER ON

- ① Connect the OPC-474 CLONING CABLE to the [SP] jack of the master and sub-transceivers.
 - The master transceiver is used to send data to the sub-transceiver.
- ② While pushing [A•FUNC] + [▲], turn power ON to enter cloning mode (master transceiver only— power ON only for sub-transceiver).
 - “CLONE” appears and the transceivers enter the clone standby condition.
- ③ Push [PTT] on the master transceiver.
 - “CL” appears in the master transceiver’s display and two digit numbers show that data is being transferred to the sub-transceiver.
 - “CL IN” appears automatically in the sub-transceiver’s display and two digit numbers show that data is being received from the master transceiver.
- ④ When cloning is finished, turn power OFF, then ON again to exit cloning mode.

 **NOTE:** DO NOT push the [PTT] on the sub-transceiver during cloning. This will cause a cloning error.

13 OPTIONAL UNIT

◇ Optional UT-108 installation

- ① Remove the optional connector access cover (named 2251 OPT sheet).

- Insert a screwdriver into the hollow of the chassis, then lift and take away the cover. (The cover cannot be used again.)

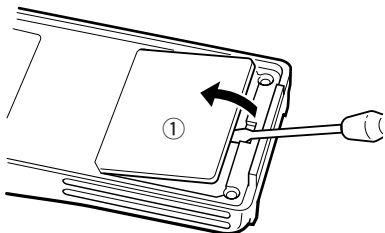

WARNING!

NEVER attempt to remove the optional connector cover using your finger nails, this may result in injury.

- ② Attach the optional unit. Insert the connector tightly to avoid a bad contact.
- ③ Remove the paper backing of 2251 OPT sheet supplied as an accessory.
- ④ Attach the new 2251 OPT sheet to the service window.
- ⑤ Program the necessary information from the transceivers key pads or using the cloning software, before operation.

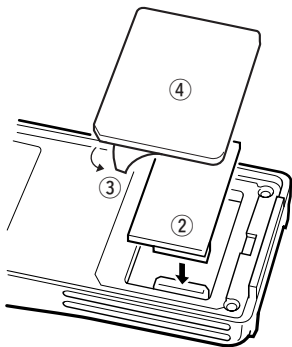

SPECIFICATIONS 14

◆ General

- Frequency range : 144–146 MHz (Tx/Rx)
- Operating temp. range : -10°C to $+60^{\circ}\text{C}$
- Frequency stability : ± 10 ppm (-10°C to $+60^{\circ}\text{C}$)
- Antenna connector : BNC (50 Ω)
- Power supply requirement : 7.2 V DC (6–10.3 V DC acceptable; Icom's battery pack only)
- Current drain (at 7.2 V DC) :
 - Transmit at 5.5 W : Less than 2.0 A
 - at 0.5 W : Less than 0.7 A
 - Receive at max. AF : Less than 250 mA
 - Stand-by : Less than 70 mA
 - Power save : Less than 20 mA
- No. of memory channels : 107 (incl. 1 call and 6 programmed scan edges)
- Tuning steps : 5, 10, 12.5, 15, 20, 25, 30 and 50 kHz
- Dimensions (proj. not incl.) : 54(W) \times 132(H) \times 35(D) mm
- Weight (approx.) : 350 g (with BP-222)
190 g (without battery pack)

◆ Transmitter

- Modulation system : Variable reactance frequency modulation
- Output power (at 7.2 V DC) : 5.5 W (High), 0.5 W (Low)
- Max. frequency deviation : ± 5.0 kHz
- Spurious emissions : Less than -60 dB
- External mic. connector : 3-conductor 2.5 (d) mm; 2.2 k Ω

◆ Receiver

- Receiving system : Double conversion superheterodyne system
- Intermediate frequencies : 1st: 21.7 MHz, 2nd: 450 kHz
- Sensitivity (at 12 dB SINAD) : 0.16 μV typ.
- Squelch sensitivity : 0.1 μV typ.
- Selectivity : 65 dB typ.
- Intermodulation rejection : 65 dB typ.
- Spurious & image rejection : 75 dB typ.
- Audio output power : More than 0.3 W at 10% distortion with an
(at 7.2 V DC) 8 Ω load
- External speaker connector : 2-conductor 3.5 (d) mm; 8 Ω

15 OPTIONS

◇ BATTERY PACKS

Battery Pack	Voltage	Capacity	Output Power	Operating Period* ¹
BP-208 * ²	Battery case for R6 (AA) ×6 alkaline cells		5.5 W	—
BP-209	7.2 V	1100 mAh	5.5 W	7.5 hrs.
BP-210	7.2 V	1650 mAh	5.5 W	11 hrs.
BP-222	7.2 V	600 mAh	5.5 W	4 hrs.

*¹Operating periods are calculated under the following conditions:

Tx:Rx:standby=5:5:90, power save function: auto setting, is activated

*²Operation with the LOW output power selection is recommended.

◇ CHARGER

• **BC-144** DESKTOP CHARGER + **BC-145** AC ADAPTER

For rapid charging of battery packs. An AC adapter is supplied with the charger. Charging time: 1.5 to 2 hrs.

• **BC-137 (#11)** BATTERY CHARGER + **BC-122** AC ADAPTER

For regular charging of battery packs. An AC adapter is additionally required. Charging time: 15 hrs.

• **BC-146** BATTERY CHARGER + **BC-147** AC ADAPTER

For regular charging of battery packs. An AC adapter is additionally required. Charging time: 18.5 hrs.

• **BC-121** MULTI-CHARGER + **AD-94 (#11)** CHARGER ADAPTER (6 pcs.)

For rapid charging of up to 6 battery packs (six AD-94's are required) simultaneously. An AC adapter may be supplied depending on version. Charging time: 1.5 to 2 hrs.

• **BC-119** DESKTOP CHARGER + **AD-94 (#11)** CHARGER ADAPTER

For rapid charging of battery packs. An AC adapter is supplied with the charger. Charging time: 1.5 to 2 hrs.

◇ INTERNAL UNIT

• **UT-108** DTMF DECODER UNIT

Provides pager and code squelch capabilities.

◆ **OTHER OPTIONS**

• **HM-54/HM-46L/HM-75A/HM-131L** SPEAKER-MICROPHONES

Combination speaker-microphones that provide convenient operation while hanging the transceiver from your belt.

HM-75A has 4 function switches for remote control capabilities.

HM-131L has moisture proof construction.

• **HM-128L** EARPHONE-MICROPHONE

You can clip the microphone with PTT switch to your lapel or breast pocket.

• **HS-51** HEADSET

Allows you hands-free operation. Includes VOX, PTT and “one-touch” PTT with time-out timer.

• **MB-68** BELT CLIP

Same as that supplied with the transceiver.

• **MB-74** BELT CLIP

Exclusive alligator-type belt clip.

• **OPC-474** CLONING CABLE

For cloning between transceivers.

• **SP-13** EARPHONE

Provides clear receive audio in noisy environments.

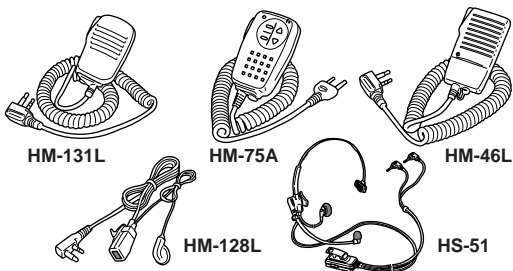

16 CE

ABOUT CE



The IC-T3H complies with the essential requirements of the European Radio and Telecommunication Terminal Directive 1999/5/EC.



This warning symbol indicates that this equipment operates in non-harmonised frequency bands and/or may be subject to licensing conditions in the country of use. Be sure to check that you have the correct version of this radio or the correct programming of this radio, to comply with national licensing requirements.

INSTALLATION NOTES

- When transmitting with a portable radio, hold the radio in a vertical position with its microphone 2.5 to 5 centimeters away from your mouth. Keep antenna at least 2.5 centimeters from your head and body.
- If you wear a portable two-way radio on your body, ensure that the antenna is at least 2.5 centimeters from your body when transmitting.



DECLARATION OF CONFORMITY

We Icom Inc. Japan

1-1-32, Kamiminami, Hirano-ku
Osaka 547-0003, Japan

Declare on our sole responsibility that this equipment complies with the essential requirements of the Radio and Telecommunications Terminal Equipment Directive, 1999/5/EC, and that any applicable Essential Test Suite measurements have been performed.

Kind of equipment: VHF TRANSCEIVER

Type-designation: IC-T3H

Version (where applicable):

This compliance is based on conformity according to Annex III of the directive 1999/5/EC using the following harmonised standards:

- i) Article 3.1a EN 60950 + A11
- ii) Article 3.1b EN 301489-1 and EN 301489-15 (or ETS 300 684)
- iii) Article 3.2 EN 301 783-2
- iv) _____
- v) _____



Düsseldorf 21st May 2001
Place and date of issue

Icom (Europe) GmbH
Himmelgeister strasse 100
D-40225 Düsseldorf

Authorized representative name

T. Maebayashi
General Manager

Signature

Icom Inc.

Count on us!

<Intended Country of Use>

- | | | |
|------------------------------|------------------------------|------------------------------|
| <input type="checkbox"/> GER | <input type="checkbox"/> NED | <input type="checkbox"/> ITA |
| <input type="checkbox"/> AUT | <input type="checkbox"/> BEL | <input type="checkbox"/> GRE |
| <input type="checkbox"/> GBR | <input type="checkbox"/> LUX | <input type="checkbox"/> SWE |
| <input type="checkbox"/> IRL | <input type="checkbox"/> ESP | <input type="checkbox"/> DEN |
| <input type="checkbox"/> FRA | <input type="checkbox"/> POR | <input type="checkbox"/> FIN |

A-6067H-1EU
Printed in Japan
© 2001 Icom Inc.

Icom Inc.

1-1-32 Kamiminami, Hirano-ku, Osaka 547-0003 Japan

**Downloaded by
RadioAmateur.EU**