

ICOM

INSTRUCTION MANUAL

DUAL BAND FM TRANSCEIVER

IC-V21AT

This device complies with Part 15 of the FCC Rules. Operation is subject to the following two conditions: (1) This device may not cause harmful interference, and (2) this device must accept any interference received, including interference that may cause undesired operation.

Icom Inc.

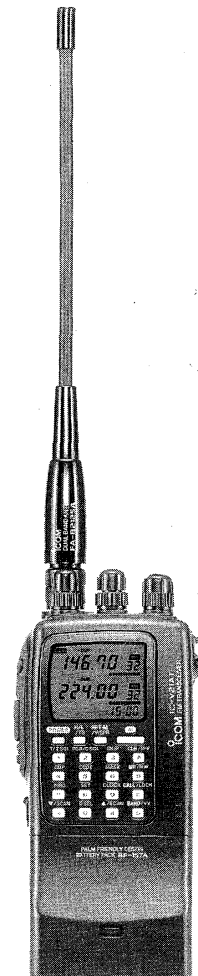

IMPORTANT

READ ALL INSTRUCTIONS carefully and completely before using the transceiver.

SAVE THIS INSTRUCTION MANUAL – This instruction manual contains important safety and operating instructions for the IC-V21AT.

EXPLICIT DEFINITIONS

CAUTION : Equipment damage may occur.

NOTE : If disregarded, inconvenience only. No risk of personal injury, fire or electric shock.

WHEN FIRST APPLYING POWER

◇ Battery pack charging

- ① Attach the battery pack to the transceiver.
- ② Connect the wall charger to the [DC12.5V] jack to charge the battery pack.
 - Charging period of the BP-157A and BP-131A is approx. 15 hrs.

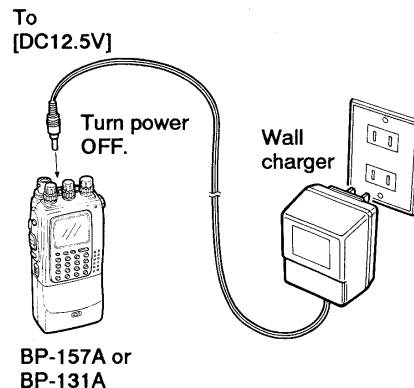

◇ Installing batteries into the optional battery case

Install six dry cell batteries as shown in the figures below.

- Pay attention to the polarities.

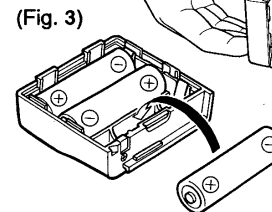
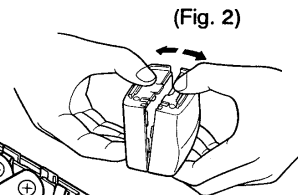
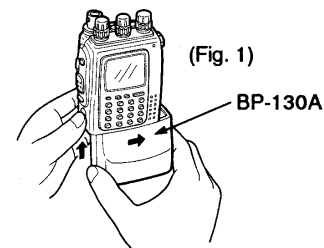

◇ Power ON

Push and hold [POWER] for 1 sec. to turn power ON.

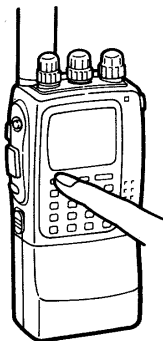

Push and hold [POWER] for 1 sec. again to turn power OFF.

The power key may not function when the transceiver has not been operated for 2 months or more as the internal memory backup battery (rechargeable) may have become depleted. In this case, activate the CPU as described in the box at right.

• Activating the CPU (when the power does not come on)

While pushing the [F] key, attach the charged battery pack. Then, turn power ON.

Pushing [F].

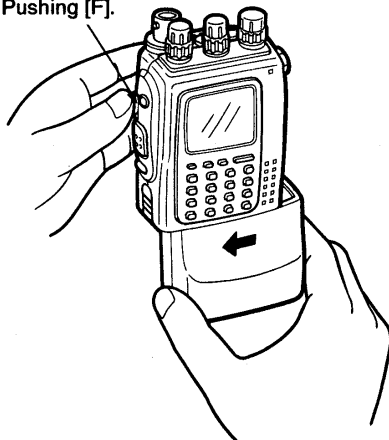

◇ Resetting the transceiver

Reset the transceiver before operating for the first time, or when the internal CPU malfunctions.

- ① Turn power OFF.
- ② While pushing [F], [ⓂCLR] and [⊕▽], push and hold [POWER] for 1 sec. to reset the CPU.

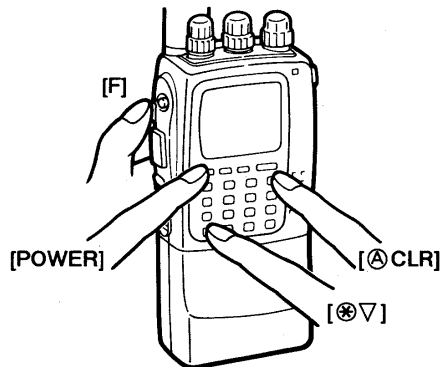

Partial resetting is alternatively available. See p. 47 for details.

CAUTIONS

NEVER connect the transceiver to an AC outlet or to a power source of more than 16 V DC.

NEVER connect the transceiver to a power source using reverse polarity. This connection will ruin the transceiver.

NEVER allow children to touch the transceiver.

AVOID using or placing the transceiver in direct sunlight or in areas with temperatures below -10°C ($+14^{\circ}\text{F}$) or above $+60^{\circ}\text{C}$ ($+140^{\circ}\text{F}$).

BE CAREFUL! When transmitting for a long time with high output power, the rear panel will become hot.

The use of non-Icom battery packs/chargers may impair transceiver performance and invalidate the warranty.

Even when the transceiver power is OFF, a slight current still flows in the circuits. Remove the battery pack or case from the transceiver when not using the transceiver for a long time. Otherwise, the battery pack or installed dry cell batteries in the battery case will become exhausted.

UNPACKING

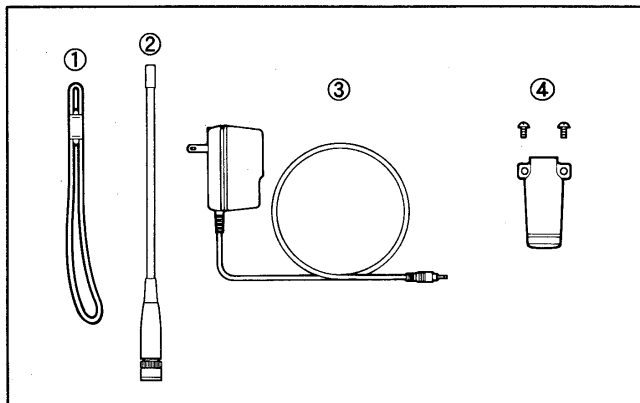

Accessories included with the transceiver:	Qty.
① Handstrap	1
② Antenna (FA-B2125A)	1
③ Wall charger	1
④ Belt clip and screws	1 set
Battery pack (BP-157A) (attached with the transceiver)	1

TABLE OF CONTENTS

IMPORTANT	i	■ Repeater memory	19	■ Manual assignment	34
EXPLICIT DEFINITIONS	i	■ Auto repeater power control	19	14 CLOCK AND TIMERS	35-38
WHEN FIRST APPLYING POWER	i-ii	7 MEMORY OPERATION	20-22	■ Clock operation	35
CAUTIONS	iii	■ General description	20	■ Timer mode	36
UNPACKING	iii	■ Memory channel selection	20	■ Auto power-off	36
TABLE OF CONTENTS	iv	■ Programming a memory channel	21	■ Power-on timer	37
		■ Transferring memory contents	22	■ Power-off timer	38
1 PANEL DESCRIPTION	1-6	■ Masking a memory	22	15 PAGER AND CODE SQUELCH	39-43
■ Front and side panels	1	8 CALL CHANNEL OPERATION	23	■ Pager function	39
■ Top panel	2	■ Calling up a call channel	23	■ Code channel	40
■ Keyboard	3	■ Transferring call channel contents	23	■ Code programming	41
■ Function display	5	■ Programming a call channel	23	■ Pager operation	41
2 BATTERY PACK CHARGING	7-8	9 SCAN OPERATION	24-29	■ Code squelch operation	43
■ Battery pack charging	7	■ Scan types	24	16 POCKET BEEP AND TONE SQUELCH	44
■ Charging precautions	7	■ Full scan	25	■ Pocket beep operation	44
■ About the battery pack	7	■ Programmed scan	25	■ Tone squelch operation	44
■ Charging connections	8	■ Programming scan edges	26	17 OTHER FUNCTIONS	45-48
3 ACCESSORY ATTACHMENT	9	■ Frequency skip function	27	■ Power saver	45
4 SETTING A FREQUENCY	10-13	■ Memory scan	28	■ Battery voltage indication	45
■ Main band	10	■ Memory skip scan	28	■ PTT lock function	46
■ VFO and memory modes	10	■ Skip channel setting	29	■ Beep tone on/off	46
■ Setting via the keyboard	11	■ Scan resume condition	29	■ Receive indicator on/off	46
■ Lock function	11	10 PRIORITY WATCH	30	■ LCD contrast	46
■ Presetting for the tuning dial	12	■ Priority watch types	30	■ External speaker selection	47
■ Setting via Δ / ∇ key	13	■ Priority watch operation	30	■ Partial resetting	47
■ Using the tuning dial	13	11 DTMF MEMORY	31	■ Optional HM-75A functions	48
■ LCD lighting	13	■ Programming a DTMF code	31	18 MODE CONSTRUCTION CHART	49-50
5 BASIC OPERATION	14-16	■ Transmitting a DTMF code	31	19 TROUBLESHOOTING	51
■ Receiving	14	12 OPTIONAL WHISPER FUNCTION	32	20 SPECIFICATIONS	52
■ V by V function	15	■ General operation	32	21 OPTIONS	53-54
■ Transmitting	15	■ Time-out timer setting	32		
6 REPEATER OPERATION	17-19	13 AI FUNCTION	33-34		
■ Operation	17	■ What does AI in the transceiver do?	33		
■ Tone information	17	■ Learning function	34		
■ Subaudible tone	18	■ Learning function on/off	34		
■ Offset frequency	18				

PANEL DESCRIPTION

Front and side panels

MONITOR SWITCH [MONI] (p. 14)
Manually opens the main band's squelch and monitors the transmit frequency.

FUNCTION SWITCH [F] (pgs. 3, 4)
While pushing this switch, other switches and the tuning dial perform secondary functions.

- "Push [F] + a switch" means "while pushing the [F] switch, push the switch."

PTT SWITCH [PTT] (p. 15)
Push and hold to transmit; release to receive.

LIGHT SWITCH [LIGHT] (p. 13)

- Lights the display and keyboard back-lighting for 5 sec.
- [F] + [LIGHT] manually turns the back-lighting ON and OFF.

BATTERY PACK RELEASE BUTTON
Opens the latch for battery pack removal when pushed upwards.

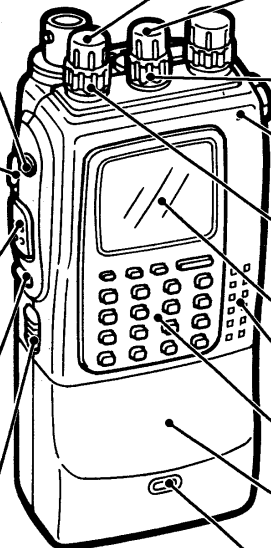

144 VOLUME CONTROL [VOL] (p. 14)
Adjusts the 144 MHz band audio level.

222 VOLUME CONTROL [VOL] (p. 14)
Adjusts the 222 MHz band audio level.

222 SQUELCH CONTROL [SQL] (p. 14)
Varies the 222 MHz band squelch threshold point for noise mute.

TX/RX INDICATOR (pgs. 14, 15)

144 SQUELCH CONTROL [SQL] (p. 14)
Varies the 144 MHz band squelch threshold point for noise mute.

FUNCTION DISPLAY (pgs. 5, 6)

SPEAKER/MICROPHONE

KEYBOARD (pgs. 3, 4)

BATTERY PACK/CASE (pgs. i, 7, 8)

OPTIONAL SUB MICROPHONE (p. 32)
Used for the optional whisper function. (The BP-131A or BP-132A is required.)

Top panel

ANTENNA CONNECTOR (p. 9)
Connects the supplied antenna.

EXTERNAL DC POWER JACK [DC12.5V] (p. 53)
Allows operation with a 12.5 V DC power source using the optional cables, CP-13 or OPC-288.

CAUTION: Operation with an external DC power source simultaneously charges batteries inside the battery case or the battery pack. This may cause battery leakage and damage the transceiver or cause battery overcharging and shorten the life of the battery pack, respectively.

TUNING DIAL [DIAL]
Sets operating frequency, memory channel and set mode contents.

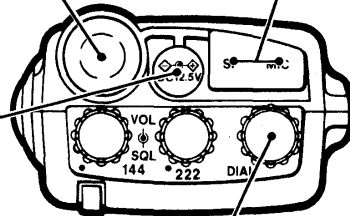

EXTERNAL SPEAKER AND MICROPHONE JACKS [SP]/[MIC]

Connect an optional speaker-microphone or headset, if desired. The internal microphone will not function when either is connected. (See pgs. 53, 54 for options.)

External connection

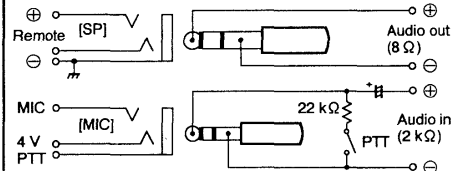

The above diagram does not apply when a condenser microphone is connected.

External audio output

Audio output from the [SP] jack can be selected for the 144 MHz band and/or the 222 MHz band using set mode. When connecting a TNC, etc., set the undesired band audio to the internal speaker. (p. 47)





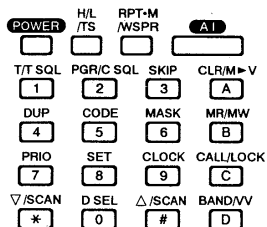





1 PANEL DESCRIPTION

Keyboard



KEY	FUNCTION	SECONDARY FUNCTION (+ [F])
T/T SQL 1	<ul style="list-style-type: none"> • Input the appropriate digit while in VFO mode. (p. 11) • Input the first digit while in memory mode. (p. 20) • Transmit the appropriate DTMF code while transmitting. 	Activates the following functions in this sequence: subaudible tone encoder → pocket beep → tone squelch → non-tone operation. (pgs. 17, 44)
PGR/C SQL 2		Activates the following functions in this sequence: pager → code squelch → non-selective calling. (pgs. 41–43)
SKIP 3		Sets the selected memory channel as a skip memory channel in memory mode. (p. 29)
DUP 4		Selects the duplex direction in this sequence: – duplex → + duplex → simplex. (p. 17)
CODE 5		Programs the code channel for pager and code squelch operation. (p. 41)
MASK 6		Hides and displays the selected memory channel in memory mode. Memory channel 1 cannot be hidden. (p. 22)
PRIO 7		Starts the priority watch. (p. 30)
SET 8		Enters set mode. (Various pages)
CLOCK 9		<ul style="list-style-type: none"> • Indicates the clock display. (p. 35) • Sets clock time when pushed 2 times. (p. 35)
D SEL 0		Selects the dial select step. (p. 12)

PANEL DESCRIPTION 1

KEY	FUNCTION	SECONDARY FUNCTION (+ [F])
POWER 	Turns power ON and OFF when pushed for 1 sec. (p. ii)	The same as the primary function at left.
H/L /TS 	<ul style="list-style-type: none"> • Selects high or low output power. (p. 16) • The tuning dial selects a low output power level while pushing this switch. (p. 16) 	The tuning dial selects the tuning step increments in VFO mode. (p. 12)
RPT-M /WSPR 	<ul style="list-style-type: none"> • Calls up the repeater memory. (p. 19) 	Turns the optional whisper function ON and OFF. (p. 32)
AI 	<ul style="list-style-type: none"> • Activates the function indicated in the AI function indicator. (p. 34) • The tuning dial selects the AI functions while pushing this switch. (p. 34) 	When the AI function indicator shows battery voltage: resets the reference voltage. (p. 45)
CLR/M→V 	<ul style="list-style-type: none"> • Clears frequency input before entry. (p. 11) • Selects VFO mode. (p. 10) 	When selecting memory mode or a call channel: transfers the contents into the VFO when pushed and held. (pgs. 22, 23)
MR/MW 	<ul style="list-style-type: none"> • Selects memory mode from VFO mode. (p. 20) • Increments the memory channel number in units of 10 when memory mode has been selected. (p. 20) 	Writes the VFO contents into the memory channel or call channel when pushed and held. (pgs. 21, 23)
CALL/LOCK 	Calls up a call channel. (p. 23)	Turns the lock function ON and OFF. (p. 11)
BAND/VV 	Assigns the main band to the 144 MHz band or 222 MHz band alternately. (p. 10)	Turns the V by V function ON and OFF. (p. 15) Turns the sub band display ON and OFF when pushed and held. (p. 14)
∇/SCAN * △/SCAN #  	<ul style="list-style-type: none"> • Changes the frequency in VFO mode. (p. 13) • Starts the full scan or memory scan when pushed and held. (pgs. 25, 28) 	Starts the programmed scan or memory skip scan. (pgs. 25, 28)

1 PANEL DESCRIPTION

■ Function display

MAIN BAND INDICATORS (p. 10)

Appears in one of two positions to show the main band for transmitting and function control.

FREQUENCY READOUTS

Show the operating frequency, set mode contents, etc.

- The decimal point of the frequency flashes while scanning. (pgs. 24–29)
- “P” or “C” appears in place of the 100 MHz digit while pager or code squelch is in use, respectively. (pgs. 41–43)

PTT LOCK INDICATOR (p. 46)

Appears while the PTT switch is electronically locked.

WHISPER FUNCTION INDICATOR (p. 32)

Appears while the optional whisper function (telephone-style operation) is in use. Battery pack BP-131A or BP-132A is required for operation.

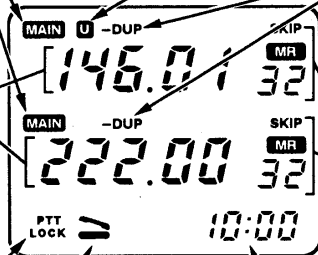

V BY V INDICATOR (p. 15)

Appears when the V by V function (two frequencies in one band) is in use.

DUPLEX INDICATORS (p. 17)

- “-DUP” or “DUP” appears during semi-duplex operation (repeater operation).

MEMORY CHANNEL INDICATOR (p. 20)

Shows the selected memory channel number.

- “MR” appears when memory mode is selected.
- “SKIP” appears when the selected memory channel is set as a skip channel. (p. 29)
- “” appears when a call channel is selected. (p. 23)

AI FUNCTION INDICATOR (p. 33)

Shows an assignment function of the [AI] key, current time or percentage of the battery pack's voltage.

TONE INDICATOR

Appears while the tone squelch unit is in use.

- "T" appears while the subaudible tone encoder is in use. (p. 17)
- "T SQL" appears while the tone squelch is in use. (p. 44)
- "T SQL (T)" appears while the pocket beep function is in use. (p. 44)

PRIORITY INDICATOR (p. 30)

Appears while the priority watch is activated; flashes while the watch is paused.

S/RF INDICATORS

- Show the relative signal strength while receiving signals. (p. 14)
- Show the output power selection while transmitting. (p. 16)

LOW POWER INDICATOR

- "LOW" appears while low output power is selected. (p. 16)
- "LOW" blinks while auto repeater power control is in use. (p. 19)
- "E LOW" appears while the economical low power (20 mW) is assigned to low output power and low power is selected. (p. 16)

AUTO POWER-OFF INDICATOR

(p. 36)

Appears while the auto power-off function is in use.

TIMER INDICATOR (pgs. 37, 38)

- "⊖" appears while the power-on or power-off timer is in use.
- "ON" appears while the power-on timer is in use.
- "OFF" appears while the power-off timer is in use.

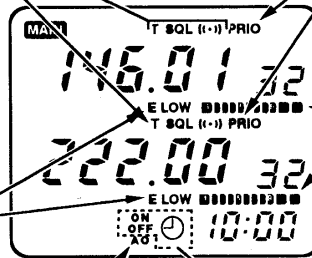

■ Battery pack charging

The supplied BP-157A BATTERY PACK includes rechargeable Ni-Cd batteries and can be charged approx. 300 times. Charge the battery pack before first operating the transceiver or when the battery pack becomes exhausted. (p. 8)

If you want to be able to charge the battery pack more than 300 times, the following points should be observed:

1. Avoid overcharging. The charging period should be less than 48 hours.
2. Use the battery until it becomes almost completely exhausted under normal conditions. We recommend battery charging after transmitting becomes impossible.

■ Charging precautions

NEVER attempt to charge dry cell batteries. This will cause internal liquid leakage and damage the battery case or transceiver.

NEVER connect two or more chargers at the same time.

Charging may not occur in extreme cold (under 0 °C; + 32 °F) or extreme heat (over + 40 °C; + 104 °F).

■ About the battery pack

◇ Operating period

Depending on the attached battery pack, the operating period of the transceiver varies. Refer to the table below.

BATTERY PACK	OUTPUT VOLTAGE	BATTERY CAPACITY	OPERATING PERIOD (Approx.)
BP-131A, BP-157A	7.2 V	900 mAh	6 h 50 m
BP-132A	12.0 V	600 mAh	4 h

Operating condition: Transmitting at high power for 1 min., receiving for 1 min. and standby (power saved) for 8 min. with the sub band OFF. Operating periods are estimated values and vary depending on output power, temperature, etc.

◇ Battery pack life

When the operating period becomes extremely short even after charging the battery pack fully, a new battery pack is needed.

◇ When the battery is exhausted:

- Transmitting is interrupted while holding the [PTT] switch.
- The economical low power is automatically selected by the automatic power down function. (p. 16)
- The transceiver emits a battery alarm sound.
- The [POWER] switch cannot turn the power OFF. (At this time, remove the battery pack from the transceiver.)

Charging connections

Regular charging

Attach the supplied battery pack or optional BP-131A; then, connect the supplied wall charger to the transceiver as shown below.

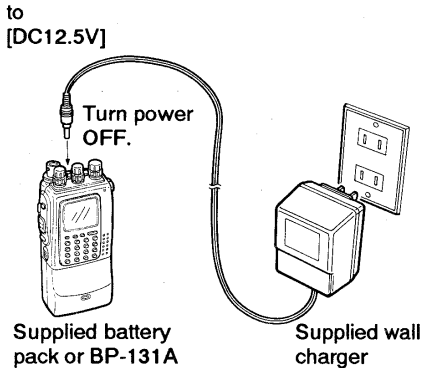

- The optional CP-13/L or OPC-288/L with a 12–16 V DC can be used for the charging power source.

BATTERY PACK	BP-131A, BP-157A	BP-132A
APPROX. CHARGING PERIOD	15 hrs.	N/A

Rapid charging

- Insert the optional AD-28 BATTERY PACK ADAPTER into the charging slot of the BC-79 DESKTOP CHARGER.
- Firmly insert a battery pack into the AD-28.

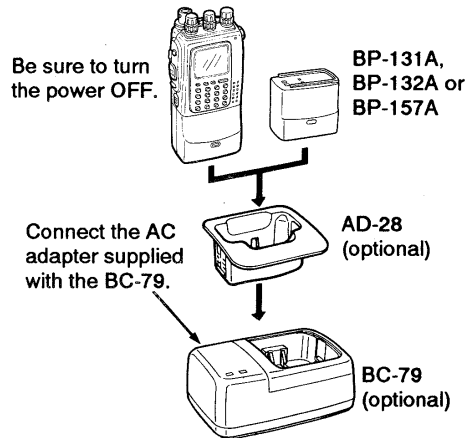

BATTERY PACK	BP-131A, BP-157A	BP-132A
APPROX. CHARGING PERIOD	1 hr.	1.5 hrs.

Charging without transceiver

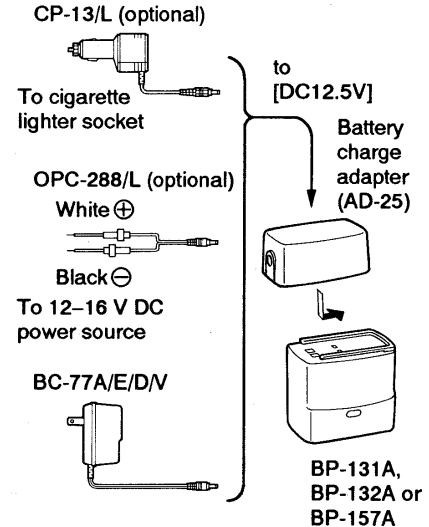

- NEVER** connect the above options to the BP-130A.

BATTERY PACK	BP-131A, BP-157A	BP-132A
APPROX. CHARGING PERIOD	15 hrs.	20 hrs.

3

ACCESSORY ATTACHMENT

◇ Antenna

Insert the supplied antenna into the antenna connector and rotate the antenna as shown in the diagram below.

KEEP the jack cover attached when jacks are not in use to avoid bad contacts.

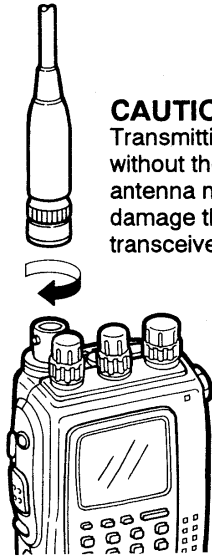

CAUTION:
Transmitting without the antenna may damage the transceiver.

◇ Belt clip

Remove the plastic screws, then attach the belt clip with the supplied metal screws. Conveniently attaches to your belt.

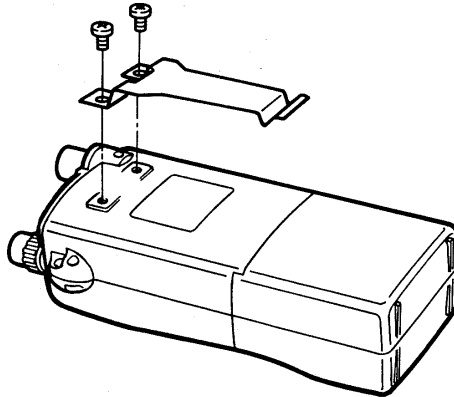

◇ Handstrap

Install the handstrap as shown in the figure below. Facilitates carrying.

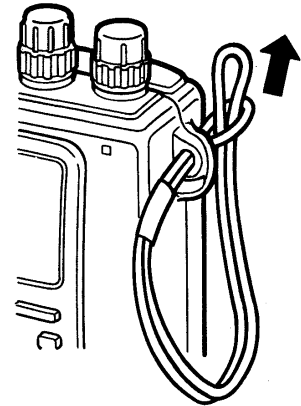

■ Main band

This transceiver can receive a 144 MHz and a 222 MHz band signal simultaneously. To change frequency or to activate a function, you must designate the band, 144 MHz or 222 MHz, as the main band. All switches and the tuning dial affect only the main band.

The [BAND] switch changes the main band between the 144 MHz band and the 222 MHz band.

- "MAIN" indicator shows the selected band as the main band.

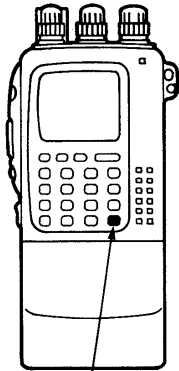

Band switch

Main band indicator



■ VFO and memory modes

This transceiver has 2 normal operating modes: VFO mode and memory mode. You can select VFO mode or memory mode independently on each band. Pushing [CLR] one or more times selects VFO mode. (pgs. 49-50)

VFO mode (for setting a frequency):

This mode is used for setting a desired frequency within the band range.

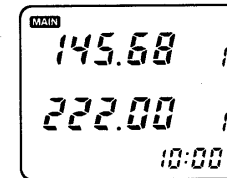

"MR" is not indicated.

Memory mode:

This mode is used for operation of memory channels which have programmed frequencies. 32 memory channels are available on each band to store 32 different frequencies.



"MR" is indicated.

What is VFO?

VFO is an abbreviation of Variable Frequency Oscillator. Frequencies for transmitting and receiving are generated and controlled by the VFO.

4 SETTING A FREQUENCY

■ Setting via the keyboard

- ① Select the desired band with [D BAND].
- ② Select VFO mode if another mode has been selected.
 - Push [A CLR] one or more times to select VFO mode. See p. 10 for more about VFO mode.
- ③ Push 4 appropriate digit keys to input a frequency.
 - When a wrong digit is input, push [A CLR] to clear the input, then start again.
 - "0," "2," "5," or "7" are acceptable for the 1 kHz digits (depending on the 10 kHz digit).

■ Lock function

The lock function prevents accidental frequency changes and accidental function activation.

- ① Push [F] + [C LOCK] to turn the function ON.
 - Two "L" 's appear instead of the memory channel number.
- ② To turn the function OFF, repeat step ① above.
 - Two "L" 's disappear.

NOTE: Output power can be selected between high and one of low powers even if the lock function is in use.

[EXAMPLE]: Setting the frequency to 145.360 MHz.

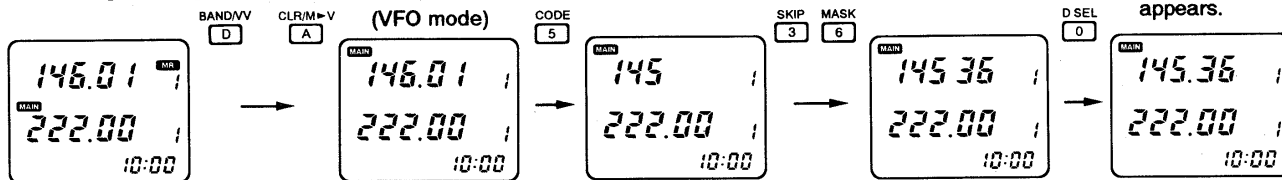

[EXAMPLE]: Setting the frequency to 222.3875 MHz.

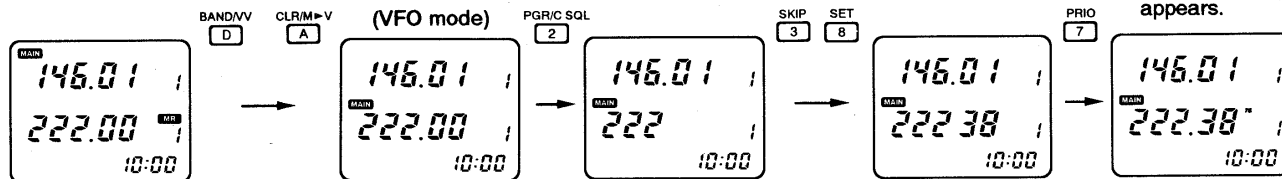

■ Presetting for the tuning dial

◇ Tuning step selection

A desired tuning step can be selected for each band. This transceiver has 8 tuning steps as follows:

- 5 kHz
- 10 kHz
- 12.5 kHz
- 15 kHz
- 20 kHz
- 25 kHz
- 30 kHz
- 50 kHz

- ① Select the desired band with [ⓐ BAND].
- ② Select VFO mode if another mode has been selected.
- ③ Push [F] + [H/L/TS] to enter the tuning step setting condition.
 - Previously selected tuning step appears.
- ④ Rotate the tuning dial to select the desired tuning step.
- ⑤ Push [H/L/TS] to set the selected tuning step.

NOTE: For convenience, select a tuning step that matches the frequency intervals of repeaters in your area.

[DISPLAY EXAMPLE]

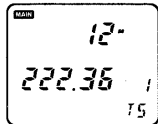

12.5 kHz tuning step in
144 MHz band

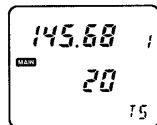

20 kHz tuning step in
222 MHz band

◇ Setting a dial select step

In VFO mode, rotating the tuning dial while pushing [F] changes the frequency in 100 kHz or 1 MHz steps, or the memory channel number.

This function is useful for quick tuning or memory channel selection in VFO mode such as when programming 2 or more memory channels. A dial select step can be set in each band.

- ① Select the desired band with [ⓐ BAND].
- ② Select VFO mode if another mode has been selected.
- ③ Push [F] + [ⓐ D SEL] one or more times to set the dial select step.
 - The selected digit (100 kHz or 1 MHz) or memory channel number blinks.
- ④ While pushing [F], rotate the tuning dial to change the frequency or memory channel using the dial select tuning.

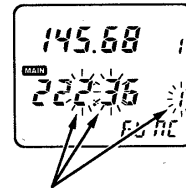

Selected digit (100 kHz or 1 MHz) or memory channel number blinks while setting the dial select step.

4 SETTING A FREQUENCY

■ Setting via ▽ / △ key

- ① Select the desired band with [D BAND].
- ② Select VFO mode if another mode has been selected.
- ③ Push [F△] or [F▽] to change the frequency.
 - The frequency changes according to the tuning step. (p. 12)
 - Pushing the key for more than 0.5 sec. will activate full scan.
 - If the scan is started, push [F△] or [F▽] again to stop it.

■ Using the tuning dial

- ① Select the desired band with [D BAND].
- ② Select VFO mode if another mode has been selected.
- ③ Rotate the tuning dial to set the frequency.
- ④ To change the frequency quickly, rotate the tuning dial while pushing [F].
 - See p. 12 for setting a dial select step details.

■ LCD lighting

For easy operation at nighttime, the transceiver has an LCD (Liquid Crystal Display) and keyboard lighting function with a 5 sec. timer.

◇ 5 sec. timer

- ① Push [LIGHT] to turn the lighting ON.
- ② The lighting will automatically turn OFF when no switches or the tuning dial have been operated for 5 sec.
- ③ To turn OFF the lighting manually, push [LIGHT] again.

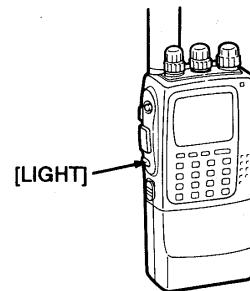

◇ Continuous lighting

- Push [F] + [LIGHT] for continuous lighting.
 - Push [LIGHT] to turn the lighting OFF.

NOTE: Continuous lighting remains activated even when the power is turned OFF and ON again.

■ Receiving

- ① Turn power ON.
- ② Set the 144 MHz band audio level.
 - Rotate 144 [SQL] maximum counterclockwise.
 - Rotate 144 [VOL] to adjust the desired audio output level.
 - Rotate 144 [SQL] clockwise until noise is muted.
- ③ Set the 222 MHz band audio level.
 - Rotate 222 [SQL] maximum counterclockwise.
 - Rotate 222 [VOL] to adjust the desired audio output level.
 - Rotate 222 [SQL] clockwise until noise is muted.
- ④ Set the 144 MHz and 222 MHz bands frequencies with [D BAND] and the tuning dial. (pgs. 10–13)

When a signal is received:

- The TX/RX indicator lights up in green.
- Squelch opens and audio is emitted from the speaker.
- The receiving band's S/RF indicator shows the relative signal strength.

NOTE1: When a [SQL] control is set too "tight" (extremely clockwise), squelch may not open for weak signals. To receive weak signals, set the squelch to a "loose" (less clockwise) position or use the monitor function.

NOTE2: The transceiver receives in the sub band even when transmitting in the main band. However, the receiver's sensitivity decreases during transmission.

◇ Monitor function

This function is used to listen to weak signals without disturbing the squelch setting or to open the main band squelch manually even when the pager, code squelch, pocket beep or tone squelch is in use.

Push and hold [MONI] to open the main band squelch.

- While duplex is ON for repeater operation, the transmitting frequency can be monitored with [MONI].

◇ Single band function

This function turns the sub band circuit OFF and allows the transceiver to be used as a mono band transceiver. This function is useful to conserve battery power.

- ① Push [F] + [D BAND] for 1 sec. to turn the sub band OFF.
 - The sub band frequency, etc. disappears.
 - The operating band can be changed with [D BAND].
- ② To turn the sub band ON again, repeat step ① above.
 - The sub band frequency, etc. appears.

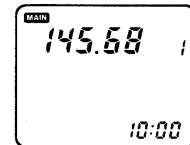

The display shows the 222 MHz band circuit is turned OFF.

5 BASIC OPERATION

■ V by V function

The transceiver can receive 2 frequencies simultaneously on either 144 MHz band or 222 MHz band using the V by V function.

- ① Turn the single band function OFF if it is in use. (p. 14)
- ② Push [F] + [ⓈVV] once to receive 2 frequencies on the 222 MHz band or twice to receive 2 frequencies on the 144 MHz band.
 - "Ⓢ" appears on the 144 MHz band display.
 - Both band frequency displays show 222 MHz band frequencies or 144 MHz band frequencies while the function is in use.
- ③ Push [F] + [ⓈVV] once or twice to cancel.

NOTE:

- The frequency which would normally be in the other band is weaker, especially when the 2 frequencies are separated by more than 10 MHz.
- Memory channels and repeater memory are used for both frequency displays.
- The optional whisper function cannot be used.
- Repeater memory cannot be changed while it is indicated on the sub band frequency display.
- The receive frequency of the sub band display is muted during main band transmitting.

■ Transmitting

CAUTION: Transmitting without an antenna may damage the transceiver.

- ① Select the 144 MHz band or 222 MHz band as the main band for transmitting.
- ② Set the operating frequency. (pgs. 10–13)
- ③ Push and hold [PTT] to transmit.
 - The TX/RX indicator lights up in red.
 - The S/Rf indicator shows the output power selection.
 - The sub band can receive while transmitting in the main band.
- ④ Speak into the microphone using your normal voice level.
 - DO NOT hold the transceiver too close to your mouth or speak too loudly. This may distort the signal.
- ⑤ Release [PTT] to return to receive.

■ Operation

A repeater amplifies a received signal and transmits it at a different frequency. When using a repeater, the transmit frequency is shifted from the receive frequency by the offset frequency. (p. 18) It is convenient to program repeater information into a memory channel. (p. 21)

- ① Select the desired band with [ⓐ BAND].
- ② Set the receive frequency (repeater output frequency). (pgs. 10–13)
- ③ Push [F] + [ⓐ DUP] to select –duplex or push it again for + duplex.
 - “–DUP” or “DUP” appears to indicate the transmit frequency for minus shift or plus shift, respectively.
 - When the auto repeater power control is in use, “LOW” blinks and the output power is automatically selected. (p. 19)
- ④ Push and hold [PTT] to transmit.
 - The displayed frequency automatically changes to the transmit frequency (repeater input frequency).
 - When the repeater requires a tone, see section at right.
 - The operating condition is automatically programmed into a repeater memory. See p. 19 for details.
 - If “o.FF” appears, confirm the offset frequency. (p. 18)
- ⑤ Release [PTT] to receive.
- ⑥ Push and hold [MONI] to check whether the other station's transmit signal can be directly received or not.

■ Tone information

SUBAUDIBLE TONE

- ① Push [F] + [ⓐ T/TSQL] several times until only “T” appears to turn ON the subaudible tone encoder.
 - To set the subaudible tone frequency, see “Subaudible tone” on the page at right.
- ② Push [F] + [ⓐ T/TSQL] several times until “T” disappears to turn OFF the subaudible tone encoder.

DTMF TONES

While pushing [PTT], push the desired digit key to transmit DTMF tones.

- The transceiver has 4 DTMF memory channels. See p. 31 for details.

Subaudible tone USING SET MODE

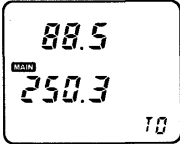

The display shows an 88.5 Hz subaudible tone frequency for the 144 MHz band and a 250.3 Hz subaudible tone frequency for the 222 MHz band.

Separate setting for each band.

- ① Select the desired mode or channel you wish to set the subaudible tone frequency to, such as VFO mode, memory channel or call channel.
 - The subaudible tone frequency is independently programmed into each mode or channel.
- ② Push [F] + [ⓈSET] to enter set mode.
- ③ Push [⊕▽] or [⊕△] until "TO" appears as shown above.
- ④ Rotate the tuning dial to select the desired frequency.
- ⑤ Push [ⓁBAND] to change the band, if desired.
- ⑥ Push [ⓐCLR] to set the value and to exit set mode.

• Subaudible tone frequency list

67.0	85.4	103.5	127.3	156.7	192.8	241.8
71.9	88.5	107.2	131.8	162.2	203.5	250.3
74.4	91.5	110.9	136.5	167.9	210.7	
77.0	94.8	114.8	141.3	173.8	218.1	
79.7	97.4	118.8	146.2	179.9	225.7	
82.5	100.0	123.0	151.4	186.2	233.6	

(Unit: Hz)

Offset frequency USING SET MODE

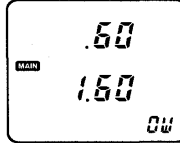

The display shows a 0.6 MHz (600 kHz) offset frequency for the 144 MHz band and a 1.6 MHz offset frequency for the 222 MHz band.

Separate setting for each band.

- ① Select the desired mode or channel you wish to set the offset frequency to, such as VFO mode, memory channel or call channel.
 - The offset frequency is independently programmed into each mode or channel.
- ② Push [F] + [ⓈSET] to enter set mode.
- ③ Push [⊕▽] or [⊕△] until "OW" appears as shown above.
- ④ Rotate the tuning dial to set the desired frequency.
 - Selectable step increment is the same as the preset tuning step. (p. 12)
 - Rotating the tuning dial while pushing [F] changes the frequency in 100 kHz steps.
- ⑤ Push [ⓁBAND] to change the band, if desired.
- ⑥ Push [ⓐCLR] to set the value and to exit set mode.

6 REPEATER OPERATION

■ Repeater memory

This transceiver has a repeater memory in each band to store repeater information separately from regular memory channels and the call channel.

When transmitting with duplex ON, the following information is automatically programmed into the repeater memory.

- Repeater output frequency (your receiving frequency).
- “- DUP” or “DUP” setting and offset frequency.
- “T” setting and subaudible tone frequency (when used).

After you operate the transceiver in simplex, you can easily call up the repeater memory.

- ① Push [RPT•M] to call up the repeater memory.
 - Programmed repeater information and “rP” appear.
 - Repeater memory is blanked after CPU resetting.
- ② To return to the normal operating mode (VFO or memory mode), push [RPT•M] again.

[REPEATER MEMORY]

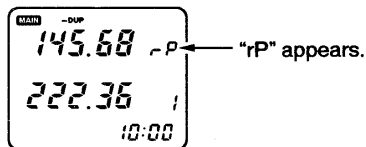

■ Auto repeater power control

This transceiver automatically selects the output power while in duplex operation. When receiving with duplex ON, the transceiver monitors the signal strength every 1 sec. and determines an output power between high, low 1–low 3. This function automatically conserves the battery power during repeater communication.

- While the function is in use, the “LOW” indicator blinks and [H/L] cannot select the output power.

This function may not select an appropriate output power because of the repeater location, propagation conditions, etc.

— USING SET MODE —

SETTING THE AUTO REPEATER POWER CONTROL FUNCTION ON/OFF

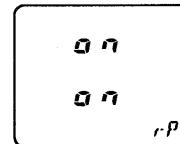

The auto
repeater
power control
function is ON.

- ① Push [F] + [Ⓢ SET] to enter set mode.
- ② Push [⊕ ▽] or [⊕ △] until “rP” appears as shown above.
- ③ Rotate the tuning dial to turn the auto repeater power control function ON or OFF.
- ④ Push [Ⓐ CLR] to set the condition and to exit set mode.

General description

The transceiver has 32 memory channels (plus 2 scan edge memory channels) on each band for storage of often-used frequencies. You can program the following data into each memory channel separately.

- Operating frequency (pgs. 11–13)
- Duplex direction (DUP or – DUP) (p. 17)
- Offset frequency (p. 18)
- Subaudible tone frequency (p. 18)
- Subaudible tone encoder ON/OFF (p. 17)
- Tone squelch ON/OFF (p. 44)
- Skip information* (p. 29)

* Except for the scan edge memory channels.

MEMORY CHANNEL ARRANGEMENT

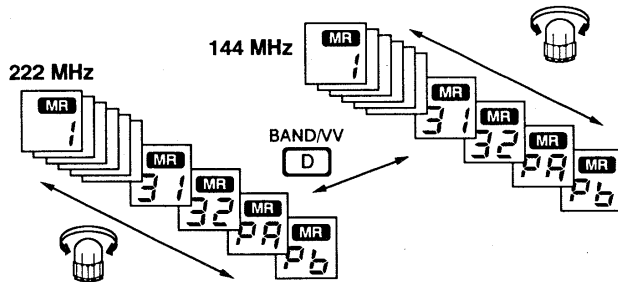

Memory channel selection

- ① Select the desired band with [ⓐ BAND].
- ② Push [ⓑ MR] to select memory mode.
 - "MR" appears.
 - If the call channel or repeater memory has been selected, push [ⓒ CLR] to exit.
- ③ Select the desired memory channel.

Using the tuning dial:

Rotate [DIAL] to select the desired memory channel.

- Memory channels "PA" and "Pb" are scan edge channels. (p. 26)
- To select a masked channel, rotate [DIAL] while pushing [F].

Using the keyboard:

- Push a numeral key to enter the first digit into the memory channel.
 - When "PA" or "Pb" has been selected, use another method to select the channel.
- Push [ⓑ MR] to change the memory channel in units of 10.
 - All memory channels except "PA" or "Pb" can be selected.

Using the Δ/▽ keys:

Push [Ⓧ▽] or [Ⓧ△] to change the memory channel.

- Masked channels cannot be selected. (p. 22)
- Pushing [Ⓧ▽] or [Ⓧ△] for more than 0.5 sec. will activate memory scan. If the scan is started, push [Ⓧ▽] or [Ⓧ△] again to stop the scan.

- ④ To return to VFO mode, push [ⓐ CLR].

7 MEMORY OPERATION

■ Programming a memory channel

VFO mode settings, including the set mode contents such as subaudible tone frequency, etc., are programmed into a memory channel.

- ① Select the desired band with [D BAND].
- ② Select the memory channel to be programmed:
 - Push [B MR] to select memory mode. ("MR" appears.)
 - Rotate the tuning dial to select the memory channel.
 - To select a masked channel, rotate the tuning dial while pushing [F].

- ③ Set the desired frequency in VFO mode:
 - Push [A CLR] to select VFO mode.
 - Set the desired frequency using the keyboard or tuning dial.
 - Set other data (e.g. offset frequency, duplex direction, subaudible tone encoder ON/OFF and its frequency), if required.
- ④ Push [F] + [B MW] for 1 sec. to program.
 - If the beep tone is ON, 3 beeps alert you that the VFO contents, including the duplex information, subaudible tone frequency, etc., are programmed.

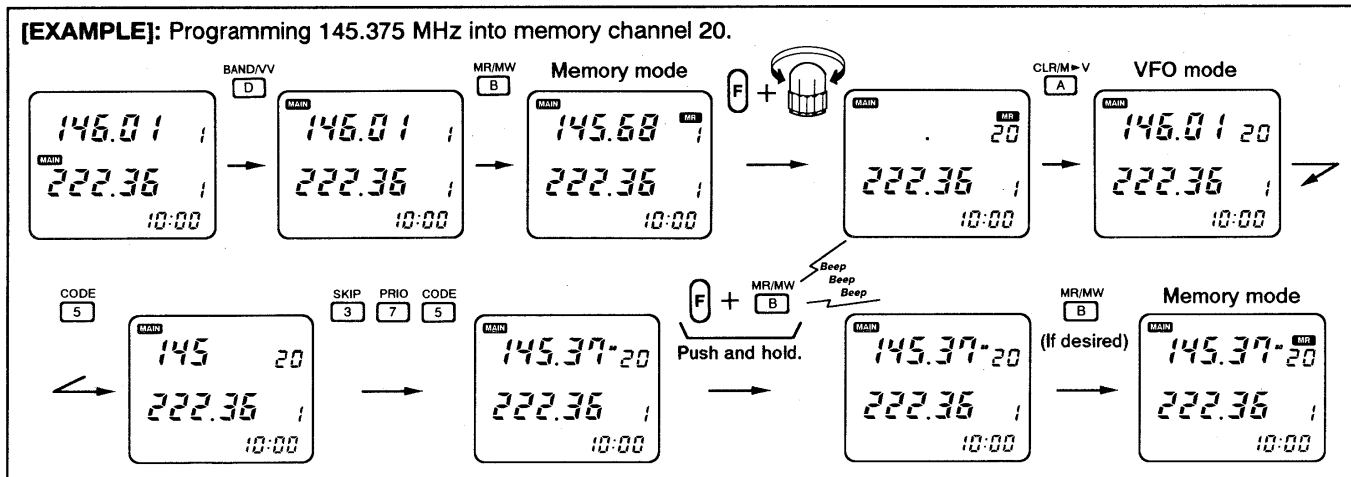

■ Transferring memory contents

This function transfers a memory channel's contents into a VFO. This is useful for searching for signals around a memory channel frequency and for recalling the offset frequency, subaudible tone frequency, etc.

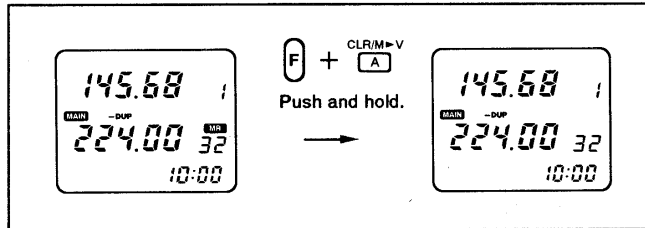

- ① Select the desired band with [**B** BAND].
- ② Select the memory channel to be transferred:
 - Push [**M** MR] to select memory mode. ("MR" appears.)
 - Rotate the tuning dial to select the memory channel.
- ③ Push [**F**] + [**A** M ▶ V] for 1 sec.
 - "MR" disappears as VFO mode is automatically selected.
 - If the beep tone is ON, 3 beeps alert you that the memory channel contents, including the duplex information, subaudible tone frequency, etc., are transferred.

■ Masking a memory

Unwanted memory channels can be masked (hidden). A masked memory channel cannot be selected for normal use. The contents of the masked memory, however, can be recalled by the following procedure.

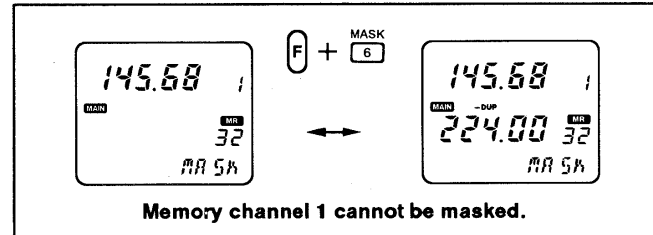

- ① Select the desired band with [**B** BAND].
- ② Select the memory channel to be masked:
 - Push [**M** MR] to select memory mode. ("MR" appears.)
 - Rotate the tuning dial to select the memory channel.
- ③ Push [**F**] + [**6** MASK] to mask the memory channel.
 - Memory channel 1 cannot be masked.

To recall the masked memory contents, select the desired memory channel; then, repeat step ③.

■ Calling up a call channel

Each band has an independent call channel to store a most-often-used frequency for quick recall.

- ① Select the desired band with [**B** BAND].
- ② Push [**C** CALL] to select the call channel.
 - "┌" appears.
 - If the repeater memory has been selected, push [**A** CLR] to exit in advance.
- ③ To return to the previous mode, push [**C** CALL].

■ Transferring call channel contents

- ① Select the desired band with [**B** BAND].
- ② Push [**C** CALL] to select the call channel.
 - "┌" appears.
 - If the repeater memory has been selected, push [**A** CLR] to exit in advance.
- ③ Push [**F**] + [**A** M▶V] for 1 sec.
 - "┌" disappears as VFO mode is automatically selected.
 - If the beep tone is ON, 3 beeps alert you that the call channel contents, including the duplex information, subaudible tone frequency, etc., are transferred.

■ Programming a call channel

As well as an operating frequency, duplex information and subaudible tone information (tone encoder or tone squelch ON/OFF and its frequency) can be programmed into the call channel.

- ① Select the desired band with [**B** BAND].
- ② Set the desired frequency in VFO mode:
 - Push [**A** CLR] to select VFO mode.
 - Set the desired frequency using the keyboard or tuning dial.
 - Set other data (e.g. offset frequency, duplex direction, subaudible tone encoder ON/OFF and its frequency), if required.
- ③ Push [**C** CALL] to select the call channel.
 - "┌" appears.
- ④ Push [**F**] + [**B** MW] for 1 sec. to program.
 - The frequency display changes to the programmed VFO contents.
 - If the beep tone is ON, 3 beeps alert you that the VFO contents, including the duplex information, subaudible tone frequency, etc., are programmed.

Scan types

Each band has 4 scan types with skip functions and 4 resume conditions to suit your needs. Scans on both bands can be operated separately or simultaneously.

FULL SCAN (p. 25)

Repeatedly scans all frequencies over the entire selected band.

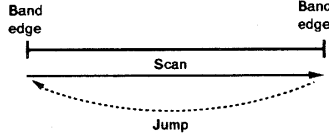

PROGRAMMED SCAN (p. 25)

Repeatedly scans between two user-programmed frequencies. Used for checking for frequencies within a specified range such as repeater output frequencies, etc.

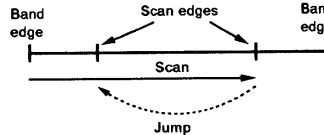

MEMORY SCAN (p. 28)

Repeatedly scans all memory channels, except masked channels, in sequence.

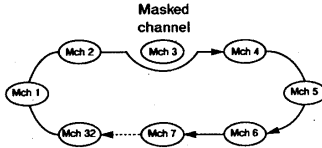

MEMORY SKIP SCAN (p. 28)

Repeatedly scans memory channels except skip and masked channels. Used for checking often-called channels and bypassing usually busy channels such as repeater frequencies.

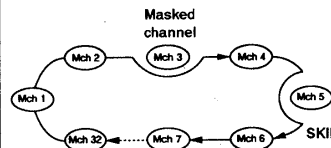

FREQUENCY SKIP FUNCTION (p. 27)

Skips unwanted frequencies that inconveniently stop scanning.

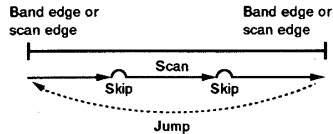

SCAN RESUME CONDITION (p. 29)

4 resume conditions are available: pause scan and 3 timer scans. When receiving a signal, pause scan pauses until the signal disappears; timer scans pause for 5, 10 or 15 sec.

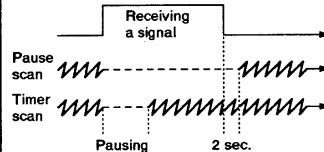

9 SCAN OPERATION

■ Full scan

- ① Select the desired band with [D BAND].
- ② Select VFO mode with [A CLR] if another mode has been selected on the selected band.
- ③ Turn the pager or code squelch function OFF when the function is in use. (pgs. 41–43)
- ④ Set the selected band's [SQL] to the point where noise is muted.
- ⑤ Push [⊗ ∇/SCAN] or [⊕ △/SCAN] for 1 sec. to start the scan.
 - To change the scanning direction, rotate the tuning dial.
- ⑥ To stop the scan, push [⊗ ∇/SCAN] or [⊕ △/SCAN].

■ Programmed scan

Scan edge frequencies should be programmed into the scan edge channels "PA" and "Pb" in advance. (p. 26)

- ① Select the desired band with [D BAND].
- ② Select VFO mode with [A CLR] if another mode has been selected on the selected band.
- ③ Turn the pager or code squelch function OFF when the function is in use. (pgs. 41–43)
- ④ Set the selected band's [SQL] to the point where noise is muted.
- ⑤ Push [F] + [⊗ ∇/SCAN] or [⊕ △/SCAN] to start the scan.
 - To change the scanning direction, rotate the tuning dial.
- ⑥ To stop the scan, push [⊗ ∇/SCAN] or [⊕ △/SCAN].

◇ Scan resume condition:

- When receiving a signal, scan resumes in one of the following ways:
 - after pausing 15 sec.
 - after pausing 10 sec.
 - after pausing 5 sec.
 - after the signal disappears.
- The scan resume condition can be selected in set mode. (p. 29)
- While scanning, rotating the tuning dial changes the scanning direction or skips a paused frequency.

■ Programming scan edges

Scan edges can be programmed in the same way as memory channels. Memory channels "PA" and "Pb" are available for programming scan edges.

- ① Select the desired band with [**D** BAND].
- ② Select the scan edge memory channel "PA" or "Pb":
 - Push [**B** MR] to select memory mode. ("MR" appears.)
 - Rotate the tuning dial to select the memory channel "PA" or "Pb."

- ③ Set the desired frequency in VFO mode:
 - Push [**A** CLR] to select VFO mode.
 - Rotate the tuning dial to set the desired frequency.
- ④ Push [**F**] + [**B** MW] for 1 sec.
 - If the beep tone is ON, 3 beeps alert you that the contents are programmed.
- ⑤ To program a frequency for the other scan edge memory channel "Pb" or "PA," repeat steps ②-④.
 - If the same frequency is programmed into "PA" and "Pb," programmed scan will not function.

[EXAMPLE]: Programming 145.30 MHz and 145.80 MHz for the 144 MHz band scan edges.

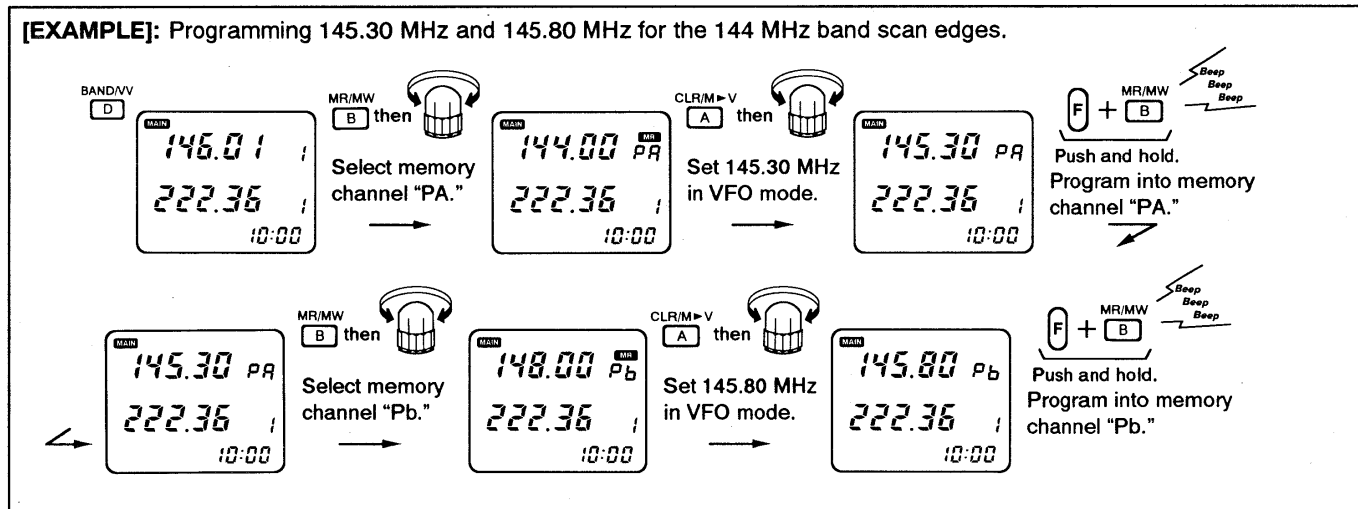

9 SCAN OPERATION

Frequency skip function

◆ Programming a skip frequency

Unwanted frequencies can be skipped and programmed as skip channels when full or programmed scan is pausing.

- ① Turn ON the frequency skip function of the desired band as described at right.
- ② Start full scan or programmed scan. (p. 25)
- ③ Push [F] + [Ⓜ MW] for 1 sec. to program the received frequency as a skip frequency.
 - The transceiver emits 3 beeps and the scan resumes.
 - Masked memory channels 32–11 are used in reverse sequence.
 - To scan the skip frequency after programming, cancel the skip information or mask the memory channel. (pgs. 22, 29)

◆ Programming a paused frequency

A paused frequency can be programmed into the selected memory channel when full or programmed scan is pausing.

- ① Turn OFF the frequency skip function of the desired band as described at right.
- ② Start full scan or programmed scan. (p. 25)
- ③ Push [F] + [Ⓜ MW] for 1 sec. to program the received frequency into the selected memory channel.
 - The transceiver emits 3 beeps and the scan resumes.

◆ Frequency skip function ON/OFF

The frequency skip function can be turned OFF in set mode. In this case, the frequencies will not be skipped even if skip information is programmed and “SKIP” will not blink during full scan or program scan.

USING SET MODE

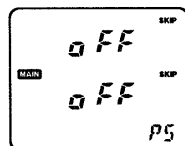

The frequency skip function of the 222 MHz band is OFF.

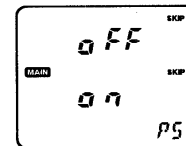

The frequency skip function of the 222 MHz band is ON.

- ① Push [F] + [Ⓜ SET] to enter set mode.
- ② Push [⊗ ▽] or [⊕ △] one or more times until “PS” appears in the display.
- ③ Rotate the tuning dial to turn the frequency skip function “on” or “off.”
 - When selecting “on,” the frequency skip function for full scan and programmed scan is turned ON.
- ④ Push [Ⓛ BAND] to set the other band condition, if desired.
- ⑤ Push [Ⓜ CLR] to exit set mode.

■ Memory scan

- ① Select the desired band with [D BAND].
- ② Push [B MR] to select memory mode.
 - "MR" appears.
 - If the call channel or repeater memory has been selected, push [A CLR] to exit.
- ③ Turn the pager or code squelch function OFF when the function is in use. (pgs. 41–43)
- ④ Set the selected band's [SQL] to the point where noise is muted.
- ⑤ Push [F ∇/SCAN] or [G △/SCAN] for 1 sec. to start the scan.
 - To change the scanning direction, rotate the tuning dial.
- ⑥ To stop the scan, push [F ∇/SCAN] or [G △/SCAN].

■ Memory skip scan

Memory skip scan repeatedly scans memory channels except skip and masked channels. Program the desired channel as a skip channel in advance. (p. 29)

- ① Select the desired band with [D BAND].
- ② Push [B MR] to select memory mode.
 - "MR" appears.
 - If the call channel or repeater memory has been selected, push [A CLR] to exit.
- ③ Turn the pager or code squelch function OFF when the function is in use. (pgs. 41–43)
- ④ Set the selected band's [SQL] to the point where noise is muted.
- ⑤ Push [F] + [F ∇/SCAN] or [G △/SCAN] to start the scan.
 - To change the scanning direction, rotate the tuning dial.
- ⑥ To stop the scan, push [F ∇/SCAN] or [G △/SCAN].

◇ Scan resume condition:

- When receiving a signal, scan resumes in one of the following ways:
 - after pausing 15 sec.
 - after pausing 10 sec.
 - after pausing 5 sec.
 - after the signal disappears.

- The scan resume condition can be selected in set mode. (p. 29)
- While scanning, rotating the tuning dial changes the scanning direction or skips a paused frequency.

9 SCAN OPERATION

■ Skip channel setting

Memory channels can be specified to be skipped for memory skip scan. This is useful to speedup the memory skip scan interval. These skip channels are also skipped during priority watch (memory skip scan watch). When the frequency skip function is ON, the frequencies of the channels are skipped during full scan or programmed scan (p. 27)

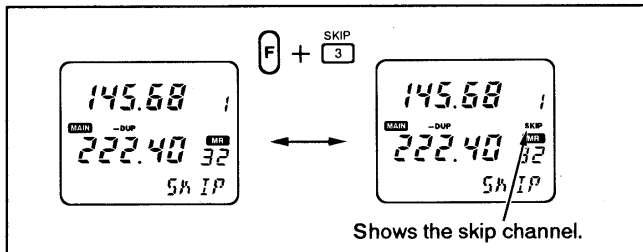

- ① Select the memory channel to be programmed as a skip channel:
 - Select the desired band with [BAND].
 - Push [MR]; then rotate the tuning dial or push [▽] or [△] to select the desired memory channel.
- ② Push [F] + [SKIP] to set the memory channel to the skip channel.
 - "SKIP" appears.
- ③ Repeat step ② to cancel a skip channel.
 - "SKIP" disappears.

■ Scan resume condition

USING SET MODE

The resume condition can be selected as a pause or timer scan. The resume condition is only used for scan and does not affect priority watch. (p. 30)

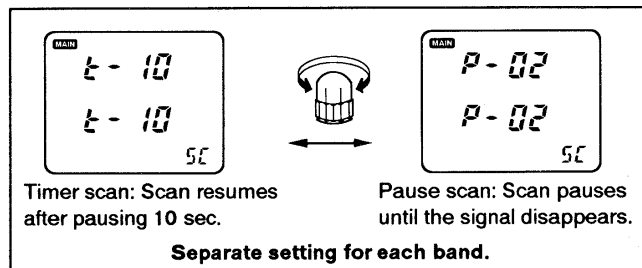

- ① Push [F] + [SET] to enter set mode.
- ② Push [▽] or [△] one or more times until "SC" appears in the display.
- ③ Rotate the tuning dial to set the desired timer.
 - "t-15" : Scan pauses 15 sec. while receiving a signal.
 - "t-10" : Scan pauses 10 sec. while receiving a signal.
 - "t-05" : Scan pauses 5 sec. while receiving a signal.
 - "P-02" : Scan pauses until the signal disappears and then resumes 2 sec. after that.
- ④ Push [BAND] to set the other band condition, if desired.
- ⑤ Push [CLR] to exit set mode.

Priority watch types

The priority watch checks for signals on a memory or call channel every 5 sec. while operating on a VFO frequency. The transceiver has 4 priority watch types to suit your needs. You can transmit on the VFO frequency while the priority watch operates.

When receiving a signal, priority watch pauses for 5 sec. (if the signal disappears within 5 sec., the watch resumes).

NOTE:

- Priority watch does not operate when:
 - The selected memory channel is a masked channel. (p. 22)
 - Pager or code squelch function is activated. (pgs. 41–43)
- If the pocket beep function is activated, the transceiver automatically selects the tone squelch function when priority watch starts.
- A memory channel with skip information can be watched.

Memory channel watch

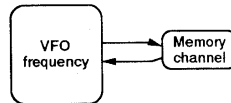

Memory scan watch

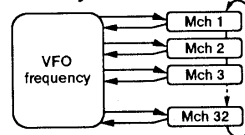

Memory skip scan watch

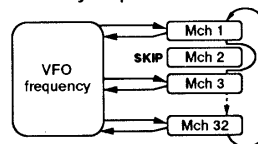

Call channel watch

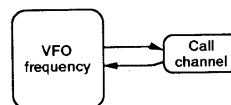

Priority watch operation

- ① Select the desired band with [D BAND].
- ② Select VFO mode; then, set an operating frequency.
- ③ Set the watching channel(s).

For memory channel watch:

Select the desired memory channel.

For memory scan watch:

Select memory mode; then, push [⊗ ∇/SCAN] or [⊕ △/SCAN] for 1 sec. to start the memory scan.

For memory skip scan watch:

Select memory mode; then, push [F] + [⊗ ∇/SCAN] or [⊕ △/SCAN] to start the memory skip scan.

For call channel watch:

Push [C CALL] to select the call channel.

- ④ Push [F] + [7 PRIO] to start the watch.
 - The transceiver receives the memory or call channel frequency every 5 sec.
 - While the watch is pausing, pushing [A CLR] resumes the watch manually.
- ⑤ Push [A CLR] while the display shows the VFO frequency to stop the watch.

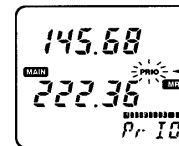

While pausing on a memory or call channel, "PRIO" blinks.

11 DTMF MEMORY

■ Programming a DTMF code

DTMF codes are used for autopatching, accessing repeaters, controlling other equipment, etc. The transceiver has 4 DTMF memory channels (t1–t4) for storage of often-used DTMF codes of up to 15 digits. The memory channels are for common use on both bands.

- ① Push [AI] until the AI function indicator blinks; then, rotate the tuning dial while continuing to push [AI] to select “DTMF.”
- ② Push [AI] momentarily to select DTMF memory mode.
- ③ Rotate the tuning dial to select the desired channel.
- ④ Push [F] + [Ⓢ SET]; then push the desired keys.
 - “E” stands for “*” and “F” stands for “#.”
 - Push [AI] and repeat this step when making a mistake.
- ⑤ Push [AI] to store the entered digits.
 - If 15 digits are input, this is not necessary.
- ⑥ Push [AI] or [PTT] to exit DTMF memory mode.
 - When [AI] is pushed, the transceiver emits the programmed DTMF code.

■ Transmitting a DTMF code

◇ Using a DTMF memory channel

- ① Push [AI] until the AI function indicator blinks; then, rotate the tuning dial while continuing to push [AI] to select “DTMF.”
- ② Push [AI] momentarily to select DTMF memory mode.
- ③ Rotate the tuning dial to select the desired channel.
- ④ Push [PTT] to exit DTMF memory mode.
 - Pushing [AI] also exits DTMF memory mode.
- ⑤ While pushing [PTT], push [AI] to transmit the selected DTMF code.
 - The function display shows the DTMF digits sent.

◇ Transmitting a DTMF code manually

- While pushing [PTT], push the key of the desired DTMF digit.
 - 1–0, A–D, * (E) and # (F) are available.

[EXAMPLE]: Programming “21ABC38” into DTMF memory channel “t4.”

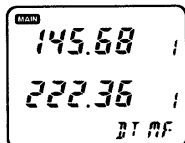

Select
“DTMF” in
advance.

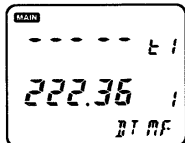

then

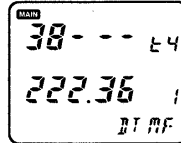
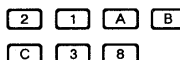
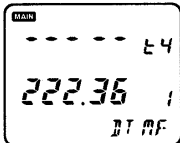

then



OPTIONAL WHISPER FUNCTION 12

■ General operation

The whisper function provides crossband full duplex communication, like a telephone, using a sub microphone on the optional battery pack, BP-131A or BP-132A.

NOTE: The whisper function can be activated, but your voice is not transmitted when the BP-130A or BP-157A is attached.

- ① Set the main band frequency as a transmit frequency.
- ② Set the sub band frequency as a receive frequency.
- ③ Push [F] + [RPT•M/WSPR] to activate the function.
 - "  " appears.
 - The transceiver automatically starts transmitting without pushing [PTT] and the TX indicator lights up in red.
 - Be sure the single band function is deactivated in advance. (p. 14)
- ④ Hold the transceiver as you would a telephone handset, then, speak into the microphone on the battery pack.
 - Received signals are emitted from the speaker at an attenuated level.
 - When the selected time-out time is passed after the whisper function starts, the whisper function is automatically cancelled by the time-out timer and returns to the normal operating condition. See section at right for details.
 - The tuning dial and switches cannot be used.
- ⑤ To cancel the function, push [RPT•M/WSPR].

■ Time-out timer setting



To prevent continuous transmission with the whisper function, the transceiver has a time-out timer. This timer turns the whisper function OFF 5, 15 or 30 min. after the function starts. This timer can be cancelled.

10 sec. before the time-out time passes, the transceiver emits a beep tone and counts down from TEL9 to TEL0. Pushing [RPT•M/WSPR] while counting down restarts the time-out timer.

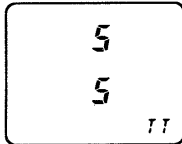
USING SET MODE



The display shows 5 min. timer is selected.

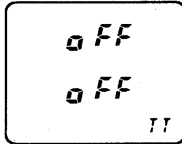

The display shows the time-out timer is cancelled.

- ① Push [F] + [ⓂSET] to enter set mode.
- ② Push [⊕▽] or [⊕△] one or more times until "TT" appears in the display.
- ③ Rotate the tuning dial to select the desired time-out time from 5, 15, 30 min. or turn the timer OFF.
- ④ Push [ⓂCLR] to exit set mode.

13 AI FUNCTION

■ What does AI in the transceiver do?

The AI in this transceiver has 2 important functions, "Learning Function" and "Automatic Order Selection."

• Learning function

The AI automatically assigns one of the transceiver functions, shown in the table at right, to the [AI] key after it is used. This function is then displayed in the function display and can be conveniently accessed by simply pushing the [AI] key. Because the transceiver 'learns' the last used function, this is called the "Learning Function."

In some cases, this automatic assignment of functions to the [AI] key may be inconvenient and for this reason the learning function can be turned OFF. The transceiver functions can then be manually assigned to the [AI] key.

• Automatic order selection

The AI changes the order in which functions can be selected via the [AI] key. To illustrate this, push and hold the [AI] key; then, rotate the tuning dial while continuing to push [AI]. Let's say you find the following order: [MASK], [SCAN], [PRIO], [DUP], etc. and you release the [AI] key when [PRIO] appears. The order changes to [PRIO], [MASK], [SCAN] and [DUP]. In other words, the AI keeps track of which function you use and when. It then orders them accordingly. This order is convenient when the learning function is OFF and you are manually assigning transceiver functions to the [AI] key.

FUNCTION INDICATOR	FUNCTIONS
15:00	Clock indication, timer functions
SCAN	Programmed scan, memory skip scan
TO NE	Tone encoder, tone squelch, pocket beep
DUP	Duplex set
PG r	Pager, code squelch
CODE	Code channel
Pr IO	Priority watch
SKIP	Skip channel setting
MSK	Masking a channel
SET	Set mode
BATT	Battery voltage indication
DTMF	DTMF memory channels

■ Learning function

When the learning function is ON:

[Example – to use the [AI] key as [F] + [Ⓜ MASK].]

- ① Select the desired band with [Ⓜ BAND].
- ② Select a memory channel to mask.
- ③ Push [F] + [Ⓜ MASK].
 - Confirm that "MASK" is indicated in the AI function indicator – this means the [MASK] is now assigned to the [AI] key.
- ④ Push [AI] again to recall the masked channel.
- ⑤ Select another memory channel to mask.
- ⑥ Push [AI] to mask the memory channel.

■ Learning function on/off

USING SET MODE

- ① Push [F] + [Ⓜ SET] to enter set mode.
- ② Push [⊗ ▽] or [⊕ △] one or more times until "AI" appears in the display.
- ③ Rotate the tuning dial to turn the learning function "on" or "oFF."
- When selecting "on," the learning function is turned ON.
- ④ Push [Ⓜ CLR] to exit set mode.

■ Manual assignment

While the learning function is ON, the [AI] key will activate your most recently used function: [F] + [X]. To manually assign functions to the [AI] key, the learning function must be OFF.

- ① Push and hold [AI] until the AI function indicator flashes.
- ② While continuing to push [AI], rotate the tuning dial to select the desired function.
 - The function order can be observed in the display as you rotate the tuning dial.
- ③ Release [AI] to select a function.
- ④ To activate the function you have assigned to the [AI] key, push [AI].

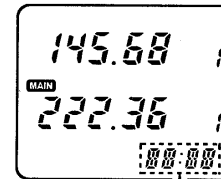

AI function indicator shows the assigned function.

NOTE: Pushing [F] + [Ⓜ CLOCK] assigns clock indication even when the learning function is OFF.

14 CLOCK AND TIMERS

■ Clock operation

◇ Setting the clock

- ① While pushing [F], push [9/CLOCK] twice to enter the time setting condition.
 - The hour digit blinks.
- ② Rotate the tuning dial to set the hour. (24-hour system)
- ③ Push [⊕/▽] or [⊕/△]; then rotate the tuning dial to set the minutes.
- ④ To start the clock, push [A/CLR].
 - The clock starts from 0 sec. and ":" blinks.
- ⑤ To cancel time setting and exit the time setting condition, push [PTT].

◇ Calling up the clock display

- Push [F] + [9/CLOCK] to call up the clock display.

TIME ERROR: ± 1 min./week

NOTE: CPU resetting clears the clock time. Set the time again in this case.

[EXAMPLE]: Setting the clock for 15:45.

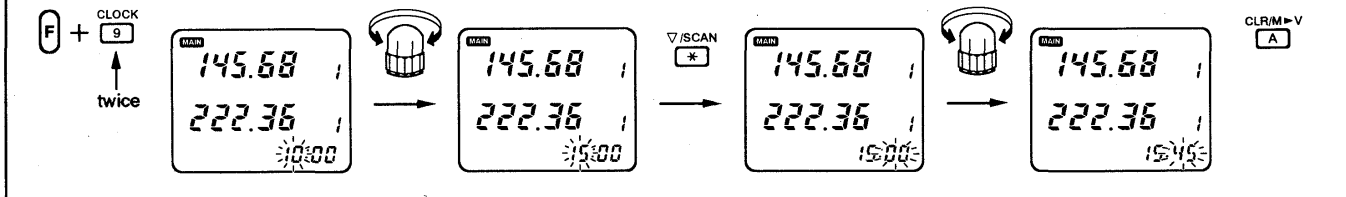

■ Timer mode

The transceiver has a built-in 24-hour clock with auto power-off, power-on timer and power-off timer functions.

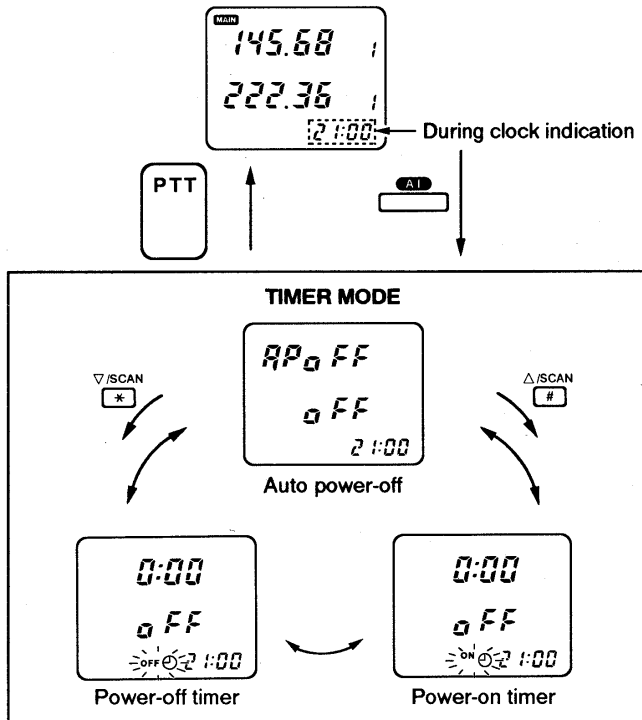

■ Auto power-off

The transceiver automatically turns OFF after a selected period in which no switch is pushed.

60 min., 40 min., 20 min. and OFF can be selected. The selected period is retained even when the transceiver is turned OFF by the auto power-off function. To cancel the function, select "oFF" in step ④ below.

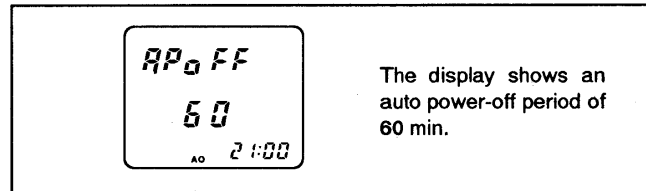

- ① Push [F] + [⑨CLOCK] to call up the clock display.
- ② Push [AI] to select timer mode.
- ③ Push [⊕▽] or [⊕△] until "APoFF" appears to select the auto power-off display.
- ④ Rotate the tuning dial to select the auto power-off period or turn the function OFF.
- ⑤ Push [PTT] to exit timer mode.
 - When the set period passes, the power is automatically turned OFF with 5 beeps.
 - "AO" appears while the auto power-off function is in use.

14 CLOCK AND TIMERS

■ Power-on timer

Use the power-on timer to suit your schedule and to save battery power.

- ① Select the desired band with [**B** BAND].
- ② Push [**A** CLR] to select VFO mode; then rotate the tuning dial to set the operating frequency.
- ③ Adjust the selected band's [VOL] to the desired audio level.
- ④ Push [F] + [**C** CLOCK] to call up the clock display.
- ⑤ Push [AI] to select timer mode.
- ⑥ Push [**+** ▽] or [**+** △] until "ON ⊖" blinks to select the power-on display.
- ⑦ Rotate the tuning dial clockwise to turn the power-on timer ON.
- ⑧ Set the power-on time:
 - Push [F] + [**S** SET]; then rotate the tuning dial to set the hour.
 - Push [**+** ▽] or [**+** △]; then rotate the tuning dial to set the minutes.
 - Push [**A** CLR] to enter the time.

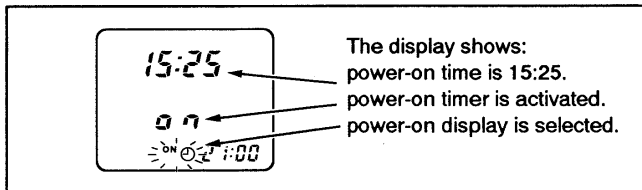

- ⑤ Push [POWER] for 1 sec. to turn the power OFF.
 - When the set time arrives, the power is automatically turned ON with 5 beeps and the power-on timer ON/OFF setting is set to OFF.

Cancel the power-on timer:

- ① Push [F] + [**C** CLOCK] to call up the clock display.
- ② Push [AI] to select timer mode.
- ③ Push [**+** ▽] or [**+** △] until "ON ⊖" blinks to select the power-on display.
- ④ Rotate the tuning dial counterclockwise to turn the power-on timer OFF.

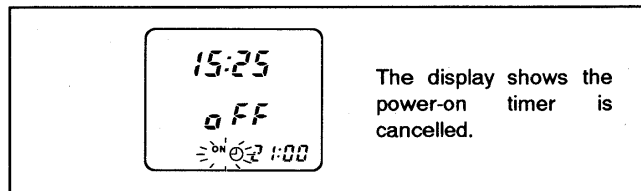

- ⑤ Push [PTT] to exit timer mode.

■ Power-off timer

Like the power-on timer, the power-off timer can be set to suit your schedule and conserve battery power. When the timer is activated, the timer indicator appears in the function display and the transceiver operates normally until the pre-set time at which it will turn OFF.

- ① Push [F] + [CLOCK] to call up the clock display.
- ② Push [A] to select timer mode.
- ③ Push [⊕▽] or [⊕△] until "OFF ☹" blinks to select the power-off display.
- ④ Rotate the tuning dial clockwise to turn the power-off timer ON.
- ⑤ Set the power-off time:
 - Push [F] + [SET]; then rotate the tuning dial to set the hour.
 - Push [⊕▽] or [⊕△]; then rotate the tuning dial to set the minutes.
 - Push [A CLR] to enter the time.

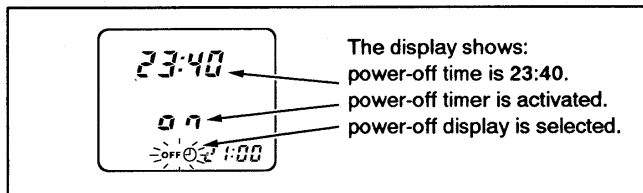

- ⑥ Push [PTT] to exit timer mode.
 - "OFF ☹" appears while the power-off timer is in use.
 - When the set time arrives, the power is automatically turned OFF with 5 beeps and the power-off timer ON/OFF setting is set to OFF.

Cancel the power-off timer:

- ① Push [F] + [CLOCK] to call up the clock display.
- ② Push [A] to select timer mode.
- ③ Push [⊕▽] or [⊕△] until "OFF ☹" blinks to select the power-off display.
- ④ Rotate the tuning dial counterclockwise to turn the power-off timer OFF.

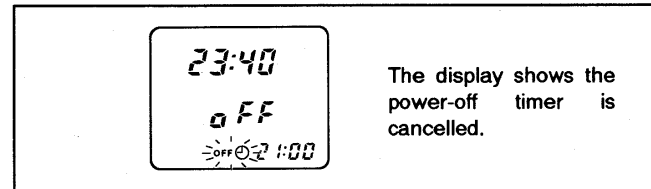

- ⑤ Push [PTT] to exit timer mode.

15 PAGER AND CODE SQUELCH

■ Pager function

This function uses DTMF codes for paging and can be used as a "message pager" to inform you of a caller's identity even if you leave the transceiver temporarily unattended.

Personal calls and group calls are available with the pager function. Personal calls use the receiving parties' ID code for calling. The receiving parties' display shows your ID code and other stations in the party know that you called. You can also call all stations in your group using the group call.

To use the pager function in your group, all stations need the pager function.

During pager operation, the power saver duty cycle becomes 1:1 if the power saver is activated.

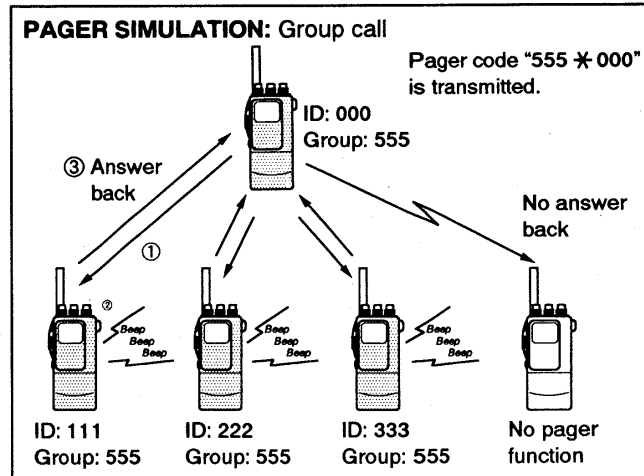
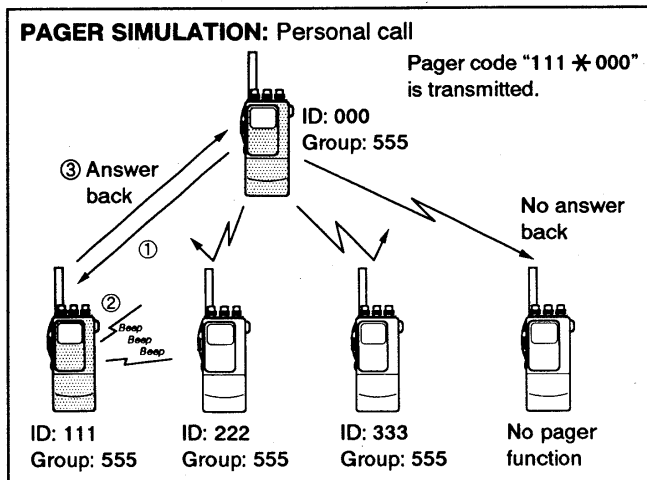

■ Code channel

• Before programming

The pager and code squelch functions require ID codes and a group code. These codes are 3-digit DTMF codes and must be written into the code channels before operation.

• Code channel assignment

ID or group code	Code channel number	"Receive accept" or "Receive inhibit"
Your ID code	C0	"Receive accept" only.
Other parties' ID code	C1–C5	"Receive inhibit" should be programmed in each channel.
Group code	One of C1–C5	"Receive accept" must be programmed.
Memory space*	CP	"Receive inhibit" only.

* Channel CP automatically memorizes an ID code when receiving a pager call. The contents in channel CP cannot be changed manually.

"RECEIVE ACCEPT" OR "RECEIVE INHIBIT"

Code channels C1–C5 should be effectively programmed as "Receive accept" or "Receive inhibit."

- "Receive accept" ("SKIP" indicator is not illuminated) accepts pager calls when the transceiver receives a signal with a code the same as that in the code channel.
- "Receive inhibit" ("SKIP" indicator is illuminated) rejects calls even when the transceiver receives a signal with a code the same as that in the code channel.

For example, the code channel that stores the group code should be programmed as "Receive accept." If the channel is programmed as "Receive inhibit," you cannot receive group calls.

The code channels that store other parties' ID codes for a transmit code should be programmed as "Receive inhibit." If the channels are programmed as "Receive accept," personal calls for parties other than yours will be received.

Code programming

- ① Select the desired band with [**BAND**].
 - Each band has separate code channels.
- ② Push [F] + [**CODE**] to select the code channel setting display.
- ③ Rotate the tuning dial to select the desired code channel, C0–C5.
 - Code channel CP cannot be used for programming.
- ④ Push the numeral keys to enter the desired 3-digit code.
 - Digits are automatically stored once the 3rd digit has been entered.
 - When an unwanted digit is entered, push [**CLR**] and enter the desired code from the beginning.
- ⑤ Push [F] + [**SKIP**] to set the channel for “receive inhibit” or “receive accept.”
 - When “receive inhibit” is set, “SKIP” is illuminated.
 - Code channel C0 cannot be set as “receive inhibit.”
 - See the previous page for “receive inhibit” or “receive accept” details.
- ⑥ Push [PTT] to exit the setting display.

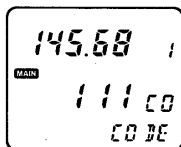

The display shows code channel C0 is programmed for 111.

Pager operation

◇ Calling a specific station

- ① Select the desired band with [**BAND**].
 - The pager function can be used on one band only.
- ② Set the operating frequency.
- ③ Push [F] + [**PGR/C SQL**] to turn the pager function ON.
 - “P” appears in place of the 100 MHz digit.
 - The tone squelch can be used together with the pager function. (p. 44)
- ④ Select the desired code channel:
 - Push [F] + [**CODE**].
 - Rotate the tuning dial to select the channel.
 - Push [PTT] to exit the setting display.
- ⑤ Push [PTT] to transmit the pager code.
- ⑥ Wait for an answer back.
 - When the transceiver receives an answer back code, the function display shows the other party’s ID or group code.
- ⑦ After confirming a connection, push [AI] to display the operating frequency.
 - **DO NOT** push numeral keys while code channels C0–C5 are indicated, or code channel contents are changed.
- ⑧ Push [F] + [**PGR/C SQL**] once to select the code squelch or twice to select the non-selective calling system.

◇ Waiting for a call from a specific station

- ① Select the desired band with [① BAND].
 - The pager function can be used on one band only.
- ② Set the operating frequency.
- ③ Push [F] + [② PGR/C SQL] to turn the pager function ON.
 - "P" appears in place of the 100 MHz digit.
 - The tone squelch can be used together with the pager function. (p. 44)
- ④ Wait for a call.
 - When receiving a call, other party's ID or group code appears and the receiving time blinks as shown at right.
 - **DO NOT** push numeral keys while code channels C0–C5 are indicated, or code channel contents are changed.
- ⑤ Push [PTT] to send an answer back call and display the operating frequency.
- ⑥ Push [F] + [② PGR/C SQL] once to select the code squelch or twice to select the non-selective calling system.

PERSONAL CALL

This display appears when you are called with your ID code and the calling station's ID code is 386.



Receiving time blinks.

GROUP CALL

This display appears when you are called with the group code, 123, and 123 has been programmed into code channel C5.



Receiving time blinks.

ERROR INFORMATION

When the transceiver receives an incomplete signal, "E" appears.

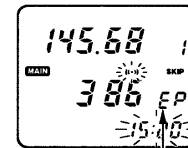

"E" appears.

Code squelch operation

The code squelch allows you communication with silent standby since you will only receive calls from stations which know your ID or group code.

The code squelch transmits a 3-digit code prior to voice transmission in order to open the receiving station's code squelch.

During code squelch operation, the power saver duty cycle becomes 1:1 if the power saver is activated.

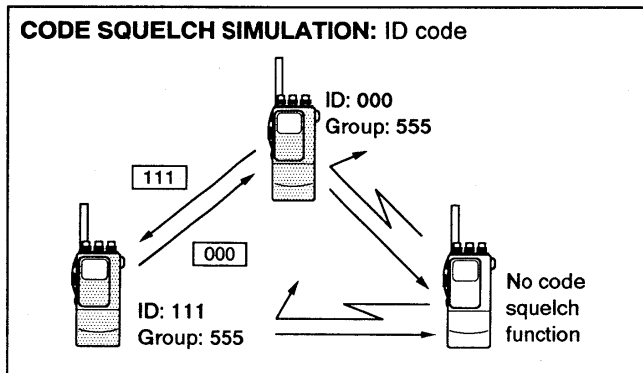

- ① Select the desired band with [Ⓛ BAND].
 - The code squelch can be used on one band only.
- ② Set the operating frequency.
- ③ Push [F] + [Ⓜ PGR/C SQL] twice to turn the code squelch ON.
 - "C" appears in place of the 100 MHz digit.
 - The tone squelch can be used together with the pager function. (p. 44)
- ④ Select the desired code channel:
 - Push [F] + [Ⓟ CODE].
 - Rotate the tuning dial to select the channel.
 - Push [PTT] to exit the setting display.
- ⑤ Operate the transceiver in the normal way (push [PTT] to transmit; release [PTT] to receive).
 - Prior to voice transmission, a 3-digit transmit code is sent each time [PTT] is pushed in order to open the receiving station's code squelch.
- ⑥ To cancel the code squelch, push [F] + [Ⓜ PGR/C SQL].
 - "C" returns to indicate the 100 MHz digit.

■ Pocket beep operation

This function uses subaudible tones for calling and can be used as a “common pager” to inform you that someone has called while you were away from the transceiver.

◇ Waiting for a call from a specific station

- ① Select the desired band with [**Ⓢ** BAND].
- ② Set the operating frequency.
- ③ Program the subaudible tone frequency in set mode.
 - See p. 18 for programming details.
- ④ Push [F] + [**①** T/T SQL] several times until “T SQL ((•))” appears on the function display.
 - Turn OFF the pager or code squelch to activate the pocket beep. (pgs. 41–43) The pocket beep cannot be used in combination with the pager or code squelch.
- ⑤ When a signal with the correct tone is received, the transceiver emits beep tones for 30 sec. and flashes “((•)).”
- ⑥ Push [PTT] to answer or push [**Ⓐ** CLR] to stop the beeps and flashing.
 - Tone squelch is automatically selected.

◇ Calling a waiting station using pocket beep

A subaudible tone matched with the station's tone frequency is necessary. Use the tone squelch at right or a subaudible tone encoder (p. 17).

■ Tone squelch operation

The tone squelch opens only when receiving a signal with the same pre-programmed subaudible tone. You can silently wait for a call from group members using the same tone. This function can be activated on both bands with separate tone frequencies simultaneously.

- ① Select the desired band with [**Ⓢ** BAND].
- ② Set the operating frequency.
- ③ Program the subaudible tone frequency in set mode.
 - See p. 18 for programming details.
- ④ Push [F] + [**①** T/T SQL] several times until “T SQL” appears on the function display.
 - The code squelch can be used together with the tone squelch. (p. 43)
- ⑤ When the received signal includes the correct tone, the squelch opens and the signal can be heard.
 - When the received signal includes an incorrect tone, the squelch does not open. Only the green indicator lights up.
 - To open the main band squelch manually, push and hold [MONI].
- ⑥ Operate the transceiver in the normal way (push [PTT] to transmit; release [PTT] to receive).
- ⑦ To cancel the tone squelch, push [F] + [**①** T/T SQL] several times until “T” or “T SQL” disappears from the function display.

17 OTHER FUNCTIONS

Power saver

USING SET MODE

The power saver function reduces the current drain to conserve battery power while waiting on a frequency. The power saver duty cycle can be set to 1:4, 1:16 or OFF. Setting it to 1:16 conserves the most power. For packet operation, the power saver should be turned OFF to receive reliable packet data.

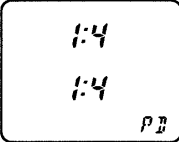
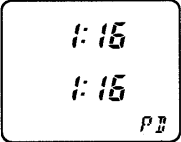
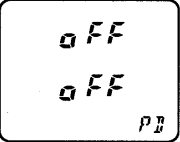
		
Standby 125 msec. Circuit off 500 msec.	125 msec. 2 sec.	Power saver is turned OFF.
Common setting for both bands.		

- ① Push [F] + [Ⓢ SET] to enter set mode.
- ② Push [⊕ ▽] or [⊕ △] one or more times until "PD" appears in the display.
- ③ Rotate the tuning dial to select the desired duty cycle or to turn the function OFF.
- ④ Push [Ⓐ CLR] to exit set mode.

NOTE: When the duty cycle is set to 1:16, signals may be clipped up to a 2 sec. max.

Battery voltage indication

The transceiver has a battery capacity indicator that indicates the connected battery voltage as a %. This indicator is designed to show dry cell battery consumption in the optional BP-130A* BATTERY CASE. When using the BP-131A, BP-132A or BP-157A, voltage is indicated; however, it is not useful. This is because once the voltage goes down, it will decrease rapidly as a result of the Ni-Cd battery characteristics.

- ① While pushing [AI], rotate the tuning dial to select "BATT"; then, release [AI] to display the battery capacity indicator.
- ② The indicator shows the current voltage.
 - "B100" means the same voltage as the starting voltage.
 - "B 80" means the voltage is at 80% of the starting voltage.
- ③ When the indicator shows "B 60" to "B 50," the dry cell batteries in the BP-130A cannot activate the transmitter circuitry.

◆ Resetting the indicator

When placing new dry cell batteries in the battery case, the indicator should be reset.

- ① Select the battery capacity indicator as above.
- ② Push [F] + [AI] to reset the reference voltage.
 - The indicator shows "B 100" (100% voltage).

■ PTT lock function USING SET MODE

The PTT lock function locks the PTT switch electronically to prevent accidental transmission. The optional whisper function can be used even when the PTT lock function is in use.

- ① Push [F] + [ⓈSET] to enter set mode.
- ② Push [⊕▽] or [⊕△] one or more times until "PT" appears in the display.
- ③ Rotate the tuning dial to turn the PTT lock function ON ("PL") or OFF ("P").
- ④ Push [ⒶCLR] to exit set mode.

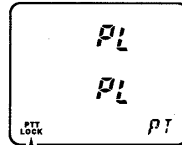

PTT lock indicator appears while the function is in use.

■ Beep tone on/off USING SET MODE

The beep tone which sounds each time a switch is pushed can be turned ON or OFF, as desired.

- ① Push [F] + [ⓈSET] to enter set mode.
- ② Push [⊕▽] or [⊕△] one or more times until "BE" appears in the display.
- ③ Rotate the tuning dial to select the beep tone "on" or "oFF."
- ④ Push [ⒶCLR] to exit set mode.

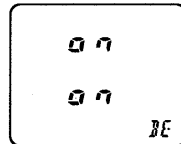

■ Receive indicator on/off USING SET MODE

The receive indicator can be turned ON or OFF. Turn it OFF when you want to conserve battery power.

- ① Push [F] + [ⓈSET] to enter set mode.
- ② Push [⊕▽] or [⊕△] one or more times until "BL" appears in the display.
- ③ Rotate the tuning dial to select the receive indicator "on" or "oFF."
- ④ Push [ⒶCLR] to exit set mode.

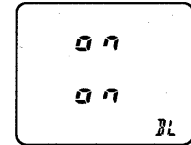

■ LCD contrast USING SET MODE

The LCD (Liquid Crystal Display) contrast can be selected from 2 levels (1 and 2) for your preference. Select a suitable level depending on the ambient light.

- ① Push [F] + [ⓈSET] to enter set mode.
- ② Push [⊕▽] or [⊕△] one or more times until "LC" appears in the display.
- ③ Rotate the tuning dial to select the desired contrast.
- ④ Push [ⒶCLR] to exit set mode.

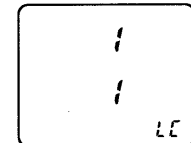

• Level 2 is higher contrast.

17 OTHER FUNCTIONS

External speaker USING SET MODE selection

When an external speaker is connected, audio of each band can be selected to external equipment or the internal speaker.

144 MHz audio: External External Internal
222 MHz audio: External Internal Internal

Separate setting for each bands.

- ① Push [F] + [ⓈSET] to enter set mode.
- ② Push [⊗▽] or [⊕△] one or more times until “SP” appears in the display.
- ③ Push [ⓈBAND] to select the desired band.
- ④ Rotate the tuning dial to set the selected band audio for external equipment (“out”) or internal speaker (“in”).
- ⑤ Push [ⒶCLR] to exit set mode.

NOTE: Even if “out” is selected, audio is emitted via the internal speaker when the [SP] jack has no connection.

Partial resetting

If you want to initialize the operating condition (VFO frequency, VFO settings, set mode contents) without clearing the memory contents, repeater memories, clock or timer, a partial resetting function is available for the transceiver.

- ① Turn power OFF.
- ② While pushing [ⒶCLR], push and hold [POWER] for 1 sec. to partially reset the transceiver.

After partial resetting, the transceiver’s condition is as follows:

OPERATING CONDITION or MEMORY CONTENTS	AFTER PARTIAL RESETTING
Operating mode	VFO mode
VFO frequency and VFO settings (tuning steps, subaudible tone and offset frequencies)	Initialized
Memory and call channel contents	Unchanged
Set mode contents	Initialized
Clock and timer settings	Unchanged
Pager, code squelch and tone squelch	Cancelled
V by V function	Cancelled

■ Optional HM-75A functions

When using an optional HM-75A with the transceiver, the switches on the HM-75A function as follows:

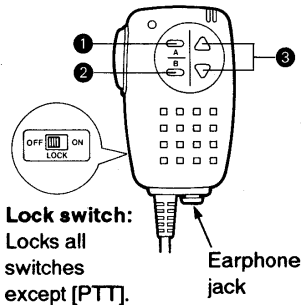

① A SWITCH

Changes the main band or activates a function assigned in the AI function indicator. (See at right.)

② B SWITCH

Changes mode between VFO and memory.

③ △/▽ SWITCHES

- Change the frequency in the selected tuning steps in VFO mode.
- Change memory channel in memory mode.
- Start programmed scan or memory skip scan when pushed for 1 sec.

◇ Setting the [A] switch function

The [A] switch function can be set from [AI] or [Ⓢ BAND] as described below:

SETTING THE [A] SWITCH AS [AI]

- ① Turn power OFF.
- ② While pushing [F] and [AI], turn power ON.
 - After setting, pushing [A] activates the function allocated to the AI function indicator.

SETTING THE [A] SWITCH AS [Ⓢ BAND] (default setting)

- ① Turn power OFF.
- ② While pushing [F] and [Ⓢ BAND], turn power ON.
 - After setting, pushing [A] toggles the main band between the 144 MHz and 222 MHz bands.

18 MODE CONSTRUCTION CHART

Although the following chart refers only to the 144 MHz band, the transceiver has the same mode arrangement in the 222 MHz band.

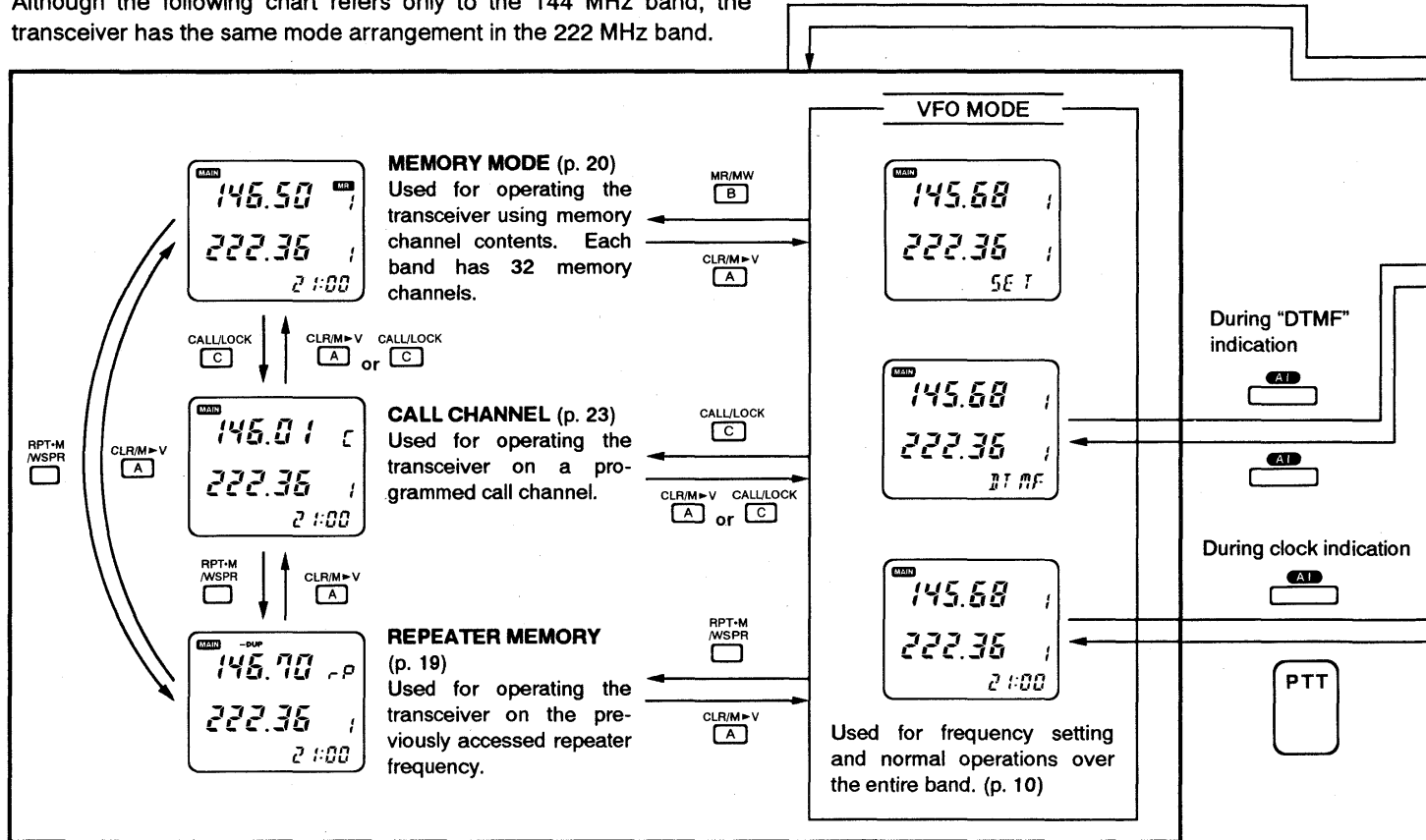

MODE CONSTRUCTION CHART 18

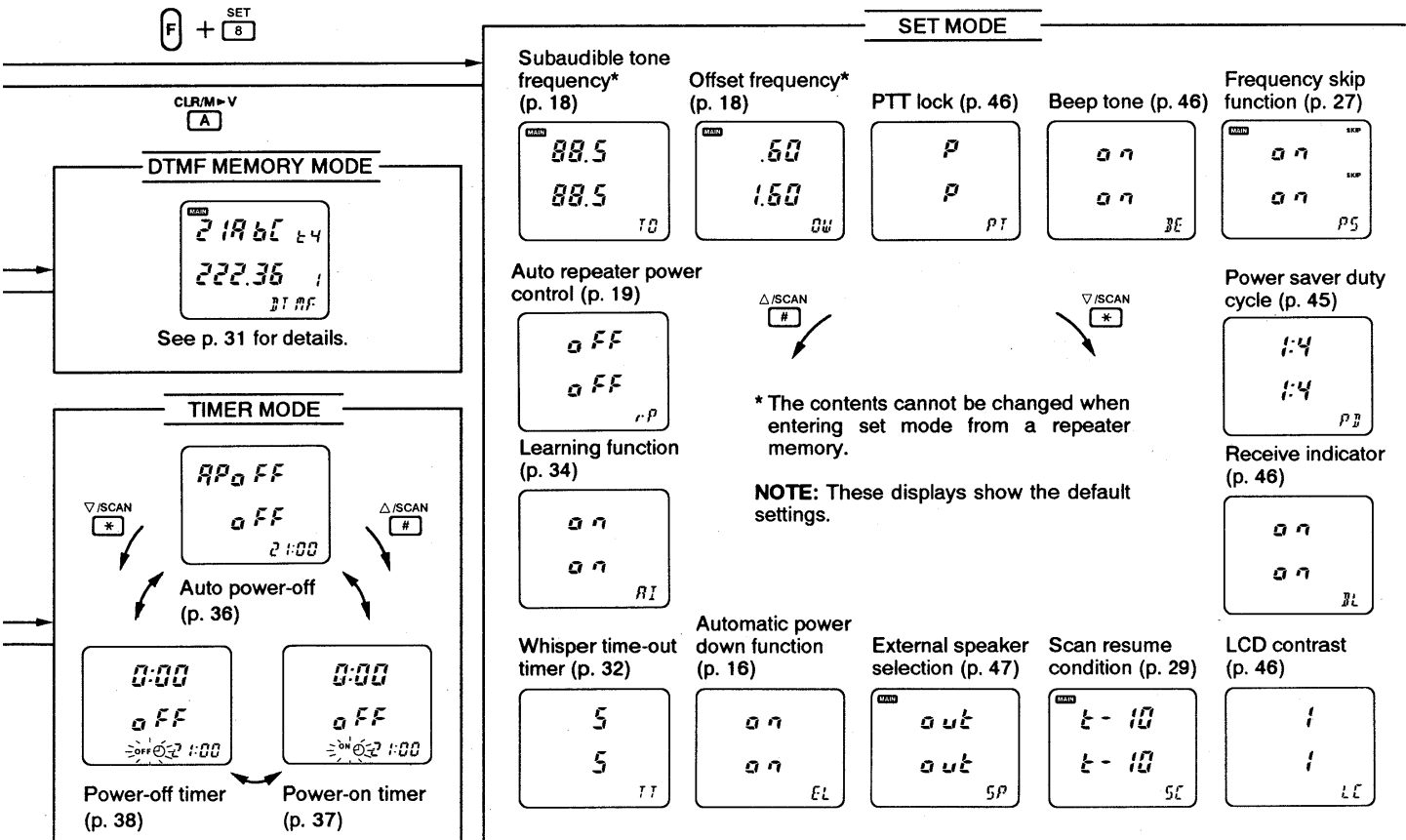

19 TROUBLESHOOTING

If your transceiver seems to be malfunctioning, please check the following points before sending it to a service center.

PROBLEM	POSSIBLE CAUSE	SOLUTION	REF.
<ul style="list-style-type: none"> No power comes on. 	<ul style="list-style-type: none"> The battery is exhausted. (A slight current flows in the circuits even when the power is OFF.) Poor plug connection to the external DC power cable. 	<ul style="list-style-type: none"> Charge the battery pack or place new dry cell batteries in the battery case. (Remove the battery pack if you will not be using the transceiver for a long time.) Check the connector or remove and replace the cable. 	<p>pgs. i, 8</p> <p>—</p>
<ul style="list-style-type: none"> Power cannot be turned OFF. 	<ul style="list-style-type: none"> The battery became exhausted during operation. 	<ul style="list-style-type: none"> Charge the battery pack or place new dry cell batteries in the battery case, then, turn the power OFF. 	<p>pgs. i, 8</p>
<ul style="list-style-type: none"> No sound comes from the speaker. 	<ul style="list-style-type: none"> [SQL] is turned too far clockwise. An external speaker or earphone is connected. Pager or code squelch is activated. Pocket beep or tone squelch is activated. 	<ul style="list-style-type: none"> Rotate [SQL] counterclockwise. Unplug the speaker or earphone. Push [F] + [②PGR/C SQL] once or twice to turn the function OFF. Push [F] + [①T/T SQL] once or twice to turn the function OFF. 	<p>p. 14</p> <p>—</p> <p>pgs. 41–43</p> <p>p. 44</p>
<ul style="list-style-type: none"> Transmitting is impossible. 	<ul style="list-style-type: none"> The battery is exhausted. 	<ul style="list-style-type: none"> Charge the battery pack or place new dry cell batteries in the battery case. 	<p>pgs. i, 8</p>
<ul style="list-style-type: none"> Frequency cannot be set. 	<ul style="list-style-type: none"> Memory mode, call channel or repeater memory is selected. The lock function is activated. 	<ul style="list-style-type: none"> Push [ⒶCLR] one or more times to select VFO mode. Push [F] + [ⓄLOCK] to deactivate the lock function. 	<p>p. 10</p> <p>p. 11</p>
<ul style="list-style-type: none"> Scan cannot be activated. 	<ul style="list-style-type: none"> The squelch is open. 	<ul style="list-style-type: none"> Rotate the [SQL] control clockwise until noise disappears. 	<p>pgs. 25, 28</p>
<ul style="list-style-type: none"> The contents of the memories are erased. 	<ul style="list-style-type: none"> The internal memory backup battery is exhausted because no charging has been performed for a long time. 	<ul style="list-style-type: none"> Charge the battery pack or place new dry cell batteries in the battery case. The memory backup battery is simultaneously charged. 	<p>pgs. i, 8</p>

SPECIFICATIONS 20

			144 MHz	222 MHz	
GENERAL	Frequency coverage (Guaranteed range of the 144 MHz band is 144–148 MHz.)		Tx: 144–148 MHz Rx: 136–174 MHz	222–225 MHz	
	Mode		FM (F3E)		
	Frequency stability		± 5 ppm (0 °C to +50 °C; +32 °F to +122 °F)		
	Tuning steps		5, 10, 12.5, 15, 20, 25, 30 or 50 kHz		
	Antenna impedance		50 Ω (nominal)		
	Usable battery pack/case		BP-130A–BP-132A, BP-157A		
	External DC power		6–16 V DC (negative ground)		
	Current drain (at 13.5 V, typical)	Tx	High	1.5 A	1.5 A
			Low 1	600 mA	600 mA
		1 band Rx	Rated audio	150 mA	150 mA
			Power saved	15 mA (average)	15 mA (average)
	2 bands Rx	Rated audio	200 mA		
		Power saved	30 mA (average)		
	Usable temperature range		–10 °C to +60 °C; +14 °F to +140 °F		
	Dimensions (with BP-157A) (projections not included)		57(W) × 125(H) × 35(D) mm; 2.2(W) × 4.9(H) × 1.4(D) in		
	Weight (with BP-157A and antenna)		390 g; 13.8 oz		

			144 MHz	222 MHz
TRANSMITTER	Output power* (at 13.5 V)		5 W, 3.5 W, 1.5 W, 500 mW, 20 mW (selectable)	
	Modulation system		Variable reactance frequency modulation	
	Max. freq. deviation*		± 5 kHz	
	Spurious emissions*		Less than –60 dB	
Microphone impedance		2 kΩ		
RECEIVER	Receive system		Double-conversion superheterodyne	
	Intermediate frequencies	1st	43.1 MHz	45.15 MHz
		2nd	455 kHz	
	Sensitivity* (for 12 dB SINAD)		Less than 0.16 μV	
	Squelch sensitivity		Less than 0.13 μV (at threshold)	
	Selectivity		More than 15 kHz/–6 dB Less than 30 kHz/–60 dB	
	Spurious and image rejection ratio*		More than 60 dB (More than 45 dB at IF/2)	
Audio output power* (at 13.5 V)		More than 200 mW (at 10% distortion with an 8 Ω load)		
Audio output impedance		8 Ω		

* Specifications guaranteed at a transceiver temperature of +25°C (+77°F).

All stated specifications are subject to change without notice or obligation.

21 OPTIONS

◇ Battery packs and chargers

BATTERY PACK	HEIGHT	VOLTAGE	CAPACITY	CARRYING CASE	SUB MICROPHONE
BP-130A	50 mm, 2.0 in	Battery case R6 (AA) size × 6		LC-105A	Not included
BP-131A	50 mm, 2.0 in	7.2 V	900 mAh	LC-105A	Included
BP-132A	78.2 mm, 3.1 in	12.0 V	600 mAh	LC-106A	Included
BP-157A	50 mm, 2.0 in	7.2 V	900 mAh	LC-105A	Not included

CP-13/L

CIGARETTE LIGHTER CABLE WITH NOISE FILTER
For operation and charging with a 12 V cigarette lighter socket.

OPC-288/L

DC POWER CABLE
For operation and charging with an external power supply.

BC-77A/E/D/V

WALL CHARGER
Regularly charges a battery pack.

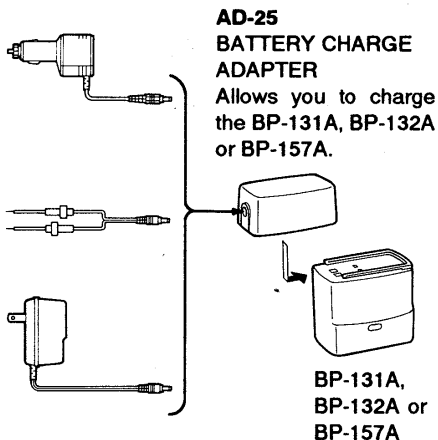

BC-79 DESKTOP CHARGER + AD-28 BATTERY PACK ADAPTER

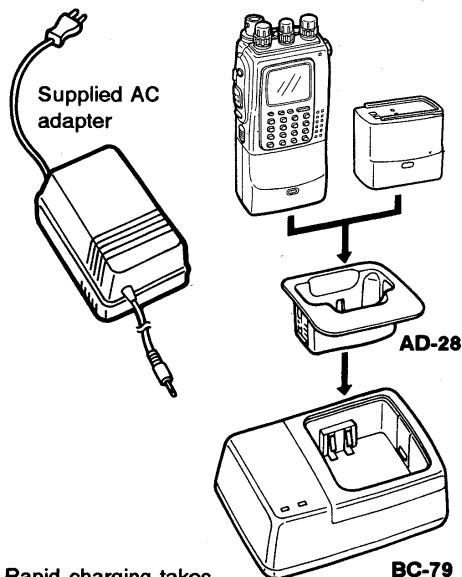

- Rapid charging takes 1–1.5 hrs.
- An AC adapter is packed with the BC-79.
- The CP-13/L or OPC-288/L can be used instead of the supplied AC adapter.

NOTE: Audio output from the [SP] jack can be selected in set mode. When external equipment is connected, only the selected band audio can be heard. See p. 47 for details.

◆ **Speaker-microphones**

HM-9

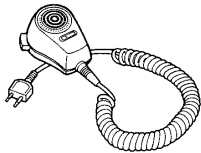

HM-46

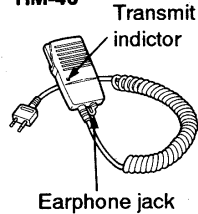

HM-54

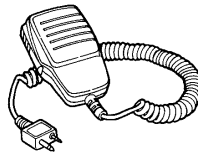

HM-55A

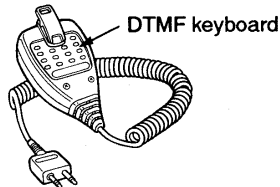

HM-75A

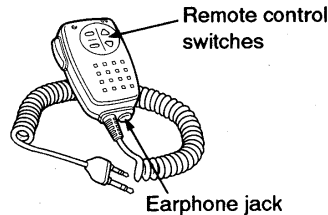

HM-30 MOUNTING BRACKET

When using the bracket hanger

When using no bracket hanger

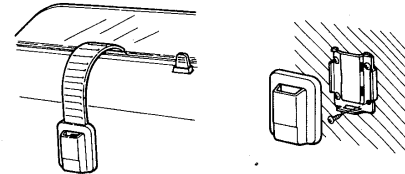

HS-51 HEADSET

- PTT switch
- VOX
- One-touch PTT for hands-free operation

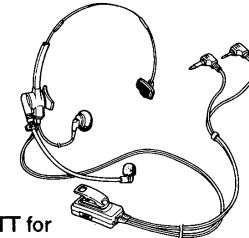

FA-B2125A DUAL BAND FLEXIBLE ANTENNA

The same type as supplied with the transceiver.

SP-13 EARPHONE

Provides clear receive audio in noisy environments.

Count on us!

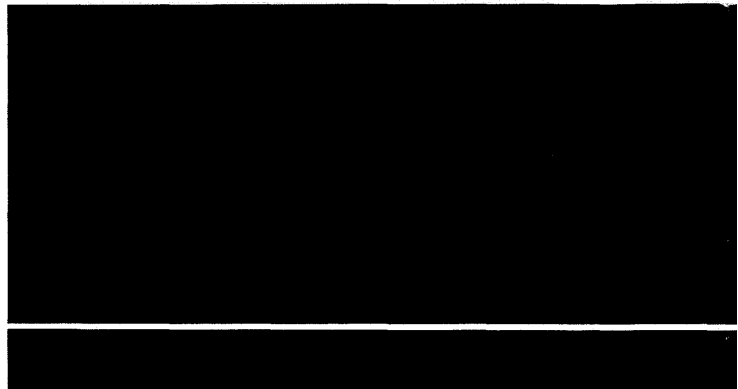

A-5258S-1US
Printed in Japan
Copyright © 1993 by Icom Inc.

Icom Inc.
6-9-16, Kamihigashi, Hirano-ku, Osaka 547, Japan