

ICOM

INSTRUCTION MANUAL

DUAL BAND FM TRANSCEIVER

IC-W31A IC-W31E

This device complies with Part 15 of the FCC rules. Operation is subject to the following two conditions: (1) This device may not cause harmful interference, and (2) this device must accept any interference received, including interference that may cause undesired operation.

Icom Inc.

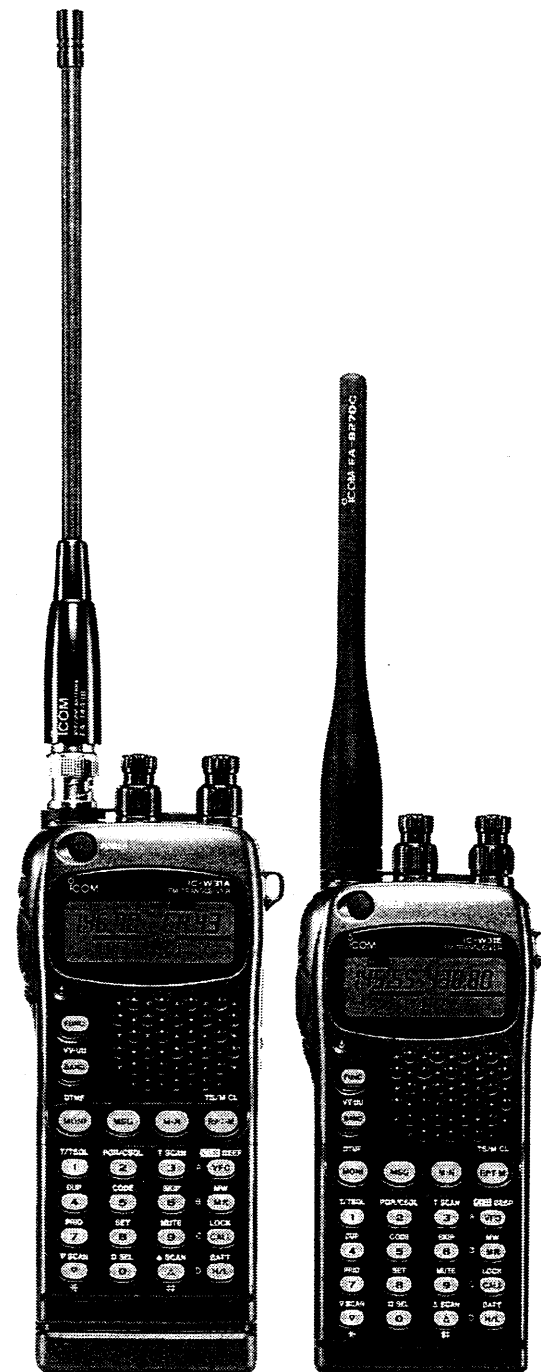

IMPORTANT

READ ALL INSTRUCTIONS carefully and completely before using the transceiver.

SAVE THIS INSTRUCTION MANUAL—This instruction manual contains important operating instructions for the IC-W31A and IC-W31E.

EXPLICIT DEFINITIONS

CAUTION: Equipment damage may occur.

NOTE: If disregarded, inconvenience only. No risk or personal injury, fire or electric shock.

 This manual describes the UT-94 TONE SQUELCH UNIT as an option. However, it is standard in the U.S.A. version.

CAUTIONS

⚠ NEVER connect the transceiver to an AC outlet or to a power source of more than 16 V DC. Such a connection may pose a fire hazard.

NEVER connect the transceiver to a power source using reverse polarity without a fuse (or with a more than 5 A fuse). This connection will ruin the transceiver.

NEVER attempt to charge alkaline or dry cell batteries. Beware that external DC power connections will charge batteries inside the battery case. This will damage not only the battery case but also the transceiver.

AVOID using or placing the transceiver in direct sunlight or in areas with temperatures below -10°C ($+14^{\circ}\text{F}$) or above $+60^{\circ}\text{C}$ ($+140^{\circ}\text{F}$).

BE CAREFUL! When transmitting for a long time at high output power, the rear panel will become hot.

The use of non-Icom battery packs/chargers may impair transceiver performance and invalidate the warranty.

Even when the transceiver power is OFF, a slight current still flows in the circuits. Remove the battery pack or case from the transceiver when not using it for a long time. Otherwise, the battery pack or installed dry cell batteries will become exhausted.

UNPACKING

Accessories included with the transceiver:

| | Qty. |
|---|-------------|
| ① Antenna..... | 1 |
| ② Handstrap..... | 1 |
| ③ Battery pack (BP-171 or BP-180) or battery case (BP-170) attached to the transceiver..... | 1 |
| ④ Belt clip and screws..... | 1 set |
| ⑤ Wall charger*..... | 1 |

*Not supplied with battery case versions.

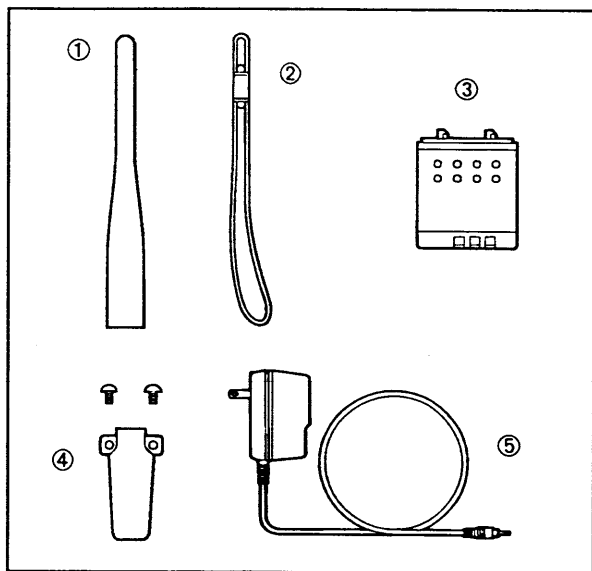

GETTING STARTED

① Charge the battery pack or install alkaline batteries into the battery case (pgs. 10, 11).

② Turn power ON.

- Push and hold [POWER] for 2 sec.

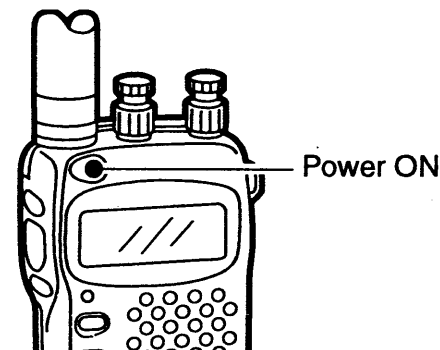

③ Set the audio level by rotating [DIAL].

④ Set the frequency — while holding [D/M], rotate [DIAL].

- The priority of the [DIAL] function can be selected as “volume” or “tuning dial” in set mode (p. 42).

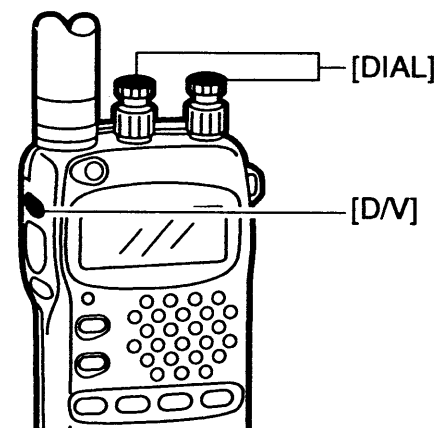

TABLE OF CONTENTS

| | | | |
|---|----------------|--|----------------|
| CAUTIONS | i | 4 BASIC OPERATION..... | 17 – 19 |
| UNPACKING..... | ii | ■ Receive and transmit | 17 |
| GETTING STARTED | ii | ■ U by U and V by V functions | 19 |
| TABLE OF CONTENTS | iii | ■ Single band function | 19 |
| 1 PANEL DESCRIPTION | 1 – 8 | ■ Beep tones on/off..... | 19 |
| ■ Switches, controls, keys and connectors | 1 | 5 REPEATER OPERATION..... | 20 – 22 |
| ■ Function display | 7 | ■ General | 20 |
| 2 BATTERY PACKS AND ACCESSORIES..... | 9 – 12 | ■ Subaudible tones | 21 |
| ■ Battery pack charging | 9 | ■ Offset frequency..... | 21 |
| ■ Charging precautions..... | 9 | ■ Repeater memory | 22 |
| ■ About the battery pack..... | 9 | ■ Auto repeater function..... | 22 |
| ■ Charging connections | 10 | 6 MEMORY/CALL PROGRAMMING | 23 – 26 |
| ■ Battery case | 11 | ■ General | 23 |
| ■ Accessory attachment..... | 12 | ■ Programming during selection | 23 |
| 3 FREQUENCY AND CHANNEL SETTING | 13 – 16 | ■ Programming after selection | 24 |
| ■ VFO and memory/call channels..... | 13 | ■ Memory edit (transferring)..... | 24 |
| ■ Band selection | 13 | ■ Memory clear | 25 |
| ■ Lock function..... | 13 | ■ Memory names | 25 |
| ■ Frequency or channel selection via the keypad | 14 | 7 DTMF MEMORY | 27 – 28 |
| ■ Using the tuning dial | 15 | ■ Programming a DTMF code..... | 27 |
| ■ Using the Δ/∇ keys | 15 | ■ Transmitting a DTMF code..... | 27 |
| ■ Setting tuning dial increments..... | 16 | ■ Confirming a DTMF channel's contents | 28 |
| | | ■ DTMF transmission speed..... | 28 |

| | | | | |
|-----------|--|----------------|--|--|
| 8 | SCAN OPERATION..... | 29 – 31 | | |
| | ■ Scan types | 29 | | |
| | ■ Full/programmed scan | 30 | | |
| | ■ Memory (skip) scan..... | 30 | | |
| | ■ Skip channel setting..... | 31 | | |
| | ■ Scan resume condition | 31 | | |
| 9 | PRIORITY WATCH..... | 32 | | |
| | ■ Priority watch types..... | 32 | | |
| | ■ Priority watch operation | 32 | | |
| 10 | PAGER AND CODE SQUELCH..... | 33 – 36 | | |
| | ■ Pager function | 33 | | |
| | ■ Code programming | 33 | | |
| | ■ Pager operation | 35 | | |
| | ■ Code squelch | 36 | | |
| 11 | MESSAGE FUNCTION | 37 – 38 | | |
| | ■ General | 37 | | |
| | ■ Message programming | 37 | | |
| | ■ Operation | 38 | | |
| 12 | SUBAUDIBLE TONE OPERATION..... | 39 – 40 | | |
| | ■ General | 39 | | |
| | ■ Tone squelch operation..... | 39 | | |
| | ■ Tone scan..... | 40 | | |
| | ■ Pocket beep operation | 40 | | |
| 13 | OTHER FUNCTIONS | 41 – 44 | | |
| | ■ Battery voltage indication..... | 41 | | |
| | ■ Power saver | 41 | | |
| | ■ Auto power-off function | 42 | | |
| | ■ Dial function | 42 | | |
| | ■ LCD contrast..... | 43 | | |
| | ■ PTT lock function | 43 | | |
| | ■ Optional HM-75A functions..... | 44 | | |
| | ■ Partial reset..... | 44 | | |
| | ■ All reset..... | 44 | | |
| 14 | OPTIONAL UT-94 TONE SQUELCH UNIT..... | 45 | | |
| | ■ Optional UT-94 installation | 45 | | |
| 15 | TROUBLESHOOTING | 46 | | |
| 16 | MODE ARRANGEMENT..... | 47 – 48 | | |
| 17 | SPECIFICATIONS..... | 49 | | |
| 18 | OPTIONS | 50 | | |

1

PANEL DESCRIPTION

Switches, controls, keys and connectors

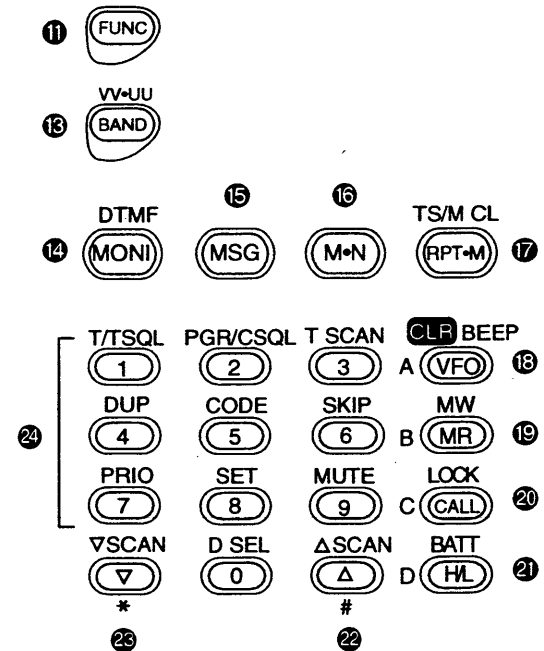
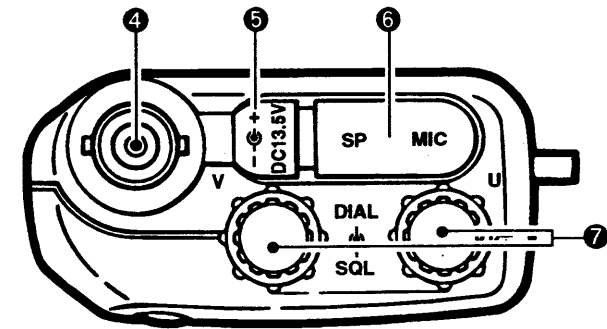
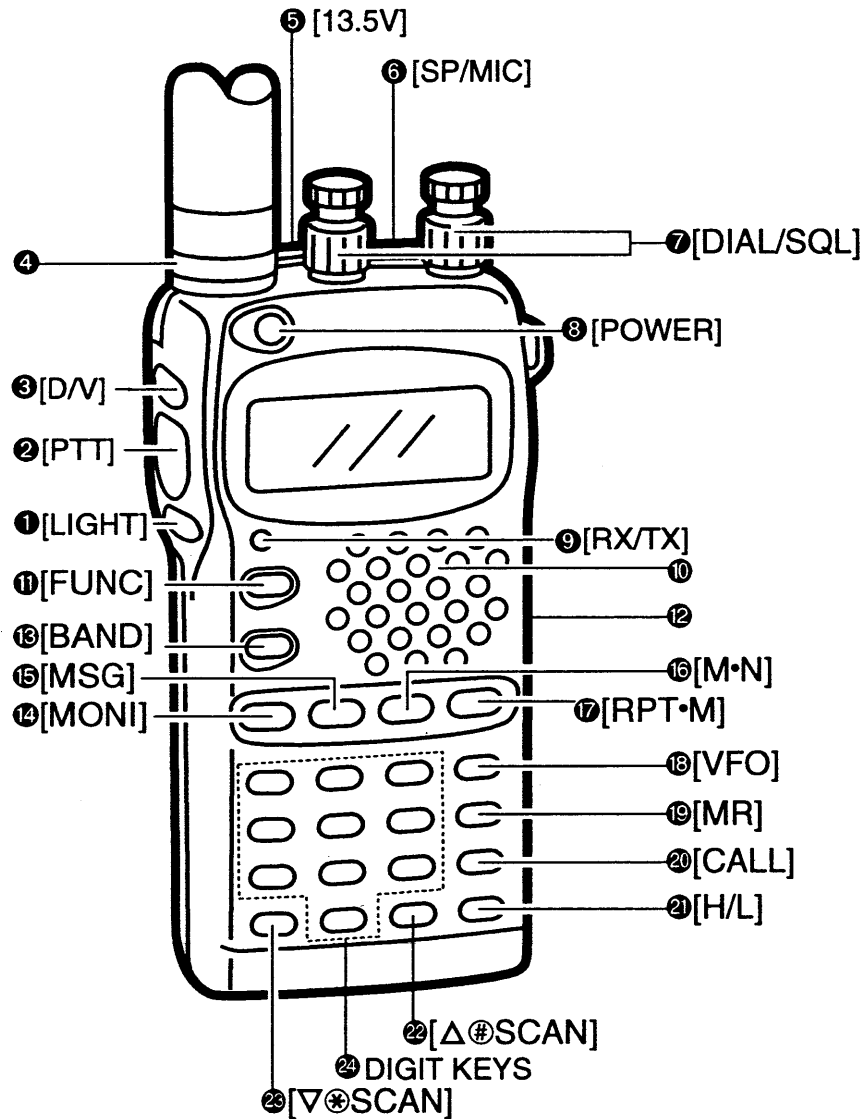

① LIGHT SWITCH [LIGHT]

- ➔ Push to activate display and keypad backlighting for 5 sec.
- ➔ Push [FUNC] then [LIGHT] to manually turn the backlighting ON/OFF.

② PTT SWITCH [PTT] (p. 17)

- ➔ Push and hold to transmit; release to receive.

③ DIAL/VOLUME SWITCH [D/V] (p. 17)

- ➔ Sets the [DIAL] function as a tuning control while pushing this switch.
 - The priority of the [DIAL] function can be selected in set mode (p. 42).

④ ANTENNA CONNECTOR (p. 12)

Connects the supplied antenna.

⑤ EXTERNAL DC POWER JACK [DC13.5V]

Allows operation with a 13.5 V DC power source using the optional cables, CP-12 or OPC-254.

CAUTION: Operation with an external DC power source simultaneously charges batteries inside the battery case or the battery pack. When using dry cell batteries this may cause battery leakage and damage the transceiver; when using a Ni-Cd battery pack this may cause battery overcharging and shorten the life of the battery pack.

⑥ EXTERNAL SPEAKER AND MICROPHONE JACKS [SP/MIC]

Connect an optional speaker-microphone or headset, if desired. The internal microphone will not function when either is connected. (See p. 50 for a list of available options.)

◇ External connection

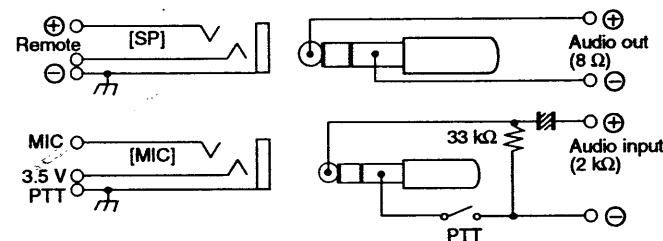

The above connection does not apply when a condenser microphone is connected.

⑦ TUNING/VOLUME DIALS [DIAL] AND SQUELCH CONTROLS [SQL]

- ➔ Rotate [DIAL] to adjust the audio level (default setting).
- ➔ Rotate [DIAL] while pushing [D/V] to select an operating frequency or memory channel.
- ➔ Rotate [SQL] clockwise to close and counterclockwise to open the squelch.

1 PANEL DESCRIPTION

⑧ POWER SWITCH [POWER] (p. ii)

Push and hold for 2 sec. to toggle the transceiver power ON and OFF.

⑨ RX/TX INDICATOR [RX/TX] (p. 17)

Lights green while receiving a signal or when the squelch is open; lights red while transmitting.

⑩ SPEAKER/MICROPHONE

⑪ FUNCTION KEY [FUNC]



Push to call up the function indicator, "F", then push another key to access its secondary function.

- "F" appears for 5 sec. after [FUNC] is pushed; at this time pushing [FUNC] again cancels the indication.
- This key cannot be activated during transmit.

NOTE: In general, "F" disappears when another key is pushed to activate a secondary function. However, some keys which have more than one secondary function, (such as [④DUP]), do not cancel "F." In this case, "F" disappears automatically after 5 sec.

⑫ BATTERY PACK RELEASE (p. 11)

Push to open the latch for battery pack removal.

⑬ BAND KEY [BAND(VV•UU)]



- ➔ Push to toggle the main band (p. 13).
- ➔ Push [FUNC] then push this key momentarily to activate the U by U and V by V functions (p. 19).

- ➔ Push [FUNC] then push and hold this key to toggle the single band function ON and OFF (p. 19).

⑭ MONITOR KEY [MONI(DTMF)]



- ➔ Push this key to open the main band's squelch without changing the [SQL] setting. (p. 17).
- ➔ During transmit, push this key to transmit a selected DTMF code (p. 27).
- ➔ Push [FUNC] then this key to enter DTMF memory mode (p. 27).

⑮ MESSAGE KEY [MSG]



- ➔ Push this key once to indicate receive message memories; twice to indicate transmit message memories.
 - Rotate [DIAL] to select the desired message memory.
- ➔ Push [FUNC] then this key to enter message receive mode (p. 38).
 - "MSG" appears.
 - Pager or code squelch must be activated to receive a message.
- ➔ During transmit, push this key then a message memory number to transmit the corresponding message (p. 38).

⑯ MEMORY NAME KEY [M•N]



- ➔ In memory mode, push to toggle between frequency and channel indication.(p. 25)
- ➔ Push [FUNC] then push this key to enter mem-

ory name writing mode from memory mode (p. 25).

17 REPEATER MEMORY KEY [RPT•M(TS/M CL)]

- TS/M CL ➔ Push this key to call up a repeater memory (p. 22).
-  • Push [VFO] or [MR] to return to previous indication.
- ➔ In VFO mode, push [FUNC] then this key to select a tuning step (p. 16).
- ➔ In memory mode, push [FUNC] then push and hold this key to clear the indicated memory (p. 25).
- ➔ While pushing [PTT], push this key for 1 to 2 sec. to transmit a 1750 Hz tone burst for repeater access (Eur., U.K., and Italy versions only; p. 20).

18 VFO MODE KEY [VFO(CLR)(BEEP)]

- CLR BEEP ➔ Push this key to cancel most functions, then push again to select VFO mode.
- A  • When making a mistake during input, push this key to cancel and start from the beginning.
- ➔ Push [FUNC] then this key to toggle beep tones ON and OFF (p. 19).
- ➔ While pushing [PTT], this key sends a DTMF "A."

19 MEMORY MODE KEY [MR(MW)]

- MW ➔ Push this key to select memory mode (p. 13).
- B  ➔ Push [FUNC] then this key to write (frequency, etc.) to another mode such as VFO to memory, VFO to scan edge memory, memory to memory,

etc. (p. 23).

- Writing operation is: [FUNC], [MR(MW)], [DIAL] then push and hold [MR(MW)].

➔ While pushing [PTT], this key sends a DTMF "B."

20 CALL MODE KEY [CALL(LOCK)]

- LOCK ➔ Push this key to select the call channel (p. 13).
- C  ➔ Push [FUNC] then this key to toggle the lock function ON and OFF (p. 13).
- "L" appears while the lock function is activated.
 - [POWER], [VOL], [MONI], [LIGHT], [SQL], and [FUNC] can still be accessed while the lock function is on.

21 OUTPUT POWER KEY [H/L(BATT)]

- BATT ➔ Push this key to select one of 3 output power levels: high, low or economical low (p. 17).
- D  ➔ Push [FUNC] then this key to indicate the remaining battery voltage for the connected battery pack (p. 41).
- ➔ While pushing [PTT], this key sends a DTMF "D."

22 UP KEY [Δ(Δ SCAN)]

- ΔSCAN ➔ In VFO mode, push this key to increment the frequency according to the selected tuning steps, in memory mode, push this key to increment the memory channel (p. 15).
-  ➔ Push this key for 0.5 sec. to start full or memory scan in the "up" direction (p. 30).
- # ➔ Push [FUNC] then this key to start programmed

1 PANEL DESCRIPTION

- or memory skip scan in the “up” direction (p. 30).
- ➔ While pushing [PTT], this key sends a DTMF “F.”

23 DOWN KEY [▽(▽ SCAN)]



- ➔ In VFO mode, push this key to decrement the frequency according to the selected tuning steps, in memory mode, push this key to decrement the memory channel (p. 15).
- ➔ Push this key for 0.5 sec. to start full or memory scan in the “down” direction (p. 30).
- ➔ Push [FUNC] then this key to start programmed or memory skip scan in the “down” direction (p. 30).
- ➔ While pushing [PTT], this key sends a DTMF “E.”

24 DIGIT KEYS

- ➔ Input the specified digit during frequency input, memory channel selection, etc.
- ➔ Transmit the DTMF code of the specified digit while pushing [PTT].
- ➔ In addition, each key has one or more secondary functions after pushing [FUNC] as follows:



- ➔ Push [FUNC] then this key to toggle the dial select step between the 1 MHz and 100 kHz digits.
 - While “**D**” appears rotate [DIAL] to change the frequency according to the dial select step set above (even when “tuning dial” has priority over “volume”).



- ➔ Push [FUNC] then this key to activate the sub-audible tone encoder.
- ➔ When installing an optional UT-94 TONE SQUELCH UNIT, push [FUNC] then this key to activate the subaudible tone encoder, pocket beep, tone squelch, or normal operation, in that order (pgs. 39, 40).
 - “T” appears during tone operation; “T SQL ((•))” appears during pocket beep operation and “T SQL” appears during tone squelch operation.



- ➔ Push [FUNC] then this key to activate the pager or code squelch function or to turn them OFF (pgs. 35, 36).
 - “P” appears in place of the 100 MHz digit during pager operation; “C” appears in place of the 100 MHz digit during code squelch operation.







- ➔ During optional tone squelch operation, push [FUNC] then this key to start the tone scan (p. 40).



- ➔ Push [FUNC] then this key to select semi-duplex or simplex operation (p. 20).
 - “- DUP” appears during minus duplex operation, “DUP” appears during plus duplex operation and no indicator appears during simplex operation.



- ➔ Push [FUNC] then this key to enter code setting mode for pager or code squelch use. (p. 33).

- SKIP**

 ➔ In memory mode, push [FUNC] then this key to toggle the channel's skip setting ON/OFF (p. 31).
 • During pager or code squelch operation, the skip setting is used to set a code for "receive inhibit" (p. 33).
- PRIO**

 ➔ Push [FUNC] then this key to start priority watch (p. 32).
 • While in VFO mode priority watch becomes memory channel watch; when the call channel is indicated, priority watch becomes call channel watch.
- SET**

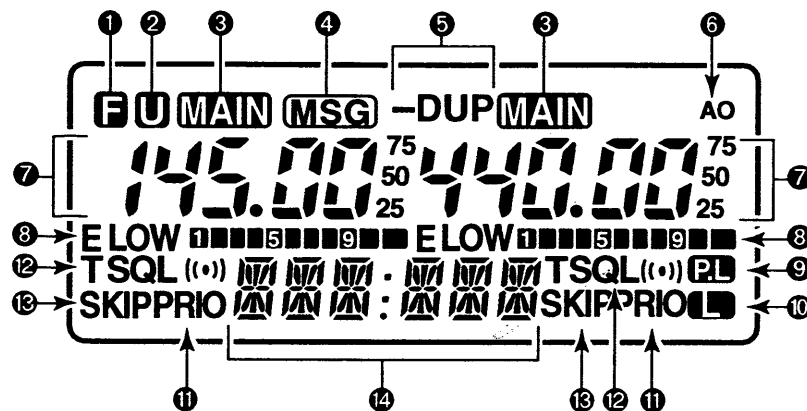
 ➔ Push [FUNC] then this key to enter set mode.
 • [Δ]/[▽] select set mode items and [DIAL] selects a set mode condition while in set mode.
- MUTE**

 ➔ Push [FUNC] then this key to activate the audio mute function (p. 17).
 • Push any key or switch to cancel the function.

1 PANEL DESCRIPTION

■ Function display



❶ FUNCTION INDICATOR

Shows that the secondary functions of switches can be accessed.

- This indicator appears for 5 sec. after [FUNC] is pushed.
- While this indicator appears, pushing [FUNC] cancels it.

❷ U BY U INDICATOR (p. 19)

Appears when the U by U or V by V function (two frequencies in one band) is in use.

- U by U is for the UHF band; V by V is for the VHF band.

❸ MAIN BAND INDICATORS (p. 13)

Appears above the frequency which is selected as the main band.

- Only one of these indicators appears at one time.

❹ MESSAGE INDICATOR (p. 38)

Appears when the message function is activated.

❺ DUPLEX INDICATOR (p. 20)

Appear when semi-duplex operation (repeater operation) is in use.

- “- DUP” appears when minus duplex is selected; “DUP” only, appears when plus duplex is selected.
- The indicator shows the main band condition only.

❻ AUTO POWER-OFF INDICATOR (p. 42)

Appears when the auto power-off function is in use.

❼ FREQUENCY READOUTS

Show the operating frequency, set mode contents, etc.

- The frequency on the left is for the VHF band; the frequency on

the right is for the UHF band, except during V/V or U/U operation.

- The smaller “75,” “50” and “25” to the right of each readout indicate kHz steps.
- The decimal point of the frequency flashes during scan. (p. 30)
- “P” or “C” appears in place of the 100 MHz digit while pager or code squelch is in use, respectively. (pgs. 33 – 36)

⑧ S/RF INDICATORS

- ➔ Show the relative signal strength while receiving. (p. 17)
- ➔ Show the output power selection while transmitting. (p. 17)
- ➔ “LOW” appears when low output power is selected.
- ➔ “E LOW” appears when economical low power is selected.
- ➔ No indicator appears when high output power is selected.

⑨ PTT LOCK INDICATOR (p. 43)

Appears when the PTT switch is electronically locked.

⑩ LOCK INDICATOR (p. 13)

Indicates that the lock function is in use.

⑪ PRIORITY INDICATOR (p. 32)

Appears when the priority watch is activated; flashes when the watch is paused.

⑫ TONE INDICATOR

- ➔ “T” appears when the subaudible tone encoder is in use.
- ➔ Additionally, “T SQL” and “T SQL ((·))” appear in sequence when the optional UT-94 TONE SQUELCH UNIT is activated. (p. 39)

⑬ SKIP INDICATOR (pgs. 31, 33)

Appears when a selected memory channel is set as a skip channel or when a code channel is set for “receive inhibit” during pager or code squelch operation.

- SKIP channels are used to speed up the scan interval by skipping frequencies which are often occupied such as repeaters, etc.

⑭ ALPHANUMERIC READOUTS

Show the selected memory channel number in memory mode.

- Memory names can be selected instead of channel numbers. (p. 25)
- Messages appear here when receiving a message while the message function is in use. (p. 37)
- Various other indications appear here in set mode, at power ON, etc., depending on programming.
- Volume level appears while rotating [DIAL].

■ Battery pack charging

The supplied* BP-171 or BP-180 BATTERY PACK includes rechargeable Ni-Cd batteries and can be charged approx. 300 times. Charge the battery pack before first operating the transceiver or when the battery pack becomes exhausted.

*Optional for versions which come with the BP-170 BATTERY CASE.

If you want to be able to charge the battery pack more than 300 times, the following points should be observed:

1. Avoid overcharging. The charging period should be less than 48 hours.
2. Use the battery until it becomes almost completely exhausted under normal conditions. We recommend battery charging just after transmitting becomes impossible.

■ Charging precautions

NEVER attempt to charge dry cell batteries. This will cause internal liquid leakage and damage the battery case and transceiver.

NEVER connect two or more chargers at the same time.

Charging may not occur under temperatures of 10°C (50°F) or over temperatures of 40°C (104°F).

■ About the battery pack

◇ Operating period

Depending on the attached battery pack, the operating period of the transceiver varies. Refer to the table below.

| BATTERY PACK | OUTPUT VOLTAGE | BATTERY CAPACITY | OUTPUT POWER (UHF, HIGH) | OPER. PERIOD (Approx.) | |
|--------------|----------------|------------------|--------------------------|------------------------|----------|
| | | | | VHF | UHF |
| BP-171 | 4.8 V | 700 mAh | 1.5 W | 5 h 50 m | 4 h 20 m |
| BP-172 | 4.8 V | 950 mAh | 1.5 W | 7 h 50 m | 6 h 00 m |
| BP-173 | 9.6 V | 650 mAh | 5 W | 3 h 20 m | 2 h 50 m |
| BP-180 | 7.2 V | 600 mAh | 3.5 W | 3 h 20 m | 2 h 50 m |

Condition: Tx (high) : Rx : Standby (power saved) = 1 : 1 : 8 (min.)
Operating periods are estimated values and vary depending on output power, temperature, etc.

◇ Battery pack life

When the operating period becomes extremely short even after charging the battery pack fully, a new battery pack is needed.

◇ Recycling information (U.S.A. only)

The product that you purchased contains a rechargeable battery. The battery is recyclable. At the end of its useful life, under various state and local laws, it may be illegal to dispose of this battery into the municipal waste stream. Check with your dealer or local solid waste officials for details in your area for recycling options or proper disposal.

■ Charging connections

◇ Regular charging

Attach the supplied* or optional battery pack; then, connect the supplied* wall charger via an AC outlet as shown below.

*Optional for versions which include a battery case.

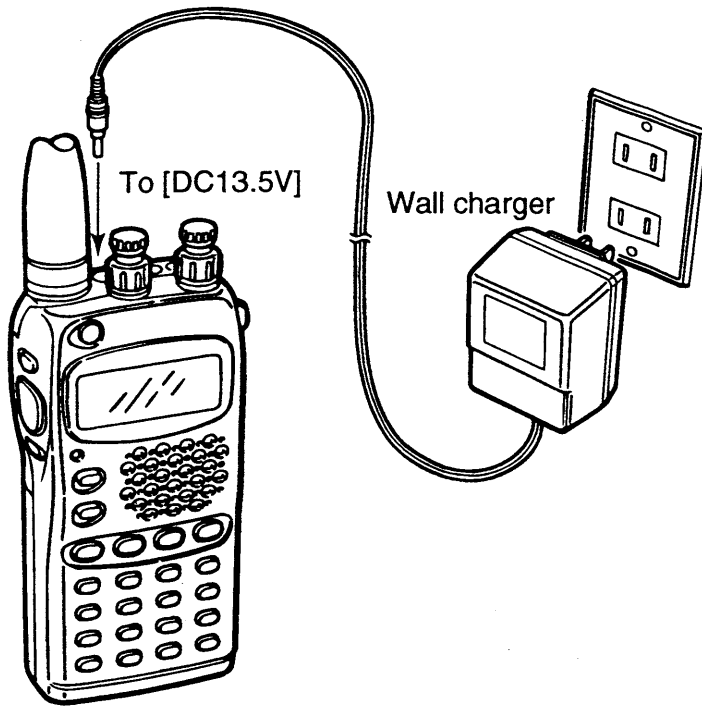

Charging periods:

15 hours (w/BP-171, BP-173 or BP-180)

20 hours (w/BP-172)

◇ Rapid charging with the BC-79

① Insert the AD-51A into the charging slot of the BC-79.

② Insert the AD-51B into the groove in the AD-51A (front-facing side of the AD-51A).

③ Insert the battery pack, either by itself or attached to the transceiver, into the AD-51B.

Any battery pack attached to transceiver

BP-173 or BP-180

BP-171 or BP-172 without transceiver

Check orientation for correct charging

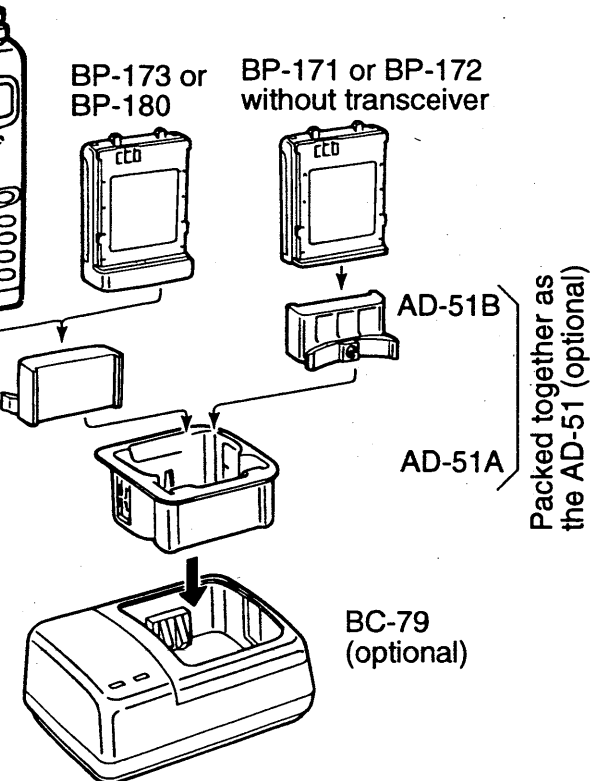

Charging periods:

1 hour (w/BP-171 or BP-180)

1.5 hours (w/BP-172 or BP-173)

2 BATTERY PACKS AND ACCESSORIES

◇ Operation with an optional cable

Connect an optional charger or cable to the transceiver as illustrated below. Be careful of battery overcharging as the connected battery is charged simultaneously.

CAUTION: Remove dry cell batteries from the BP-170 BATTERY CASE when it is not in use.

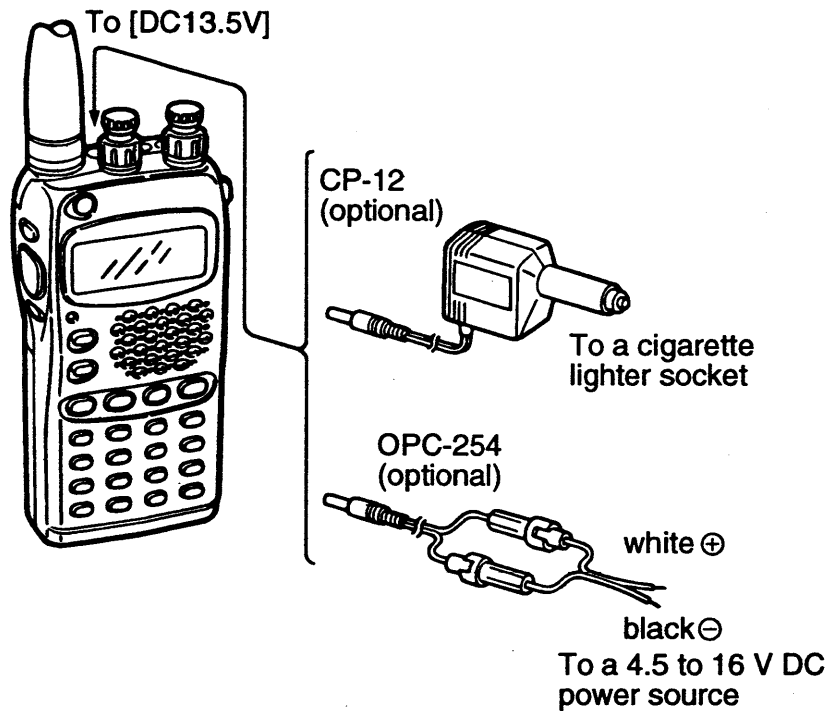

■ Battery case

When using a battery case attached to the transceiver, install 4 AA(R6) size alkaline batteries as illustrated below.

Remove the case from the transceiver.

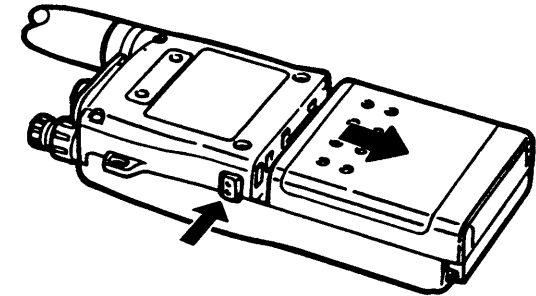

Open the case.

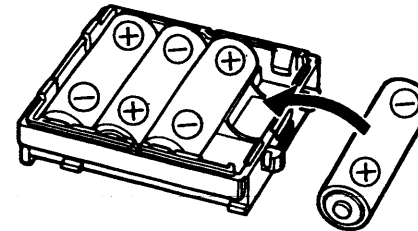
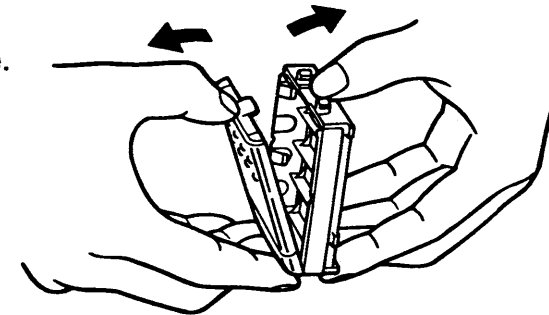

Install 4 AA(R6) size dry cell batteries into the battery case.

■ Accessory attachment

◇ Antenna

Insert the supplied antenna into the antenna connector and rotate the antenna as shown in the diagram below.

Keep the jack cover attached when jacks are not in use to avoid bad contacts.

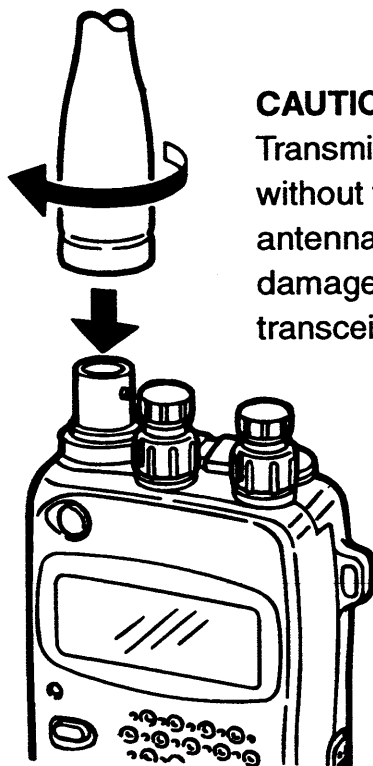

CAUTION:
Transmitting without the antenna may damage the transceiver.

◇ Belt clip

Remove the plastic screws, then attach the belt clip with the supplied metal screws. Conveniently attaches to your belt.

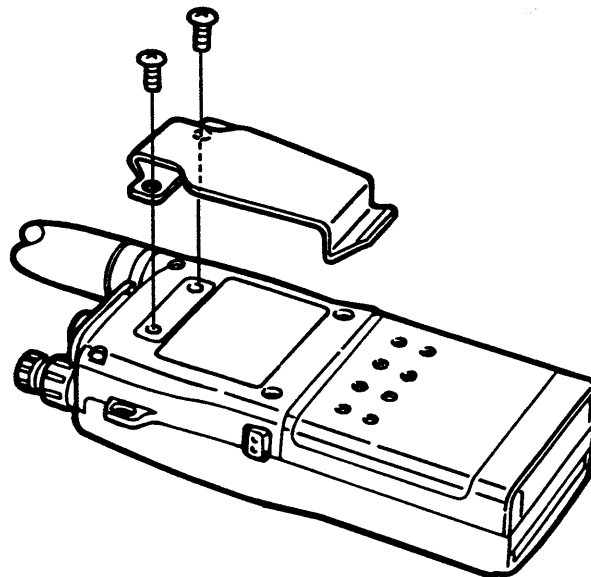

◇ Handstrap

Attach the handstrap as shown in the diagram below. Facilitates carrying.

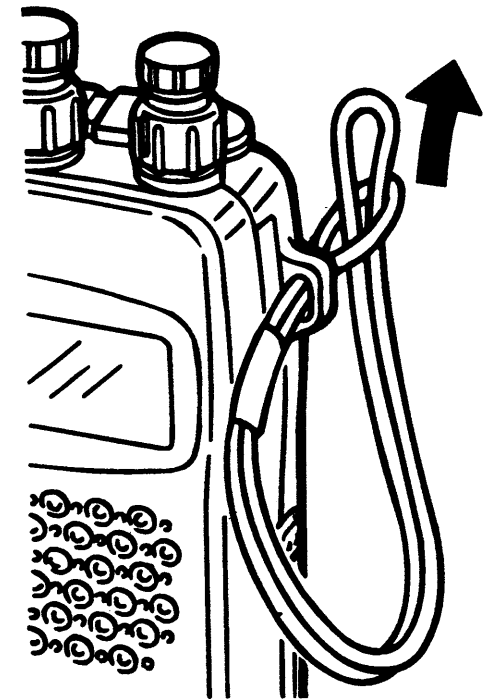

VFO and memory/call channels

This transceiver has 2 normal operating modes: VFO mode and memory mode.

VFO mode is used for setting a desired frequency within the band range.

➔ Push [VFO] to select VFO mode.

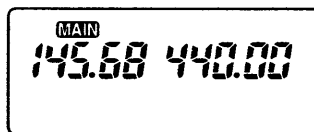

Memory (call) mode is used for operation of memory (call) channels which have programmed frequencies.

➔ Push [MR] to select memory mode.

- To program a memory, refer to p. 23.

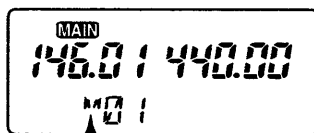

↑
“M” (or a memory name) appears

➔ Push [CALL] to select a call channel.

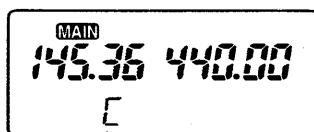

↑
“C” or “CALL” appears

What is VFO?

VFO is an abbreviation of Variable Frequency Oscillator. Frequencies for transmitting and receiving are generated and controlled by the VFO.

Band selection

This transceiver can receive VHF and UHF band signals simultaneously. To change frequency or to activate a function, you must designate a band, VHF or UHF, as the main band. All switches affect the designated main band only.

- “**MAIN**” appears above the main band.

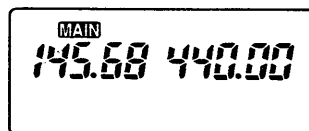

VHF is selected as the main band.

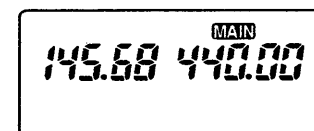

UHF is selected as the main band.

Lock function

The lock function prevents accidental frequency changes and accidental function access.

➔ Push [FUNC] then [(CALL)LOCK] to toggle the lock function ON and OFF.

- “**L**” appears when the lock function is activated.
- [VOL], [SQL], [MONI], [PTT], [POWER] and [LIGHT] function normally even when the lock function is activated.

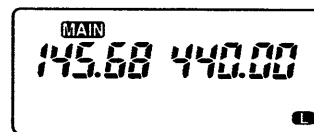

Lock function is activated.

■ Frequency or channel selection via the keypad

◇ Frequency

- ① Select VHF or UHF with [BAND].
- ② Select VFO with [VFO].
- ③ Push 4 digit keys, starting from the 1 MHz digit, to input a frequency.
 - When a digit is mistakenly input, push [(VFO)CLR] and input from the beginning.
 - “0,” “2,” “5” and “7” are acceptable for the 1 kHz digits (depending on the 10 kHz digit).

◇ Memory channels

- ① Select VHF or UHF with [BAND].
- ② Select memory mode with [MR].
- ③ Push 2 digit keys to select the desired memory channel.
 - The first nine memory channels are preceded by a “0.”
 - Scan edge channels, 1A to 3B, cannot be selected in this way.
 - Only programmed memory channels can be selected.

[EXAMPLE]: Setting the frequency to 145.360 MHz.

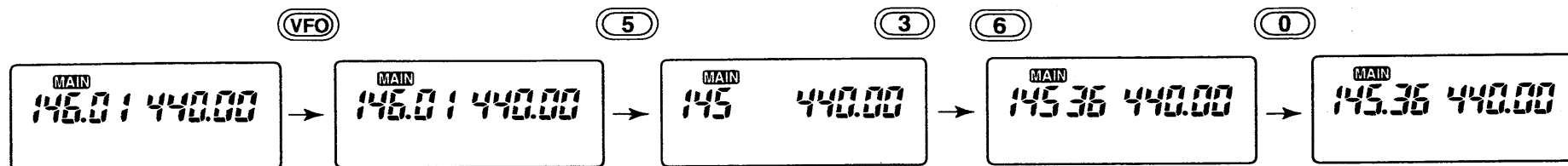

[EXAMPLE]: Selecting memory channel 43 (when channel 43 is already programmed).

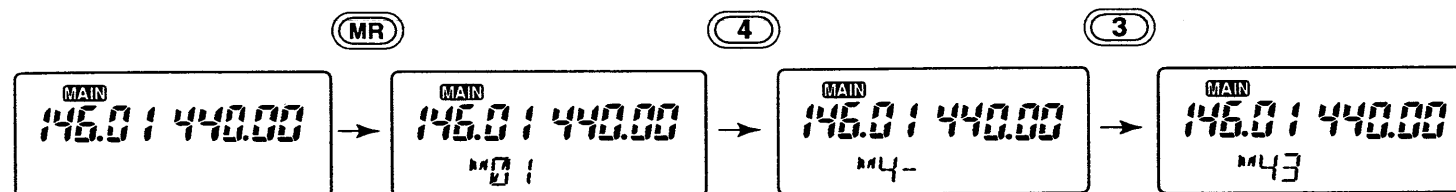

3 FREQUENCY AND CHANNEL SETTING

■ Using the tuning dial

◇ Frequency

- ① Select VHF or UHF with [BAND].
- ② Select VFO with [VFO].
- ③ While pushing [D/V], rotate [DIAL] to change the frequency.
 - The frequency changes according to the preset tuning steps. See the following page for setting tuning steps.
 - Push [FUNC] then rotate [DIAL] (without pushing [D/V]) to change the frequency in 100 kHz or 1 MHz steps.

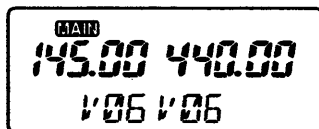

[DIAL] adjusts volume (default setting).
• "V" appears.

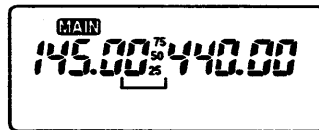

[D/V] + [DIAL] changes the frequency according to the selected tuning step.

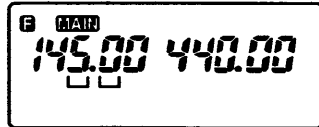

While "M" appears, [DIAL] changes the frequency in units of 1 MHz or 100 kHz.

◇ Memory channels

- ① Select VHF or UHF with [BAND].
- ② Select memory mode with [MR].
- ③ While pushing [D/V], rotate [DIAL] to change the indicated memory channel.
 - Only programmed memory channels can be selected.
 - While "M" appears, scan edges, 1A to 3B, can be selected.

■ Using the Δ/∇ keys

In VFO mode: Each push of the Δ/∇ keys changes the frequency according to the selected tuning.

- The dial select function cannot be used.

In memory mode: Each push of the Δ/∇ keys increments or decrements the indicated memory channel, respectively.

- Only programmed memory channels can be selected.
- Scan edge channels, 1A to 3B, cannot be selected.

 Be careful not to push the Δ/∇ keys for more than 0.5 sec., otherwise a scan will be activated. If a scan is accidentally activated, push [Δ] or [∇] momentarily to stop it.

■ Setting tuning dial increments

◇ Tuning step selection

Tuning steps can be selected for each band. This transceiver has 8 tuning steps as follows:

- 5 kHz • 10 kHz • 12.5 kHz • 15 kHz
- 20 kHz • 25 kHz • 30 kHz • 50 kHz

- ① Select VHF or UHF with [BAND].
- ② Select VFO mode with [VFO].
- ③ Push [FUNC] then [(RPT•M)TS] to enter the tuning step setting condition.
 - Previously selected tuning step appears.
- ④ Rotate [DIAL] (without pushing [D/V]) to select the desired tuning step.
- ⑤ Push [(VFO)CLR] to set the selected tuning step.

NOTE: For convenience, select a tuning step that matches the frequency intervals of repeaters in your area.

[DISPLAY EXAMPLE]

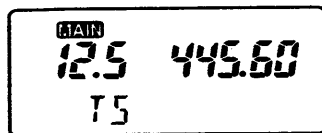

12.5 kHz tuning step (VHF)

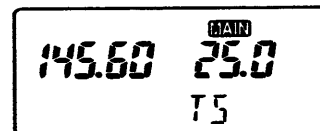

25 kHz tuning step (UHF)

◇ Setting a dial select step

In VFO mode, rotating [DIAL] (without pushing [D/V]) while “” appears (after [FUNC] is pushed) changes the frequency in 100 kHz or 1 MHz steps.

This function is useful for quick tuning and can be set individually for each band.

- ① Select VHF or UHF with [BAND].
- ② Select VFO mode with [VFO].
- ③ Push [FUNC] then [ⓈD SEL] once or twice to set the dial select step.
 - The selected digit, (100 kHz or 1 MHz) flashes.
- ④ Push [FUNC] then rotate [DIAL] (without pushing [D/V]) to change the frequency using the dial select step.

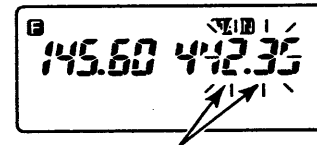

Selected digit, 1 MHz or 100 kHz, flashes while setting the dial select step.

Receive and transmit

CAUTION: Transmitting without an antenna may damage the transceiver.

- ① Push [POWER] for 2 sec. to turn power ON:
- ② Set the squelch and audio levels (see right).
- ③ Set an operating frequency.
When a signal is received:
 - The TX/RX indicator lights green.
 - Squelch opens and audio is emitted from the speaker.
 - The receiving band's S/RF indicator shows the relative signal strength.
- ④ Push and hold [PTT] to transmit; then speak into the mic.
 - Do not hold the microphone too close to your mouth or speak too loudly. This may distort the signal.
 - The TX/RX indicator lights red.
 - The S/RF indicator shows the output power selection.
 - The sub band can receive while transmitting on the main band, depending on the set mode setting.
- ⑤ Release [PTT] to return to receive.

CONVENIENT

Monitor function: Push and hold [MONI] to listen to weak signals without disturbing the squelch settings.

Audio mute function: Push [FUNC] then [MUTE] to mute the audio without disturbing the volume settings.

- "AFMUTE" appears in the display.
- Push any key to cancel the mute function.

Setting volume

Audio output for the transceiver is adjusted using the [DIAL] control and is independently adjustable for each band. When the priority action of the [DIAL] is set to "tuning dial," rotate [DIAL] while pushing [D/V] to adjust audio (p. 42).

- ① Rotate [SQL] maximum counter-clockwise.
- ② Rotate [DIAL] (or rotate [DIAL] while pushing [D/V]) to adjust the audio.
 - "V00" to "V16" appears while [DIAL] is rotated.
- ③ Rotate [SQL] clockwise until noise is just muted.
 - Each band's audio must be adjusted separately.

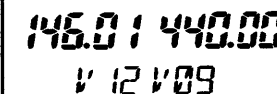

145.01440.00
V 12 V09

Output power selection

Push [H/L] one or more times to select the desired output power.

- High, low and economical low power are selectable.
- Output power can be selected individually for each band.

| POWER SELECTION | S/RF INDICATOR | OUTPUT POWER (typical; at 13.5 V) | |
|-----------------|----------------|-----------------------------------|-------|
| | | VHF | UHF |
| HIGH | ■■■■■□■■■■■ | 5.0 W | 5.0 W |
| LOW | LOW ■■■■ | 0.5 W | 0.5 W |
| E LOW | E LOW ■ | 15 mW | 15 mW |

◇ **Automatic power down function**

The automatic power down function automatically selects “E LOW” (15 mW) as the output power just before the battery becomes exhausted. When this function activates, the battery will be immediately exhausted.

- When using dry cell batteries with the BP-170, you can still transmit for a short time at “E LOW.”
- This function can be turned OFF and ON as illustrated below.

USING SET MODE

SETTING THE AUTOMATIC POWER DOWN FUNCTION ON/OFF

The automatic power down function is ON.

The automatic power down function is OFF.

- ① Push [FUNC] then [ⓈSET] to enter set mode.
- ② Push [▽] or [△] until “E LOW” appears as shown above.
- ③ Rotate [DIAL] to turn the automatic power down function ON or OFF.
- ④ Push [(VFO)CLR] to set the condition and to exit set mode.

◇ **Crossband full duplex operation**

The crossband full duplex function can be turned ON or OFF in set mode. When the function is OFF, the sub band audio is muted during transmission.

USING SET MODE

SELECTING CROSSBAND FULL DUPLEX OR SEMI-DUPLEX

Crossband full duplex is ON.

Crossband full duplex is OFF.

- ① Push [FUNC] then [ⓈSET] to enter set mode.
- ② Push [▽] or [△] until “F DUP” appears as shown above.
- ③ Rotate [DIAL] to select crossband full duplex (“on”) or semi-duplex (“OFF”).
- ④ Push [(VFO)CLR] to set the condition and to exit set mode.

4 BASIC OPERATION

■ U by U and V by V functions

The transceiver can receive 2 frequencies simultaneously on either the VHF or UHF band using the U by U function.

① Turn the single band function OFF if it is in use (opposite).

② Push [FUNC] then [(BAND)VV•UU] to turn the U by U function ON or twice to turn the V by V function ON.

- “U” appears in the VHF display.
- Both band frequency displays show UHF frequencies or VHF frequencies while the function is in use.

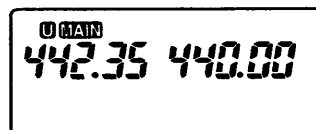
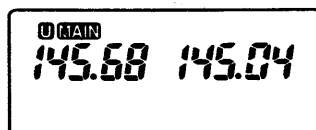

③ Push [FUNC] then [(BAND)VV•UU] once or twice to cancel.

NOTE:

- Memory channels and repeater memory are used for both frequency displays.
- The left frequency display cannot use 5 and 15 kHz tuning steps while in the U by U function.
- Repeater memories cannot be overwritten while they are indicated in the sub band frequency display.
- The receive frequency of the sub band display is muted during main band transmitting.

■ Single band function

This function turns the sub band circuit OFF and allows the transceiver to be used as a mono band transceiver. This function is useful to conserve battery power.

① Turn the U by U function OFF if it is in use (opposite).

② Push [FUNC] then push and hold [BAND] for 1 sec. to turn the sub band OFF.

- The sub band frequency, etc. disappears.
- The operating band can be changed with [BAND].

③ To turn the sub band ON again, repeat step ② above.

- The sub band frequency, etc., appears.

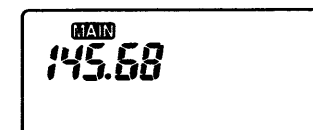

This display shows the UHF band's circuit is turned OFF.

■ Beep tones on/off

The confirmation beep tones, which sound each time a switch is pushed, can be turned ON or OFF, as desired.

➡ Push [FUNC] then [(VFO)BEEP] to toggle the beep tones ON and OFF.

■ General

When using a repeater, the transmit frequency is shifted from the receive frequency by the offset frequency (p. 21). It is convenient to program repeater information into memory channels (p. 23).

- ① Select VHF or UHF with [BAND].
- ② Set the receive frequency (repeater output frequency).
- ③ Push [FUNC] then [④DUP] to select – DUP or push [④DUP] again (while “**F**” appears) to select DUP.
 - “– DUP” or “DUP” appears to indicate the transmit frequency for minus shift or plus shift, respectively.
 - When the auto repeater function is in use (U.S.A. and Korea versions only) this selection and step ④ are not necessary (p. 22).
- ④ Push [FUNC] then [①T/TSQL] to activate the subaudible tone encoder, according to repeater requirements.
 - Refer to the following page for tone frequency settings.
- ⑤ Push and hold [PTT] to transmit.
 - The displayed frequency automatically changes to the transmit frequency (repeater input frequency).
 - The operating condition is automatically programmed into a repeater memory. See p. 22 for details.
 - If “oFF” appears, check the offset frequency (p. 21)
- ⑥ Release [PTT] to receive.
- ⑦ Push and hold [MONI] to check whether the other station’s transmit signal can be directly received or not.

Some repeaters require a tone to be accessed. In this case, precede step ⑤ at left with the required tone.

DTMF TONES

While pushing [PTT], push the desired digit key(s) to transmit DTMF tones.

- The transceiver has 6 DTMF memory channels. See p. 27 for details.

1750 Hz TONE (Eur., Italy and U.K. versions only)

While pushing [PTT], push and hold [RPT•M] for 1 to 2 sec. to transmit a 1750 Hz tone burst signal.

5 REPEATER OPERATION

■ Subaudible tones

Some repeaters require subaudible tones to be accessed. Subaudible tones are superimposed over your normal signal and must be set in advance.

USING SET MODE

SETTING SUBAUDIBLE TONES

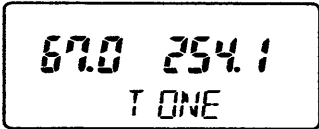

VHF tone: 67.0 Hz
UHF tone: 254.1 Hz



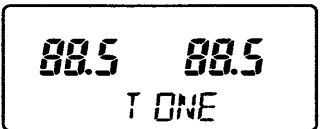

VHF tone: 88.5 Hz
UHF tone: 88.5 Hz

- ① Push [FUNC] then [ⓈSET] to enter set mode.
- ② Push [▽] or [△] until "TONE" appears as shown above.
- ③ Rotate [DIAL] to select the desired subaudible tone (separately selectable for each band).
- ④ Push [(VFO)CLR] to set the condition and to exit set mode.

• Subaudible tone frequency list

(Unit: Hz)

| | | | | | | | | | |
|------|------|-------|-------|-------|-------|-------|-------|-------|-------|
| 67.0 | 79.7 | 94.8 | 110.9 | 131.8 | 156.7 | 171.3 | 186.2 | 203.5 | 229.1 |
| 69.3 | 82.5 | 97.4 | 114.8 | 136.5 | 159.8 | 173.8 | 189.9 | 206.5 | 233.6 |
| 71.9 | 85.4 | 100.0 | 118.8 | 141.3 | 162.2 | 177.3 | 192.8 | 210.7 | 241.8 |
| 74.4 | 88.5 | 103.5 | 123.0 | 146.2 | 165.5 | 179.9 | 196.6 | 218.1 | 250.3 |
| 77.0 | 91.5 | 107.2 | 127.3 | 151.4 | 167.9 | 183.5 | 199.5 | 225.7 | 254.1 |

■ Offset frequency

When communicating through a repeater, the transmit frequency is shifted from the receive frequency by an amount determined by the offset frequency.

USING SET MODE

SETTING AN OFFSET FREQUENCY

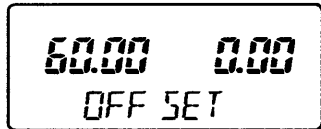

VHF offset: 60 MHz
UHF offset: none





VHF offset: none
UHF offset: 5 MHz

- ① Push [FUNC] then [ⓈSET] to enter set mode.
- ② Push [▽] or [△] until "OFF SET" appears as shown above.
- ③ Rotate [DIAL] to select the desired offset (separately selectable for each band).
- ④ Push [(VFO)CLR] to set the condition and to exit set mode.

■ Repeater memory

The transceiver has a repeater memory in each band to store repeater information separately from regular channels and the call channel.

When transmitting with duplex ON, the following information is automatically programmed into the repeater memory.

- Repeater output frequency (your receiving frequency).
- “- DUP” or “DUP” setting and offset frequency.
- “T” setting and subaudible tone frequency (when used).

After you operate the transceiver in simplex, you can easily call up the repeater memory.

- ① Push [RPT•M] to call up the repeater memory.
 - Programmed repeater information and “RP” appears.
 - Repeater memory is blanked after CPU resetting.
- ② To return to VFO mode or memory mode, push [VFO] or [MR], respectively.

[REPEATER MEMORY]

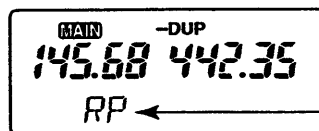

“RP” appears

■ Auto repeater function (U.S.A. version only)

The U.S.A. version automatically activates the repeater settings (duplex ON/OFF, duplex direction, tone encoder ON/OFF) when the main band operating frequency falls within or outside of the general repeater output frequency range, respectively. The offset frequency and subaudible tone frequency are not changed by the auto repeater function, reset these frequencies, if necessary.

USING SET MODE

SETTING THE AUTO REPEATER FUNCTION

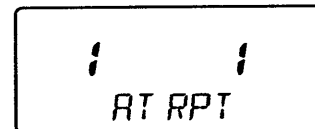

Activates for duplex only.



Activates for duplex and tone.

- ① Push [FUNC] then [ⓈSET] to enter set mode.
- ② Push [▽] or [△] until “AT RPT” appears as shown above.
- ③ Rotate [DIAL] to turn the auto repeater function ON or OFF.
- ④ Push [(vFO)CLR] to set the condition and to exit set mode.

■ General

The transceiver has 43 memory channels (plus 3 pairs of scan edge channels) and 1 call channel on each band for storage of often-used frequencies.

◇ Memory/call channel contents

The following information can be programmed into memory/call channels:

- Operating frequency
- Duplex direction (DUP or – DUP and its offset frequency (pgs. 20, 21))
- Subaudible tone encoder (or optional tone squelch) ON/OFF and its frequency (pgs. 39, 21)
- Skip information

■ Programming during selection

NOTE: Perform steps ④ and ⑤ below within 2 sec. otherwise programming will not be successful.

- ① Select VHF or UHF with [BAND].
- ② Select VFO mode with [VFO].
- ③ Set the desired frequency:
 - Set the frequency using the keypad or [DIAL].
 - Set other data (e.g. offset frequency, duplex direction, subaudible tone frequency, etc.), if required.
- ④ Push [FUNC] then [(MR)MW] momentarily to indicate memory channels.
 - Do not hold [MW] for more than 0.5 sec., otherwise the memory channel will overwrite the displayed number.
- ⑤ Rotate [DIAL] to select the desired channel.
 - Memories not yet programmed are preceded by "--" in front of the channel number.
 - Call channel and scan edge channels, as well as regular memory channels, can be programmed in this way.
- ⑥ Push [(MR)MW] for 1 sec. to program.

[EXAMPLE]: Memory programming to ch 40 during selection.

Set frequency and other data (FUNC) + (MR) (momentarily)

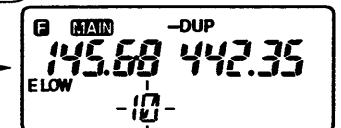
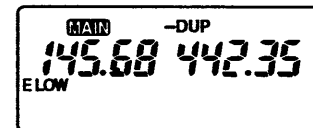

■ Programming after selection

- ① Select VHF or UHF with [BAND].
- ② Select the memory channel to be programmed.
 - ➔ Push [MR] to select memory mode.
 - ➔ Push [▽]/[△] or 2 digit keys to select the memory channel (only programmed memories can be selected).
- ③ Set the desired frequency in VFO mode:
 - ➔ Push [VFO] to select VFO mode.
 - ➔ Set the desired frequency using the keypad or [DIAL].
 - ➔ Set other data (e.g. offset frequency, duplex direction, subaudible tone frequency, etc.), if required.
- ④ Push [FUNC] then [(MR)MW] for 1 sec. to program.
 - If beep tones are turned ON, 3 beeps alert you that the VFO contents, including duplex information, subaudible tone frequency, etc., are programmed.

NOTE: Call channels cannot be programmed in this way.

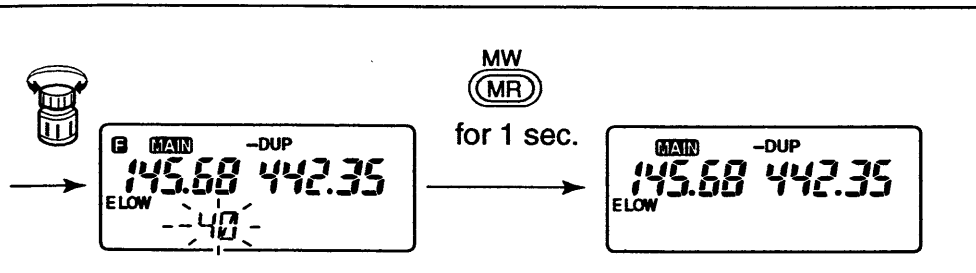

■ Memory edit (transferring)

Memory (call) channel contents can be moved to VFO or to another memory.

◇ Memory/call⇒VFO

- ① Select VHF or UHF with [BAND].
- ② Select the memory (call) channel to be transferred:
 - ➔ Push [MR] (or [CALL]) to select memory (call) mode.
 - ➔ Push [▽]/[△] or 2 digit keys to select the memory channel (only programmed memories can be selected).
- ③ Push [FUNC] then [(MR)MW] for 1 sec. to transfer.
 - “VFO” appears for a while and VFO mode is selected.

◇ Memory/call⇒memory

- ① Select VHF or UHF with [BAND].
- ② Select the memory (call) channel to be transferred:
 - ➔ Push [MR] (or [CALL]) to select memory (call) mode.
 - ➔ Push [▽]/[△] or 2 digit keys to select the memory channel (only programmed memories can be selected).
- ③ Push [FUNC] then [(MR)MW] momentarily.
 - “VFO” appears in the display.
- ④ Rotate [DIAL] to select a memory channel to transfer the data.
- ⑤ Push [(MR)MW] for 1 sec.
 - The contents are transferred and the original channel is selected.

6 MEMORY/CALL PROGRAMMING

■ Memory clear

Unwanted memory channels can be cleared (erased). Before clearing a memory channel make sure it is no longer needed as cleared memories cannot be recalled.

- ① Select memory mode with [MR].
- ② Select the memory channel to be cleared.
- ③ Push [FUNC] then push and hold [(RPT•M)M CL] for 1 sec.
 - “---.--” appears briefly in place of the frequency, the memory is cleared and the next programmed memory is automatically selected.

■ Memory names

Memory channels can be programmed with names of up to 6 characters in length.

//// Names cannot be programmed into the call channel.

◇ Frequency ↔ name

To toggle between frequency indication and memory name indication:

- Push [M•N] when memory mode is selected.
- “NONAME” appears when a memory channel has not been programmed with a name (see opposite).

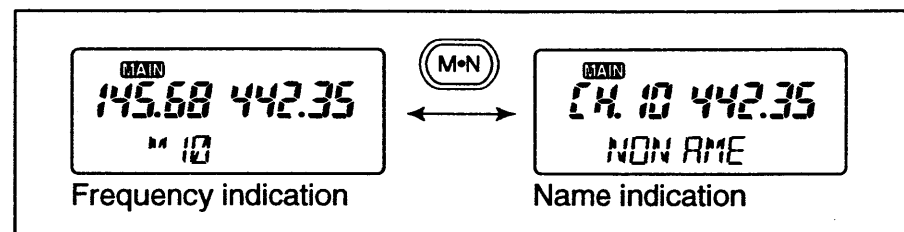

The following characters can be used in names:

- 0 to 9, A to Z (capitals), (space), (,), +, -, =, *, /, Δ, μ and Σ.

NOTE: While using the monitor function, the display shows the frequency even when memory name indication is selected.

◇ Programming memory names

- ① Select VHF or UHF with [BAND].
- ② Select the memory channel to be programmed:
 - ➔ Push [MR] to select memory mode.
 - ➔ Push [▽]/[△] or 2 digit keys to select the memory channel (only programmed memories can be selected).
- ③ Push [M•N] to select memory name indication.
- ④ Push [FUNC] then [M•N] to enter memory name writing mode.
 - The first character of the name flashes.
- ⑤ Rotate [DIAL] to select the first character.
- ⑥ Push [△] then rotate [DIAL] to select the next character.
 - Push [▽] to select the previous character.
- ⑦ Repeat step ⑥ until all desired characters have been input; then, push [M•N] to program.
 - Flashing stops.
 - Six characters is the maximum for a name.



WEATHER CHANNELS (U.S.A. version only)

10 weather channels are programmed separately from memory channels for easy recall.

- ① Select VHF band with [BAND].
- ② Push and hold [RPT•M] for 2 sec.
- ③ Push [▽]/[△] or [D/V] + [DIAL] to select the desired weather channel.
- ④ Push [VFO] to return to VFO mode.

■ Programming a DTMF code

The transceiver has 6 DTMF memory channels (d1 to d6) for storage of often-used DTMF codes of up to 30 digits. The memory channels are for common use on both bands.

- ① Push [FUNC] then [(MONI)DTMF] to enter DTMF memory mode.
- ② Rotate [DIAL] to select the desired channel.
- ③ Push [FUNC] then [8] to enter DTMF programming mode.
 - “--- ---” appears.
 - Programmed memories are cleared in this way.
- ④ Push digit keys to enter the desired DTMF code.
 - “*” appears after 30 digits have been input, indicating further input is not possible.
- ⑤ Push [(MONI)DTMF] to store them.
- ⑥ Push [PTT] to exit DTMF memory mode.
 - Pushing [(MONI)DTMF] exits while emitting the programmed code.

■ Transmitting a DTMF code

◇ Using a DTMF memory channel

- ① Push [FUNC] then [(MONI)DTMF] to enter DTMF memory mode.
- ② Rotate [DIAL] to select the desired channel.
- ③ Push [PTT] to exit DTMF memory mode.
- ④ While pushing [PTT], push [MONI] to transmit the selected DTMF code.

NOTE: Push [MONI] while in DTMF memory mode to monitor a DTMF channel without transmitting it.

[EXAMPLE]: Programming “21ABC3” into DTMF memory “d3”.

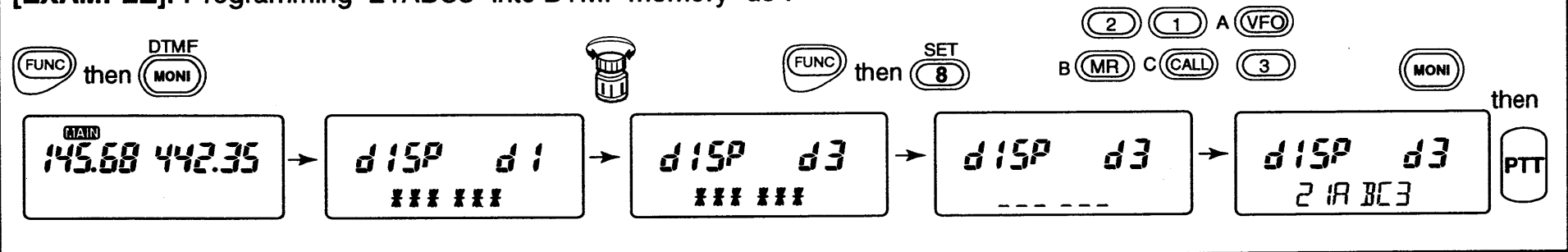

■ Confirming a DTMF channel's contents

Although 30 digits can be programmed into each DTMF memory channel, only 6 digits are visible at one time. The following procedure may be useful when you want to check the contents of a particular DTMF channel without transmitting it.

- ① Push [FUNC] then [(MONI)DTMF] to enter DTMF memory mode.
- ② Rotate [DIAL] to select the desired channel.
- ③ Push [FUNC] then rotate [DIAL] to scroll through the digits contained in the selected channel.
 - Clockwise rotation scrolls to the right and counterclockwise rotation scrolls to the left.
 - When "F" disappears from the display, the first 6 digits of the memory channel are displayed.
- ④ Push [PTT] to exit DTMF memory mode.

[EXAMPLE]: 75F2E134B6D programmed into d1.

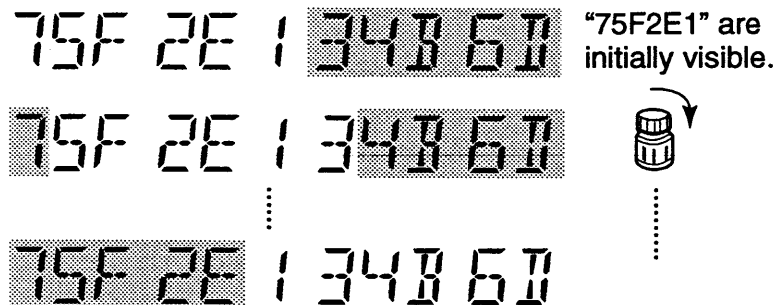

■ DTMF transmission speed

When slow DTMF transmission speeds are required (as for some repeaters), the transceiver's rate of DTMF transmission can be adjusted.

USING **SET MODE**

SETTING DTMF TRANSMISSION SPEED

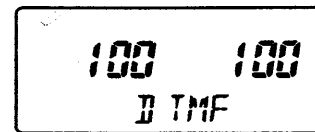

Fastest DTMF transmit speed.

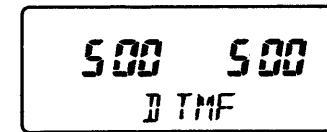

Slowest DTMF transmit speed.

- ① Push [FUNC] then [ⓈSET] to enter set mode.
- ② Push [▽] or [△] until "DTMF" appears as shown above.
- ③ Rotate [DIAL] to select the desired transmission speed.
 - 4 speeds are available: "100" being the fastest and "500" being the slowest.
- ④ Push [(VFO)CLR] to set the condition and to exit set mode.

■ Scan types

Each band has 4 scan types and 3 resume conditions providing scanning versatility. Scans on both bands can be operated separately or simultaneously.

FULL SCAN (p. 30)

Repeatedly scans all frequencies over the entire band.

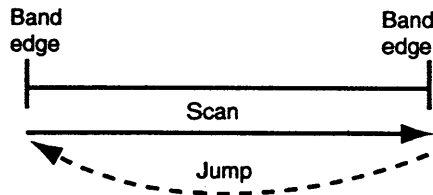

PROGRAMMED SCAN (p. 30)

Repeatedly scans between two user-programmed frequencies. Used for checking for frequencies within a specified range such as repeater output frequencies, etc.

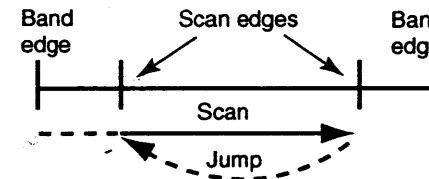

MEMORY SCAN (p. 30)

Repeatedly scans all memory channels in sequence.

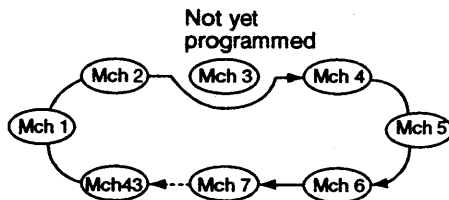

MEMORY SKIP SCAN (p. 30)

Repeatedly scans memory channels except skip channels. Used for checking often-called channels and bypassing usually busy channels such as repeater frequencies.

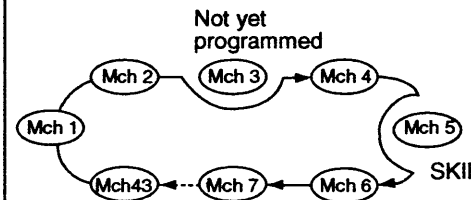

SCAN RESUME CONDITION (p. 31)

3 resume conditions are available: pause scan and 2 timer scans. When receiving a signal, pause scan pauses until the signal disappears; timer scans pause for 5 or 10 sec.

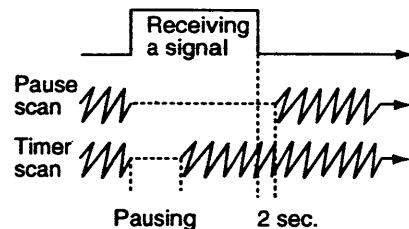

NOTE:

- Scans cannot be activated when:
 - priority watch is in use;
 - the pager or code squelch function is in use.
- If the optional pocket beep function is activated, the transceiver automatically selects the tone squelch function when a scan starts.

■ Full/programmed scan

- ① Select VHF or UHF with [BAND].
- ② Select VFO mode with [VFO].
- ③ Set the selected band's [SQL] to the point where noise is muted.

For full scan:

- ④ Push [▽/SCAN] or [△/SCAN] for 1 sec. to start full scan.

For programmed scan:

- ④ Push [FUNC] then [▽/SCAN] or [△/SCAN] to start the programmed scan.
 - "P1," "P2" or "P3" appears to indicate which pair of scan edges is being scanned.
- ⑤ Push [①], [②] or [③] to select the desired scan range or push [④] to select full scan.
- ⑥ To stop the scan, push [▽/SCAN] or [△/SCAN].

 For programmed scan, scan edges must be programmed in advance. Programming scan edges in the same manner as regular memory channels (p. 24).

 If the same frequencies are programmed into a pair of scan edges, programmed scan edge appears, such as "P1," but programmed scan does not proceed.

■ Memory (skip) scan

- ① Select VHF or UHF with [BAND].
- ② Push [MR] to select memory mode.
- ③ Set the selected band's [SQL] to the point where noise is muted.

For memory scan:

- ④ Push [▽/SCAN] or [△/SCAN] for 1 sec. to start the memory scan.

For memory skip scan:

- ④ Push [FUNC] then [▽/SCAN] or [△/SCAN] to start the memory skip scan.
- ⑤ To stop the scan, push [▽/SCAN] or [△/SCAN].

8 SCAN OPERATION

■ Skip channel setting

Memory channels can be set to be skipped for memory skip scan. This is useful to speedup the memory skip scan interval.

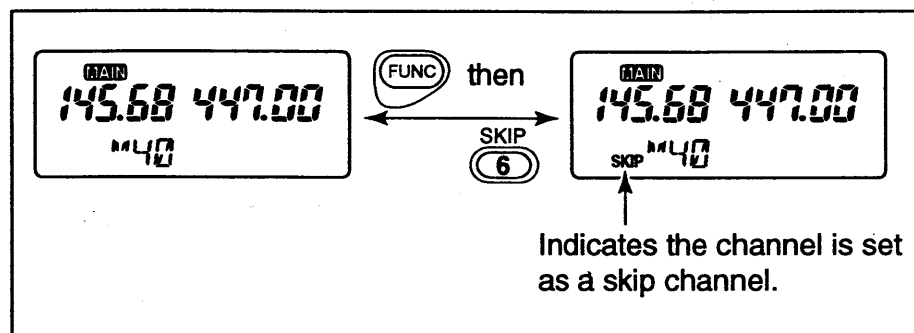

- ① Select the memory channel to be programmed as a skip channel:
 - ➔ Push [MR] to select memory mode.
 - ➔ Push [▽]/[Δ] or 2 digit keys to select the memory channel.
- ② Push [FUNC] then [ⓈSKIP] to set the memory channel as a skip channel.
 - “SKIP” appears.
- ③ Repeat step ② to cancel a skip channel.
 - “SKIP” disappears.

■ Scan resume condition

The resume condition can be selected as a pause or timer scan. The resume condition is used for scan and priority watch (p. 32).

USING SET MODE

SETTING THE SCAN RESUME CONDITION

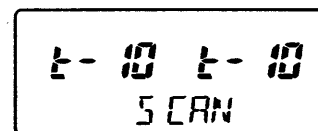

10 sec. timer resume condition.

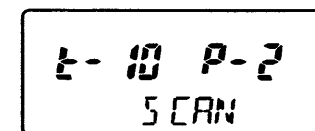

Pause timer resume condition for UHF band.

- ① Push [FUNC] then [ⓈSET] to enter set mode.
- ② Push [▽] or [Δ] until “SCAN” appears as shown above.
- ③ Rotate [DIAL] to select the desired resume condition.
 - “t-10”: scan pauses for 10 sec. on a received signal.
 - “t-5”: scan pauses for 5 sec. on a received signal.
 - “P-02”: scan pauses on a received signal until it disappears.
- ④ Push [(VFO)CLR] to set the condition and to exit set mode.

■ Priority watch types

The priority watch checks for signals on a memory or call channel every 5 sec. while operating on a VFO frequency. The transceiver has 2 priority watch types to suit your needs. You can transmit on the VFO frequency while the priority watch operates.

When receiving a signal, priority watch pauses according to the scan resume condition (see page at left).

Memory channel watch

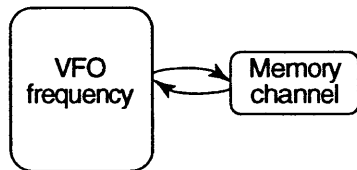

Call channel watch

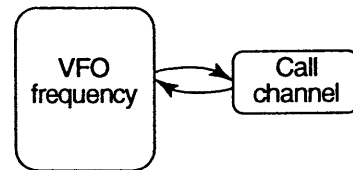

NOTE:

- Priority watch does not operate when the pager or code squelch function is activated (pgs. 35, 36).
- If the optional pocket beep function is activated, the transceiver automatically selects the tone squelch function when priority watch starts.

■ Priority watch operation

- ① Select VHF or UHF with [BAND].
- ② Select VFO; then, set a frequency.
- ③ Set the watching channel.
 - For memory channel watch:**
Select the desired memory channel.
 - For call channel watch:**
Push [CALL] to select the call channel.
- ④ Push [FUNC] then [7]PRIO to start the watch.
 - The transceiver receives the memory or call channel frequency every 5 sec.
 - While the watch is pausing, pushing [(VFO)CLR] resumes the watch manually
- ⑤ Push [(VFO)CLR] while the display shows the VFO frequency to stop the watch.

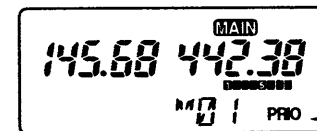

While pausing on a memory channel, "PRIO" flashes.

10 PAGER AND CODE SQUELCH

■ Pager function

This function uses DTMF codes for paging and can be used as a “message pager” to inform you of a caller’s identity even if you leave the transceiver temporarily unattended.

Personal calls and group calls are available with the pager function. Personal calls use the receiving member’s ID code for calling. The receiving member’s display shows your ID code and other members in the group know that you called. You can also call all members in your group using the group call.

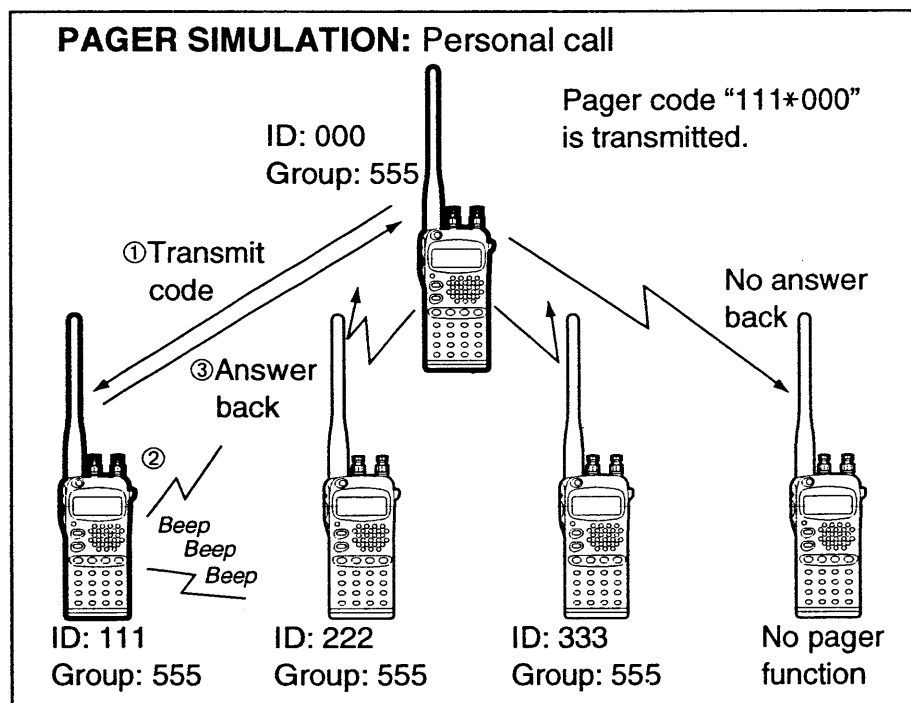

■ Code programming

◇ Before programming

The pager and code squelch functions require ID codes and a group code. These codes are 3-digit DTMF codes and must be written into the code channels before operation.

- ① Decide the ID code of each transceiver and a group code for your group.
- ② Decide whether to return to normal operation or code squelch operation after a connection is made.
- ③ Program the ID code, group code and transmit codes (other station’s ID codes) as below.

◇ Code channel assignment

| ID or group code | Code channel number | “Receive accept” or “Receive inhibit” |
|------------------------|---------------------|---|
| Your ID code | C0 | “Receive accept” only. |
| Other members ID codes | C1–C5 | “Receive inhibit” should be programmed in each channel. |
| Group code | One of C1–C5 | “Receive accept” must be programmed. |
| Memory space* | CP | “Receive inhibit” only. |

*Channel CP automatically memorizes an ID code when receiving a pager call. The contents in channel CP cannot be changed manually.

◇ Programming

- ① Select VHF or UHF with [BAND].
 - Each band has separate code channels.
- ② Push [FUNC] then [5]CODE] to select the code channel setting display.
 - Code channel CP cannot be used for programming.
- ③ Rotate [DIAL] to select the desired code channel, C0 – C5.
 - Code channel CP cannot be used for programming.
- ④ Push the numeral keys to input the desired 3-digit code.
 - Digit keys are automatically stored once the 3rd digit has been entered.
 - When a digit key is mistakenly input, push [(VFO)CLR] and enter the desired code from the beginning.
- ⑤ Push [FUNC] then [6]SKIP] to set the channel for “receive inhibit” or “receive accept.”
 - When “receive inhibit” is set, “SKIP” appears.
 - Code channel C0 cannot be set as “receive inhibit.”
 - See right for “receive accept” and “receive inhibit” details.
- ⑥ Push [PTT] to exit the setting display.

• Receive accept/receive inhibit

- “Receive accept” (“SKIP” indicator does not appear) accepts pager calls when the transceiver receives a signal with a code the same as that in the code channel.
- “Receive inhibit” (“SKIP” indicator appears) rejects calls even when the transceiver receives a code the same as that in the code channel. Transmit codes should therefore be programmed for “receive inhibit,” otherwise the transceiver will not reject unnecessary calls.

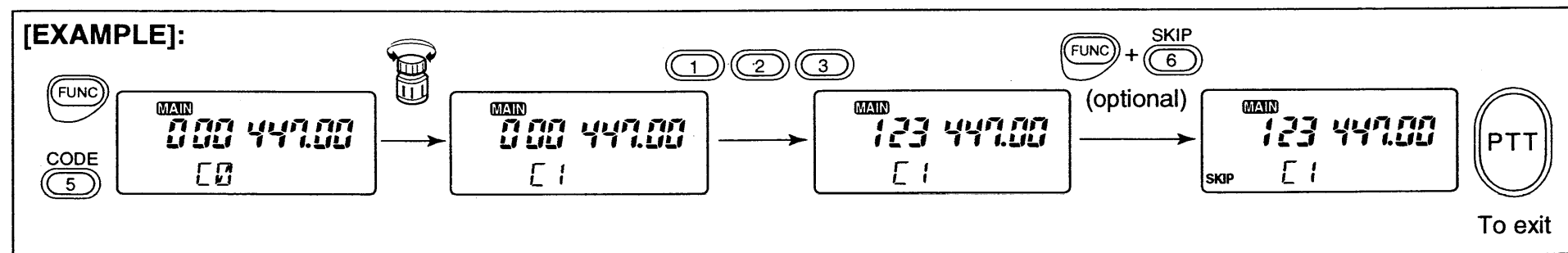

■ Pager operation

◇ Calling a specific station

- ① Program the needed code channel in advance.
- ② Select VHF or UHF with [BAND].
 - The pager function can be used on one band only.
- ③ Set the operating frequency.
- ④ Push [FUNC] then push [②PGR/CSQL] once or twice to turn the pager function ON.
 - “P” appears in place of the 100 MHz digit.
 - An optional tone squelch can be used in conjunction with the pager function.
- ⑤ Select the desired transmit code channel:
 - ➔ Push [FUNC] then [⑤CODE].
 - ➔ Rotate [DIAL] to select the channel.
 - ➔ Push [PTT] to exit the setting display.
- ⑥ Push [PTT] to transmit the pager code.
- ⑦ Wait for an answer back.
 - When the transceiver receives an answer back code, the function display shows the other members’ ID or group code.
- ⑧ After confirming a connection push [(vFo)CLR] to display the operating frequency.
 - **DO NOT** push an digit keys while code channels C0 to C5 are displayed, or code channel contents are changed.
- ⑨ Push [FUNC] then push [②PGR/CSQL] once to select the code squelch or twice to select the non-selective calling system.

◇ Waiting for a call from a specific station

- ① Select VHF or UHF with [BAND].
 - The pager function can be used on one band only.
- ② Set the operating frequency.
- ③ Push [FUNC] then push [②PGR/CSQL] once or twice to turn the pager function ON.
 - “P” appears in place of the 100 MHz digit.
 - An optional tone squelch can be used together with the pager function.
- ④ Wait for a call.
 - When receiving a call, the callers’ ID or group code, appears as shown at right.
 - Push [FUNC] to display the code channel.
 - **DO NOT** push any digit keys while code channels C0 to C5 are displayed, or code channel contents are changed.
- ⑤ Push [PTT] to send and answer back call and display the operating frequency.
- ⑥ Push [FUNC] then push [②PGR/CSQL] once to select code squelch operation or twice to select the non-selective calling system.

PERSONAL CALL

This display appears when you are called with your ID code and the calling station's ID code is 386.

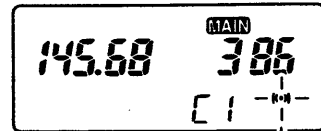

"((·))" flashes

GROUP CALL

This display appears when you are called with the group code, 123, 123 has been programmed into code channel C5.

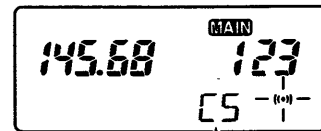

Code channel

ERROR INFORMATION

When the transceiver receives an incomplete signal, "E" appears.

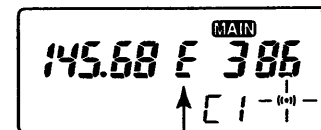

"E" appears

Code squelch

Code squelch provides communications with silent standby since you will only receive calls from stations which know your ID or group code. Each push of [PTT] sends a 3-digit code in order to open the receiving station's code squelch prior to voice transmission.

- ① Select VHF or UHF with [BAND].
 - The code squelch can be used on one band only.
- ② Set the operating frequency.
- ③ Push [FUNC] then push [ⓂPGR/CSQL] once or twice to turn the code squelch ON.
 - "C" appears in place of the 100 MHz digit.
 - An optional tone squelch can be used in conjunction with the code squelch (p. 39).
- ④ Select the desired transmit code channel:
 - Push [FUNC] then [ⓈCODE].
 - Rotate [DIAL] to select the channel.
 - Push [PTT] to exit the setting display.
- ⑤ Operate the transceiver in the normal way (push [PTT] to transmit; release [PTT] to receive).
- ⑥ To cancel the code squelch, push [FUNC] then push [ⓂPGR/CSQL].
 - "C" disappears and the 100 MHz digit returns to the display.

11 MESSAGE FUNCTION

■ General

6-digit alphanumeric “messages” can be transmitted or received together with the pager or code squelch function. This function may be useful when there is no answer back from the desired station and you want to leave a message.

The transceiver has 10 message memories each for receive and transmit, to memorise and send messages, respectively. There are 2 methods to transmit a message: manual transmission or automatic transmission of preprogrammed transmit memories.

◇ Message characters

| | | | | |
|---------|-------------|-------------|-------------|-------------|
| 0 : [0] | A : [2]+[A] | K : [5]+[B] | U : [8]+[B] | + : [0]+[C] |
| 1 : [1] | B : [2]+[B] | L : [5]+[C] | V : [8]+[C] | - : [1]+[D] |
| 2 : [2] | C : [2]+[C] | M : [6]+[A] | W : [9]+[A] | = : [2]+[D] |
| 3 : [3] | D : [3]+[A] | N : [6]+[B] | X : [9]+[B] | * : [3]+[D] |
| 4 : [4] | E : [3]+[B] | O : [6]+[C] | Y : [9]+[C] | / : [4]+[D] |
| 5 : [5] | F : [3]+[C] | P : [7]+[A] | Z : [1]+[B] | Δ : [5]+[D] |
| 6 : [6] | G : [4]+[A] | Q : [1]+[A] | (space) | μ : [6]+[D] |
| 7 : [7] | H : [4]+[B] | R : [7]+[B] | : [1]+[C] | Σ : [7]+[D] |
| 8 : [8] | I : [4]+[C] | S : [7]+[C] | < : [0]+[A] | :: [8]+[D] |
| 9 : [9] | J : [5]+[A] | T : [8]+[A] | > : [0]+[B] | |

■ Message programming

- ① Push [MSG] 2 times to select a transmit message memory.
 - One of “t0” to “t9” appears.
- ② Rotate [DIAL] to select the desired memory.
 - The [▽] or [Δ] keys can also be used.
- ③ Push [FUNC] then [8]SET to enter message writing mode.
 - The first character of the message flashes.
 - “-” appears in the case of an unprogrammed memory.
- ④ Rotate [DIAL] to select the desired first character.
 - See the table at left for available characters.
- ⑤ Push [Δ] to select the next digit for input; then rotate [DIAL] to select a character.
 - [▽] selects the previous digit.
- ⑥ Repeat step ⑤ until the desired message is input.
 - 6 characters is the maximum for a message.
- ⑦ Push [M•N] to complete the programming.
- ⑧ Push [(VFO)CLR] to exit the message memory.

NOTE: Message memory channel t0 is used for the opening message at power ON and “ICOM” is programmed as the default setting.

[EXAMPLE]:

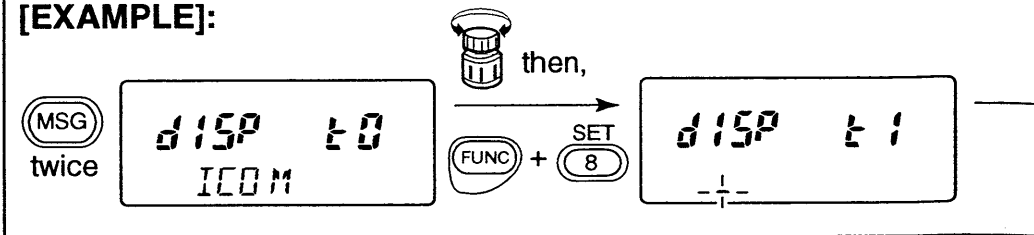

■ Operation

◇ Message standby (receive)

- ① Set the transceiver for pager or code squelch operation.
 - Remember that pager code programming, etc. for each transceiver in the group is necessary.
- ② Push [FUNC] then [MSG].
 - “MSG” appears.
- ③ When receiving a signal with a message, the message is programmed into receive message channel “r0” and indicated.
 - Previous messages are shifted to the next higher memory.
- ④ To confirm the previous message, rotate [DIAL] to select the appropriate receive message memory.
- ⑤ Push [(VFO)CLR] to return to frequency indication.

◇ Clearing a message

- ① Push [MSG] once or twice to select a receive message channel.
 - Transmit message channels cannot be cleared simultaneously.
- ② Push [FUNC] then push and hold [(RPT•M)MCL].
 - All receive messages, “r0” to “r9,” are cleared.

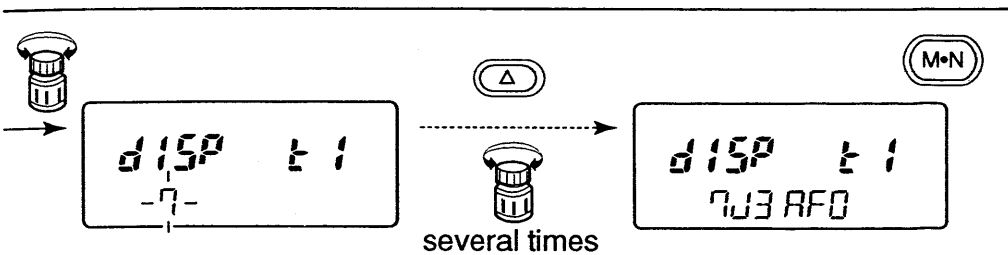

◇ Message transmission

• Memory transmission

- ① Set the transceiver for pager or code squelch operation.
- ② Push [FUNC] then [MSG].
 - “MSG” appears.
- ③ Push and hold [PTT].
 - The pager or code squelch code is transmitted.
- ④ While continuing to push [PTT], push [MSG], then push the corresponding digit key for the transmit message memory.
 - “0” to “9” correspond to transmit message memories “t0” to “t9,” respectively.

• Manual transmission

- ① Set the transceiver for pager or code squelch operation.
- ② Push [FUNC] then [MSG].
 - “MSG” appears.
- ③ Push and hold [PTT].
 - The pager or code squelch code is transmitted.
- ④ While continuing to push [PTT], push [Δ#], then push the corresponding digit keys for the desired message.
 - Refer to the table on the previous page for details.
- ⑤ When the desired message has been input, push [Δ#] to signal the end of the transmission.

[EXAMPLE]:

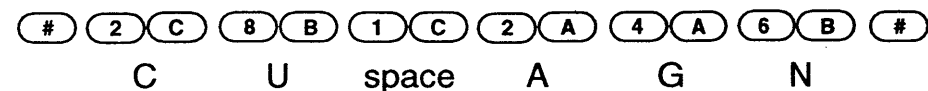

■ General

Functions described in this section require an optional UT-94 TONE SQUELCH UNIT. This unit is built-in to the U.S.A. version. The UT-94 provides tone decoder capabilities allowing you to operate tone squelch, tone scan and pocket beep functions. Refer to p. 47 for unit installation, if necessary.

Note:

- The UT-94 is capable of detecting 50 different tone frequencies and consequently their spacing is narrow compared with units having only 38 tones. Therefore, some tone frequencies may receive interference from adjacent tone frequencies.
- The UT-94 has only one decoder circuit designed for use on both bands. Therefore, when using the tone squelch on both bands and receiving strong signals (over full scale on the S-meter) on one band, the tone squelch may not open or close as normally expected.

■ Tone squelch operation

The tone squelch opens only when receiving a signal with same pre-programmed subaudible tone. You can silently wait for a call from group members using the same tone.

- ① Select VHF or UHF with [BAND].
- ② Set the operating frequency.
- ③ Set the desired subaudible tone in set mode.
 - See p. 21 for a list of available tones and programming information.
- ④ Push [FUNC] then push [①T/TSQL] several times until "T SQL" appears in the function display.
 - The code squelch can be used in conjunction with the tone squelch (p. 36).
- ⑤ When the received signal includes the correct tone, the squelch opens and the signal cannot be heard.
 - When the received signal includes an incorrect tone, the squelch does not open, however, the receive indicator lights green.
 - To open the main band squelch manually, push and hold [MONI].
- ⑥ Operate the transceiver in the normal way (push [PTT] to transmit; release [PTT] to receive).
- ⑦ To cancel the tone squelch, push [FUNC] then [①T/TSQL].
 - "TSQL" disappears from the display.

▷ CONVENIENT

Each memory and call channel stores a subaudible tone frequency and tone squelch ON/OFF settings independently (pocket beep ON cannot be stored). Simply recall a memory or call channel containing the desired settings when needed.

■ Tone scan

The transceiver can detect the subaudible tone frequency in a received signal. By monitoring a signal that is being transmitted on a repeater input frequency, you can determine the tone frequency required to access the repeater.

- ① Select the desired band with [BAND].
- ② Select VFO mode with [VFO].
 - Tone scan cannot be used in memory mode.
- ③ Set the desired frequency to be checked for a tone frequency.
- ④ Push [FUNC] then push [①T/TSQL] several times until "TSQL" appears in the function display.
- ⑤ Push [FUNC] then [③T SCAN] to start the tone scan.
 - To change the scanning direction, rotate [DIAL].
 - Be sure the pager or code squelch is not activated in advance (pgs. 35, 36).
- ⑥ When the tone frequency is matched, the squelch opens and the tone frequency is programmed into the VFO.
- ⑦ Push [(VFO)CLR] to stop the scan.

Subaudible tone frequencies flash as they are scanned.

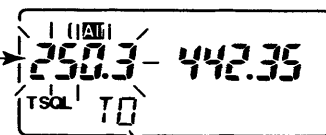

"TO" appears during tone scan

■ Pocket beep operation

This function uses subaudible tones for calling and can be used as a "common pager" to inform you that someone has called while you were away from the transceiver.

◇ Waiting for a call from a specific station

- ① Select VHF or UHF with [BAND].
- ② Set the operating frequency.
- ③ Set the desired subaudible tone in set mode.
 - See p. 21 for a list of available tone frequencies and programming information.
- ④ Push [FUNC] then push [①T/TSQL] several times until "T SQL ((•))" appears in the function display.
 - The pocket beep function cannot be used in combination with the pager or code squelch (pgs. 35, 36).
- ⑤ When a signal with the correct tone is received, the transceiver emits beep tones for 30 sec. and flashes "T SQL ((•))."
- ⑥ Push [PTT] to answer or push [(VFO)CLR] to stop the beeps and flashing.
 - Tone squelch is automatically selected.

◇ Calling a waiting station using pocket beep

A subaudible tone matched with the station's tone frequency is necessary. Use the tone squelch at right or a subaudible tone encoder.

13 OTHER FUNCTIONS

■ Battery voltage indication

The transceiver has a battery capacity indicator so that you can monitor the connected batteries' voltage level. This function is designed to show dry cell battery consumption in the BP-170 BATTERY CASE. When using Ni-Cd battery packs, such as the BP-171, voltage is measured; however, for practical purposes, the indicated value is not useful. This is because once the voltage begins to decrease, it will decrease rapidly as a result of the Ni-Cd battery characteristics.

- ① Push [FUNC] then [(H/L)BATT] to indicate the current voltage.

- A current between 4.5 and 15.5 in 0.5 V steps is indicated in the display.

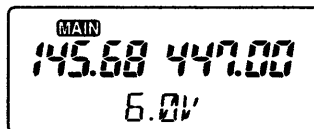

- ② When the indicator shows "LOW V," the dry cell batteries in the BP-170 may not activate the transmitter circuitry.

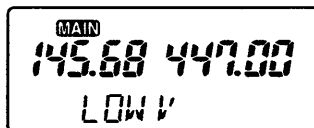

NOTE: The battery indication is only for your reference and may not be accurate.

■ Power saver

USING SET MODE

The power saver function reduces the current drain to conserve battery power. The power saver duty cycle can be set to 1 : 4, 1 : 16 or OFF. Setting it to 1 : 16 conserves the most power. For packet operation, the power saver should be turned OFF to receive reliable packet data.

- ① Push [FUNC] then [ⓈSET] to enter set mode.
- ② Push [▽] or [△] until "P-SAVE" appears as shown at right.
- ③ Rotate the [DIAL] to select the desired duty cycle or to turn the function OFF.
- ④ Push [(VFO)CLR] to exit set mode.

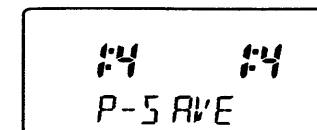

Standby: 125 msec.
Circuit off: 500 msec.

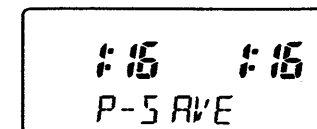

Standby: 125 msec.
Circuit off: 2 sec.

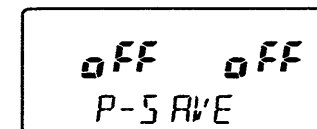

Power saver is OFF.

NOTE: When the duty cycle is set to 1 : 16, signals may be clipped up to a 2 sec. maximum.

■ Auto power-off function

USING SET MODE

The transceiver can be set to automatically turn OFF after a specified period in which no switch is pushed.

60 min., 40 min., 20 min. and OFF can be specified. The specified period is retained even when the transceiver is turned OFF by the auto power-off function. To cancel the function, select "oFF" in step ③ below.

- ① Push [FUNC] then [ⓈSET] to enter set mode.
- ② Push [▽] or [△] one or more times until "AP OFF" appears.
- ③ Rotate [DIAL] to set the desired switch action.
- ④ Push [(VFO)CLR] to exit set mode.

off off
AP OFF

20 20^{AO}
AP OFF

40 40^{AO}
AP OFF

60 60^{AO}
AP OFF

■ Dial function

USING SET MODE

The [DIAL] control functions as a "volume" control by default, or as a "tuning control" while pushing [D/V]. The primary function of the [DIAL] can be set to "tuning control" if desired.

- ① Push [FUNC] then [ⓈSET] to enter set mode.
- ② Push [▽] or [△] one or more times until "DIAL" appears.
- ③ Rotate [DIAL] to set the desired dial function priority.
- ④ Push [(VFO)CLR] to exit set mode.

Aud 10 Aud 10
DIAL

Volume control for normal use
Tuning control with [D/V]

Fr 19 Fr 19
DIAL

Tuning control for normal use
Volume control with [D/V]

NOTE: Even when the volume control (Audio) is selected, the dial activates as the tuning control when:

- Set mode is selected.
- Dial select tuning is in use (when "D" appears).
- Tuning step setting condition is selected.
- Memory writing condition is selected.
- Message, pager code, name writing, etc. is selected.

13 OTHER FUNCTIONS

■ LCD contrast

USING SET MODE

The LCD (Liquid Crystal Display) contrast can be selected from 1 of 4 levels. Select a contrast which gives the best readability for the ambient light conditions. "1" is the lowest contrast available and "4" is the highest contrast available.

- ① Push [FUNC] then [ⓈSET] to enter set mode.
- ② Push [▽] or [△] one or more times until "LCD" appears.
- ③ Rotate [DIAL] to set the desired contrast.
- ④ Push [(VFO)CLR] to exit set mode.

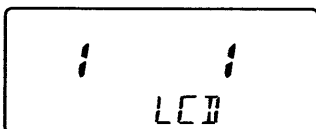
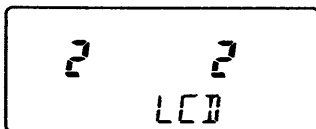
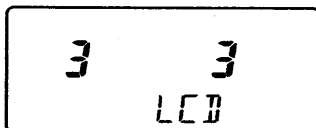
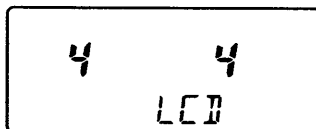

■ PTT lock function

USING SET MODE

The PTT lock function locks the PTT switch electronically to prevent accidental transmission.

- ① Push [FUNC] then [ⓈSET] to enter set mode.
- ② Push [▽] or [△] one or more times until "PTTLK" appears.
- ③ Rotate [DIAL] to set the PTT lock function ON or OFF.
- ④ Push [(VFO)CLR] to exit set mode.

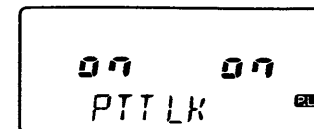
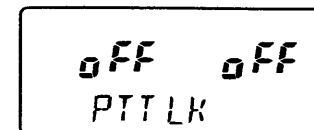

■ Optional HM-75A functions

When using an optional HM-75A with the transceiver, the switches on the HM-75A function as follows:

① A SWITCH

Toggles the main band between VHF and UHF.

② B SWITCH

Changes mode between VFO and memory.

③ Δ/▽ SWITCHES

➔ Change the frequency in the selected tuning steps in VFO mode.

➔ Change memory channel in memory mode.

➔ Start full scan or memory scan when pushed for 1 sec.

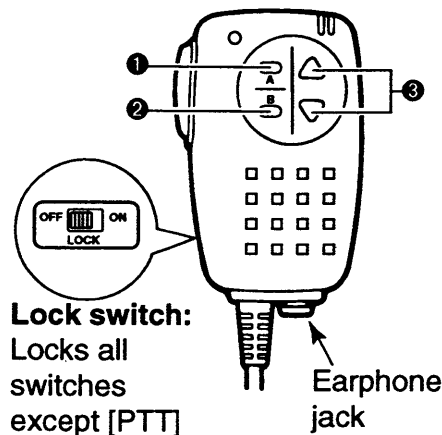

CAUTION: When connecting the HM-75A to the transceiver, make sure that power to the transceiver is turned OFF, otherwise the CPU may malfunction.

■ Partial reset

AT POWER ON

If you want to initialize the operating conditions (VFO frequency, VFO settings, set mode contents) without clearing the memory contents and repeater memories, a partial resetting function is available for the transceiver.

➔ While pushing [(VFO)CLR], turn power ON to partially reset the transceiver.

■ All reset

AT POWER ON

Reset the CPU before operating the transceiver for the first time, or when the internal CPU malfunctions.

➔ While pushing [VFO], [▽] and [MONI], turn power ON to reset the CPU.

CAUTION: Resetting the CPU returns all programmed contents to their default settings.

14 OPTIONAL UT-94 TONE SQUELCH UNIT

■ Optional UT-94 installation

An optional UT-94 TONE SQUELCH UNIT is available for this transceiver. The UT-94 provides tone scan, tone squelch and pocket beep functions.

/// The UT-94 is already built-in to the U.S.A. version.

- ① Turn power OFF, then remove the battery pack and/or DC power cable.

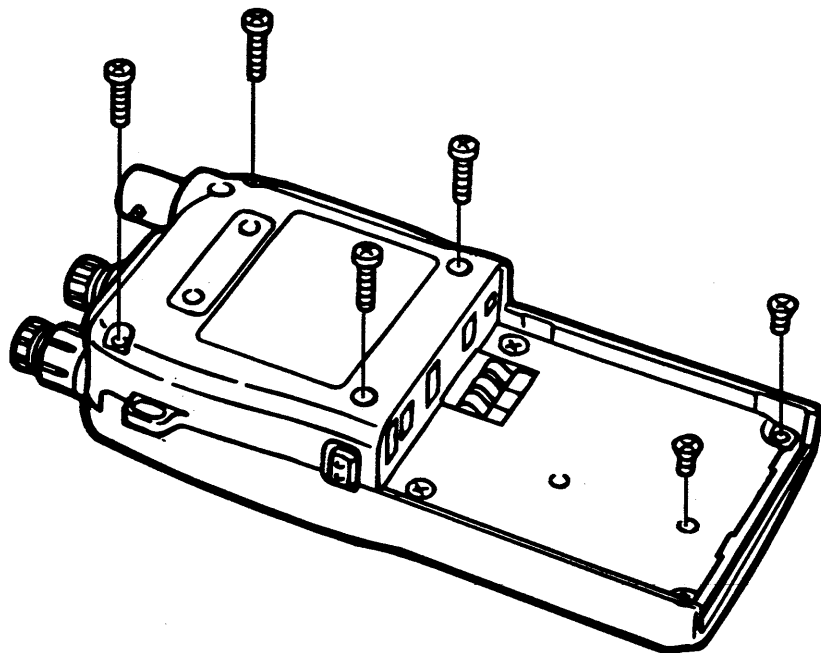

- ③ Carefully separate the front and rear panels as shown below.
- ④ Plug in the UT-94 as shown below.

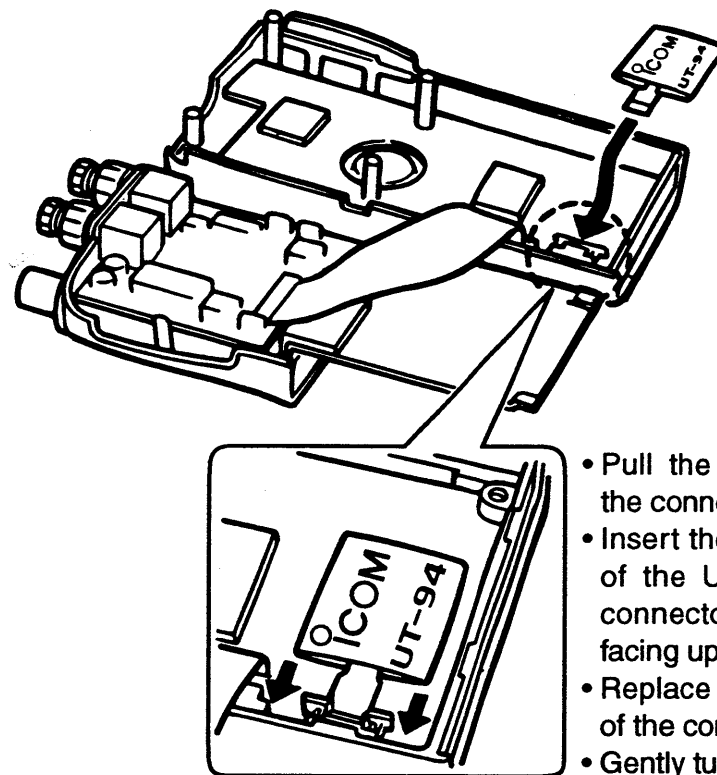

- Pull the white part of the connector.
- Insert the ribbon cable of the UT-94 into the connector (silver end facing upwards).
- Replace the white part of the connector.
- Gently tug on the UT-94 to confirm that it has been correctly installed.

- ⑤ Reassemble the front and rear panels; then, replace the 6 screws removed in step ②.

TROUBLESHOOTING 15

If your transceiver seems to be malfunctioning, please check the following points before sending it to a service center.

| PROBLEM | POSSIBLE CAUSE | SOLUTION | REF. |
|---|--|--|---------------------------------|
| <ul style="list-style-type: none"> No power comes on. | <ul style="list-style-type: none"> The battery is exhausted. (A slight current flows in the circuits even when the power is OFF). Poor plug connection to the external DC power cable. | <ul style="list-style-type: none"> Charge the battery pack or place new dry cell batteries in the battery case. (Remove the battery pack if you will not be using the transceiver for a long time.) Check the connector or remove and replace the cable. | <p>pgs. 10, 11</p> <p>—</p> |
| <ul style="list-style-type: none"> No sound comes from the speaker. | <ul style="list-style-type: none"> [SQL] is turned too far clockwise. Pager or code squelch is activated. | <ul style="list-style-type: none"> Rotate [SQL] counterclockwise. Push [FUNC] then [PGR/CSQL] once or twice to turn the function OFF. | <p>p. 17</p> <p>pgs. 35, 36</p> |
| <ul style="list-style-type: none"> Transmitting is impossible. | <ul style="list-style-type: none"> The battery is exhausted. PTT lock function is activated. | <ul style="list-style-type: none"> Charge the battery pack or place new dry cells in the battery case. Turn the function OFF. | <p>pgs. 10, 11</p> <p>p. 43</p> |
| <ul style="list-style-type: none"> Frequency cannot be set. | <ul style="list-style-type: none"> Memory mode, call channel or repeater memory is selected. The lock function is activated. | <ul style="list-style-type: none"> Push [VFO] to select VFO mode. Push [FUNC] then [(CALL)LOCK] to deactivate the lock function. | <p>p. 13</p> <p>p. 13</p> |
| <ul style="list-style-type: none"> Cannot receive "messages". | <ul style="list-style-type: none"> Pager or code squelch is not activated and/or the message function is not activated. | <ul style="list-style-type: none"> Activate pager or code squelch with [FUNC] then [PGR/CS] in advance. | <p>pgs. 35, 36</p> |
| <ul style="list-style-type: none"> Scan cannot be activated. | <ul style="list-style-type: none"> The squelch is open. | <ul style="list-style-type: none"> Rotate [SQL] clockwise until noise disappears. | <p>p. 17</p> |
| <ul style="list-style-type: none"> Auto power-off setting is erased. | <ul style="list-style-type: none"> The internal backup battery is exhausted because no charging has been performed for a long time. | <ul style="list-style-type: none"> Reset the auto power-off function again, then charge the battery pack or place new dry cells in the battery case. | <p>pgs. 42, 10, 11</p> |

16 MODE ARRANGEMENT

Although the following chart refers mainly to the VHF band, the same mode arrangement applies to the UHF band.

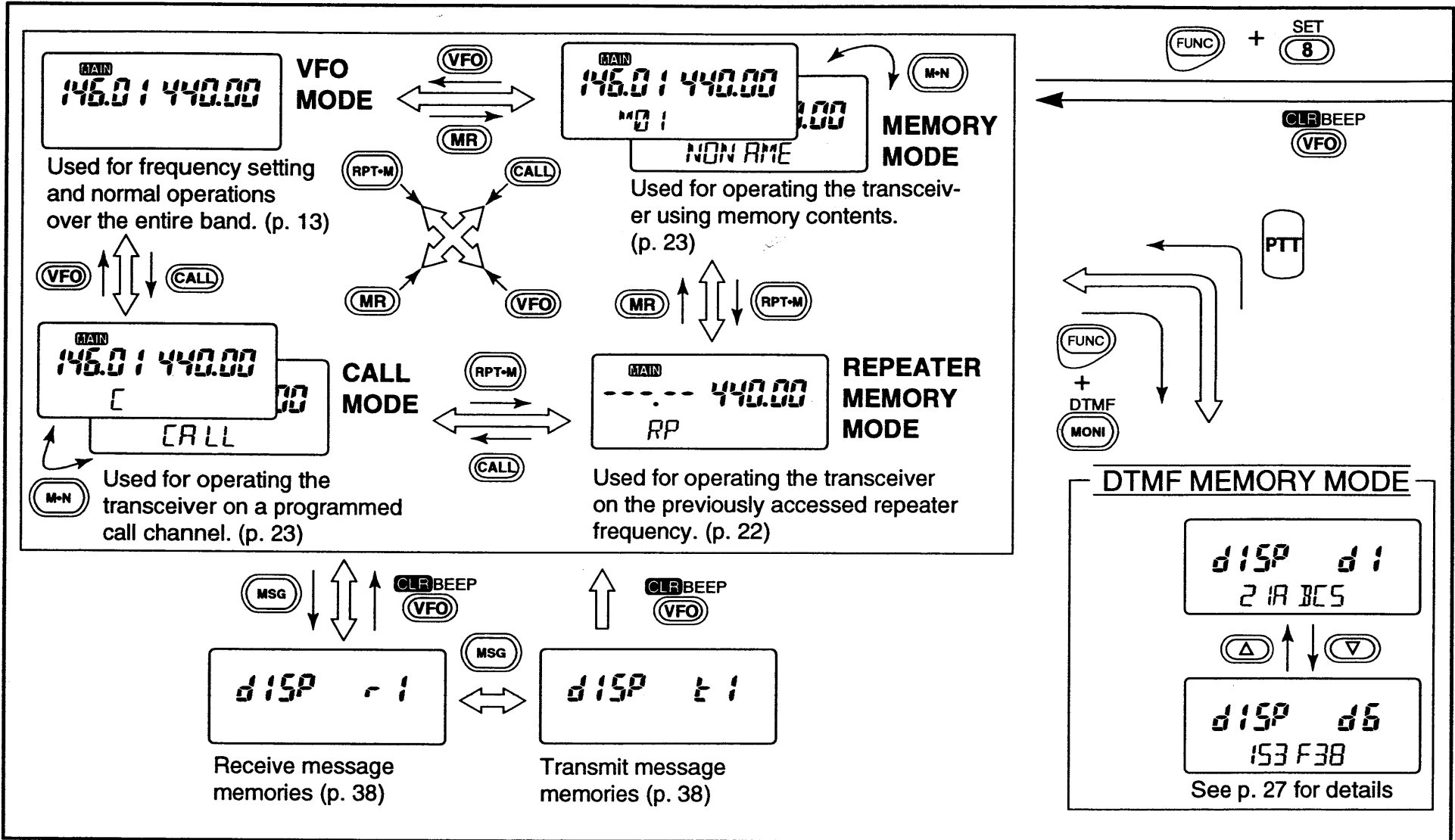

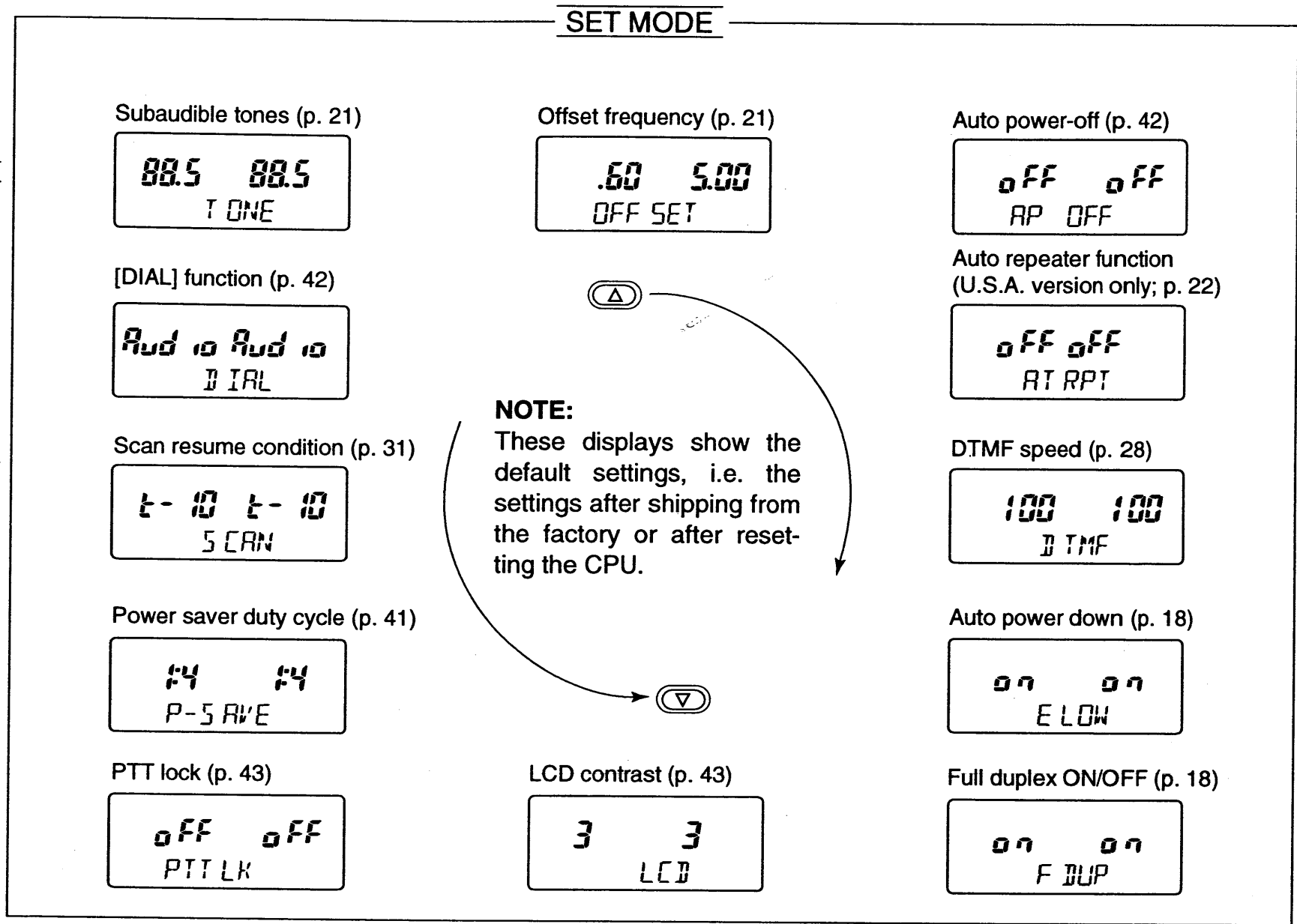

17 SPECIFICATIONS

| | | VHF | | UHF | |
|--|---|---|--|--|--|
| | | U.S.A. | Tx: 144–148 Rx: 136–174* ¹ | Tx: 440–450 Rx: 400–470* ² | Tx: 430–440 Rx: 400–470* ³ |
| Frequency coverage (MHz) | Eur. | 144–146 | | 430–440 | |
| | Asia | Tx: 144–148 Rx: 140–150* ¹ | | 430–440 | |
| | Italy | Tx: 144–148 Rx: 136–174* ¹ | | Tx: 430–440 Rx: 400–470* ³ | |
| | Guaranteed range: * ¹ 144–148 * ² 440–450 * ³ 430–440 | | | | |
| | Mode | | FM (F3E) | | |
| Frequency stability | | ± 5 ppm (0°C to +50°C; +32°F to +122°F) | | | |
| Tuning steps | | 5, 10, 12.5, 15, 20, 25, 30 or 50 kHz | | | |
| Antenna impedance | | 50 Ω (unbalanced) | | | |
| Usable battery pack/case | | See options on page at right. | | | |
| External DC power | | 4.5 to 16 V DC (negative ground) | | | |
| Current drain (at 13.5 V, typical) | Tx | High | 1.3 A | 1.5 A | |
| | | Low | 500 mA | 600 mA | |
| | 1 band Rx | Rated audio | 160 mA | 170 mA | |
| | | Power saved | 15 mA (average) | 19 mA (average) | |
| 2 bands Rx | Rated audio | 210 mA | | | |
| | Power saved | 28 mA (average) | | | |
| Usable temperature range | | –10°C to +60°C (+14°F to +140°F) | | | |
| Dimensions (with BP-171) (projections not included) | | 57(W)x125(H)x31(D) mm; 2.2(W)x4.9(H)x1.2(D) in | | | |
| Weight (with BP-171 and antenna) | | 340 g; 12.0 oz | | | |

| | | VHF | | UHF | |
|-------------------------------------|------------------------------|--|----------|----------|----------|
| | | 1st | 2nd | 43.1 MHz | 35.8 MHz |
| TRANSMITTER | Output power* (at 13.5 V) | 5 W, 0.5 W, 15 mW (selectable) | | | |
| | Modulation system | Variable reactance frequency modulation | | | |
| | Max. freq. deviation* | ±5.0 kHz | | | |
| | Microphone impedance | 2 kΩ | | | |
| RECEIVER | | | | | |
| Receive system | | Double conversion superheterodyne | | | |
| Intermediate frequencies | 1st | | 43.1 MHz | 35.8 MHz | |
| | 2nd | 455 kHz | | | |
| Sensitivity* (12 dB SINAD) | | Less than 0.18 μV (Less than 0.32 μV for V/V and U/U) | | | |
| Squelch sensitivity | | Less than 0.18 μV (at threshold) | | | |
| Selectivity | | More than 15 kHz/–6 dB Less than 30 kHz/–60 dB | | | |
| Spurious and image rejection ratio* | | More than 50 dB (More than 40 dB at IF/2) | | | |
| Audio output power* (at 13.5 V) | | More than 180 mW (at 10% distortion with an 8 Ω load) | | | |
| Audio output impedance | | 8 Ω | | | |

*Specifications guaranteed at a transceiver temperature of +25°C (+77°F).

All stated specifications are subject to change without notice or obligation.

◇ Battery packs

| BATTERY PACK | HEIGHT | VOLTAGE | CAPACITY | OUTPUT POWER |
|--------------|----------------|---------------------------------------|----------|--------------|
| BP-170 | 63.5 mm/2.5 in | Battery case for R6(AA) x 4 dry cells | | 1.3 (1.5) W |
| BP-171 | 63.5 mm/2.5 in | 4.8 V | 700 mAh | 1.3 (1.5) W |
| BP-172 | 63.5 mm/2.5 in | 4.8 V | 950 mAh | 1.3 (1.5) W |
| BP-173 | 75.5 mm/3.0 in | 9.6 V | 650 mAh | 4.5 (5) W |
| BP-180 | 75.5 mm/3.0 in | 7.2 V | 600 mAh | 3.5 (3.5) W |

Bracketed values in the output power column refer to the UHF band.

◇ Chargers and cables

BC-74A/E/D, BC-110V WALL CHARGERS

Regularly charge battery packs.

BC-79 DESKTOP CHARGER + AD-51 BATTERY PACK ADAPTER

Rapidly charge battery packs in 1 to 1.5 hrs. depending on the battery pack. An AC adapter is packed with the BC-79. The AD-51 must be used with the BC-79 for charging a battery pack. The CP-13/L or OPC-288 can be used instead of the supplied AC adapter.

CP-12 CIGARETTE LIGHTER CABLE WITH NOISE FILTER

For operation and charging via a 12 V cigarette lighter socket.

OPC-254 DC POWER CABLE

For operation and charging via an external power supply.

◇ Carrying case

LC-128 CARRYING CASE

Protects the transceiver body. Fits all battery packs listed above.

◇ Speaker-microphones

HM-46



HM-54

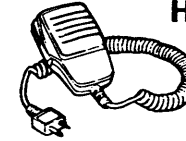

HM-75A



HS-85 HEADSET

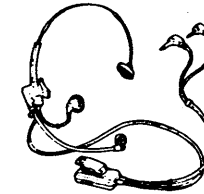

- PTT switch
- VOX
- One-touch PTT for hands-free operation

◇ Others

MB-30 MOUNTING BRACKET

When using the bracket hanger

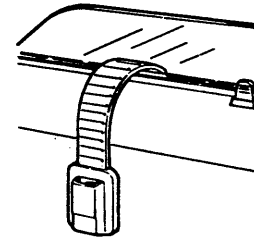

When using no bracket hanger

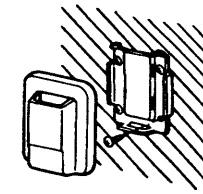

SP-13 EARPHONE

Provides clear receive audio in noisy environments.

UT-94 TONE SQUELCH UNIT

Provides a "personalized" tone squelch system, and calling system for pocket beep operation, with other stations. A tone scan is also available to decode subaudible tone frequencies. The U.S.A. version includes this unit as standard.

Count on us!



A-5339S-1EX-②
Printed in Japan
Copyright © 1995 by Icom Inc.

Icom Inc.
6-9-16 Kamihigashi, Hirano-ku, Osaka 547 Japan