



INSTRUCTION MANUAL

UHF TRANSCEIVER
ID-31A
UHF TRANSCEIVER
ID-31E

This device complies with Part 15 of the FCC Rules. Operation is subject to the following two conditions: (1) this device may not cause harmful interference, and (2) this device must accept any interference received, including interference that may cause undesired operation.

WARNING: MODIFICATION OF THIS DEVICE TO RECEIVE CELLULAR RADIOTELEPHONE SERVICE SIGNALS IS PROHIBITED UNDER FCC RULES AND FEDERAL LAW.

Icom Inc.

The photo shows the ID-31E version.



FOREWORD

Thank you for purchasing this fine Icom product. The ID-31A or ID-31E UHF TRANSCEIVER is designed and built with Icom's superior technology and craftsmanship combining traditional analog technologies with the new digital technology, Digital Smart Technologies for Amateur Radio (D-STAR), for a balanced package. With proper care, this product should provide you with years of trouble-free operation.

We thank you for making your ID-31A or ID-31E your radio of choice, and hope you agree with Icom's philosophy of "technology first." Many hours of research and development went into the design of your ID-31A or ID-31E.

IMPORTANT

READ ALL INSTRUCTIONS carefully and completely before using the transceiver.

SAVE THIS INSTRUCTION MANUAL— This instruction manual contains important operating instructions for the ID-31A/ID-31E.

FEATURES

- *Built-in GPS receiver*
- *GPS Logger function allows you to check your route as you move*
- *microSD card slot ready for several memory storage*
- *Voice recorder to records your communication*
- *Waterproof construction (IPX7*)*
*Only when the BP-271 or BP-272 battery pack, antenna and jack cover are attached.
- *DV mode (Digital voice + Low-speed data communication) operation-ready*
 - *Text message and call sign exchange*
 - *Transmit position data*
- *DR (D-STAR Repeater) mode and repeater list allow you to easily operate using a D-STAR repeater*

Spurious signals may be received in the DV mode near the following frequencies. These are made in the internal circuit and does not indicate a transceiver malfunction.
430.080 MHz, 442.370 MHz

EXPLICIT DEFINITIONS

WORD	DEFINITION
⚠ DANGER!	Personal death, serious injury or an explosion may occur.
⚠ WARNING!	Personal injury, fire hazard or electric shock may occur.
CAUTION	Equipment damage may occur.
NOTE	Recommended for optimum use. No risk of personal injury, fire or electric shock.

• For customers in California (U.S.A.)

This product uses a Coin Lithium Battery which contains Perchlorate Material—special handling may apply.

See <http://www.dtsc.ca.gov/hazardouswaste/perchlorate>

FCC INFORMATION

• FOR CLASS B UNINTENTIONAL RADIATORS:

This equipment has been tested and found to comply with the limits for a Class B digital device, pursuant to part 15 of the FCC Rules. These limits are designed to provide reasonable protection against harmful interference in a residential installation. This equipment generates, uses and can radiate radio frequency energy and, if not installed and used in accordance with the instructions, may cause harmful interference to radio communications. However, there is no guarantee that interference will not occur in a particular installation. If this equipment does cause harmful interference to radio or television reception, which can be determined by turning the equipment off and on, the user is encouraged to try to correct the interference by one or more of the following measures:

- Reorient or relocate the receiving antenna.
- Increase the separation between the equipment and receiver.
- Connect the equipment into an outlet on a circuit different from that to which the receiver is connected.
- Consult the dealer or an experienced radio/TV technician for help.

CAUTION: Changes or modifications to this device, not expressly approved by Icom Inc., could void your authority to operate this device under FCC regulations.

PRECAUTIONS

⚠ **DANGER! NEVER** short the terminals of the battery pack.

⚠ **DANGER!** Use and charge only specified Icom battery packs with Icom radios or Icom chargers. Only Icom battery packs are tested and approved for use with Icom radios or charged with Icom chargers. Using third-party or counterfeit battery packs or chargers may cause smoke, fire, or cause the battery to burst.

⚠ **WARNING RF EXPOSURE!** This device emits Radio Frequency (RF) energy. Caution should be observed when operating this device. If you have any questions regarding RF exposure and safety standards, please refer to the Federal Communications Commission Office of Engineering and Technology's report on Evaluating Compliance with FCC Guidelines for Human Radio Frequency Electromagnetic Fields (OET Bulletin 65).

⚠ **WARNING! NEVER** hold the transceiver so that the antenna is very close to, or touching exposed parts of the body, especially the face or eyes, while transmitting. The transceiver will perform best if the microphone is 5 to 10 cm (2 to 4 inches) away from the lips and the transceiver is vertical.

⚠ **WARNING! NEVER** operate the transceiver with an earphone, headphones or other audio accessories at high volume levels. Hearing experts advise against continuous high volume operation. If you experience a ringing in your ears, reduce the volume level or discontinue use.

⚠ **WARNING! NEVER** operate the transceiver while driving a vehicle. Safe driving requires your full attention—anything less may result in an accident.

⚠ **WARNING! NEVER** connect the transceiver to a power source of more than 16 V DC or use reverse polarity. This could cause a fire or damage the transceiver.

⚠ **WARNING! NEVER** operate or touch the transceiver with wet hands. This may result in an electric shock or may damage the transceiver.

CAUTION: MAKE SURE the flexible antenna and battery pack are securely attached to the transceiver, and that the antenna and battery pack are dry before attachment. Exposing the inside of the transceiver to water will result in serious damage to the transceiver.

After exposure to water, clean the battery contacts thoroughly with fresh water and dry them completely to remove any water or salt residue.

PRECAUTIONS

CAUTION: DO NOT use harsh solvents such as benzene or alcohol to clean the transceiver, because they can damage the transceiver's surfaces.

DO NOT operate the transceiver near unshielded electrical blasting caps or in an explosive atmosphere.

DO NOT push the PTT unless you actually intend to transmit.

BE CAREFUL! The transceiver will become hot when operating it continuously for long periods of time.

DO NOT use or place the transceiver in direct sunlight or in areas with temperatures below -20°C (-4°F) or above $+60^{\circ}\text{C}$ ($+140^{\circ}\text{F}$).

Place the unit in a secure place to avoid inadvertent use by children.

BE CAREFUL! The transceiver meets IPX7* requirements for waterproof protection. However, once the transceiver has been dropped, waterproof protection cannot be guaranteed because of possible damage to the transceiver's case or waterproof seal.

* Only when the BP-271 or BP-272 (option), flexible antenna, [MIC/SP] cap, [DATA/DC IN] cap and [micro SD] slot cap are attached.

The BP-273 meets IPX4 requirements for splash resistance. When it is connected, the transceiver corresponds to IPX4.

Even when the transceiver power is OFF, a slight current still flows in the circuits. Remove the battery pack or batteries from the transceiver when not using it for a long time. Otherwise, the installed battery pack or batteries will become exhausted, and will need to be recharged or replaced.

PRECAUTIONS (Continued)

◇ Important notes when using the GPS receiver

- The GPS signal cannot pass through metal objects. When using the ID-31A or ID-31E inside a vehicle, you may not receive GPS signals. We recommend you use it near a window. Please avoid the areas shown in the following:
 1. DO NOT use where it will block the driver's view.
 2. DO NOT use where the air bags could deploy.
 3. DO NOT use where it becomes a driving obstacle.
- The Global Positioning System (GPS) is built and operated by the U.S. Department of Defence. The Department is responsible for accuracy and maintenance of the system. Any changes by the Department may affect the accuracy and function of the GPS system.
- When the GPS receiver is activated, please do not cover the ID-31A or ID-31E with anything that will block the satellite signals.
- The GPS receiver may not work if used in the following locations:
 1. Tunnels or high-rise buildings
 2. Underground parking lots
 3. Under a bridge or viaduct
 4. In remote forested areas
 5. Under bad weather conditions (rainy or cloudy day)
- The GPS receiver may not work if the transceiver operates near the 440.205 MHz. This is made in the internal circuit and does not indicate a transceiver malfunction.

Icom, Icom Inc. and the Icom logo are registered trademarks of Icom Incorporated (Japan) in Japan, the United States, the United Kingdom, Germany, France, Spain, Russia and/or other countries.

APRS® is a registered trademark of Mr. Bob Bruninga in the U.S.A. and other countries.

Adobe and Adobe Reader are either registered trademarks or trademarks of Adobe Systems Incorporated, in the United States and/or other countries.

Microsoft, Windows and Windows Vista are registered trademarks of Microsoft Corporation in the United States and/or other countries.

ABOUT THE SUPPLIED CD

The following Guide, Instructions and Installers are included in the CD.

- **D-STAR Quick Guide**

Quick reference guide for the DR (D-STAR Repeater) mode operation, and is the same as the supplied leaflet

- **Instruction manual**

Instructions for the basic operation, the same as this manual

- **Advanced Instructions**

Instructions for the advanced operations and more details are described than in this manual.

- **HAM radio Terms**

The glossary of HAM radio terms

- **CS-31 Instruction manual**

Instructions for the CS-31 cloning software installation and use

- **CS-31 Installer**

Installer for the CS-31 cloning software

- **Adobe® Reader® Installer**

Installer for Adobe® Reader®

A PC with the following Operating System is required.

- Microsoft® Windows® 7, Microsoft® Windows Vista® or Microsoft® Windows® XP

◇ Starting the CD

- ① Insert the CD into the CD drive.
 - The Menu screen shown below is automatically displayed. If it doesn't appear, double click "Autorun.exe" in the CD.
- ② Click the desired button to open the file.
 - To close the Menu screen, click [Quit].

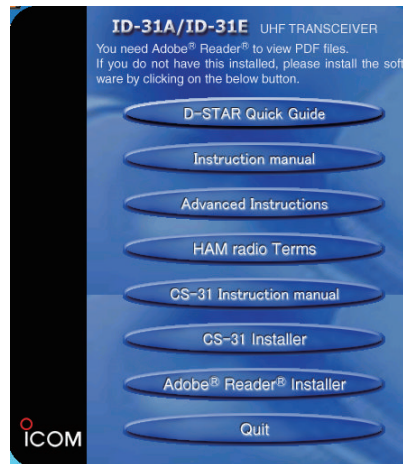

To read the guide or instructions, Adobe® Reader® is required. If you have not installed it, please install the Adobe® Reader® in the CD or downloaded it from Adobe Systems Incorporated's website.

SUPPLIED ACCESSORIES

The following accessories are supplied with the transceiver.

① Antenna	1
② Hand strap	1
③ Battery charger (BC-167SA/SD/SV)*	1
④ Belt clip	1
⑤ Battery pack (BP-271)	1
⑥ CD	1

* Not supplied, or the shape is different, depending on the transceiver version.

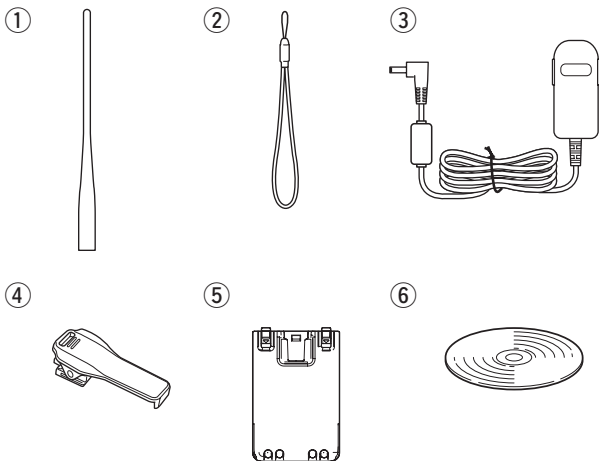

TABLE OF CONTENTS

FOREWORD	i
IMPORTANT	i
FEATURES	i
EXPLICIT DEFINITIONS	ii
FCC INFORMATION	ii
PRECAUTIONS	iii–v
ABOUT THE SUPPLIED CD	vi
SUPPLIED ACCESSORIES	vii
TABLE OF CONTENTS	vii–viii

1 ACCESSORY ATTACHMENT	1–2
■ Hand strap	1
■ Battery pack	1
■ Belt clip	2
■ Antenna	2
2 ABOUT USING A MICROSD CARD	3–4
■ About using a microSD card	3
■ Inserting the microSD card	4
■ Format the microSD card	4
3 PANEL DESCRIPTION	5–10
■ Front, top and side panels	5
■ Function display	9

TABLE OF CONTENTS

4 BATTERY CHARGING	11–18	6 MENU SCREEN OPERATION	32–49
■ Caution.....	11	■ Menu item selection	32
■ Regular charging.....	13	■ Menu items and default settings	33
■ Rapid charging.....	14	7 RESETTING	50
■ Optional battery case.....	15	■ Resetting.....	50
■ Battery information.....	17	8 TROUBLESHOOTING	51–52
■ External DC power operation.....	18	9 SPECIFICATIONS	53
5 BASIC OPERATION	19–31	10 OPTIONS	54–60
■ Power ON.....	19	■ Optional HM-75LS	
■ Setting audio volume.....	19	REMOTE CONTROL SPEAKER MICROPHONE	56
■ Setting squelch level	20	■ LC-178 CARRYING CASE	57
■ Monitor function	20	■ VOX function	58
■ Mode selection.....	21	11 COUNTRY CODE LIST	61
■ Setting a tuning step	23	INDEX	62–65
■ Setting a frequency	23		
■ Operating mode selection	24		
■ Receiving	24		
■ Transmitting.....	25		
■ Transmit power selection.....	26		
■ Key Lock function.....	26		
■ Scan function	27		

ACCESSORY ATTACHMENT

■ Hand strap

To facilitate carrying the transceiver, slide the hand strap through the loop on the top of the rear panel, as illustrated to the right.

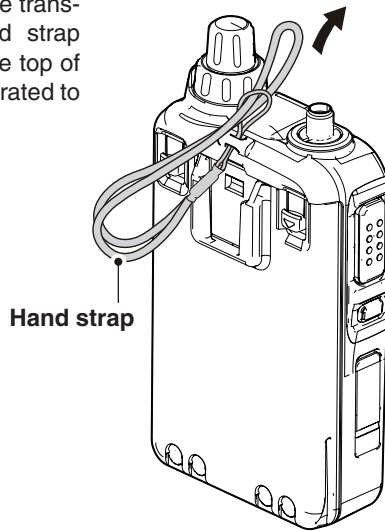

■ Battery pack

To attach or detach the battery pack:

To attach or detach the battery pack or battery case, follow the illustrations below.

To attach

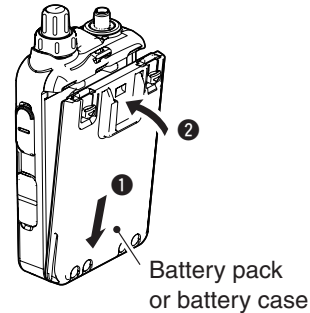

To detach

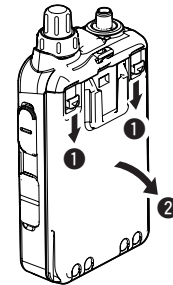

Even when the transceiver power is OFF, a small current still flows in the radio. Remove the battery pack or case from the transceiver when not using it for a long time. Otherwise, the battery pack or installed batteries will become exhausted.

The battery protection function automatically sets transceiver to Low power (0.5 W) when the temperature is 0°C (+32°F) or below. In this case, transmit power selections (High and Mid) are also disabled.

■ Belt clip

To attach the belt clip:

- ① Remove the battery pack from the transceiver, if it is attached. (p. 1)
- ② Slide the belt clip in the direction of the arrow until the belt clip locks in place, and makes a 'click' sound.

To detach the belt clip:

- ① Remove the battery pack from the transceiver, if it is attached. (p. 1)
- ② Lift the tab up (①), and slide the belt clip in the direction of the arrow (②).

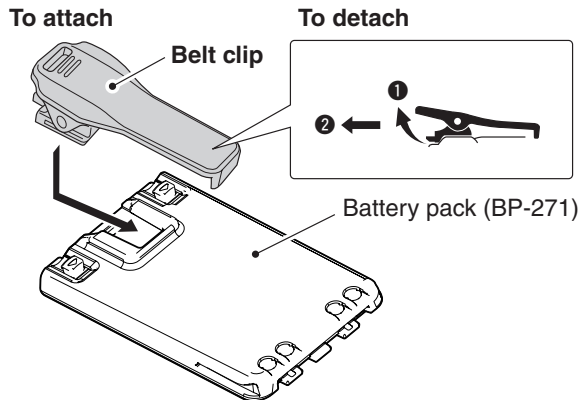

■ Antenna

Insert the antenna connector into the antenna base and tighten the antenna base.

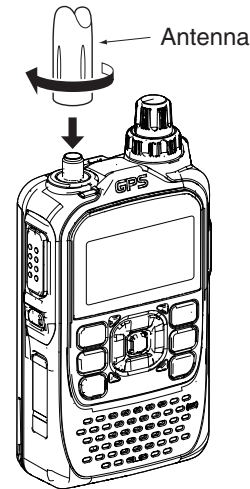

/// **NEVER** carry the transceiver by holding only the antenna.

/// ✓ **For your information**

Third-party antennas may increase transceiver performance. An optional AD-92SMA ANTENNA CONNECTOR ADAPTER is available to connect an antenna that has a BNC connector.

■ About using a microSD card

◇ Usable microSD cards

/// A microSD or microSDHC card is not supplied with the transceiver. Please purchase a desired card to use.

Icom has checked compatibility with the following microSD and microSDHC cards, shown in the table.

(As of January 2014)

Maker	Kind of the card	Capacity*
SanDisk®	microSD	2 GB
	microSDHC	4 GB
		8 GB
		16 GB
		32 GB

* If the large capacity card is used, the transceiver takes extra time to recognize the card.

/// **BE CAREFUL!** While reading or writing data from and to the card, **NEVER** turn OFF the transceiver. It will corrupt the data or damage the card.

Also be careful in the following cases:

- When using the transceiver with the BP-273 battery case, and the batteries are near exhaustion.
- When using the transceiver with an external DC power source and the battery pack is not attached, then the external power is turned OFF.

◇ Contents that can be stored onto a card

The transceiver has a slot for a microSD card to store memory contents, transceiver settings, GPS information, and other data. Following data can be stored onto the card.

- Memory channel contents
- Repeater list
- Transceiver settings
- Received communication activity (audio)
- Voice audio to use with the Auto Replay function in the DV mode
- Position and time data from a GPS receiver that is in a log file as a route

■ Inserting the microSD card

- ① Turn OFF the transceiver.
- ② Lift OFF the [micro SD] slot cover on the side panel.
- ③ With the terminals facing the front, insert the card into the slot until it locks in place, and makes a 'click' sound.

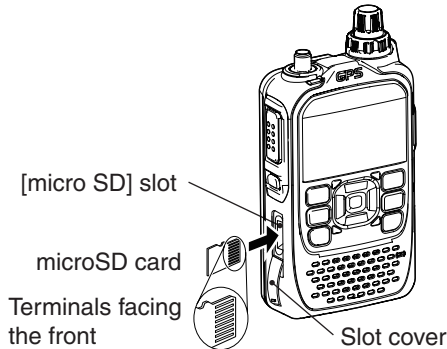

- ④ Firmly close the [micro SD] slot cover.

/// BE CAREFUL!

- **NEVER** insert the card with the terminals facing the back or **NEVER** insert it slanted. That will damage the card or the slot.
- **DO NOT** touch the terminals.
- To remove the card, push in to release it, then carefully pull the card out.
- While reading or writing data from and to the card, **NEVER** remove the card. It will corrupt the data or damage the card.

■ Format the microSD card

When using a preformatted brand new microSD card, formatting is not necessary. However, we recommend you format it in the following way to get card's best performance.

/// IMPORTANT!

Formatting a card erases all its data. Before formatting any programmed card, make a backup file onto your PC.

- ① Turn ON the transceiver.
- ② Push [MENU]  to enter the Menu screen.
- ③ Push D-pad(↑) to select the root item (SD Card), then push D-pad(Ent).

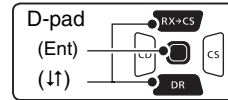

- ④ Push D-pad(↑) to select "Format," then push D-pad(Ent).
 - The confirmation screen "Format OK?" appears.
- ⑤ Push D-pad(↑) to select "YES," then push D-pad(Ent) to format.
 - The formatting starts and the display shows the formatting state.
 - After formatting, the display automatically returns to the SD CARD menu.
- ⑥ Push [MENU]  to return to the frequency display.

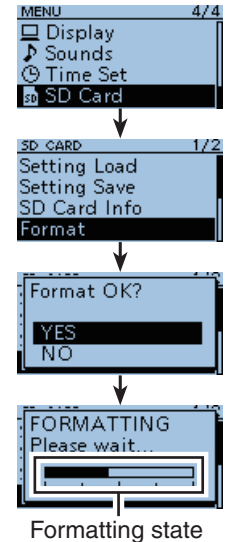

3

PANEL DESCRIPTION

■ Front, top and side panels

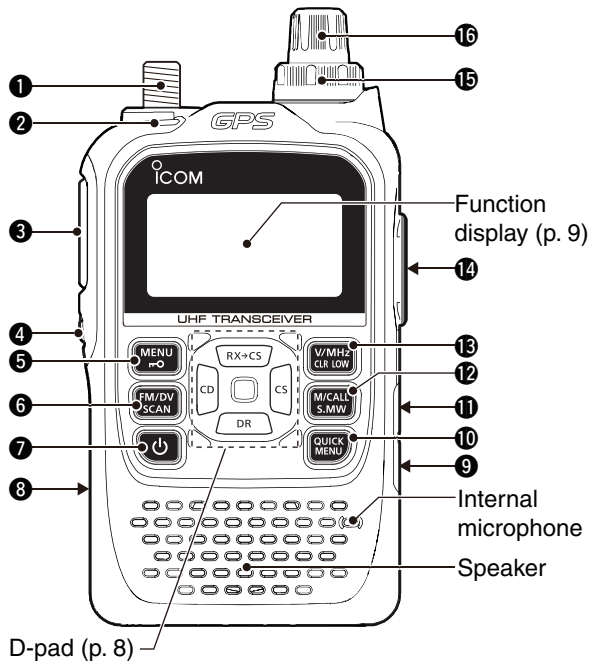

1 ANTENNA CONNECTOR (p. 2)

Connect the antenna here.

- An optional AD-92SMA adapter (p. 55) is available to connect an antenna with a BNC connector.

2 TX/RX INDICATOR [TX/RX] (pp. 24, 25)

Lights green while receiving a signal or when the squelch is open; lights red while transmitting.

3 PTT SWITCH [PTT] (p. 25)

Hold down to transmit, release to receive.

For ID-31E only

Push briefly, then hold down to transmit a 1750 Hz tone burst.

4 SQUELCH KEY [SQL] (p. 20)

- ➔ Hold down to temporarily open the squelch and monitor the operating frequency.
- ➔ While holding down this key, rotate [DIAL] to adjust the squelch level.

5 MENU • LOCK KEY [MENU - ➔ Push to enter or exit the Menu screen. (p. 32) - ➔ Hold down for 1 second to toggle the Key Lock function ON or OFF. (p. 26)

6 FM/DV • SCAN KEY [FM/DV•SCAN]



- ➔ Push to select the operating mode. (p. 24)
 - Selectable operating modes are FM, FM-N and DV.
- ➔ Hold down for 1 second to enter the scan type selection mode. (p. 27)
 - Push again to start the scan.
 - Push  to stop the scan.

7 POWER KEY []



- ➔ Hold down for 1 second to turn the transceiver power ON or OFF. (p. 19)

8 microSD CARD SLOT [micro SD] (p. 4)

Insert a microSD card of up to 32 GB SDHC.

9 EXTERNAL DC IN JACK [DC IN]

- ➔ Connects to the supplied wall charger, BC-167SA/SD/SV, to charge the attached battery pack. (p. 13)
- ➔ Connect an external DC power supply through the optional CP-12L or CP-19R cigarette lighter cable or OPC-254L DC power cable for external DC operation. (p. 18)

10 QUICK MENU KEY [QUICK MENU]



- ➔ Push to enter or exit the Quick Menu screen. (p. 32)
 - The Quick Menu is used to quickly select various functions.

11 DATA JACK [DATA]

Connects to a PC through the optional OPC-2218LU data communication cable, for low-speed data communication in the DV mode or for cloning. The jack is also used to connect an external GPS receiver. See the PDF type Advanced Instruction's Section 4 or Section 11 for more details.

12 MEMORY/CALL • SELECT MEMORY WRITE KEY [M/CALL•S.MW]



- ➔ In the VFO mode, push once to enter the Memory selection mode, push again to enter the Call channel mode. (pp. 21, 22)
- ➔ Hold down for 1 second to enter the Select Memory Write mode. (p. 28)

13 VFO/MHz • CLEAR • OUTPUT POWER KEY [VFO/MHz•CLR•LOW]



- ➔ Push to select the VFO mode. (p. 21)
- ➔ While in the VFO mode, push to select 1 MHz and 10 MHz* tuning steps. (p. 23)
 - * Depending on versions, 10 MHz tuning step is selectable.
- ➔ With the Menu screen or Quick Menu screen open, push to return to the operating mode before entering the menu screen. (pp. 32)
- ➔ While in the Memory Name or Call Sign Programming mode, push to select an upper tier menu. (See the PDF type Advanced Instruction's Section 7 for more details.)
- ➔ While scanning, push to cancel a scan. (p. 27)
- ➔ Hold down for 1 second to select the output power. (p. 26)
 - Select the transmit output power of High, Mid, Low or S-low.
 - While holding down this key, rotate [DIAL] to select the desired output power.

3 PANEL DESCRIPTION

■ Front, top and side panels (Continued)

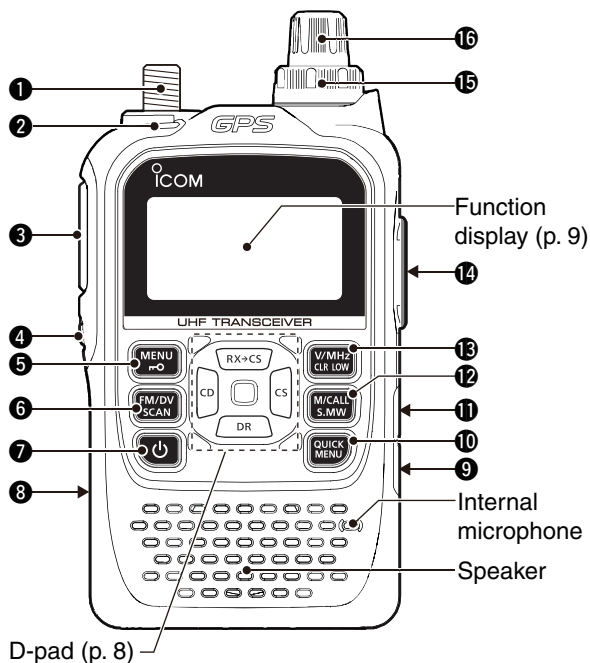

14 EXTERNAL SPEAKER/MICROPHONE JACK [SP/MIC]

Connect a cloning cable, optional speaker microphone or headset, if desired.

See page 54 for a list of available options.

Be sure to turn power OFF before connecting or disconnecting optional equipment to or from the [SP/MIC] jack.

15 VOLUME CONTROL [VOL]

Rotate to adjust the audio volume level. (p. 19)

16 CONTROL DIAL [DIAL]

➔ Rotate to select the operating frequency. (p. 23)

➔ While in the Memory mode, rotate to select a memory channel. (p. 21)

➔ While scanning, rotate to change the scanning direction. (p. 27)

➔ Hold down [SQL], and rotate to select the squelch level. (p. 20)

➔ While in the DR mode, or with the Menu screen or Quick Menu screen open, rotate to select a desired option or value. (pp. 22, 32)

◇ **D-PAD**

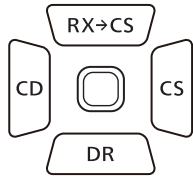

ENTER KEY [ENT]



While in the DR mode, or with the Menu screen or Quick Menu screen open, push to open or set the selected item or option. (p. 32)

RX→CS (RX CALL SIGN SET)/UP KEY [RX→CS]



➔ Hold down for 1 second to set the received call signs (station and repeaters) to operating call sign.

- While holding down this key, rotate [DIAL] select a Received Call Sign record.

➔ While in the DR mode, or with the Menu screen or Quick Menu screen open, push to move the value or option selector bar up. (p. 32)

DR (D-STAR REPEATER)/DOWN KEY [DR]



➔ Hold down 1 second to enter the DR mode. (p. 22)

➔ While in the DR mode, or with the Menu screen or Quick Menu screen open, push to move the value or option selector bar down. (p. 32)

CD (RX CALL RECORD)/LEFT KEY [CD]



➔ Hold down for 1 second to open the received calls record.

➔ While in the DR mode, or with the Menu screen or Quick Menu screen open, push to select an upper tier menu. (p. 32)

CS (CALL SIGN)/RIGHT KEY [CS]



➔ Hold down for 1 second to enter the operating call sign select mode.





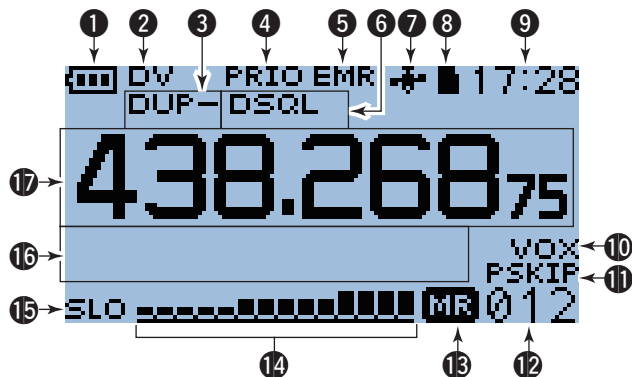

➔ While in the DR mode, or with the Menu screen or Quick Menu screen open, push to select a lower tier menu. (p. 32)

3 PANEL DESCRIPTION

■ Function display



1 BATTERY ICON (pp. 13, 17)

- “” (battery icon) appears when the battery pack is attached.
- “” appears when the battery pack must be charged.
- While charging the attached battery pack, the icon sequentially shows “,” “,” “” and “”.

2 OPERATING MODE ICONS (p. 24)

Shows the selected operating mode.

- DV, FM and FM-N are selectable.
- “DV-G” or “DV-A” appears when GPS or GPS-A transmission is selected in the DV mode. (pp. 37, 38)

3 DUPLEX ICON (p. 29)

“DUP+” appears when plus duplex is selected, and “DUP-” appears when minus duplex is selected.

4 PRIORITY WATCH ICON

Appears when Priority Watch is in use.

See the PDF type Advanced Instruction’s Section 9 for more details.

5 EMR/BK ICON

Appears when Enhanced Monitor Request (EMR) or Break-in (BK) mode is selected.

See the PDF type Advanced Instruction’s Section 4 for more details.

6 TONE ICONS

(PDF type Advanced Instruction’s Section 11)

• While operating in FM/FM-N mode:

- “TONE” appears while the Repeater Tone Encoder is ON. (p. 29)
- “TSQL” appears while the Tone squelch function is ON.
- “TSQL-R” appears while the Reverse Tone squelch function is ON.
- “DTCS” appears while the DTCS squelch function is ON.
- “DTCS-R” appears while the reverse DTCS squelch function is ON.
- “((•))” appears with the “TSQL” or “DTCS” icon while the Pocket Beep function (with CTCSS or DTCS) is ON.

• **While operating in DV mode:**

- “DSQL” appears while the Digital Call Sign squelch function is ON.
- “CSQL” appears while the Digital Code squelch function is ON.
- “(·)” appears with the “DSQL” or “CSQL” icon while the Pocket Beep function (with Digital Call Sign or Digital Code squelch) is ON.

7 GPS ICON (PDF type Advanced Instruction’s Section 5)

- Appears while GPS function is in use.
- GPS icons can be turned OFF in the GPS Set menu. (p. 36)
- Stays ON when the GPS receiver is activated and a valid position data is received.
- Blinks when an invalid position data is being received.

8 microSD ICON

(PDF type Advanced Instruction’s Section 12)
Appears while a microSD card is inserted.

9 CLOCK DISPLAY (p. 48)

Displays the current time.

10 VOX ICON (p. 59)

Appears when the VOX function is ON.

11 SKIP ICON (PDF type Advanced Instruction’s Section 8)

- “SKIP” appears when the selected memory channel is set as a skip channel.
- “PSKIP” appears when the displayed frequency is set as a skip frequency in the Memory mode.
- “PSKIP” appears while the Frequency Skip Scan function is ON in the VFO mode.

12 MEMORY CHANNEL NUMBER

- Displays the selected memory channel number. (p. 21)
- “C0” or “C1” appears when the Call channel is selected. (p. 22)

13 MEMORY ICON (pp. 21)

- Appears when the Memory mode is selected.

14 S/R F METER

- Shows the relative signal strength of the receive signal. (p. 24)
- Shows the output power level of the transmit signal. (p. 25)

15 POWER ICONS (p. 26)

- “SLO” appears when S-low power is selected.
- “LOW” appears when low power is selected.
- “MID” appears when mid power is selected.
- No icon appears when high power is selected.

16 MEMORY NAME DISPLAY

(PDF type Advanced Instruction’s Section 7)
While in the Memory mode, the programmed memory or memory bank name is displayed.

17 FREQUENCY READOUT

Displays a variety of information, such as the operating frequency, menu contents and so on.
• The decimal point blinks during a scan.

■ Caution

Misuse of Lithium-ion batteries may result in the following hazards: smoke, fire, or the battery may rupture. Misuse can also cause damage to the battery or degradation of battery performance.

- ⚠ **DANGER! NEVER** short the terminals (or charging terminals) of the battery pack. Also, current may flow into nearby metal objects such as a key, so be careful when placing battery packs (or the transceiver) in bags, etc. Simply carrying with or placing near metal objects such as a necklace, etc. may cause shorting. This may damage not only the battery pack, but also the transceiver.
- ⚠ **DANGER!** Use and charge only specified Icom battery packs with Icom radios or Icom chargers. Only Icom battery packs are tested and approved for use with Icom radios or charged with Icom chargers. Using third-party or counterfeit battery packs may cause smoke, fire, or cause the battery to burst.

◇ Battery caution

- ⚠ **DANGER! DO NOT** hammer or otherwise impact the battery. Do not use the battery if it has been severely impacted or dropped, or if the battery has been subjected to heavy pressure. Battery damage may not be visible on the outside of the case. Even if the surface of the battery does not show cracks or any other damage, the cells inside the battery may rupture or catch fire.

- ⚠ **DANGER! NEVER** use or leave battery pack in areas with temperatures above +60°C (+140°F). High temperature buildup in the battery, such as could occur near fires or stoves, inside a sun heated car, or in direct sunlight may cause the battery to rupture or catch fire. Excessive temperatures may also degrade battery performance or shorten battery life.
- ⚠ **DANGER! DO NOT** expose the battery to rain, snow, seawater, or any other liquids. Do not charge or use a wet battery. If the battery gets wet, be sure to wipe it dry before using.
- ⚠ **DANGER! NEVER** incinerate a used battery pack since internal battery gas may cause it to rupture, or may cause an explosion.
- ⚠ **DANGER! NEVER** solder the battery terminals, or **NEVER** modify the battery pack. This may cause heat generation, and the battery may burst, emit smoke or catch fire.
- ⚠ **DANGER!** Use the battery only with the transceiver for which it is specified. Never use a battery with any other equipment, or for any purpose that is not specified in this instruction manual.
- ⚠ **DANGER!** If fluid from inside the battery gets in your eyes, blindness can result. Rinse your eyes with clean water, without rubbing them, and see a doctor immediately.

- **WARNING!** Immediately stop using the battery if it emits an abnormal odor, heats up, or is discolored or deformed. If any of these conditions occur, contact your Icom dealer or distributor.
- **WARNING!** Immediately wash, using clean water, any part of the body that comes into contact with fluid from inside the battery.
- **WARNING! NEVER** put the battery in a microwave oven, high-pressure container, or in an induction heating cooker. This could cause a fire, overheating, or cause the battery to rupture.
- **CAUTION:** Always use the battery within the specified temperature range, -20°C to $+60^{\circ}\text{C}$ (-4°F to $+140^{\circ}\text{F}$). Using the battery out of its specified temperature range will reduce the battery's performance and battery life.
- **CAUTION:** Shorter battery life could occur if the battery is left fully charged, completely discharged, or in an excessive temperature environment (above $+50^{\circ}\text{C}$; $+122^{\circ}\text{F}$) for an extended period of time. If the battery must be left unused for a long time, it must be detached from the radio after discharging. You may use the battery until the battery indicator shows half-capacity, then keep it safely in a cool dry place at the following temperature range:
 - 20°C (-4°F) to $+50^{\circ}\text{C}$ ($+122^{\circ}\text{F}$) (within a month).
 - 20°C (-4°F) to $+35^{\circ}\text{C}$ ($+95^{\circ}\text{F}$) (within three months).
 - 20°C (-4°F) to $+20^{\circ}\text{C}$ ($+68^{\circ}\text{F}$) (within a year).

◇ Charging caution

- **⚠ DANGER! NEVER** charge the battery pack in areas with extremely high temperatures, such as near fires or stoves, inside a sun-heated vehicle, or in direct sunlight. In such environments, the safety/protection circuit in the battery will activate, causing the battery to stop charging.
- **WARNING! DO NOT** charge or leave the battery in the battery charger beyond the specified time for charging. If the battery is not completely charged by the specified time, stop charging and remove the battery from the battery charger. Continuing to charge the battery beyond the specified time limit may cause a fire, overheating, or the battery may rupture.
- **WARNING! NEVER** insert the transceiver (battery attached to the transceiver) into the charger if it is wet or soiled. This could corrode the battery charger terminals or damage the charger. The charger is not waterproof.
- **CAUTION: DO NOT** charge the battery outside of the specified temperature range: 0°C to $+40^{\circ}\text{C}$ ($+32^{\circ}\text{F}$ to $+104^{\circ}\text{F}$). Icom recommends charging the battery at $+25^{\circ}\text{C}$ ($+77^{\circ}\text{F}$). The battery may heat up or rupture if charged out of the specified temperature range. Additionally, battery performance or battery life may be reduced.

4 BATTERY CHARGING

■ Regular charging

Prior to using the transceiver for the first time, the battery pack must be fully charged for optimum life and operation.

◇ Battery icon

When the transceiver's power is OFF, the charging icon sequentially shows "□", "▣", and "▤" along with "Charging..." while charging. The icon disappears when the battery pack is completely charged.

When the transceiver power is ON, the battery icon sequentially shows "□", "▣", "▤" and "▥" while charging, and the icon disappears when the battery pack is completely charged.

◇ Charging note

- Be sure to turn the transceiver power OFF. Otherwise the battery pack will not be charged completely or will take much longer to charge.
- External DC power is possible when using an optional CP-12L, CP-19R or OPC-254L. The attached battery pack is also charged simultaneously, except during transmit (see p. 18 for more details).
- The external DC power supply voltage must be between 10–16 V to charge the battery pack and when operating using an OPC-254L.

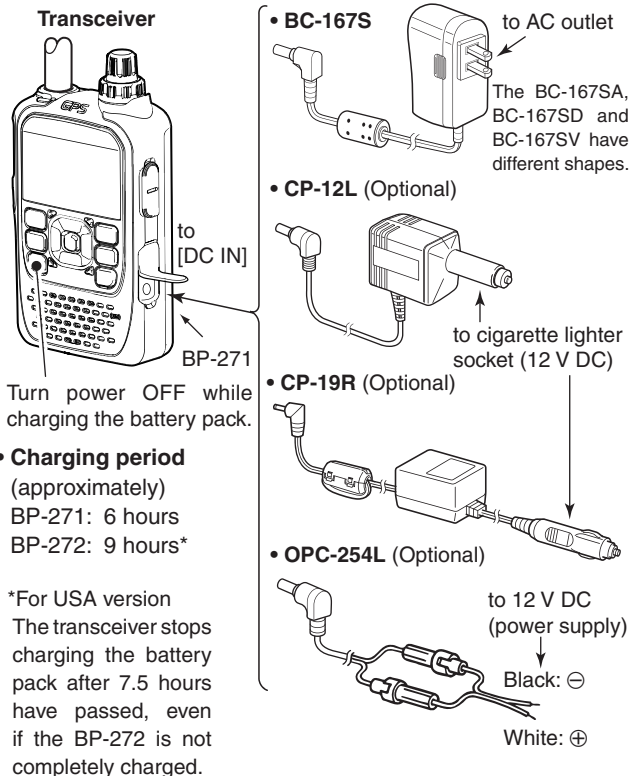

■ Rapid charging

The optional BC-202 rapidly charges of the BP-271 or BP-272 Li-ion battery packs.

◇ Charging note

- Be sure to turn OFF the transceiver power.
When the transceiver power cannot be turned OFF, detach the battery pack from the transceiver then charge the battery pack by itself, or charge the battery using regular charging. Otherwise the battery pack will not be charged (the charging indicator on the BC-202 blinks orange about 10 second after the battery pack is installed in BC-202).
- The BC-202 desktop charger can only charge BP-271 or BP-272 Li-ion battery packs. Other types of rechargeable battery, Ni-Cd or Ni-MH cannot be charged.
- If the charging indicator blinks orange, there may be a problem with the battery pack or charger. If this occurs, try charging the battery pack alone, without the transceiver, or try using the standard (non-rapid) charger. Contact your dealer if you have problems charging a new battery pack.
- **NEVER** place the transceiver with the battery pack to the desktop charger when the transceiver is connected to the DC power supply. This may cause the charger's malfunction and the charging indicator of the charger lights red. In that case, disconnect the AC adapter from the charger, and then reconnect the AC adapter to the charger.
- The optional CP-23L and OPC-515L can be used instead of the supplied AC adapter. Connect one of these to the [DC 12-16V] jack.

- **Charging period:** BP-271 approximately 2.0 hours
BP-272 approximately 3.5 hours

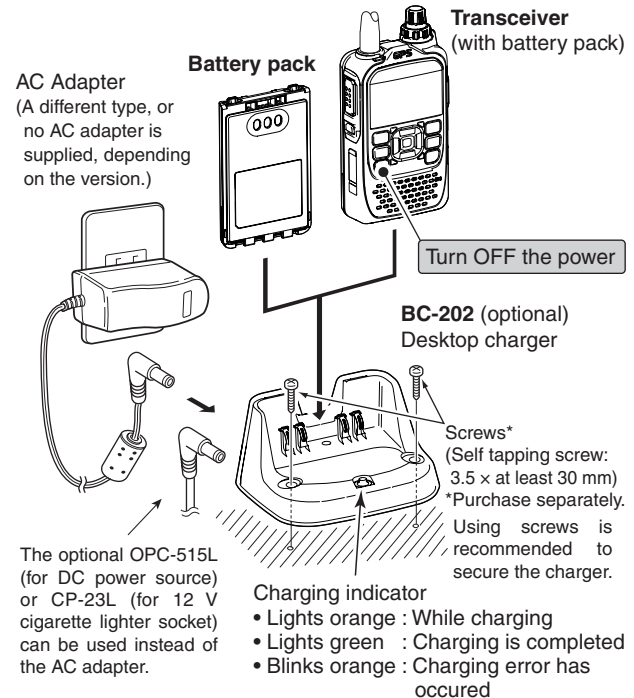

4 BATTERY CHARGING

■ Rapid charging (Continued)

/// **IMPORTANT: Battery charging caution**

/// Ensure the guide rails on the battery pack are correctly aligned with the tabs inside the charger.

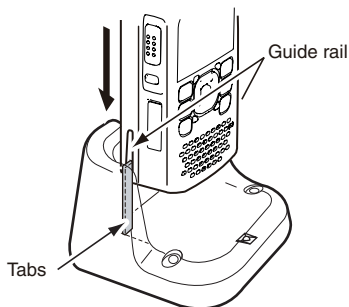

/// **CAUTION: When using the OPC-515L DC power cable**

/// **NEVER** connect the OPC-515L to a power source using reverse polarity. This will ruin the battery charger.

/// White line: ⊕ Black line: ⊖

NOTE: If the charging indicator blinks orange for 10 seconds or more with the battery pack installed in the transceiver, try charging the BP-271 alone. You can also try regular charging the BP-271 attached to the transceiver.

■ **Optional battery case**

When using the BP-273 BATTERY CASE, install 3 × AA (LR6) size alkaline batteries, as described below.

- ① Remove the battery case if it is attached. (p. 1)
- ② Install 3 × AA (LR6) size alkaline batteries.
 - Install only alkaline batteries.
 - Be sure to observe the correct polarity.
- ③ Attach the battery case. (p. 1)

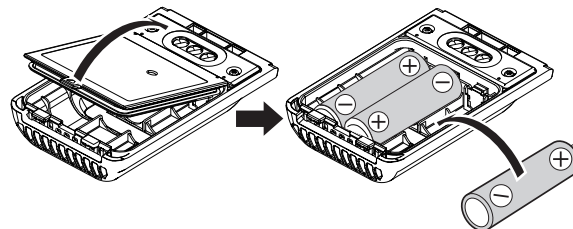

/// A built-in step-up converter in the BP-273 increases the voltage to 5.5 V DC.

/// Approximately 100 mW of output power is possible with the BP-273 operation. Also, the transmit output power selection is disabled.

/// The batteries may seem to have low capacity when used in low temperatures, such as -10°C ($+14^{\circ}\text{F}$) or below. Keep the batteries warm in this case.

CAUTION:

- When installing batteries, make sure they are all the same brand, type and capacity. Also, do not mix new and old batteries together.
- Keep the battery terminals clean. It's a good idea to periodically clean the battery terminals.
- Never incinerate used battery cells since the internal battery gas may cause them to rupture.
- Never expose a detached battery case to water. If the battery case gets wet, be sure to wipe it dry before using it.
- Never use batteries whose insulated covering is damaged.
- Remove the alkaline batteries when battery case is not used. Otherwise the installed alkaline batteries will be exhausted due to built-in step-up converter.

4 BATTERY CHARGING

■ Battery information

◇ Battery life

The transceiver operates with the BP-271 or BP-272 Li-ion battery packs, as follows.

When operating in the DV mode, the operating time may be shortened by one-half hour.

Battery pack	Voltage	Capacity	Battery life*1
BP-271	7.4 V	1150 mAh (min.) 1200 mAh (typ.)	4.5 hrs.
BP-272	7.4 V	1880 mAh (min.) 2000 mAh (typ.)	8 hrs.





*1 When the power save function is set to "Auto (Short)," and the operating time is calculated under the following conditions;
TX : RX : standby = 1 : 1 : 8

*2 The average operating life depends on the alkaline cells used.

◇ Battery icon

The " " battery icon appears when the BP-271 or BP-272 Li-ion battery pack is attached to the transceiver.

- When the BP-273 battery case is attached to the transceiver, the battery icon cannot display the battery capacity of the alkaline batteries. The battery icon stays "" , and it does not reflect with the true battery capacity.
- Without disconnecting the battery charger or external DC power, the battery icon does not appear when turning power ON after charging is completed.

Icon	Battery condition
	The battery has sufficient capacity.
	The battery is exhausted a little.
	The battery is nearing exhaustion. Charging is necessary. (The transceiver can be operated for a short time.)
	The battery is almost exhaustion. Charging is necessary. (The transceiver quickly becomes impossible to operate.)

External DC power operation

An optional CP-12L or CP-19R cigarette lighter cable, for a 12 V cigarette lighter socket, or an OPC-254L external DC power cable can be used for external power.

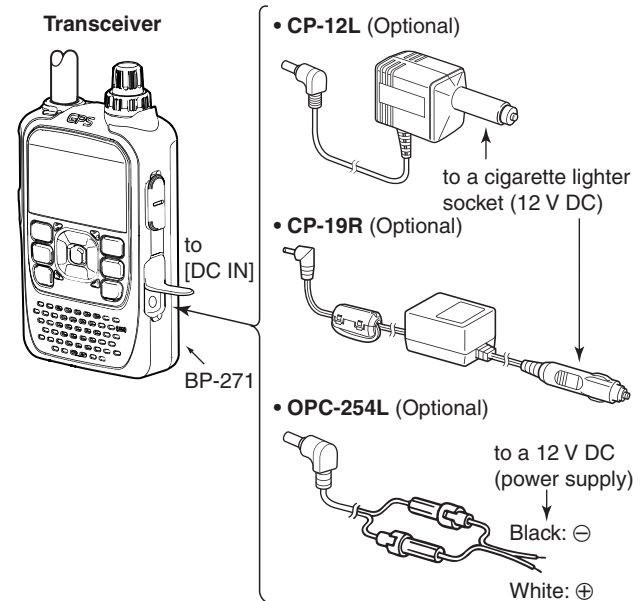

◇ Operating note

- The power supply voltage must be between **10.0–16.0 V DC**.
NEVER CONNECT OVER 16 V DC directly into the [DC IN] jack of the transceiver.
- **BE SURE** to use a **CP-12L**, **CP-19R** or **OPC-254L** when connecting a regulated 12 V DC power supply. Use an external DC-DC converter to connect the transceiver through an optional CP-12L, CP-19R or OPC-254L to a 24 V DC power source.
- The voltage of the external power supply must be between 10–16 V DC when using either CP-12L, CP-19R or OPC-254L, otherwise, use the battery pack.
- Disconnect the power cables from the transceiver when not using it. Otherwise, the vehicle battery will become exhausted.
- The power save function is automatically deactivated when using an external DC power source.



NOTE: Up to 5 W (approximately) of maximum output power is possible when using external DC power. However, when the supply voltage exceeds 14 V, the built-in protection circuit activates to reduce the transmit output power to approximately 2.5 W.

■ Power ON

- ➔ Hold down  for 1 second to turn ON power.
 - Hold down  for 1 second to turn OFF power.
 - After the opening message and power source voltage are displayed, the operating frequency appears.

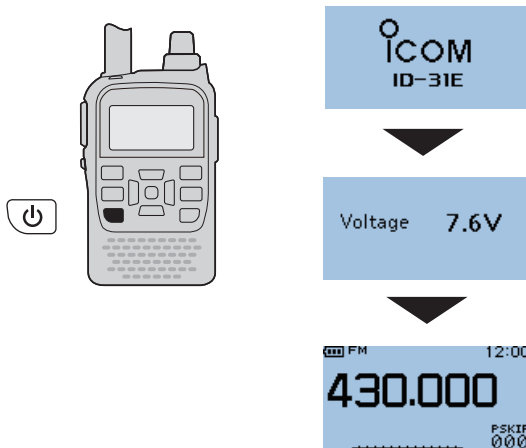

The opening message and power source voltage display options can be turned ON or OFF in the DISPLAY menu.

MENU ⇨ DISPLAY ⇨ **Opening Message** (p. 47)

MENU ⇨ DISPLAY ⇨ **Voltage Indication** (p. 47)

■ Setting audio volume

- ➔ Rotate [VOL] to adjust the audio level.
 - If the squelch is closed, hold down [SQL] while setting the audio level.
 - The display shows the volume level while adjusting.

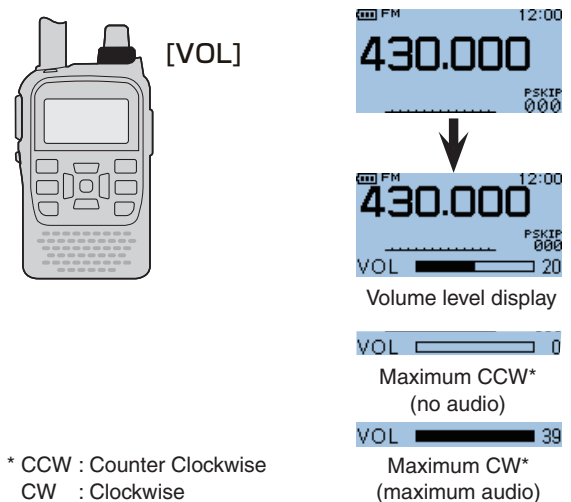

* CCW : Counter Clockwise
CW : Clockwise

The beep level is adjusted in the SOUNDS menu.

MENU ⇨ SOUNDS ⇨ **Beep Level** (p. 48)

■ Setting squelch level

The squelch function mutes the noise or received audio signal, depending on the signal strength and the squelch control setting to cut off the noise output.

- ➔ While holding down [SQL], rotate [DIAL] to select the squelch level.
 - While holding down [SQL], rotate [DIAL] one click to display the squelch level.
 - “LEVEL1” is loose squelch (for weak signals) and “LEVEL9” is tight squelch (for strong signals).
 - “AUTO” indicates automatic level adjustment by a noise pulse counting system.
 - “OPEN” indicates a continuously open setting. (This option is not selectable in the DV mode.)

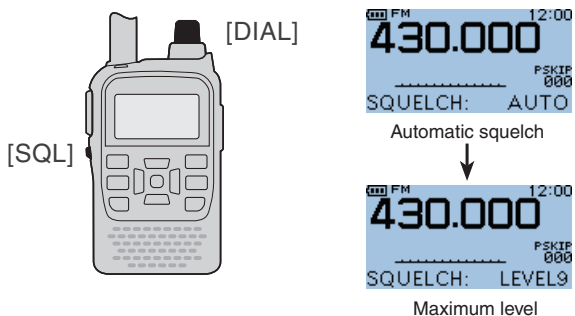

■ Monitor function

This function is used to listen to weak signals without disturbing the squelch setting, or having to open the squelch manually even when mute functions such as the tone squelch are in use.

- ➔ Hold down [SQL] to monitor the operating frequency.
 - The 1st segment of the S-meter blinks.

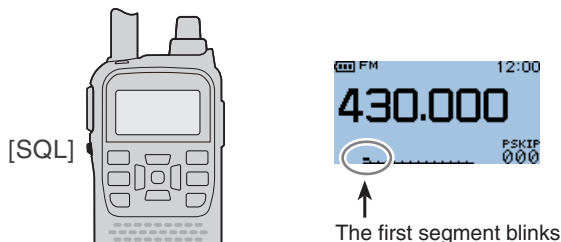

▨ The [SQL] key can be set to ‘sticky’ operation in FUNCTION menu.

MENU ⇄ FUNCTION ⇄ **Monitor** (p. 44)

5 BASIC OPERATION

■ Mode selection

◇ VFO mode

The VFO mode is used to set the desired frequency.

➡ Push [V/MHz]  to select the VFO mode.



• VFO mode display





What is a VFO?

VFO is an abbreviation of Variable Frequency Oscillator. Frequencies for both transmitting and receiving are generated and controlled by the VFO.

◇ Memory mode

Memory mode is used for operation on memory channels, which store programmed frequencies.

① Push [M/CALL]  once or twice to select the memory mode.

- “**MR**” appears when the memory mode is selected.
- Push [M/CALL]  again to select Call channels. The Memory mode or Call channels are alternately selected.

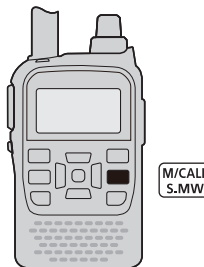

• Memory mode display





Appears

- ② Rotate [DIAL] to select a desired memory channel.
- Only programmed memory channels can be selected.
 - See p. 28 for memory programming details.

◇ Call channels

Call channels are used for quick recall of most-often used frequencies.

- ① Push [M/CALL]  once or twice to select the call channels.
 - Push [M/CALL]  again to select the Memory mode. The Memory mode or Call channels are alternately selected.



• Call channel display



- ② Rotate [DIAL] to select a desired Call channel.

◇ DR (D-STAR Repeater) mode

The DR (D-STAR Repeater) mode is used for D-STAR repeater operation. In this mode, you can easily select the pre-programmed repeaters and UR call signs by rotating [DIAL].

D-STAR is an abbreviation for Digital Smart Technologies for Amateur Radio.

- ① Hold down  for 1 seconds to select the DR mode.



• DR mode display

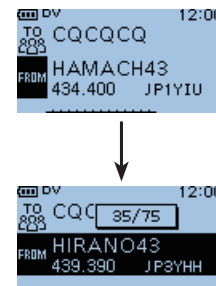



- ② Rotate [DIAL] to select a desired access repeater.

■ Setting a tuning step

The following tuning steps are selectable.

- 5.0 kHz • 6.25 kHz • 10.0 kHz • 12.5 kHz
- 15.0 kHz • 20.0 kHz • 25.0 kHz • 30.0 kHz
- 50.0 kHz • 100.0 kHz • 125.0 kHz • 200.0 kHz

◇ Tuning step selection

- ① Push [V/MHz]  to select VFO mode, if necessary.
- ② Push  to open the Quick Menu screen.
- ③ Push D-pad(↑) to select “TS,” and then push D-pad(Ent).

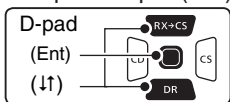



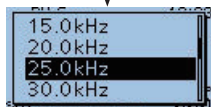
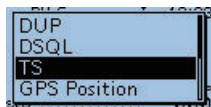
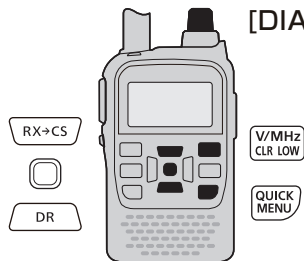

- ④ Rotate [DIAL] to select the desired tuning step.
- ⑤ Push D-pad(Ent) to save the setting and exit the Quick Menu screen.



25 kHz tuning step



■ Setting a frequency

- ① Push [V/MHz]  to select VFO mode, if necessary.
- ② Rotate [DIAL] to select the desired frequency.
 - The frequency changes according to the selected tuning steps. See the previous content to set the tuning step.
 - When VFO mode is selected, push [V/MHz]  then rotate [DIAL] to change the frequency in 1 MHz steps. Or push [V/MHz]  again for 10 MHz* steps. (* Depending on versions, 10 MHz tuning step is selectable.) Push [V/MHz]  again to cancel it.



The frequency changes according to the selected tuning step.



After pushing [V/MHz] in the VFO mode, [DIAL] changes the frequency in 1 MHz or 10 MHz steps.

■ Operating mode selection

Operating modes are determined by the modulation of the radio signals. The transceiver has a total of three operating modes; FM, FM-N and DV.

- ➔ Push [FM/DV]  one or more times to select a desired operating mode.

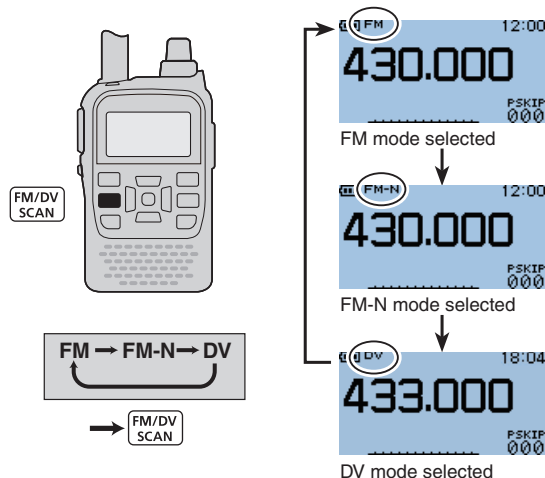

■ Receiving

Make sure a charged BP-271 or BP-272 battery pack, or a BP-273 battery case with brand new alkaline batteries is attached (pp. 1, 14).

- ① Hold down  for 1 second to turn ON the power.
- ② Rotate [VOL] to adjust to a desired audio level. (p. 19)
 - The frequency display shows the volume level while adjusting.
- ③ Set the receiving frequency. (p. 23)
- ④ Set the squelch level. (p. 20)
 - While holding down [SQL], rotate [DIAL] one click to display the squelch level.
 - “LEVEL1” is loose squelch (for weak signals) and “LEVEL9” is tight squelch (for strong signals).
 - “AUTO” indicates automatic level adjustment by a noise pulse counting system.
 - Hold down [SQL] to manually open the squelch.
- ⑤ When a signal is received:
 - Squelch opens and audio is output.
 - TX/RX indicator lights green.
 - The S/RF-meter shows the relative signal strength level.

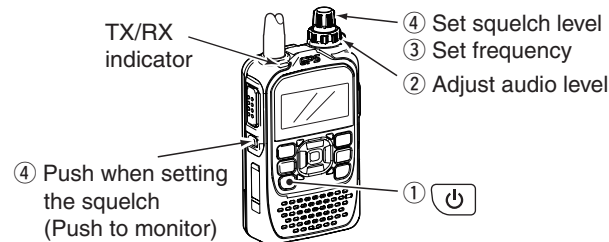

■ Transmitting

CAUTION: Transmitting without an antenna will damage the transceiver.

NOTE: To prevent interfering, hold down [SQL] to listen on the channel before transmitting.

- ① Set the operating frequency.
(p. 23)
 - Transmitting can be done only on the 430 MHz amateur band.
 - Select the output power if desired. See the next page for details.
- ② Hold down [PTT] to transmit.
 - The TX/RX indicator lights red.
 - The S/RF meter shows the output power level.
- ③ Speak into the microphone using your normal voice level.
 - DO NOT hold the transceiver too close to your mouth or speak too loudly. This may distort your speech.
- ④ Release [PTT] to receive.

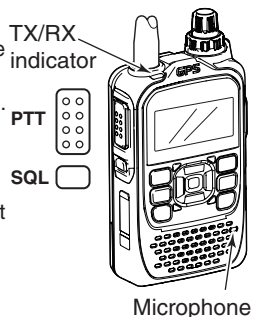

⚠ WARNING! NEVER transmit for long periods of time. During prolonged transmissions at high power or middle power, the transceiver radiates heat to protect itself from overheating. The transceiver's chassis will become hot and may cause a burn.

- To prevent the transceiver's overheating, the default setting of the time-out timer function is set to 5 minutes (p. 44). Be careful when the time-out timer function is turned OFF or set to a long time period, and you transmit for long periods.

DO NOT operate the transceiver in a situation that will obstruct heat dissipation, especially if the transceiver uses an external power supply. Heat dissipation may be affected, and it may cause a burn, warp the casing or damage the transceiver.

NOTE: When the transceiver becomes hot, the transceiver's heat protection function gradually reduces the output power to approximately 2.5 watts, then it stops transmission after that. This is done to protect the transceiver itself until it can cool down.

CONNECT to only the rated voltage range when using an external power supply.

■ Transmit power selection

The transceiver has four output power levels to suit your operating requirements. Lower output power during short-range communications may reduce the possibility of interference to other stations and will conserve battery power.

- ➔ Hold down [LOW] $\left[\frac{V}{MHz} \right]$ for 1 second to toggle the transmit approximately output power between High (5 W), S-Low (0.1 W), Low (0.5 W) and Mid (2.5 W).
 - Or while holding down [LOW] $\left[\frac{V}{MHz} \right]$, rotate [DIAL] to select the output power.

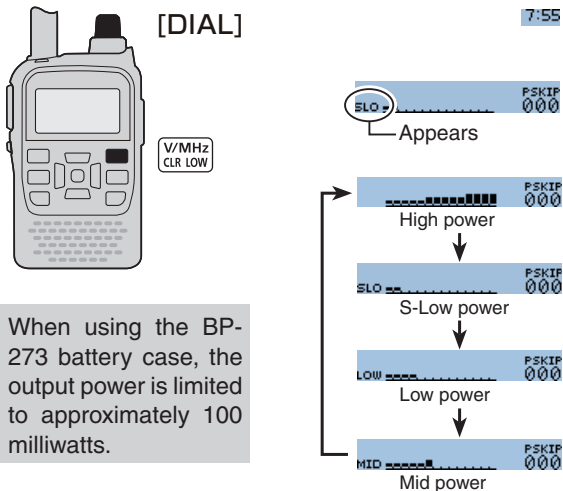

When using the BP-273 battery case, the output power is limited to approximately 100 milliwatts.

■ Key Lock function

Activate to prevent accidental frequency changes and unnecessary function access.

- ➔ Hold down [LOCK] $\left[\frac{MENU}{\text{LOCK}} \right]$ for 1 second to turn the Key Lock function ON or OFF.
 - While the Key Lock function is activated and the locked key or dial is pushed or rotated, "LOCK ON" will be displayed.
 - $\left[\text{POWER} \right]$, [VOL], [SQL], [PTT] and [LOCK] $\left[\frac{MENU}{\text{LOCK}} \right]$ are operable while the lock function is activated.
 - Either or both the squelch control and volume control can also be locked in the Function menu.

MENU \leftrightarrow FUNCTION \leftrightarrow **Key Lock** (p. 44)

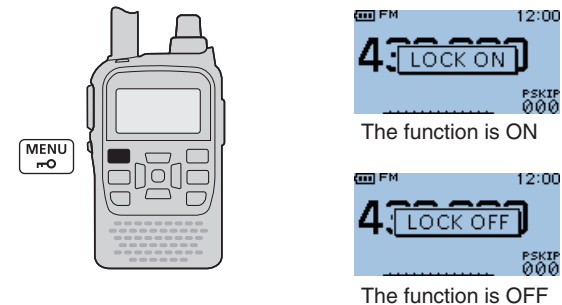



5 BASIC OPERATION

■ Scan function

Scanning is a versatile function that can automatically search for signals, and makes it easier to locate stations to contact or listen to, or to skip unwanted frequencies.

[Example]: Full scan operation in the VFO mode

- ① Push [V/MHz]  to select the VFO mode.
- ② Set the squelch level.
- ③ Hold down [SCAN]  for 1 second to enter the scanning type selection mode.
- ④ Push D-pad(↓) to select the desired scanning type.

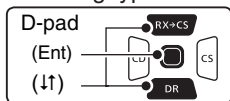

- Select "ALL" for full scan, "P-LINKx" for programmed link scan (x= 0 to 9), "Pxx" for programmed scan (xx= 0 to 24; only programmed scan edge numbers are displayed), "DUP" for duplex scan or "TONE" for tone scan.
- ⑤ Push D-pad(Ent) to start the scan.
 - Scan pauses when a signal is received.
 - Rotate [DIAL] to change the scanning direction. This also causes the transceiver to resume scanning.
 - Push [CLR]  to cancel the scan.

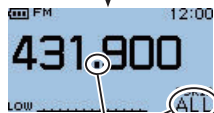
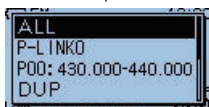

/// **About the scanning steps:** The selected tuning step in the VFO mode is used during scan.

- /// • The scan link name or scan name can be displayed when scan link name or scan name is programmed.
- /// • Scan name is not displayed during scan.

Memory channel programming

The Memory mode is very useful to quickly select often-used operating settings.

[Example]: Programming 433.600 MHz/FM mode into memory channel 11 (a blank channel).

- ① Push [V/MHz]  to select the VFO mode.



- ② Set a desired frequency and operating mode:

- ➔ Rotate [DIAL] to set a desired frequency.
- ➔ Push [FM/DV]  one or more times to select a desired operating mode.
- ➔ Set other data (e.g. duplex direction, frequency offset, tone squelch, etc.), if desired.

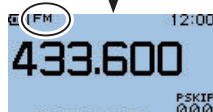

- ③ Hold down [S.MW]  for 1 second to enter the Select Memory write mode.

- 1 short and 1 long beep sound.
- The memory channel number blinks.

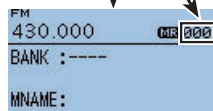

Select Memory write mode



- ④ Rotate [DIAL] to select a desired channel.

- Call channels (C0, C1), VFO and scan edge channels (00A/00B to 24A/24B), as well as regular memory channels, can be programmed in this way.

- ⑤ Hold down [S.MW]  for 1 second to program.

- 3 beeps sound.
- Before returning to the VFO mode, the programmed memory contents are displayed for a moment.
- Memory channel number automatically increases when continuing to hold down [S.MW]  for 1 second after programming.

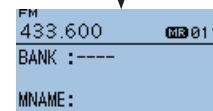
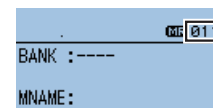

Memory contents is displayed for a moment

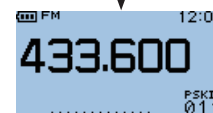

After programming is finished, return to the VFO mode

NOTE: Push [CLR]  to cancel the program and exit the Select Memory write mode before memory programming is finished.

5 BASIC OPERATION

■ Repeater operation

When using a repeater, the transmit frequency is shifted from the receive frequency by the frequency offset (p. 33). This is called duplex operation. It is convenient to program repeater information into memory channels (p. 28).

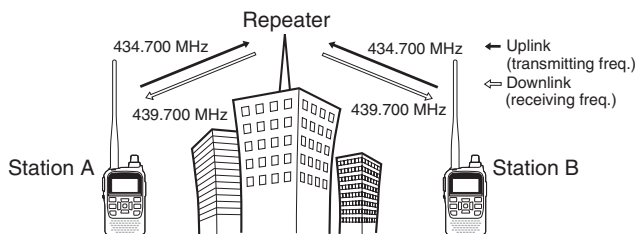

- ① Set the receive frequency (repeater output frequency).
- ② Set the shift direction of the transmit frequency in the Quick Menu (DUP- or DUP+; see next page for details).
 - When the Auto Repeater function is in use (only U.S.A., Canada and Korean versions), this selection and step ③ are not necessary. (p. 44)

“DUP-” or “DUP+” appears



- ③ If desired, activate the subaudible tone encoder in the Quick Menu (see next page for details).

“TONE” appears

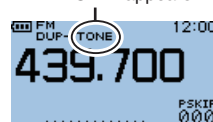

- ④ Hold down [PTT] to transmit.
 - The displayed frequency automatically changes to the transmit frequency (repeater input frequency).
 - If “OFF BAND” appears, check the frequency offset and shift direction. (p. 33)

While receiving

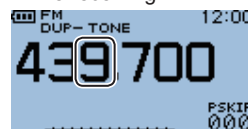

While transmitting

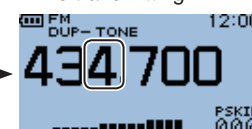

- ⑤ Release [PTT] to receive.
- ⑥ Hold down [SQL] to check whether the other station's transmit signal can be directly received or not.
 - When the other station's signal can be directly received, move to a non-repeater frequency to use simplex (duplex OFF).

/// U.S.A., Canada and Korean versions:

Auto repeater function uses standard values of the repeater tone frequency and offset frequency.

◇ **Setting the duplex direction**

① In the VFO mode, push **QUICK MENU** to open the Quick Menu screen.



② Push D-pad(↑) to select the “DUP” item, then push D-pad(Ent).

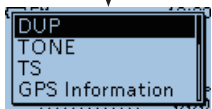
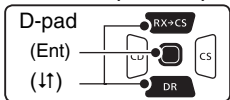

③ Push D-pad(↓) to select the “DUP-” or “DUP+” option.

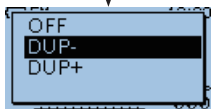

④ Push D-pad(Ent) to return to the frequency display.

- Select the desired frequency offset. (p. 33)

“DUP-” or “DUP+” appears

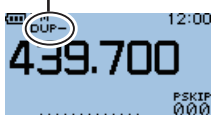

◇ **Setting the subaudible tone**

① In the VFO mode, push **QUICK MENU** to open the Quick Menu screen.

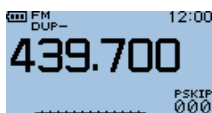

② Push D-pad(↑) to select the “TONE” item, then push D-pad(Ent).

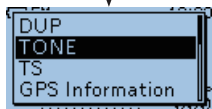
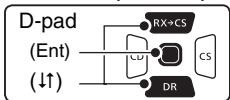

③ Push D-pad(↓) to select the “TONE” option.

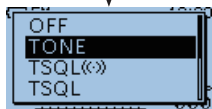

④ Push D-pad(Ent) to return to the frequency display.

- Select the desired subaudible tone frequency. (p. 33)

“TONE” appears

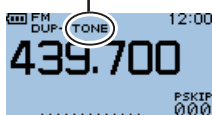

■ Band Scope function

The Band Scope function allows you to visually check a specified frequency range around the center frequency.

▨ The receive audio during sweeping can be muted in SOUNDS menu. See page 48 for details.

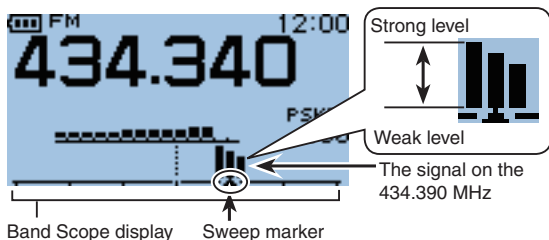

▨ About the sweep steps:

▨ The specified tuning step (in VFO mode) or programmed tuning step (in memory mode) is used during sweep.

▨ If the tuning step is set to wide, the present signal may not be displayed (may be skipped), even that is strong signal.

▨ Thus we recommend to set the tuning step to the 20 kHz or less to use the Band Scope function.

▨ See page 23 for the Tuning step selection details.

◇ Sweep operation

① Push **QUICK MENU** to open the Quick Menu screen.

② Push D-pad(↓) to select “Band Scope,” and then push D-pad(Ent).

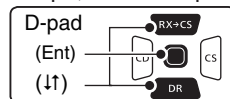

③ Push D-pad(↓) to select the “Single Sweep” or “Continuous Sweep” option.

④ Push D-pad(Ent) to return to the frequency display and start sweeping.

- Single Sweep check the specified frequency range at once.
- Continuous Sweep continuously checks the specified frequency range.
- Push D-pad(Ent) to stop sweeping and push again to restart it.
- While stop sweeping, rotate [DIAL] to move the sweep marker to a detected signal, you can hear the signal audio.
- While stop sweeping, push [CLR] $\frac{V}{MHz}$ CLR LOW to cancel the Band Scope function.

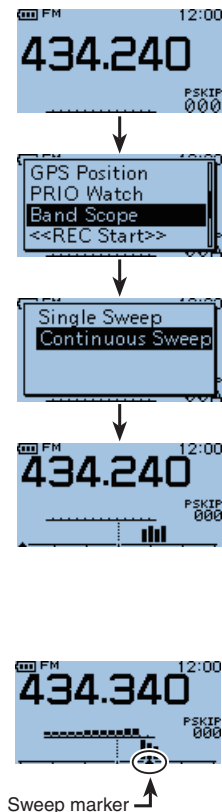

■ Menu item selection

The MENU screen is used for programming infrequently changed values or function settings.

In addition to this page, see pages 33 through 49 for details of each item's options and their default value.

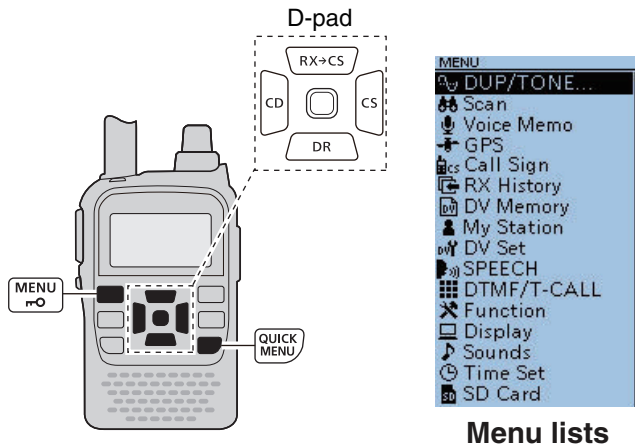

NOTE: The Menu screen is constructed in a zoomed structure. To go to the next level; “zoom in,” and to go back a level; “zoom out.”



Menu lists

◇ Entering the Menu screen and operation

Example: Set the Auto Power OFF function to “30 min.”

- ① Push [MENU] .
- ② Push D-pad(↑) to select the root item (Time Set), and then push D-pad(Ent).
 - If D-pad(↑) is continuously held down, the items are sequentially highlighted.
- ③ Push D-pad(↑) to select “Auto Power OFF,” and then push D-pad(Ent).
- ④ Push D-pad(↑) to select “30 min.”
- ⑤ Push [MENU]  to exit the Menu screen.

To return to the default setting, push  in step ④ to display “Default,” and then push D-pad(Ent).

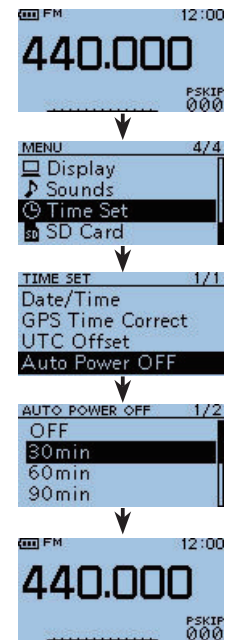

■ Menu items and default settings

/// **NOTE:** The default settings, shown below, are for the USA version.

/// The default settings may differ, depending on the version.

DUP/TONE...	In this item, set the repeater options, for example duplex offset or the channel tone types.	
	RANGE OR VALUE (Default is shown in bold)	DESCRIPTIONS
Offset Freq	0.000~ 5.000.00 ~59.995	Sets the frequency offset for duplex (repeater) operation.
Repeater Tone	67.0~ 88.5 ~254.1	Selects the tone frequency used to access the repeaters.
TSQL Freq	67.0~ 88.5 ~254.1	Selects the tone frequency for the Tone squelch or the pocket beep function.
Tone Burst	OFF or ON	Turns the Tone Burst function ON or OFF. When this setting is ON and you transmit a signal which superimposes the CTCSS tone or subaudible tone, the squelch tail noise of FM mode is suppressed on the RX side.
DTCS Code	023 ~754	Selects DTCS (both encoder/decoder) code for DTCS squelch or the pocket beep function.
DTCS Polarity	Both N , TN-RR, TR-RN or Both R	Selects the DTCS polarity for the DTCS squelch or the pocket beep function.
Digital Code	00 ~99	Selects the digital code for the Digital Code squelch function.

/// **NOTE:** The default settings, shown below, are for the USA version.
 /// The default settings may differ, depending on the version.

Scan		In this item, set the scan options.	
		RANGE OR VALUE (Default is shown in bold)	DESCRIPTIONS
Pause Timer		2sec~ 10sec ~20sec or HOLD	Selects the scan pause time. When receiving signals, the scan pauses according to the scan pause timer.
Resume Timer		0sec~ 2sec ~5sec or HOLD	Selects the scan resume time from a pause after the received signal disappears.
Program Skip		OFF or ON	Turns the Program Skip Scan function ON or OFF for a VFO mode scan.
Bank Link		A: <input checked="" type="checkbox"/> ~Z: <input checked="" type="checkbox"/>	Selects banks to be scanned during a Bank Link Scan.
Program Link* ¹			Selects program scans to be scanned during a the Program Link Scan.

*¹ See the PDF type Advanced Instruction for details on the preset values.

6 MENU SCREEN OPERATION

■ Menu items and default settings (Continued)

/// **NOTE:** The default settings, shown below, are for the USA version.
 /// The default settings may differ, depending on the version.

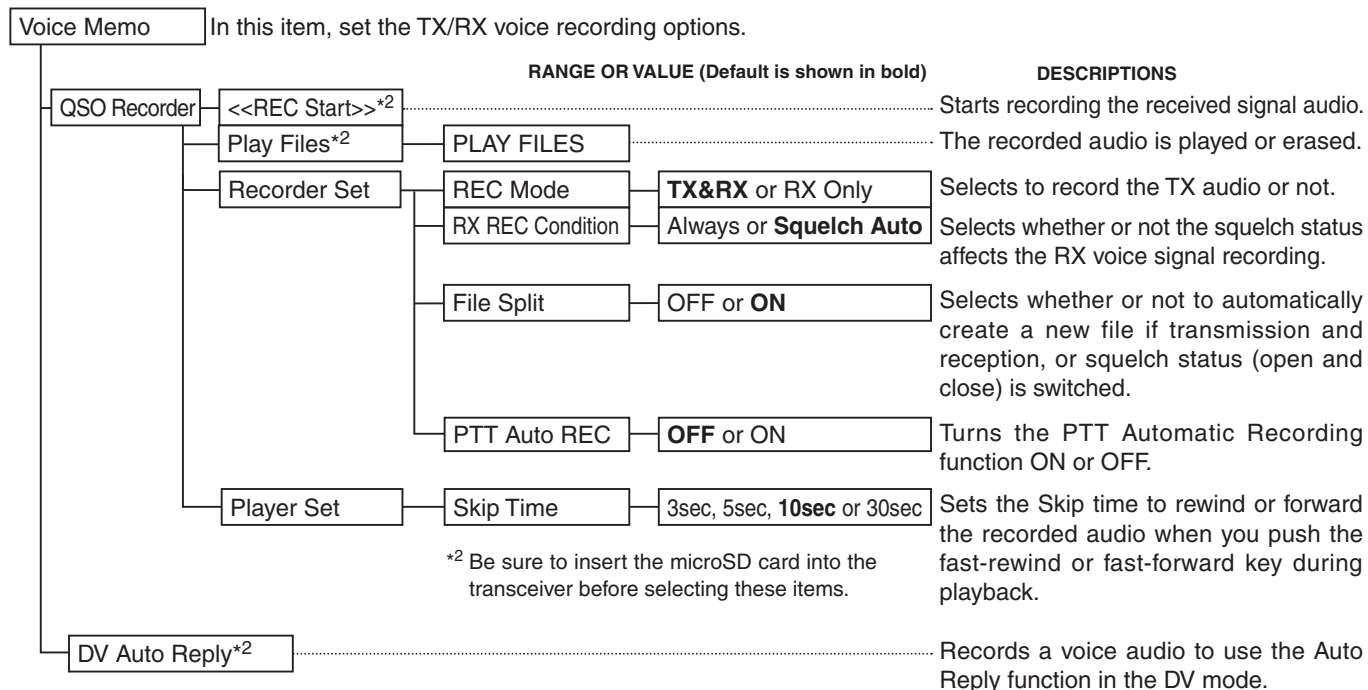

/// **NOTE:** The default settings, shown below, are for the USA version.
 /// The default settings may differ, depending on the version.

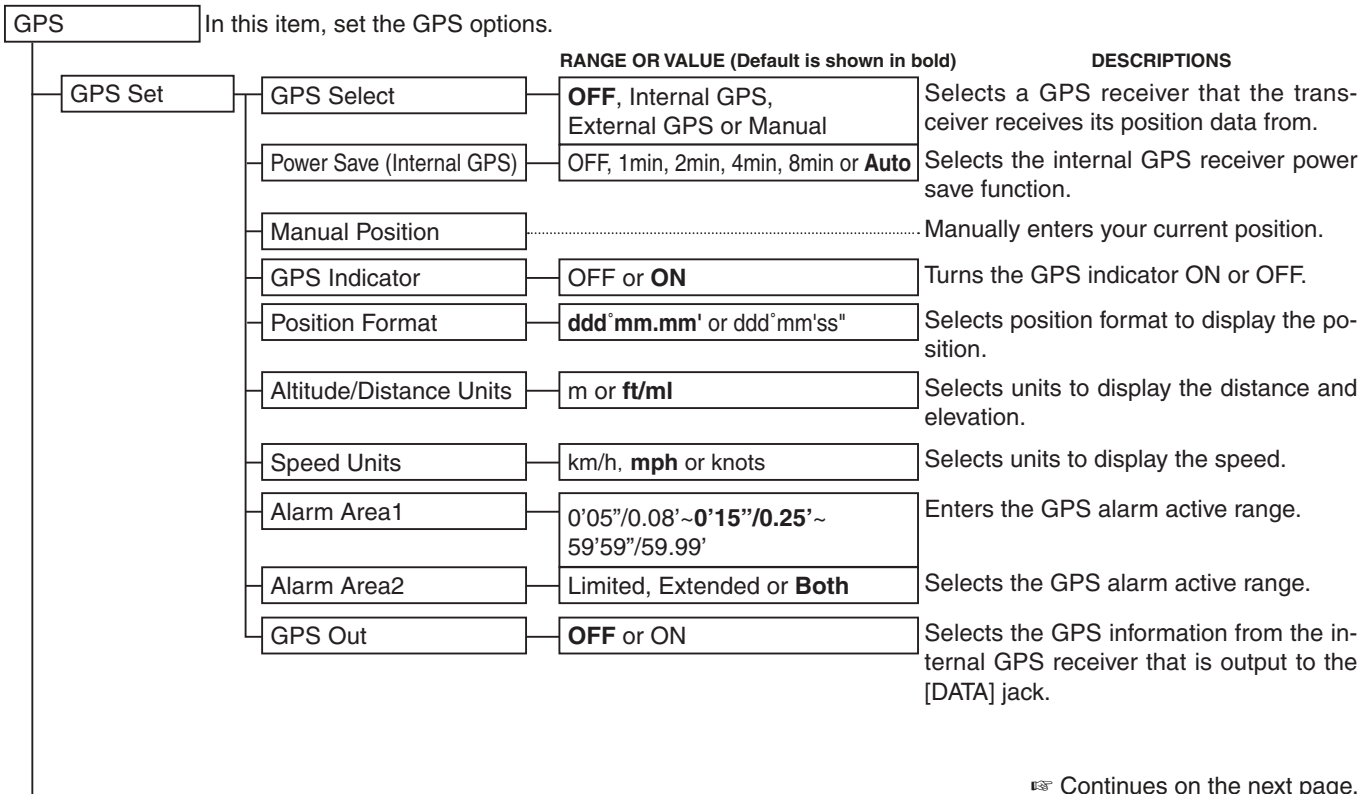

⌂ Continues on the next page.

6 MENU SCREEN OPERATION

■ Menu items and default settings (Continued)

/// **NOTE:** The default settings, shown below, are for the USA version.
 /// The default settings may differ, depending on the version.

GPS (Continued)		In this item, set the GPS options.	
	RANGE OR VALUE (Default is shown in bold)		DESCRIPTIONS
GPS Information			Displays the received GPS information.
GPS Position			Displays your position or other station's positions.
GPS Memory			Displays memorized positions, or turns the GPS alarm function ON or OFF.
GPS Logger*2	GPS Logger	OFF or ON	Turns the GPS logger function ON or OFF, to store your route as you move.
	Record Interval	1sec , 5sec, 10sec, 30sec or 60sec	Selects the GPS Logger function record interval.
	<<GPS Logger Only>>		Turns ON the GPS logger function with the transceiver in the Sleep mode.
		*2 Be sure to insert the microSD card into the transceiver before selecting these items.	
GPS TX Mode			Selects an operating mode to transmit position data received from a GPS receiver.
OFF			Turns OFF the GPS TX function.
GPS(DV-G)	GPS Sentence	RMC, GGA , GLL, VTG, GSA or GSV	Transmits position data in selected GPS sentences.
	GPS Message		Enter a GPS message of the GPS TX function.

/// **NOTE:** The default settings, shown below, are for the USA version.
 /// The default settings may differ, depending on the version.

GPS (Continued) In this item, set the GPS options.

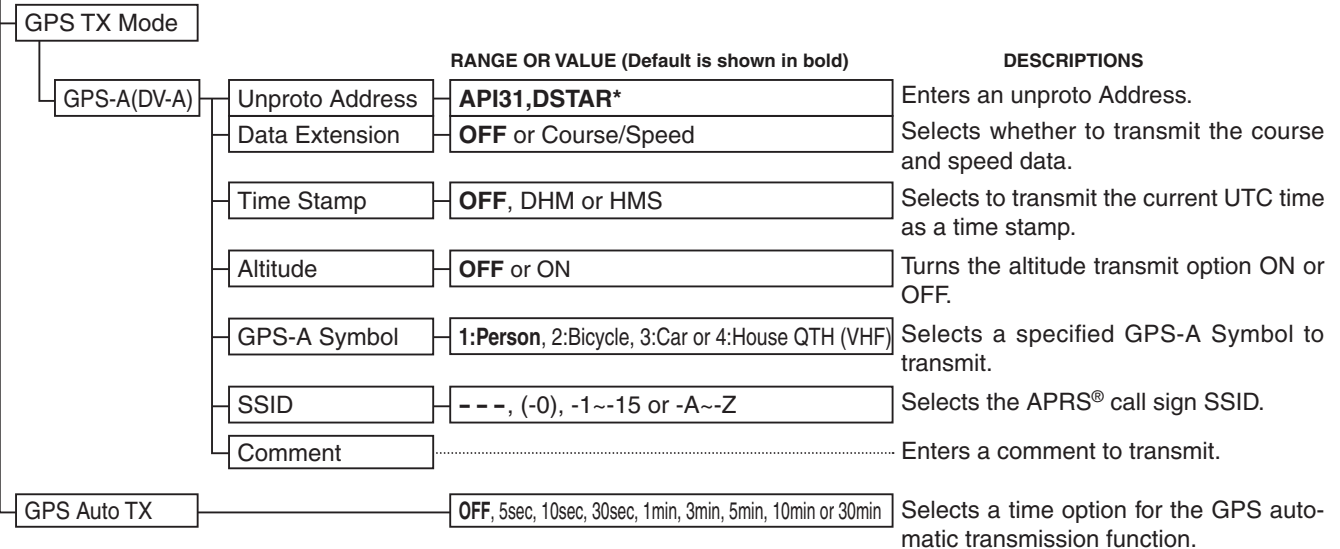

⌂ Continues on the next page.

6 MENU SCREEN OPERATION

■ Menu items and default settings (Continued)

/// **NOTE:** The default settings, shown below, are for the USA version.
/// The default settings may differ, depending on the version.

		DESCRIPTIONS	
Call Sign	In this item, set and display the call signs used in the DV mode.		
	UR: CQCQCQ, R1: -----, R2: -----, MY: -----	Displays the operating call signs. Sets the operating call signs on other than the DR mode.	
RX History	In this item, display the received call history.		
	None	Displays the Received Call record.	
DV Memory	In this item, enter and edit Your Call sign or repeater information to use in the DV and DR modes.		
	Your Call Sign	None	Stores station call signs.
	Repeater List* ¹	01:~20:	Stores repeater information.

/// **NOTE:** The repeater list described on this manual may differ from your presetting.

*¹ See the PDF type Advanced Instruction for details on the preset values.

/// **NOTE:** The default settings, shown below, are for the USA version.
 /// The default settings may differ, depending on the version.

My Station In this item, set your own call sign to use in the DV mode.

	RANGE OR VALUE (Default is shown in bold)	DESCRIPTIONS
My Call Sign	1:~6:	Stores and selects Your own call signs.
TX Message	1:~5: or OFF	Stores and selects TX Messages.

DV Set In this item, set infrequently changed values or functions in the DV mode.

	RANGE OR VALUE (Default is shown in bold)	DESCRIPTIONS	
Tone Control	RX Bass	Cut, Normal or Boost	Sets the DV mode received audio bass filter level to Cut, Normal or Boost.
	RX Treble	Cut, Normal or Boost	Sets the DV mode received audio treble filter level to Cut, Normal or Boost.
	RX Bass Boost	OFF or ON	Turns the DV mode received audio Bass Boost function ON or OFF
	TX Bass	Cut, Normal or Boost	Sets the DV mode transmit audio bass filter level to Cut, Normal or Boost.
	TX Treble	Cut, Normal or Boost	Sets the DV mode transmit audio treble filter level to Cut, Normal or Boost.

☞ Continued on the next page.

6 MENU SCREEN OPERATION

■ Menu items and default settings (Continued)

/// **NOTE:** The default settings, shown below, are for the USA version.
/// The default settings may differ, depending on the version.

DV Set (Continued)

In this item, set infrequently changed values or functions in the DV mode.

	RANGE OR VALUE (Default is shown in bold)	DESCRIPTIONS
Auto Reply	OFF , ON or Voice	Selects the Automatic Reply function ON, OFF or Voice.
DV Data TX	PTT or Auto	Selects manually or automatically to transmit low speed data.
Digital Monitor	Auto , Digital or Analog	Selects the DV mode RX monitoring when [SQL] is held down.
Digital Repeater Set	OFF or ON	Turns the digital repeater setting function ON or OFF.
RX Call Sign Write	OFF or Auto	Turns the RX call sign automatic write function ON or OFF.
RX Repeater Write	OFF or Auto	Turns the repeater call sign automatic write function ON or OFF.
DV Auto Detect	OFF or ON	Turns the DV mode automatic detect function ON or OFF.
RX Record (RPT)	ALL or Latest Only	The transceiver can record the data of up to 40 individual calls. When you receive a call that the destination station did not reply to, or one in which the link repeater was not found, you can record all of them or only the latest one, in the Received Call Record.

/// **NOTE:** The default settings, shown below, are for the USA version.
 /// The default settings may differ, depending on the version.

DV Set (Continued) In this item, set infrequently changed values or functions in the DV mode.

	RANGE OR VALUE (Default is shown in bold)	DESCRIPTIONS
BK	OFF or ON	Turns the BK (Break-in) function ON or OFF. The BK function allows you to break into a conversation where the two original stations are communicating with call sign squelch enabled.
EMR	OFF or ON	Turns the EMR (Enhanced Monitor Receive) communication mode ON or OFF. The EMR mode can be used in the DV mode and no call sign setting is necessary. When an EMR mode signal is received, the audio (voice) will be heard at the specified level even the volume setting level is set to minimum level, or digital call sign/digital code squelch is turned ON.
EMR AF Level	0~ 19 ~39	Sets the audio output level when an EMR mode signal is received.

☞ Continued on the next page.

6 MENU SCREEN OPERATION

■ Menu items and default settings (Continued)

/// **NOTE:** The default settings, shown below, are for the USA version.
/// The default settings may differ, depending on the version.

SPEECH		In this item, set the Speech functions.	
	RANGE OR VALUE (Default is shown in bold)		DESCRIPTIONS
RX Call Sign SPEECH	OFF, ON (Kerchunk) or ON (All)		Selects the RX call sign speech function option while ON or turns it OFF.
RX>CS SPEECH	OFF or ON		Turns the RX>CS Speech function ON or OFF.
SPEECH Language	English or Japanese		Selects either English or Japanese as the desired speech language.
Alphabet	Normal or Phonetic Code		Selects the alphabet character announcement type.
SPEECH Speed	Slow or Fast		Selects Slow or Fast speech speed
SPEECH Level	0~ 7 ~9		Sets a volume level for the voice synthesizer.

DTMF/T-CALL		In this item, set the DTMF Memory functions.	
DTMF Memory	T-CALL, d0 :~d9:, dA:~dD:, d*: or d#:		Selects a DTMF memory channel to transmit.
DTMF Speed	100ms , 200ms, 300ms or 500ms		Selects the DTMF transfer speed.

/// **NOTE:** The default settings, shown below, are for the USA version.
 /// The default settings may differ, depending on the version.

Function	In this item, set other options.	RANGE OR VALUE (Default is shown in bold)	DESCRIPTIONS
Power Save		OFF, Auto (Short) , Auto (Middle) or Auto (Long)	Selects the Power Save options to reduce current drain and conserve battery power.
Monitor		Push or Hold	Selects the [SQL] monitor function method.
Dial Speed-UP		OFF or ON	Turns the dial speed acceleration ON or OFF.
Auto Repeater		OFF or ON (DUP) , ON (DUP,TONE)	Turns the Auto Repeater function ON or OFF.
MIC Simple Mode		Simple, Normal-1 or Normal-2	Selects the Microphone simple mode options.
Key Lock		Normal , No SQL, No VOL or ALL	Selects the key lock type when the Key Lock function is turned ON.
PTT Lock		OFF or ON	Turns the PTT Lock function ON or OFF.
Busy Lockout		OFF or ON	Turns the Busy Lockout function ON or OFF.
Time-Out Timer		OFF, 1min, 3min, 5min , 10min, 15min or 30min	Selects the Time-Out Timer time options.

☞ Continued on the next page.

6 MENU SCREEN OPERATION

■ Menu items and default settings (Continued)

/// **NOTE:** The default settings, shown below, are for the USA version.
 /// The default settings may differ, depending on the version.

Function (Continued)		In this item, set other options.	
		RANGE OR VALUE (Default is shown in bold)	DESCRIPTIONS
MIC Gain (Internal)		1~ 3 ~4	Sets the internal microphone sensitivity to suit your preference.
MIC Gain (External)		1~ 2 ~4	Sets the external microphone sensitivity to suit your preference.
Data Speed		4800bps or 9600bps	Selects the data transmission speed for low-speed communication, or between the [DATA] jack and external modules like a GPS receiver, and so on.
VOX	VOX	OFF or ON	Turns the VOX function ON or OFF.
	VOX Level	1~ 5 ~10 or OFF	Sets the VOX gain level.
	VOX Delay	0.5sec , 1.0sec, 1.5sec, 2.0sec, 2.5sec or 3.0sec	Sets the VOX Delay time.
	VOX Time-Out Timer	OFF, 1min, 2min, 3min , 4min, 5min, 10min or 15min	Sets the VOX Time-Out Timer to prevent an accidental prolonged transmission.
	Headset Select	HS-95 or Other	Selects the headset type to be used for the VOX function to limit the maximum audio output level to protect the headset speaker.

/// **NOTE:** The default settings, shown below, are for the USA version.
 /// The default settings may differ, depending on the version.

Function (Continued) In this item, set other options.

	RANGE OR VALUE (Default is shown in bold)	DESCRIPTIONS	
CI-V	CI-V Address	01~ 84 ~DF	Sets the transceiver's unique CI-V hexadecimal address code.
	CI-V Baud Rate	300, 1200, 4800, 9600, 19200 or Auto	Sets the CI-V code transfer speed.
	CI-V Transceive	OFF or ON	Turns the CI-V Transceive function ON or OFF.

Display In this item, set the Display options.

	RANGE OR VALUE (Default is shown in bold)	DESCRIPTIONS
Backlight	OFF, ON, Auto or Auto (DC IN:ON)	Selects the transceiver backlight option.
	5sec or 10sec	Selects the backlight ON time period.
	Bright or Dark	Selects the LCD backlight brightness level
LCD Contrast	1~ 8 ~16	Sets the contrast level of the LCD.
Busy LED	OFF or ON	Turns the TX/RX indicator ON or OFF.
RX Call Sign	OFF, Auto or Auto (RX Hold)	Selects the call sign display option when receiving a call.

☞ Continued on the next page.

6 MENU SCREEN OPERATION

■ Menu items and default settings (Continued)

/// **NOTE:** The default settings, shown below, are for the USA version.
/// The default settings may differ, depending on the version.

Display	In this item, set the Display options.	RANGE OR VALUE (Default is shown in bold)	DESCRIPTIONS
	RX Message	OFF or Auto	Selects to display and scroll a received message when receiving a call.
	DV RX Backlight	OFF or ON	Turns the DV RX Backlight function ON or OFF.
	TX Call Sign	OFF, Your Call Sign or My Call Sign	Selects whether or not to display My or Your call sign while transmitting.
	Scroll Speed	Slow or Fast	Selects the scrolling speed of the message, call sign, or other text.
	Opening Message	OFF or ON	Selects whether or not to display the opening message at power ON.
	Voltage Indication	OFF or ON	Selects whether or not to display the voltage of the battery or external DC power source at power ON.
	Display Language	English or Japanese	Selects the display language in the DR mode or Menu mode. When "English" is selected in System Language, this setting will disappear.
	System Language	English or Japanese	Selects English or Japanese as the system language of the transceiver.

/// **NOTE:** The default settings, shown below, are for the USA version.
 /// The default settings may differ, depending on the version.

Sounds		In this item, set the Sound options.		
			RANGE OR VALUE (Default is shown in bold)	DESCRIPTIONS
	Beep Level		0~ 3 ~9	Sets the beep output level.
	Beep/Vol Level Link		OFF or ON	Selects whether or not the beep output level can be adjusted by the [VOL] control.
	Key-Touch Beep		OFF or ON	Turns the confirmation beep tones when key is pushed, ON or OFF.
	Scan Stop Beep		OFF or ON	Turns the scan stop beep ON or OFF.
	Standby Beep		OFF, ON or ON (to me:High Tone)	Turns the standby beep function in the DV mode ON or OFF.
	Scope AF Output		OFF or ON	Selects the audio output capability during a sweep by the Band Scope function.

Time Set		In this item, set the Time options.		
			RANGE OR VALUE (Default is shown in bold)	DESCRIPTIONS
	Date/Time			Sets the current date and time.
	GPS Time Correct		OFF or Auto	Selects if the time data is automatically corrected by a received GPS sentence.
	UTC Offset		-14:00~ ±0:00 ~+14:00	Enters the time difference between UTC and the local time.
	Auto Power OFF		OFF , 30min, 60min, 90min or 120min	Turns the Auto power OFF function ON or OFF.

☞ Continued on the next page.

6 MENU SCREEN OPERATION

■ Menu items and default settings (Continued)

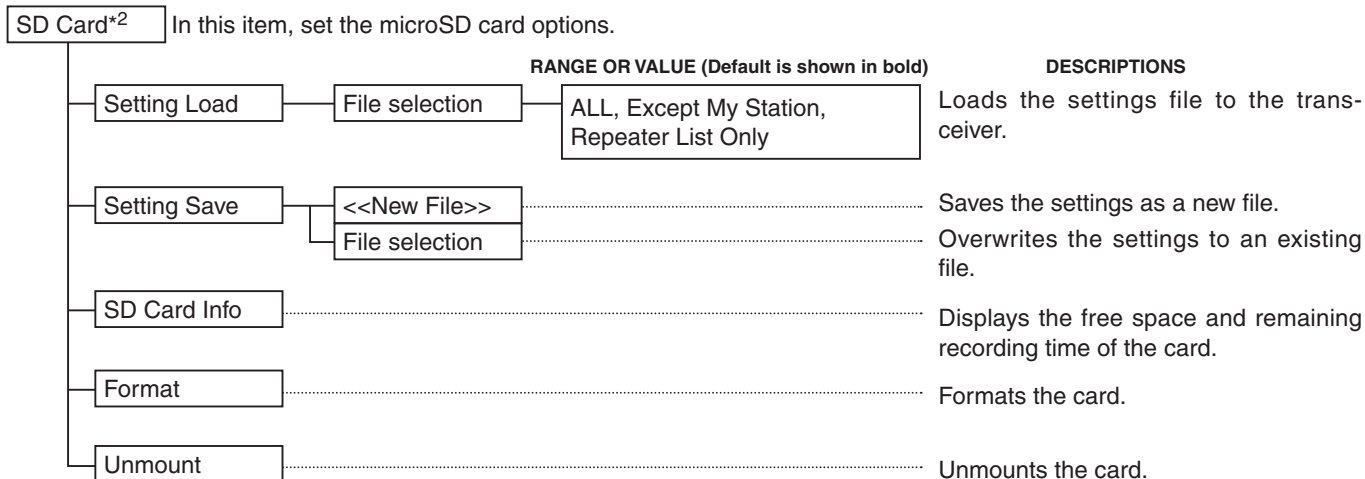

*² Be sure to insert the microSD card into the transceiver before selecting these items.

Resetting

The display may occasionally display erroneous information (e.g. when first applying power). This may be caused externally by static electricity or by other factors.

If this problem occurs, turn OFF power. After waiting a few seconds, turn ON power again. If the problem persists, perform either or both procedures below.



Partial reset

Use Partial reset if you want to initialize the operating conditions (VFO frequency, VFO settings, menu contents) without clearing the memory contents, call sign memories or repeater lists.

All reset





Reset the CPU, if the internal CPU malfunctions due to static electricity, etc. All reset clears all programming and returns all settings to their defaults.

Partial reset

- ① Hold down  for 1 second to turn OFF power.
- ② While holding down [V/MHz] , then hold down  for 1 second to turn ON power to partially reset the transceiver.
 - “PARTIAL RESET” appears when partially resetting the CPU.



All reset



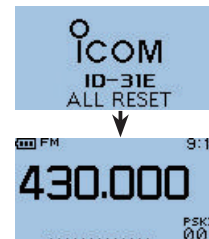
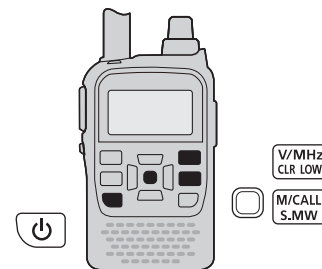

- ① Hold down  for 1 second to turn OFF power.
- ② While holding down [V/MHz] , [M/CALL]  and D-pad(Ent), then hold down  for 1 second to turn ON power to reset the CPU.
 - “ALL RESET” appears when resetting the CPU.





8

TROUBLESHOOTING

If your transceiver seems to be malfunctioning, please check the following points before sending it to a service center.

PROBLEM	POSSIBLE CAUSE	SOLUTION	REF.
Transceiver does not turn ON.	<ul style="list-style-type: none"> The battery is exhausted. The battery polarity is reversed. Loose connection of a battery pack (case). 	<ul style="list-style-type: none"> Charge the battery pack, or replace the batteries. Check the battery polarity. Clean battery terminals. 	pp. 1, 13–16 p. 15 –
No sound comes from the speaker.	<ul style="list-style-type: none"> Volume level is too low. An external speaker or a cloning cable is connected to the [SP] jack. 	<ul style="list-style-type: none"> Rotate [VOL] to adjust to a desired level. Check the external speaker connection or remove the cloning cable. 	p. 19 –
Transmitting is impossible.	<ul style="list-style-type: none"> A frequency outside of the 430 MHz amateur bands is set. The PTT Lock function is activated. 	<ul style="list-style-type: none"> Set the frequency within 430 MHz amateur bands. Set the PTT Lock function to OFF in the FUNCTION Menu. 	p. 23 p. 44
Transmitting using the VOX function is impossible.	<ul style="list-style-type: none"> The VOX Level is set to OFF or too low. The MIC Gain is too low. 	<ul style="list-style-type: none"> Set the VOX Level to a suitable level. Set the MIC Gain to a suitable level. 	p. 59 p. 45
Contacting with another station is impossible.	<ul style="list-style-type: none"> A different tone or code is used for the tone/DTCS squelch. 	<ul style="list-style-type: none"> Check the tone/DTCS by performing a tone scan. 	p. 27
Frequency cannot be set.	<ul style="list-style-type: none"> The Key Lock function is activated. The memory mode, Call channel mode, or DR mode is selected. 	<ul style="list-style-type: none"> Hold down [LOCK]  for 1 second to cancel the Key Lock function. Push [V/MHz]  to select the VFO mode. 	p. 26 p. 21
A program scan does not start.	<ul style="list-style-type: none"> The memory mode, Call channel mode, or DR mode is selected. The same frequency has been programmed in the scan edge channels, “*A” and “*B.” 	<ul style="list-style-type: none"> Push [V/MHz]  to select the VFO mode. Program different frequencies in the scan edge channels. 	p. 21 p. 28
A memory scan does not start.	<ul style="list-style-type: none"> The VFO mode or Call channel mode is selected. Only one or no memory channel has been programmed. 	<ul style="list-style-type: none"> Push [M/CALL]  to select the memory mode. Program two or more memory channels. 	p. 21 p. 28
The displayed frequency is erroneous.	<ul style="list-style-type: none"> The CPU has malfunctioned. External factors have caused a fault. 	<ul style="list-style-type: none"> Reset the transceiver. Remove and reattach the battery pack/case. 	p. 50 p. 1

• While operating D-STAR

PROBLEM	POSSIBLE CAUSE	SOLUTION	REF.
After your call, the repeater does not transmit a reply.	<ul style="list-style-type: none"> The repeater setting is wrong. The transceiver is out of the repeater range, or your transmission does not reach the repeater. 	<ul style="list-style-type: none"> Set the correct repeater. Correct the repeater frequency, frequency offset, or duplex setting. Try to access another repeater. 	Advanced Instruction Section 3
After your call, the repeater replies 'UR?' and its call sign.	<ul style="list-style-type: none"> The call was successfully sent, but no station's signal was immediately received. 	<ul style="list-style-type: none"> Wait for a while, and try it again. 	
After your call, the repeater replies 'RX' or 'RPT?' and the call sign of its gateway repeater.	<ul style="list-style-type: none"> MY call sign has not been set. Your call sign has not been registered to the D-STAR Server. Or it's wrong. Your calling station call sign has not been registered to the D-STAR Server. Or it's wrong. 	<ul style="list-style-type: none"> Set the MY call sign. Register your call sign to the D-STAR Server. Or confirm the registration of your call sign. Ask the server's administrator about your calling station's call sign. 	
After your call, the repeater replies 'RPT?' and call sign of the called repeater.	<ul style="list-style-type: none"> The D-STAR cannot connect to the called repeater, or it's busy. 	<ul style="list-style-type: none"> Wait for a while, and try it again. 	
After your call, the repeater replies 'RPT?' and its call sign.	<ul style="list-style-type: none"> The call sign of the called repeater is wrong. 	<ul style="list-style-type: none"> Correctly set the called repeater call sign. 	
Even holding down  , the DR mode will not appear.	<ul style="list-style-type: none"> The repeater list has been cleared. 	<ul style="list-style-type: none"> Reprogram the repeater list using the CS-31 cloning software. Reprogram the repeater list with the transceiver. 	
Even holding down  , the received call sign will not set to the operating call sign	<ul style="list-style-type: none"> The call sign has not been correctly received. 	<ul style="list-style-type: none"> Try it again, after the transceiver has again received its call sign. 	
The repeater does not accept your gateway call.	<ul style="list-style-type: none"> Your call sign has not been registered to the D-STAR system 	<ul style="list-style-type: none"> Ask your desired repeater's administrator about call sign registration. 	

◇ General

- Frequency coverage : (unit: MHz)

Version	TX	RX
U.S.A.	420-450*1	400-479*1
AUS	420-450*2	400-479*2
EUR, KOR	430-440	430-440
UK	430-440	400-479*2
ITR	430-434, 435-438	430-434, 435-438
EXP	400-479*2	400-479*2
EXP-1	430-440	400-479*2
CAN	430-450*1	400-479*1

*1Guaranteed 440-450 MHz only, *2Guaranteed 430-440 MHz only

- Mode : FM, FN-N, DV
- No. of memory channels : 552
(incl. 50 scan edges and 2 call channels)
- Usable temp. range : -20°C to +60°C; -4°F to +140°F
- Tuning steps : 5, 6.25, 10, 12.5, 15, 20, 25, 30, 50, 100, 125 and 200 kHz
- Frequency stability : ±2.5 ppm
(-20°C to +60°C; -4°F to +140°F)
- Power supply : 10.0-16.0 V DC for external DC power, or specified Icom's battery pack
- Digital transmission speed: 4.8 kbps
- Voice coding speed : 2.4 kbps
- Current drain (at 7.4 V DC) :

TX (at 5 W)	Less than 2.5 A
RX Max. output	Less than 350 mA (Internal speaker)
FM	Less than 200 mA (External speaker)
DV	Less than 450 mA (Internal speaker)
	Less than 300 mA (External speaker)
- Antenna connector : SMA (50 Ω)
- Dimensions : 58(W)×95(H)×25.4(D) mm;
(projections not included) 2.3(W)×3.7(H)×1(D) in

- Weight (approximately) : 140 g; 4.94 oz
(without battery pack/case and ant.)

◇ Transmitter

- Modulation system :

FM	Variable reactance freq. modulation
DV	GMSK reactance freq. modulation
- Output power (at 7.4 V DC) : High 5.0 W, Mid. 2.5 W, Low 0.5 W,
(Typical) S-Low 0.1 W
- Max. frequency deviation : ±5.0 kHz (FM wide: approx.)
±2.5 kHz (FM narrow: approx.)
- Spurious emissions : Less than -60 dBc at High/Mid.
Less than -13 dBm at Low/S-Low
- Ext. mic. impedance : 2.2 kΩ

◇ Receiver

- Receive system : Double-conversion superheterodyne
- Intermediate frequencies : 46.35 MHz (1st IF)
450 kHz (2nd IF)
- Sensitivity (except spurious points):

FM (1 kHz/3.5 kHz Dev.; 12 dB SINAD)	Less than -15 dBμ
DV (PN9/GMSK 4.8 kbps; BER 1%)	Less than -11 dBμ
- Audio output power (at 10% distortion)

Internal speaker	: More than 0.4 W with a 16 Ω load
External speaker	: More than 0.2 W with a 8 Ω load
- Selectivity :

FM (Wide)	More than 55 dB
FM (Narrow), DV	More than 50 dB
- Ext. speaker connector : 3-conductor 3.5(d) mm; (1/8")/8 Ω
- Spurious and image rejection ratio :
More than 60 dB
- Squelch Sensitivity (threshold, 1 kHz/3.5 kHz Dev.):
Less than -15 dBμ

All stated specifications are subject to change without notice or obligation.

- **BP-271** LI-ION BATTERY PACK
7.4 V/1150 mAh (Min.)/1200 mAh (Typ.) Lithium ion battery pack. Battery life: 4.5 hours (approximately; FM, high power, TX : RX: Standby = 1:1:8)
- **BP-272** LI-ION BATTERY PACK
7.4 V/1880 mAh (Min.)/2000 mAh (Typ.) Lithium ion battery pack. Battery life: 8 hours (approximately; FM, high power, TX : RX : Standby = 1:1:8)
- **BP-273** BATTERY CASE
Battery case for LR6 (AA) × 3 alkaline batteries.
- **BC-167SA/SD/SV** BATTERY CHARGER
For regular charging of the Lithium ion battery pack, BP-271 or BP-272.
Same as supplied one. (Not supplied with some version.)
- **BC-202** DESKTOP CHARGER+**BC-123SA/SE** AC ADAPTER
Rapidly charges BP-271 LI-ION BATTERY PACK in approximately 2 hours.
Rapidly charges BP-272 LI-ION BATTERY PACK in approximately 3.5 hours.
- **HM-75LS** REMOTE CONTROL SPEAKER MICROPHONE
Allows you to remotely select operating channels, etc.
- **HM-186LS** SPEAKER-MICROPHONE
For operation while conveniently hanging the transceiver from your belt, etc.
- **HM-153LS/HM-166LS** EARPHONE-MICROPHONE
Ideal for hands-free operation: clip the HM-153LS/HM-166LS (with integrated PTT switch) to your lapel or breast pocket. Allows you to operate in rainy condition.
- **SP-13** EARPHONE
Provides clear audio in noisy environments.
- **CP-12L** CIGARETTE LIGHTER CABLE WITH NOISE FILTER
- **CP-19R** CIGARETTE LIGHTER CABLE WITH DC-DC CONVERTER
Allows you to operate the transceiver through a 12 V cigarette lighter socket. You can also charge the attached battery pack (during stand-by only).
CP-19R: A built-in DC-DC converter provides an 11 V DC output.
- **HM-75A/HM-153/HM-166** MICROPHONE or **SP-13** EARPHONE
+**OPC-2144** PLUG ADAPTER CABLE
HM-75A : Remote control Speaker microphone
HM-153 : Earphone microphone
HM-166 : Earphone microphone
SP-13 : Speaker
OPC-2144 : Allows you to connect the HM-75A/HM-153/HM-166/HM-186/SP-13 to the transceiver.
- **HS-94/HS-95/HS-97** HEADSET
+**OPC-2006LS** PLUG ADAPTER CABLE
HS-94 : Ear hook type
HS-95 : Neck & arm type
HS-97 : Throat microphone
OPC-2006LS : Allows you to connect the HS-94/HS-95/HS-97 to the transceiver. After connecting, the VOX function can be used.

10 OPTIONS

- **OPC-254L** DC POWER CABLE
For operation and charging via an external power supply.
- **OPC-2218LU** DATA COMMUNICATION CABLE
Allows low-speed data communication in the DV mode, or data cloning operation with CS-31 (free download software).
- **LC-178** CARRYING CASE
Helps protect the transceiver from scratches, etc.
- **AD-92SMA** ANTENNA CONNECTOR ADAPTER
Allows you to connect an external antenna with a BNC connector.
- **CS-31** CLONING SOFTWARE (free download)
Use this software to program settings such as memory channels and Menu mode contents quickly and easily via your USB port (OPC-2218LU).
- **CT-17** CI-V LEVEL CONVERTER UNIT
For remote transceiver control using a personal computer equipped with an RS-232C port. You can change frequencies, operating mode, memory channels, etc., via your computer.

Approved Icom optional equipment is designed for optimal performance when used with an Icom transceiver. Icom is not responsible for the destruction or damage to an Icom transceiver in the event the Icom transceiver is used with equipment that is not manufactured or approved by Icom.

■ Optional HM-75LS REMOTE CONTROL SPEAKER MICROPHONE

The optional HM-75LS allows you to remotely select operating frequencies, memory channels, etc.

Remote control functions can be selected from three settings. These can be selected with “MIC Simple Mode” in the FUNCTION menu.

MENU ⇨ FUNCTION ⇨ **MIC Simple Mode** (p. 44)

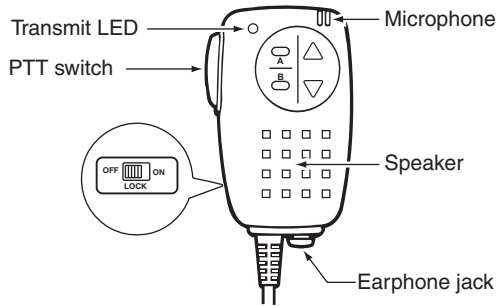

The HM-75LS has a lock switch on the backside to prevent accidental frequency changes, and so on.

⚡ Be sure to turn power OFF when plugging or unplugging the HM-75LS to and from the [SP/MIC] jack.

• SIMPLE:

[A]	Toggles the Monitor function
[B]	Turns the Call channel mode
[▲]	Select memory channel 0
[▼]	Select memory channel 1

• NORM-1: (default)

[A]	Selects the Call channel mode
[B]	Toggles the VFO mode and Memory mode
[▲]	Frequency or memory channel 'UP'
[▼]	Frequency or memory channel 'DOWN'

• NORM-2:

[A]	Turns the Monitor function
[B]	Toggles the VFO mode and Memory mode
[▲]	Frequency or memory channel 'UP'
[▼]	Frequency or memory channel 'DOWN'

The SIMPLE mode can select only three channels, and is useful for group operations during touring, and so on.

⚡ The VFO mode cannot be selected from the microphone when Simple mode is selected.

10 OPTIONS

■ HM-75LS REMOTE CONTROL SPEAKER MICROPHONE (Continued)

• COMMON (SIMPLE/NORM-1/NORM-2):

[A]	Transmits T-CALL (1750 Hz tone) while pushing [PTT]
[B]	—
[▲]	Volume 'UP' while operating the Monitor function
[▼]	Volume 'DOWN' while operating the Monitor function

○ When transceiver is in the DR mode:

Regardless of the "MIC Simple Mode" setting in FUNCTION menu, the Remote control microphone functions on the DR mode.

[A]	Enters UR call sign or link repeater selection (TO)
[B]	Enters Access repeater selection (FROM)
[▲]	Selects 'UP' on the displayed items
[▼]	Selects 'DOWN' on the displayed items

■ LC-178 CARRYING CASE

CAUTION:

When removing the carrying case from the transceiver, slide the side parts to the direction of the arrows.

NEVER pull the bottom part of the carrying case. Otherwise the carrying case may be damaged.

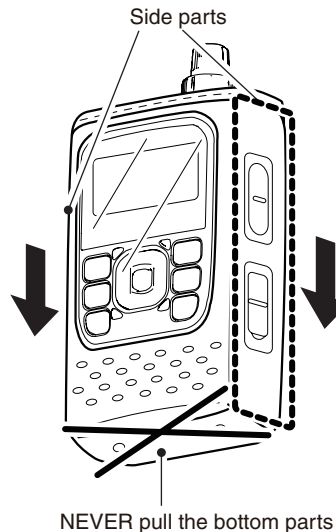

■ VOX function

The transceiver has a VOX function, which allows hands-free operation.

An optional HS-94, HS-95 or HS-97 headset and the OPC-2006LS plug adapter cable are also required.

- The VOX (voice operated transmission) function starts transmission when you speak into the microphone, without needing to push [PTT], then automatically returns to reception when you stop speaking.

◇ Optional unit connection

- ① Hold down  for 1 second to turn the power OFF.
- ② Remove the jack cover.
- ③ Connect the HS-94, HS-95 or HS-97 and the OPC-2006LS, as illustrated below.

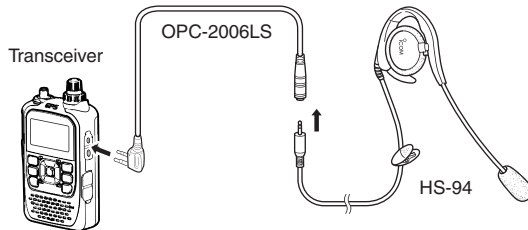

 Be sure to turn power OFF when plugging in or unplugging the OPC-2006LS to or from the [SP/MIC] jack.

◇ Selecting the headset type

- ① Turn ON the transceiver.
- ② Push [MENU]  to enter the Menu screen.
- ③ Push D-pad(↑) to select the root item (Function), and then push D-pad(Ent) to go to the next screen.

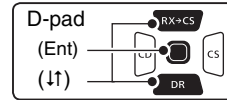

(MENU ⇄ FUNCTION ⇄ VOX ⇄ **Headset Select**)

- ③ Refer to the menu sequence show directly above and push D-pad(↑) to select, and then D-pad(Ent) to enter, one or more times until the last screen is displayed.
- ④ Push D-pad(↑) to select the option.
 HS-95 : Select when using the HS-95.
 Other : Select when using the HS-94 or HS-97.
- ⑤ Push [MENU]  to exit the Menu screen.

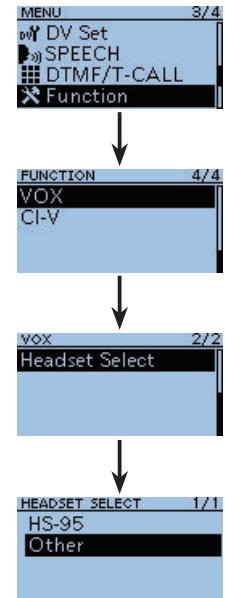

10 OPTIONS

◆ Turning the VOX function ON or OFF

- ① Push [MENU]  to enter the Menu screen.
- ② Push D-pad(↑) to select the root item (Function), and then push D-pad(Ent) to go to the next screen.

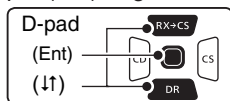

(MENU ⇨ FUNCTION ⇨ VOX ⇨ **VOX**)

- ③ Refer to the menu sequence show directly above and push D-pad(↑) to select, and then D-pad(Ent) to enter, one or more times until the last screen is displayed.
- ④ Push D-pad(↑) to select “ON.”
- ⑤ Push [MENU]  to exit the Menu screen.
 - “VOX” appears.

 Set the microphone gain before setting the VOX gain in the Menu screen. We recommend setting the microphone gain to 3.

(MENU ⇨ FUNCTION ⇨ VOX ⇨ **MIC Gain (External)**)

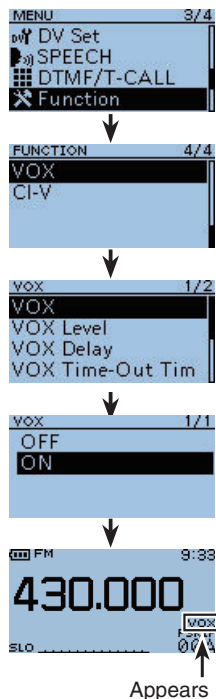

◆ VOX-related settings

The VOX Level, the VOX Delay, and the VOX time-out timer can be set in the Menu screen.

• VOX Level

- ① Push [MENU]  to enter the Menu screen.
- ② Push D-pad(↑) to select the root item (Function), and then push D-pad(Ent) to go to the next screen.

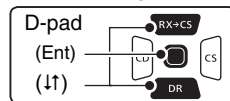

(MENU ⇨ FUNCTION ⇨ VOX ⇨ **VOX Level**)

- ③ Refer to the menu sequence show directly above and push D-pad(↑) to select, and then D-pad(Ent) to enter, one or more times until the last screen is displayed.
- ④ While speaking into the headset microphone, adjust the VOX Level until “VOX” continuously appears.
 - The VOX Level can be adjusted between 1 (minimum) and 10 (maximum), or turned OFF. Higher values make the VOX function more sensitive to your voice. (default: 5)

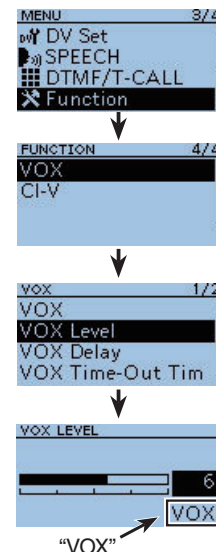

 You cannot use the VOX function or transmit while in the Menu screen.

✓ **CONVENIENT!**

While transmitting using the VOX function, you can adjust the VOX gain simply by rotating [DIAL].

- The VOX level appears.

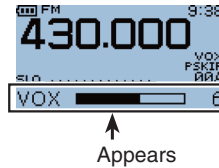

• **VOX delay**

Sets the VOX delay to between 0.5 and 3.0 seconds (in 0.5 seconds steps). The VOX delay is the amount of time the transmitter stays ON after you stop speaking. (default: 0.5) (MENU⇨ FUNCTION⇨ VOX⇨ **VOX Delay**)

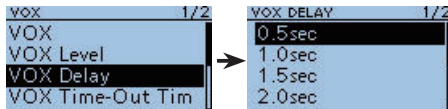

/// If "VOX" is intermittent, be sure the VOX delay is set long enough to allow normal pauses in speech, turn the VOX OFF after you finish speaking.

• **VOX time-out timer**

Sets the VOX Time-Out Timer to between 1, 2, 3, 4, 5, 10 and 15 minutes to prevent accidental prolonged transmission.

To turn the function OFF, select "OFF" (default: 3) (MENU⇨ FUNCTION⇨ VOX⇨ **VOX Time-out Timer**)

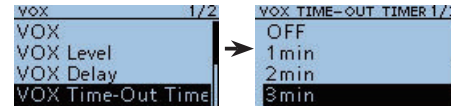

/// The VOX Time-Out Timer must be set shorter than the transceiver Time-Out Timer, otherwise this timer will not be activated.

11 COUNTRY CODE LIST

• ISO 3166-1

	Country	Codes		Country	Codes
1	Austria	AT	18	Liechtenstein	LI
2	Belgium	BE	19	Lithuania	LT
3	Bulgaria	BG	20	Luxembourg	LU
4	Croatia	HR	21	Malta	MT
5	Czech Republic	CZ	22	Netherlands	NL
6	Cyprus	CY	23	Norway	NO
7	Denmark	DK	24	Poland	PL
8	Estonia	EE	25	Portugal	PT
9	Finland	FI	26	Romania	RO
10	France	FR	27	Slovakia	SK
11	Germany	DE	28	Slovenia	SI
12	Greece	GR	29	Spain	ES
13	Hungary	HU	30	Sweden	SE
14	Iceland	IS	31	Switzerland	CH
15	Ireland	IE	32	Turkey	TR
16	Italy	IT	33	United Kingdom	GB
17	Latvia	LV			

A

ABOUT SUPPLIED CD	vi
About using a microSD card	3
ACCESSORY ATTACHMENT	1
All reset	50
Antenna	2
ANTENNA CONNECTOR	5

B

Band Scope function	31
BASIC OPERATION	19
Battery caution	11
BATTERY CHARGING	11
Battery icon	13, 17
BATTERY ICON	9
Battery information	17
Battery life	17
Battery pack	1
Belt clip	2
BK ICON	9

C

Call channels.....	22
Caution	11
CD (RX CALL RECORD) KEY	8
Charging caution	12

Charging note	13, 14
Charging period (Rapid charging)	14
Charging period (Regular charging)	13
CLEAR KEY	6
CLOCK DISPLAY	10
Contents that can be stored onto a card	3
Continuous Sweep	31
CONTROL DIAL	7
COUNTRY CODE LIST	61
CS (CALL SIGN) KEY	8

D

DATA JACK	6
DC IN JACK	6
DIAL	7
DOWN KEY	8
D-PAD	8
DR (D-STAR REPEATER) KEY	8
DR (D-STAR Repeater) mode	22
DUPLEX ICON	9

E

EMR/BK ICON	9
Entering the MENU screen and operation	32
ENTER KEY	8

O		Receiver.....	53
OPERATING MODE ICONS	9	Receiving	24
Operating mode selection	24	Regular charging	13
Operating note	18	Repeater operation	29
Optional battery case	15	Resetting	50
Optional HM-75LS		RF METER	10
REMOTE CONTROL SPEAKER MICROPHONE	56	RIGHT KEY	8
Optional unit connection	58	RX INDICATOR.....	5
OPTIONS	54	RX→CS (RX CALL SIGN SET) KEY	8
OUTPUT POWER KEY	6	S	
P		Scan function	27
PANEL DESCRIPTION	5	Selecting the headset type	58
Partial reset	50	SELECT MEMORY WRITE KEY	6
POWER ICONS	10	Setting a frequency	23
POWER KEY	6	Setting a tuning step	23
Power ON	19	Setting audio volume	19
PRECAUTIONS	iii	Setting squelch level	20
PRIORITY WATCH ICON	9	Setting the duplex direction	30
PTT SWITCH	5	Setting the subaudible tone	30
Q		Single Sweep	31
QUICK MENU KEY	6	SKIP ICON	10
R		SPEAKER/MICROPHONE JACK	7
Rapid charging	14	SPECIFICATIONS	53
		SQUELCH KEY	5
		S/RF METER	10
		Starting the CD	vi

INDEX

SUPPLIED ACCESSORIES	vii
Sweep operation	31

T

TONE ICONS	9
Transmit power selection.....	26
Transmitter.....	53
Transmitting	25
TROUBLESHOOTING.....	51
Tuning step selection	23
Turning the VOX function ON or OFF	59
TX/RX INDICATOR	5

U

UP KEY	8
Usable microSD cards.....	3

V

VFO/MHz • CLEAR • OUTPUT POWER KEY.....	6
VFO mode	21
VOLUME CONTROL	7
VOX delay	60
VOX function	58
VOX ICON	10
VOX-related settings	59
VOX time-out timer	60

MEMO

MEMO

Count on us!

#02 Europe

<Intended Country of Use>											
<input checked="" type="checkbox"/>	AT	<input checked="" type="checkbox"/>	BE	<input checked="" type="checkbox"/>	CY	<input checked="" type="checkbox"/>	CZ	<input checked="" type="checkbox"/>	DK	<input checked="" type="checkbox"/>	EE
<input checked="" type="checkbox"/>	FI	<input checked="" type="checkbox"/>	FR	<input checked="" type="checkbox"/>	DE	<input checked="" type="checkbox"/>	GR	<input checked="" type="checkbox"/>	HU	<input type="checkbox"/>	IE
<input type="checkbox"/>	IT	<input checked="" type="checkbox"/>	LV	<input checked="" type="checkbox"/>	LT	<input checked="" type="checkbox"/>	LU	<input checked="" type="checkbox"/>	MT	<input checked="" type="checkbox"/>	NL
<input checked="" type="checkbox"/>	PL	<input checked="" type="checkbox"/>	PT	<input checked="" type="checkbox"/>	SK	<input checked="" type="checkbox"/>	SI	<input checked="" type="checkbox"/>	ES	<input checked="" type="checkbox"/>	SE
<input type="checkbox"/>	GB	<input checked="" type="checkbox"/>	IS	<input checked="" type="checkbox"/>	LI	<input checked="" type="checkbox"/>	NO	<input checked="" type="checkbox"/>	CH	<input checked="" type="checkbox"/>	BG
<input checked="" type="checkbox"/>	RO	<input checked="" type="checkbox"/>	TR	<input checked="" type="checkbox"/>	HR						

#03 U.K.

<Intended Country of Use>											
<input type="checkbox"/>	AT	<input type="checkbox"/>	BE	<input type="checkbox"/>	CY	<input type="checkbox"/>	CZ	<input type="checkbox"/>	DK	<input type="checkbox"/>	EE
<input type="checkbox"/>	FI	<input type="checkbox"/>	FR	<input type="checkbox"/>	DE	<input type="checkbox"/>	GR	<input type="checkbox"/>	HU	<input checked="" type="checkbox"/>	IE
<input type="checkbox"/>	IT	<input type="checkbox"/>	LV	<input type="checkbox"/>	LT	<input type="checkbox"/>	LU	<input type="checkbox"/>	MT	<input type="checkbox"/>	NL
<input type="checkbox"/>	PL	<input type="checkbox"/>	PT	<input type="checkbox"/>	SK	<input type="checkbox"/>	SI	<input type="checkbox"/>	ES	<input type="checkbox"/>	SE
<input checked="" type="checkbox"/>	GB	<input type="checkbox"/>	IS	<input type="checkbox"/>	LI	<input type="checkbox"/>	NO	<input type="checkbox"/>	CH	<input type="checkbox"/>	BG
<input type="checkbox"/>	RO	<input type="checkbox"/>	TR	<input type="checkbox"/>	HR						

#04 Italy

<Intended Country of Use>											
<input type="checkbox"/>	AT	<input type="checkbox"/>	BE	<input type="checkbox"/>	CY	<input type="checkbox"/>	CZ	<input type="checkbox"/>	DK	<input type="checkbox"/>	EE
<input type="checkbox"/>	FI	<input type="checkbox"/>	FR	<input type="checkbox"/>	DE	<input type="checkbox"/>	GR	<input type="checkbox"/>	HU	<input type="checkbox"/>	IE
<input checked="" type="checkbox"/>	IT	<input type="checkbox"/>	LV	<input type="checkbox"/>	LT	<input type="checkbox"/>	LU	<input type="checkbox"/>	MT	<input type="checkbox"/>	NL
<input type="checkbox"/>	PL	<input type="checkbox"/>	PT	<input type="checkbox"/>	SK	<input type="checkbox"/>	SI	<input type="checkbox"/>	ES	<input type="checkbox"/>	SE
<input type="checkbox"/>	GB	<input type="checkbox"/>	IS	<input type="checkbox"/>	LI	<input type="checkbox"/>	NO	<input type="checkbox"/>	CH	<input type="checkbox"/>	BG
<input type="checkbox"/>	RO	<input type="checkbox"/>	TR	<input type="checkbox"/>	HR						

A-6986H-1EX-②

Printed in Japan

© 2011–2014 Icom Inc.

Printed on recycled paper with soy ink.

Icom Inc.

1-1-32 Kamiminami, Hirano-ku, Osaka 547-0003, Japan