

ID-31A/ID-31E

Firmware update information

Thank you for using the Icom Download Service.

■ General

The ID-31A/ID-31E's firmware can be updated if desired. By updating the firmware, new function(s) can be added and performance can be improved.

/// This firmware cannot be updated using a microSD card. Refer the "◇ System requirement" to the right.

◇ System requirement

To use this firmware updater, the following computer systems and items are required:

• Operating System (OS)

- Microsoft® Windows® XP (32bit)
- Microsoft® Windows Vista® (32bit)
- Microsoft® Windows® 7 (32/64bit)

• Others

- Optional OPC-2218LU DATA CABLE
- A USB 1.1 or 2.0 port

■ USB driver installation

To use the OPC-2218LU DATA CABLE between the transceiver and the PC, you must install a USB driver. The latest USB driver and installation guide can be downloaded from the Icom website.



Please read the guide before installing the driver.

/// CAUTION:

- **NEVER** connect the transceiver to the PC with the OPC-2218LU DATA CABLE until the USB driver installation has been completed.
- The driver is not supported by the Windows® automatic recognition system.

■ Firmware confirmation

The transceiver's firmware version can be confirmed while turning ON the power.

- ➔ While holding down [MENU]  and D-pad(Ent), hold down  for 1 second to turn ON the power.
 - While continuing to hold down either [MENU]  or D-pad(Ent), the CPU and DSP firmware versions are displayed on the bottom line.

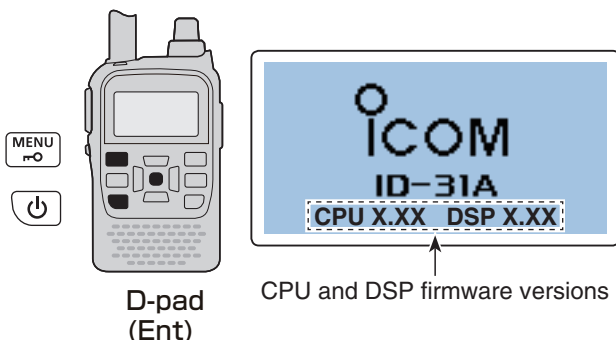

■ Caution

CAUTION: NEVER turn OFF the transceiver power while updating the firmware.

If you turn the transceiver power OFF, or if a power failure occurs while updating, the transceiver firmware will be corrupted. In that case, try to rewrite the firmware referring the "■ Update failure" on page 4. If the transceiver's firmware is still corrupted, you will have to send the transceiver back to the nearest Icom distributor for repair. This type of repair is out of warranty even if the warranty period is still valid.

Recommendation!

- Backing up all the transceiver's data to the microSD card or PC before starting the firmware update is strongly recommended. Settings and/or memory contents will be lost or returned to their default settings when the firmware update is performed.
- Fully charging of battery pack before starting the firmware update is strongly recommended. This is to avoid failure during the update, caused by an unexpected power failure.

Icom, Icom Inc. and the Icom logo are registered trademarks of Icom Incorporated (Japan) in Japan, the United States, the United Kingdom, Germany, France, Spain, Russia and/or other countries. Microsoft, Windows and Windows Vista are registered trademarks of Microsoft Corporation in the United States and/or other countries. All other products or brands are registered trademarks or trademarks of their respective holders.

■ Firmware update

When starting the firmware update, log on as the **administrator**.

- ① Make sure Windows has completed its start-up, and no other applications are running.
- ② Start up the ID-31 Firmware updater.
 - The window to the right appears.
- ③ Carefully read the caution in the window.
- ④ Click [Yes] if you agree, then continue the firmware updating.

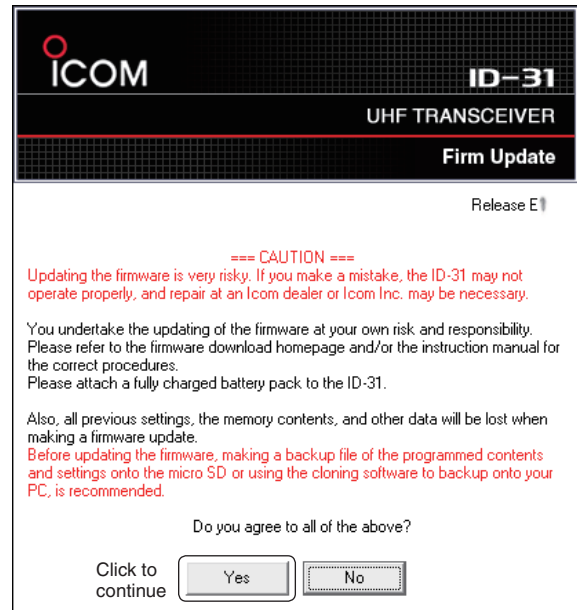

- ⑤ The window to the right appears.
- ⑥ Connect the transceiver and PC using the optional OPC-2218LU data cable.
 - Be sure to turn OFF the transceiver power before connecting the cable.

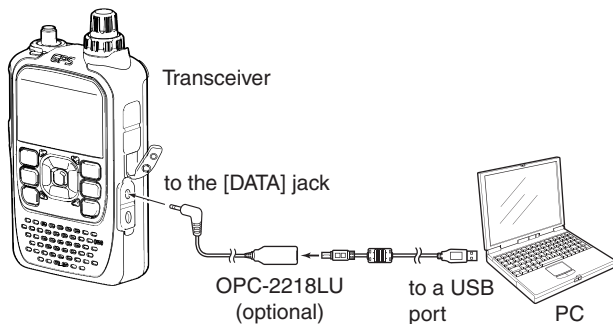

- ⑦ While holding down [V/MHz] (V/MHz CLR LOW), [QUICK MENU] and [SQL], hold down [POWER] for 1 second to turn ON the power.
 - The display shows the CPU and DSP firmware versions, and the display backlight blinks.

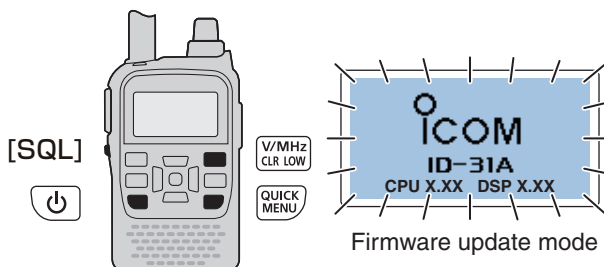

- ⑧ Select the specific COM port number from the drop down menu to the window to the right above (1), and then click [OK] (2).

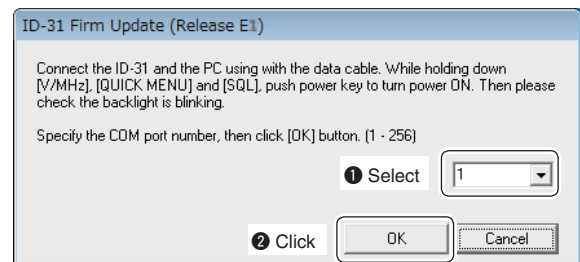

(Continued to step ⑨ on the next page...)

(Continued on the next page...)

■ Firmware update (Continued)

- ⑨ The window to the right appears.
- ⑩ Click [Yes] if you want to start the firmware update.

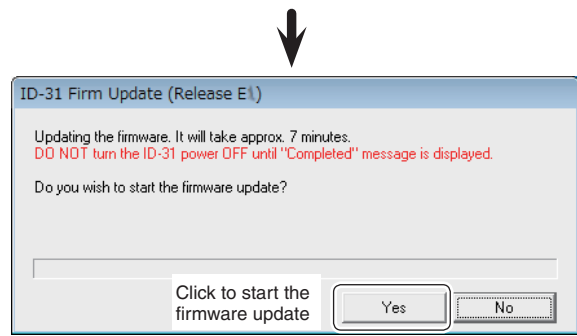

- ⑪ The window to the right appears.
- ⚠ **WARNING! NEVER** turn OFF the transceiver power or disconnect the cable at this stage. The transceiver firmware will be corrupted.

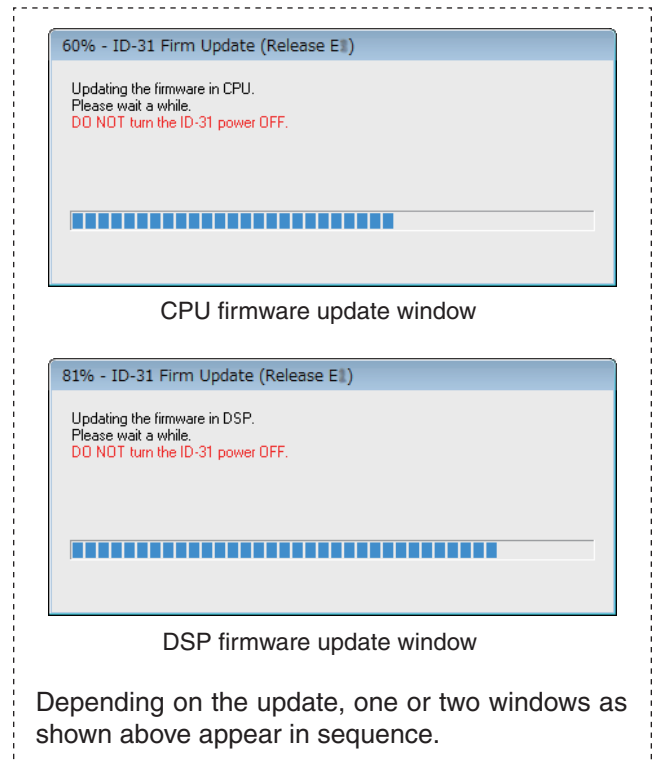

- ⑫ The window to the right appears.
- ⑬ Click [OK] to finish the firmware update.
 - The transceiver automatically restarts.
- ⑭ If the update was successful, reprogram your settings to the desired values, and reinstall your memories and lists from your backup data.

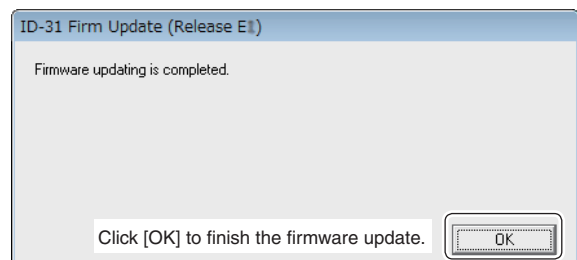

■ Update failure

• CPU update failure

- 1 If a power failure or loose connection of the cable occurs while updating the CPU firmware, the window to the right appears.
- 2 Detach the battery pack from the transceiver, then reattach it.
 - The transceiver automatically turns ON, then the display is blank and its backlight blinks.
- 3 Click [OK] to finish the firmware update, then restart the ID-31 Firmware updater again.
- 4 Repeat “■ Firmware update” on pages 2 and 3.
 - The transceiver is already in the Firmware update mode; skip steps ⑥ and ⑦, then follow the procedures from step ⑧.
- 5 The window to the right appears, and then click [OK] to finish the firmware update.
 - The transceiver automatically restarts.
- 6 If the update was successful, reprogram your settings to the desired values, and reinstall your memories and lists from your backup data.

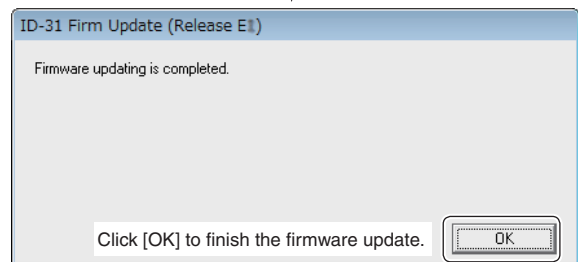
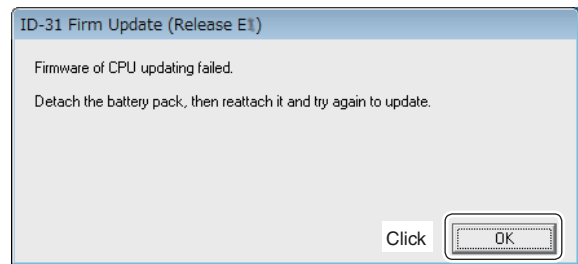

• DSP update failure

- 1 If a power failure or loose connection of the cable occurs while updating the DSP firmware, the window to the right appears.
- 2 Detach the battery pack from the transceiver, then reattach it.
 - The transceiver automatically turns ON.
- 3 Hold down  for 1 second to turn OFF the power.
- 4 Click [OK] to finish the firmware update, then restart the ID-31 Firmware updater again.
- 5 Repeat “■ Firmware update” on pages 2 and 3.
 - If the transceiver and PC are already connected; skip step ⑥, then follow the procedures from step ⑦.
- 6 The window to the right appears, and then click [OK] to finish the firmware update.
 - The transceiver automatically restarts.
- 7 If the update was successful, reprogram your settings to the desired values, and reinstall your memories and lists from your backup data.

