



CI-V

Icom Communication Interface - V

Reference manual

FOREWORD

We have introduced the CI-V (Icom Communication Interface-V) System, an advanced remote control LAN (Local Area Network).

With this system, you can control Icom's recent HF transceivers, all mode transceivers and nearly all receivers remotely.

A variety of functions including the operating frequency, mode and memory channel can be changed via your personal computer.

EXPLICIT DEFINITIONS

The following explicit definitions apply to this reference manual.

Word	Definition
 WARNING	Personal injury, fire hazard or electric shock may occur.
CAUTION	Equipment damage may occur.
NOTE	If ignored, inconvenience only. No personal injury or risk of electric shock.

PRECAUTIONS

 **NEVER** connect the CT-17 CI-V LEVEL CONVERTER to an AC outlet. This will ruin any connected equipment and electric shock may occur.

DISCONNECT all AC and DC power cables from the radios before performing any connections or internal work.

DO NOT apply more than 15 V DC to the CT-17. Check power source voltage before connecting the DC power cable.

If a non-Icom CI-V level converter is used, accurate operation is not guaranteed. The use of Icom's CT-17 is recommended.

Icom has strived to make all information as precise as possible. However, **NO** liability is accepted with respect to the use of the information herein. To include the newest information, all stated contents are subject to change without notice or obligation.

INTRODUCTION

This reference manual explains the basic theory of the CI-V System, general operating method, and all current functions.

Available functions differ according to radios. (Section 4)

Before operation, condition setting **MUST** be performed for both your personal computer and each radio. (Sections 2-1~2-11)

Parameter setting methods differ according to computers and programming languages. Refer to the instruction manual of your computer and programming language. (Section 2-7)

APPLICABLE RADIOS

	Model
HF transceivers	IC-725, IC-726, IC-728, IC-729, IC-735, IC-737, IC-751, IC-751A, IC-761, IC-765, IC-781
All mode transceivers	IC-271A/E/H, IC-471A/E/H, IC-1271A/E, IC-575A/H, IC-275A/E/H, IC-375A, IC-475A/E/H, IC-1275A/E, IC-970A/E/H
Receivers	IC-R71A/E/D, IC-R72, IC-R7000, IC-R7100, IC-R9000

SOFTWARE

Commercially-made software from other companies may be available for the CI-V System. Freeware or shareware may be available from BBS's or RBBS's. Ask your Icom Dealer for details.

Icom does not yet supply any software for the CI-V System. However, the later pages of the CT-17 instruction manual include sample programs. All programs **MUST** be modified to suit your computer.

COPYRIGHT

All rights for the CI-V System and this reference manual are reserved by Icom Inc. Production or publication of the content in any manner, without express permission of Icom Inc. is prohibited.

TABLE OF CONTENTS

FOREWORD.....	i	5. MESSAGE FORMAT	pgs. 5-1~5-4
EXPLICIT DEFINITIONS.....	i	5-1 Basic message format.....	p. 5-1
PRECAUTIONS.....	i	5-2 Frequency data format.....	p. 5-3
INTRODUCTION	i	5-3 Memory blank code.....	p. 5-3
APPLICABLE RADIOS.....	i	5-4 Jammer code.....	p. 5-3
PROGRAMS.....	i	5-5 Preamble code.....	p. 5-4
COPYRIGHT.....	i	5-6 End of message code.....	p. 5-4
TABLE OF CONTENTS.....	ii		
1. WHAT IS THE CI-V SYSTEM?	pgs. 1-1~1-2	6. SPECIAL CHANNEL NUMBER AND MODE DATA	pgs. 6-1~6-2
1-1 Advanced remote control.....	p. 1-1	6-1 What are special memory channel numbers?	p. 6-1
1-2 Features.....	p. 1-1	6-2 Scan edge channels for the IC-R9000	p. 6-1
1-3 History of the CI-V System.....	p. 1-1	6-3 Scan edge channels for the IC-R7100	p. 6-1
1-4 Required equipment.....	p. 1-2	6-4 Other special memory channel numbers.....	p. 6-1
1-5 How to prevent RFI.....	p. 1-2	6-5 Special memory channel access example	p. 6-1
1-6 CSMA/CD System	p. 1-2	6-6 Mode and IF passband width tables	p. 6-2
1-7 Transceivers and receivers.....	p. 1-2		
1-8 Data transmission system.....	p. 1-2		
1-9 Decimal and hexadecimal values.....	p. 1-2		
1-10 BCD code.....	p. 1-2		
2. PRE-SETTINGS	pgs. 2-1~2-3	7. COMMAND DESCRIPTION	pgs. 7-1~ 7-24
2-1 Pre-setting outline.....	p. 2-1	7-1 Transceive commands.....	p. 7-1
2-2 Changing CI-IV to CI-V.....	p. 2-1	7-2 Upper/lower-edge frequency readout command.....	p. 7-3
2-3 Baud rate for radios.....	p. 2-1	7-3 Operating frequency, mode readout commands.....	p. 7-4
2-4 Baud rate modification	p. 2-1	7-4 Operating frequency, mode writing commands.....	p. 7-5
2-5 Address numbers for each radio.....	p. 2-2	7-5 VFO selection command	p. 7-6
2-6 Address number modification.....	p. 2-2	7-6 Front window selection command	p. 7-7
2-7 Personal computer conditions.....	p. 2-2	7-7 Memory channel commands.....	p. 7-8
2-8 Address number for the controller.....	p. 2-2	7-8 Offset frequency commands.....	p. 7-11
2-9 What is the transceive function?	p. 2-3	7-9 Scan start/stop command	p. 7-12
2-10 Transceive function ON/OFF	p. 2-3	7-10 Scan condition command.....	p. 7-13
2-11 Operating frequency data length.....	p. 2-3	7-11 Sub commands for command 0EH	p. 7-14
 		7-12 Basic window scan command	p. 7-15
3. CONNECTIONS	p. 3-1	7-13 Advanced window scan start/stop command.....	p. 7-16
3-1 Connection outline	p. 3-1	7-14 Split and duplex command	p. 7-18
3-2 RS-232C cable connection.....	p. 3-1	7-15 Tuning step command.....	p. 7-19
3-3 Mini-plug cable connection.....	p. 3-1	7-16 Other commands.....	p. 7-20
3-4 DC power supply connection	p. 3-1		
4. COMMAND TABLES.....	pgs. 4-1~4-3		

1-1 Advanced remote control

The CI-V System enables you to control radio functions while your radio is not at hand. Instead of the radio's front panel, you can use a personal computer.

Most recent Icom radios have a CPU, also known as a microprocessor. Each CPU is programmed to communicate with an external remote controller or CPUs in other radios. In the CI-V System, the remote controller means a personal computer connected via an optional CT-17 CI-V LEVEL CONVERTER.

You can utilize the state-of-the-art CI-V System to change operating frequency or mode, to activate a scan function, and more while you are away from your radio. What a convenient system!

After you have typed in a computer command, the computer converts the command to signals which another radio's CPU accepts. Signals conform to a pattern for communication between computer and radio.

The following sections describe how to control your radio with your computer.

1-2 Features

The CI-V System allows easy computer control of a variety of radios. Listed below are only some of its sophisticated features.

- Remote control for up to 4 radios. (Section 3-1)
- Operating frequency selection. (Section 7-4)
- Operating mode selection. (Section 7-4)
- Memory channel selection. (Section 7-7)
- Memory writing. (Section 7-7)
- Scan control. (Sections 7-9-7-13)
- Automatic operating frequency and mode data transfer between radios. (Sections 2-9, 7-1)
- Serial data communication based on the CSMA/CD (Carrier Sense Multiple Access with Collision Detection) System. (Section 1-6)

1-3 History of the CI-V System

The CI-V System is Icom's 5th communication interface product. Either the CI-IV or CI-V System have been installed in recent HF, all mode and almost all receivers. (Section 2-2)

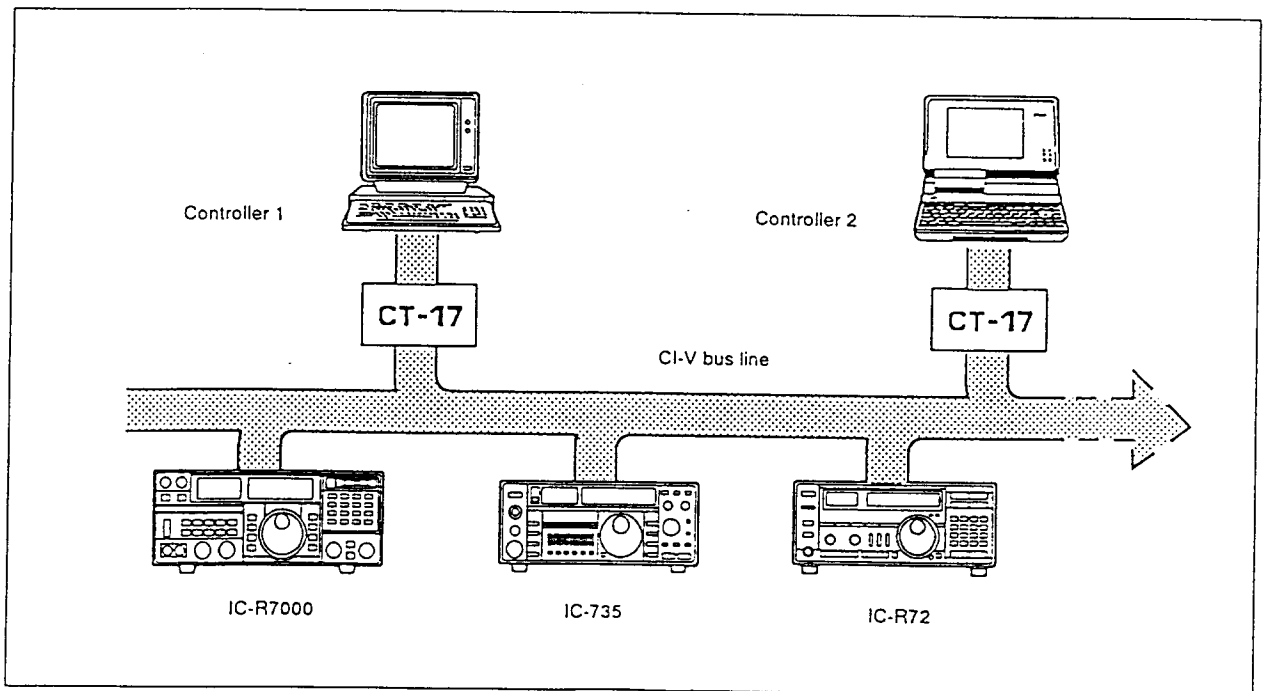

Fig. 1-1

1-4 Required equipment

To control CI-V radios, a personal computer equipped with an EIA standard RS-232C I/O port is required.

Icom offers the following options for the CI-V System.

■ CT-17 CI-V LEVEL CONVERTER

Using the CT-17, CI-V radios can be externally controlled with a personal computer. Up to 4 CI-V radios can be connected to the CT-17. (Section 3-1)

■ UX-14 CI-IV/CI-V CONVERTER

Required only for radios equipped with the CI-IV System. The UX-14 allows a CI-IV radio to utilize the CI-V System. (Section 2-2)

1-5 How to prevent RFI

Computer equipment that is set near a radio may cause RFI (Radio Frequency Interference). Following are a few ways to prevent RFI:

- Keep well matched antennas away from the computer.
- Keep coaxial cables away from the computer.
- Use an AC line filter for a computer AC power cable.
- Use the shortest and heaviest possible gauge wire or strap for computer grounding.

1-6 CSMA/CD System

The CSMA/CD (Carrier Sense Multiple Access with Collision Detection) System is a way to manage the CI-V System. The system keeps the CI-V bus line as free as possible of useless messages and raises bus line efficiency to over 90%.

During data transmission, the radio which is transmitting a message monitors the CI-V bus line simultaneously. If message collisions are detected, the radio halts the message transmission. After waiting for a programmed period of time, the radio sends the previous message again. (Section 5-4)

1-7 Transceivers and receivers

In this manual, the word "radio" refer to both transceivers and receivers.

1-8 Data transmission system

The CT-17 and each radio exchange serial information using NRZ (Non Return to Zero) format. Fig. 1-2 below shows an example of 1-byte data composition.

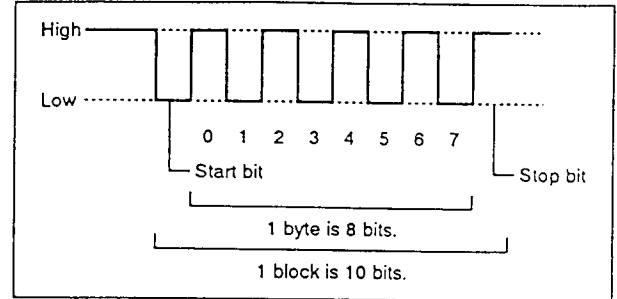

Fig. 1-2

1-9 Decimal and hexadecimal values

In this manual, a value is usually base 16, a hexadecimal value.

Hexadecimal value	0H	1H	2H	3H	4H	5H	6H	7H
Decimal value	0	1	2	3	4	5	6	7
Hexadecimal value	8H	9H	AH	BH	CH	DH	EH	FH
Decimal value	8	9	10	11	12	13	14	15

Table 1-1

1-10 BCD code

For frequency data, the memory channel number and every other data **MUST** be specified in BCD (Binary Coded Decimal) code. Refer to Table 1-3 below.

[Example]

To select memory channel 15, specify memory channel number data as 15H.

Decimal value	Corresponding BCD code	
	Binary code	Hexadecimal code
9	0000 1001	09H
10	0001 0000	10H
15	0001 0101	15H
26	0010 0110	26H
87	1000 0111	87H

Table 1-2

2-1 Pre-setting outline

WARNING: DISCONNECT the AC and DC power cables from the radios before performing any internal work.

Following is the pre-setting outline for the CI-V radios, CT-17 and your personal computer. Refer to Section 2-2-2-11 for condition setting. Refer to Section 3-1-3-4 for connection.

- 1) Set the baud rate, address and transceive function condition for all radios.
 - For some radios, these settings can be performed after power is turned ON.
- 2) Connect the [REMOTE] jack on each radio to the CT-17.
- 3) Connect the computer to the CT-17 using a suitable RS-232C straight cable.
- 4) Connect a 9-15 V DC power source to the CT-17.
- 5) Turn ON your radios and personal computer.
- 6) Set the personal computer conditions.

2-2 Changing CI-IV to CI-V

To control a CI-IV radio remotely with the CI-V System, an optional UX-14 CI-IV/CI-V CONVERTER **MUST** be installed. Refer to Table 2-1 below.

2-3 Baud rate for radios

■ For a CI-V radio

The Icom standard baud rate of 1200 bps is specified before shipping.

■ For a CI-IV radio

Specify a radio baud rate. Refer to the UX-14 instruction manual.

2-4 Baud rate modification

If required, modify the radio baud rate. Selectable baud rates and setting methods differ according to radios. Refer to the instruction manual of each radio or UX-14.

NOTE: Each radio's baud rate **MUST** be equal to the computer's baud rate. (Section 2-7)

	CI-IV System	CI-V System
HF transceivers	IC-751, IC-751A	IC-725, IC-726, IC-728, IC-729, IC-735, IC-737, IC-761, IC-765
Receivers	IC-R71A/E/D	IC-R72, IC-R7000, IC-R7100, IC-R9000
28/50 MHz transceivers	—	IC-575A/H
144 MHz transceivers	IC-271A/E/H	IC-275A/E/H
220 MHz transceiver	—	IC-375A
430 MHz transceivers	IC-471A/E/H	IC-475A/E/H
1200 MHz transceivers	IC-1271A/E	IC-1275A/E
Multi band transceiver	—	IC-970A/E/H

Table 2-1

2-5 Address number for each radio

To distinguish equipment, each radio has its own address in hexadecimal code.

■ For a CI-V radio

An Icom standard address number was specified before shipping. Refer to Table 2-2 below.

■ For a CI-IV radio

Specify an Icom standard address number. Refer to the UX-14 instruction manual and Table 2-2 below.

2-6 Address number modification

If required, up to 4 radios of the same model can be connected to the CT-17. However, a different address number **MUST** be specified for each radio.

Address numbers 01H-7FH are allocated, but the selectable range varies according to radios.

Setting methods differ according to radios. Refer to the instruction manual of each radio or the UX-14.

NOTE: DO NOT specify address number 00H, E0H or F0H-FFH for a radio address. These address numbers are already reserved for the controller and other functions.

2-7 Personal computer conditions

Specify RS-232C port conditions (protocol) on your computer as follows:

Baud rate	1200 bps
Data bit length	8 bits
Parity check	No parity
Start bit length	1 bit
Stop bit length	1 bit
System	Full duplex
X parameter	Non effective
S parameter	Non effective

Table 2-3

NOTE: The Icom standard baud rate of 1200 bps is specified for each radio before shipping. (Section 2-4)

2-8 Address number for the controller

Specify the controller's address in hexadecimal code.

The Icom standard address number for the controller is E0H.

Radio	Address	Radio	Address	Radio	Address	Radio	Address
IC-735	04H	IC-R71A/E/D	1AH	IC-725	28H	—	36H
IC-R7000	08H	IC-751A	1CH	IC-R9000	2AH	IC-728	38H
IC-275A/E/H	10H	IC-761	1EH	IC-765	2CH	IC-729	3AH
IC-375A	12H	IC-271A/E/H	20H	IC-970A/E/H	2EH	IC-737	3CH
IC-475A/E/H	14H	IC-471A/E/H	22H	IC-726	30H	—	3EH
IC-575A/H	16H	IC-1271A/E	24H	IC-R72	32H	—	40H
IC-1275A/E	18H	IC-781	26H	IC-R7100	34H	Controller	E0H

Table 2-2

— : Not yet assigned for any radio at the time of printing.

2-9 What is the transceive function?

When the transceive function is ON, any change in the operating frequency or mode on a radio is automatically transferred to other radios.

[Example]

In Fig. 2-1 below, when the operating frequency of the IC-735 is changed, the IC-R72 follows the IC-735. This is because the operating frequency range of the IC-735 corresponds to that of the IC-R72.

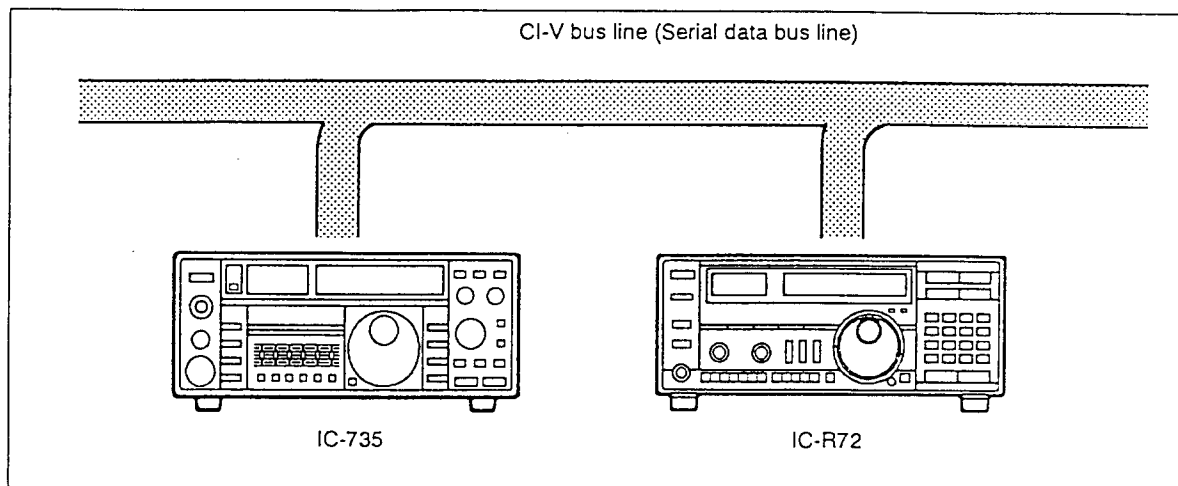

Fig. 2-1

2-10 Transceive function ON/OFF

The transceive function can be set as ON (effective), or OFF (non-effective), for each radio.

Setting methods differ according to radios. Refer to the instruction manual of each radio or the UX-14.

Transceive function ON (effective) was specified before shipping.

2-11 Operating frequency data length

Radios	Operating frequency data length
IC-735	4 bytes (fixed)
Other HF transceivers, IC-R71A/E/D, IC-R72, IC-R7100, IC-R9000	5 bytes *1 or 4 bytes *2
Other radios	5 bytes (fixed)

Table 2-5

*1: For these radios, the frequency data length was specified at 5 bytes before shipping.

*2: Specify the frequency data length at 4 bytes only for operating the transceive function with the IC-735. Setting methods differ according to radios. Refer to the instruction manual of each radio or the UX-14.

3-1 Connection outline

After performing internal settings for each radio, connect each radio, the CT-17 and your computer.

CAUTION: DISCONNECT the AC or DC power cable from each radio, the computer and the DC power supply for the CT-17 before connection.

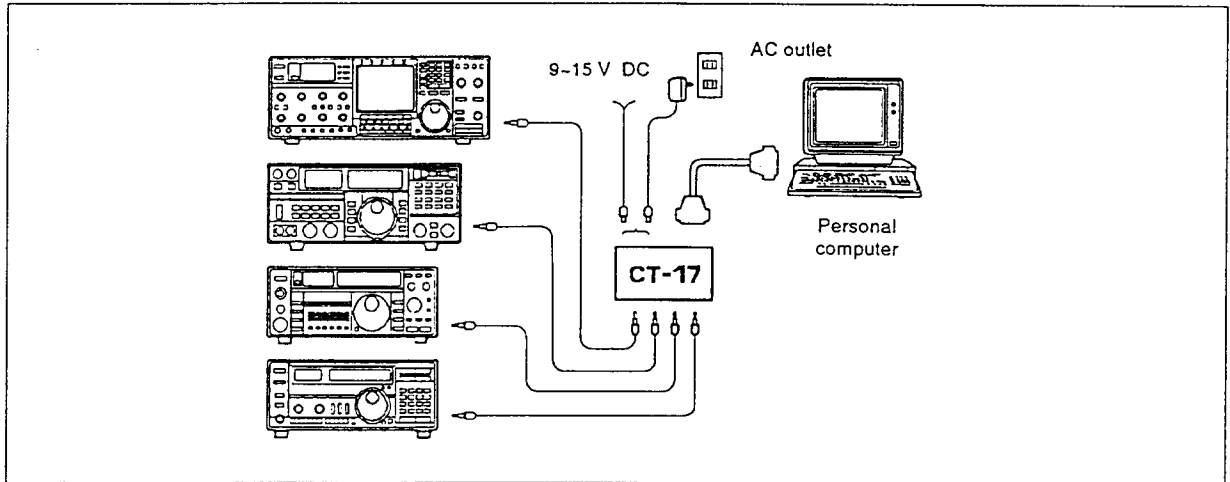

Fig. 3-1

3-2 RS-232C cable connection

According to the RS-232C socket on your computer, connect a suitable RS-232C cable.

■ For a 25-pin RS-232C socket

Connect the RS-232C connector on the CT-17 to your computer using the supplied OPC-159 RS-232C CABLE.

Inch-type screws are attached to the supplied RS-232C cable. If the RS-232C socket of your computer uses meter-type screws, the supplied meter-type screws **MUST** be used.

■ For a non 25-pin RS-232C socket

Use an RS-232C straight cable equipped with a suitable connector for your computer on one end and a 25-pin connector on the other end. Or, use a suitable RS-232C straight adapter between the supplied OPC-159 RS-232C CABLE and your computer.

This kind of RS-232C straight cable and adapter are commonly used to connect between a computer and modem or TNC (Terminal Node Controller) for packet radio. Consult your computer dealer.

NOTE: An RS-232C cross (reverse) cable or adapter **CANNOT** be used.

3-3 Mini-plug cable connection

Connect the [REMOTE] jack on the radio to either the [CI-V REMOTE] jacks on the CT-17 using the supplied OPC-017A MINI-PLUG CABLE.

- The CT-17 accepts up to 4 radios.
- To connect 3 or 4 radios, additional OPC-017A **MUST** be purchased.

3-4 DC power supply connection

After all other connections, connect a 9-15 V DC power source to the [9-15V DC IN] jack on the CT-17 using the supplied OPC-012 DC POWER CABLE.

- The power indicator on the CT-17 lights up in red.
- An optional BC-25U/E, BC-26E or BC-27 WALL CHARGER also can be used.

Polarity of the OPC-012 is as follows:

White: + Black: -

CONVENIENT: If a radio is equipped with an ACC connector, 13.8 V DC may be available from the connector. Refer to the radio's instruction manual.

Command		Operation	IC-735	IC-R7000	IC-575	IC-751	IC-271	IC-725
Sub	IC-275				IC-751A	IC-471	IC-726	
					IC-375A	IC-761	IC-1271	IC-728
					IC-475	IC-R71		IC-729
					IC-1275			
00	—	Transfers operating frequency data.	Yes*1	Yes	Yes	Yes	Yes	Yes
01	md pd	Transfers operating mode data.	Yes*2	Yes	Yes	Yes	Yes	Yes
02	—	Reads upper/lower frequency data.	Yes	Yes	Yes	Yes	Yes	Yes
03	—	Reads operating frequency data.	Yes*1	Yes	Yes	Yes	Yes	Yes
04	—	Reads operating mode data.	Yes*2	Yes	Yes	Yes	Yes	Yes
05	—	Writes operating frequency data.	Yes*1	Yes	Yes	Yes	Yes	Yes
06	md pd	Writes operating mode data.	Yes*2	Yes	Yes	Yes	Yes	Yes
07	—	Selects VFO mode.	Yes	—	Yes	Yes	Yes	Yes
	00	Selects VFO A.	Yes	—	Yes	—	—	Yes
	01	Selects VFO B.	Yes	—	Yes	—	—	Yes
	A0	VFO A = VFO B	—	—	—	—	—	Yes
08	—	Selects MEMORY mode.	Yes	Yes	Yes	Yes	Yes	Yes
	mc	Selects memory channel.	Yes	Yes	Yes	Yes	Yes	Yes
09	—	Memory write.	Yes	Yes	Yes	Yes	Yes	Yes
0A	—	Memory channel → VFO.	Yes	—	Yes	Yes	Yes	Yes
0B	—	Memory clear.	—	Yes	Yes	—	—	Yes
0C	—	Reads offset freq.	—	—	Yes	—	Yes	—
0D	—	Writes offset freq.	—	—	Yes	—	Yes	—
0E	00	Stops scan or stops window scan.	—	—	Yes	—	—	Yes
	01	Programmed scan or memory scan starts.	—	—	Yes	—	—	Yes
0F	00	Cancel split frequency operation.	—	—	—	—	—	Yes
	01	Selects split frequency operation.	—	—	—	—	—	Yes

*1: Only for the IC-735, frequency data length is 4 bytes. For other radios, frequency data length is 5 bytes. Refer to Sections 2-10 and 2-11.

*2: The IC-735 CANNOT accept mode data with IF passband width data.

Table 4-1

Command		Operation	IC-781	IC-R9000	IC-765	IC-970	IC-R72	IC-R7100	IC-737
	Sub								
00	—	Transfers operating frequency data.	Yes	Yes	Yes	Yes	Yes	Yes	Yes
01	md : pd	Transfers operating mode data.	Yes	Yes	Yes	Yes	Yes	Yes	Yes
02	—	Reads upper/lower frequency data.	Yes	Yes	Yes	Yes	Yes	Yes	Yes
03	—	Reads operating frequency data.	Yes	Yes	Yes	Yes	Yes	Yes	Yes
04	—	Reads operating mode data.	Yes	Yes	Yes	Yes	Yes	Yes	Yes
05	—	Writes operating frequency data.	Yes	Yes	Yes	Yes	Yes	Yes	Yes
06	md : pd	Writes operating mode data.	Yes	Yes	Yes	Yes	Yes	Yes	Yes
07	—	Selects VFO mode.	Yes	—	Yes	Yes	Yes	—	Yes
	00	Selects VFO A.	Yes	—	Yes	Yes	—	—	Yes
	01	Selects VFO B.	Yes	—	Yes	Yes	—	—	Yes
	A0	VFO A = VFO B.	Yes	—	Yes	Yes	—	—	Yes
	B0	VFO A ↔ VFO B. *1	Yes	—	—	Yes	—	—	—
	C0	Turns dual watch OFF.	Yes	—	—	—	—	—	—
	C1	Turns dual watch ON.	Yes	—	—	—	—	—	—
	D0	Accesses MAIN band.	—	—	—	Yes	—	—	—
	D1	Accesses SUB band.	—	—	—	Yes	—	—	—
E0	wn	Selects the front window.	—	—	—	—	—	Yes	—
08	—	Selects MEMORY mode.	Yes	Yes	Yes	Yes	Yes	Yes	Yes
	mc	Selects memory channel.	Yes	Yes	Yes	Yes	Yes	Yes	Yes
09	—	Memory write.	Yes	Yes	Yes	Yes	Yes	Yes	Yes
0A	—	Memory channel → VFO.	Yes	—	Yes	Yes	Yes	—	Yes
0B	—	Memory clear.	Yes	Yes	Yes	Yes	Yes	—	—
0C	—	Reads offset freq.	—	—	—	Yes	—	—	—
0D	—	Writes offset freq.	—	—	—	Yes	—	—	—
0E	00	Stops scan or stops window scan.	Yes	Yes	Yes	Yes	Yes	Yes**2	Yes
	01	Programmed scan or memory scan starts.	Yes	—	Yes	Yes	Yes	—	Yes
	02	Programmed scan starts.	Yes	Yes	—	—	Yes	Yes**2	—
	03	Δf scan starts.	Yes	Yes	—	—	—	—	—
	04	Auto memory write scan starts.	—	Yes	—	—	Yes	Yes**2	—
	12	Fine programmed scan starts.	Yes	—	—	—	—	—	—
	13	Fine Δf scan starts.	Yes	—	—	—	—	—	—
	22	Memory scan starts.	Yes	Yes	—	—	Yes	Yes**2	—
	23	Selected number memory scan starts.	Yes	Yes	—	—	Yes	Yes**2	—
	24	Selected mode memory scan starts.	—	Yes	—	—	—	Yes**2	—
	42	Priority scan or window scan starts.	—	Priority	—	—	—	Window**2	—
	A0	Unfixes the center frequency for Δf scan.	Yes	Yes	—	—	—	—	—
	AA	Fixes the center frequency for Δf scan.	Yes	Yes	—	—	—	—	—
	A1	Sets Δf frequency width of ± 2.5 kHz.	Yes	Yes	—	—	—	—	—
	A2	Sets Δf frequency width of ± 5 kHz.	Yes	Yes	—	—	—	—	—
A3	Sets Δf frequency width of ± 10 kHz.	Yes	Yes	—	—	—	—	—	
A4	Sets Δf frequency width of ± 20 kHz.	Yes	Yes	—	—	—	—	—	
A5	Sets Δf frequency width of ± 50 kHz.	Yes	Yes	—	—	—	—	—	

*1: For the IC-970, MAIN ↔ SUB.

*2: For advanced window scan, a window number MUST be specified after the sub command. Refer to Section 7-13.

Table 4-2

Command		Operation	IC-781	IC-R9000	IC-765	IC-970	IC-R72	IC-R7100	IC-737
	Sub								
0E	B0	Sets the selected number as non effective for a memory channel.	Yes	Yes	—	—	Yes	Yes	—
	B1	Sets the selected number as effective for a memory channel.	Yes	Yes	—	—	Yes	Yes	—
	B2	Sets the scan number for a selected number memory scan.	Yes	Yes	—	—	—	Yes*	—
	C0	Turns the VSC function OFF.	—	Yes	—	—	—	Yes	—
	C1	Turns the VSC function ON.	—	Yes	—	—	—	Yes	—
	D0	Selects scan resume condition [∞].**	—	Yes	—	—	—	Yes	—
	D1	Selects scan resume condition [OFF].**	—	Yes	—	—	—	Yes	—
	D2	Selects scan resume condition [B].**	—	Yes	—	—	—	—	—
0F	00	Cancels split frequency operation.	Yes	—	Yes	Yes	—	—	Yes
	01	Selects split frequency operation.	Yes	—	Yes	Yes	—	—	Yes
	10	Cancels duplex operation.	—	—	—	Yes	—	—	—
	11	Selects - duplex operation.	—	—	—	Yes	—	—	—
	12	Selects +duplex operation.	—	—	—	Yes	—	—	—
	10	00	Selects the minimum tuning step.	—	10 Hz	—	—	10 Hz	100 Hz
01		Selects tuning step 1.	—	100 Hz	—	—	1 kHz	1 kHz	1 kHz
02		Selects tuning step 2.	—	1 kHz	—	—	2 kHz	5 kHz	2 kHz
03		Selects tuning step 3.	—	5 kHz	—	—	3 kHz	10 kHz	3 kHz
04		Selects tuning step 4.	—	9 kHz	—	—	4 kHz	12.5 kHz	4 kHz
05		Selects tuning step 5.	—	10 kHz	—	—	5 kHz	20 kHz	5 kHz
06		Selects tuning step 6.	—	12.5 kHz	—	—	6 kHz	25 kHz	6 kHz
07		Selects tuning step 7.	—	20 kHz	—	—	7 kHz	100 kHz	7 kHz
08		Selects tuning step 8.	—	25 kHz	—	—	8 kHz	—	8 kHz
09		Selects tuning step 9.	—	100 kHz	—	—	9 kHz	—	9 kHz
10		Selects tuning step 10.	—	—	—	—	10 kHz	—	10 kHz
11	00	Attenuator OFF.	—	Yes	—	—	—	Yes	—
	10	Selects a 10 dB attenuator.	—	Yes	—	—	—	—	—
	20	Selects a 20 dB attenuator.	—	Yes	—	—	—	Yes	—
	30	Selects a 30 dB attenuator.	—	Yes	—	—	—	—	—
12	00	Turns the antenna input OFF.**	—	Yes	—	—	—	—	Yes
	01	Turns the antenna input ON.**	—	Yes	—	—	—	—	Yes
13	00	Announces all data.**	—	Yes	—	—	Yes	Yes	—
	01	Announces frequency data only.**	—	Yes	—	—	Yes	Yes	—
14	sc : gd	Selects the AF, RF gain and squelch.**	—	Yes	—	—	—	Yes	—
15	01	Reads out squelch status.	—	Yes	—	—	Yes	Yes	—
	02	Reads out signal strength.	—	Yes	—	—	—	Yes	—

*1: For advanced window scan, a window number MUST be specified after the sub command. Refer to Section 2-10.

*2: Refer to the IC-R9000 instruction manual p. 46 or the IC-R7100 instruction manual p. 22 for details.

*3: For the IC-737, selects the [ANT 1] connector.

*4: For the IC-737, selects the [ANT 2] connector.

*5: An optional UT-36 is required.

*6: For the IC-R7100, only AF gain level can be controlled via the CI-V System.

Table 4-3

5-1 Basic message format

■ Controller → radio (command message)

The controller transmits a command message to a radio in the following data format.

The data format differs according to command numbers. A data area is added for some commands.

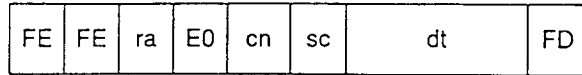

→ Sent left to right.

FE **Preamble code**
FEH must be transmitted 2 times for data synchronization.

ra **Receive address**
Specify a radio's address in hexadecimal code. (Section 2-5)

E0 **Transmit address**
Specify the controller's address, E0H. (Section 2-8)

cn **Command number**
Specify a command number in hexadecimal code. (Section 4)

sc **Sub command number**
For some commands, a sub command number **MUST** be specified in hexadecimal code. (Section 4)

dt **Data area**
For some commands, additional data **MUST** be specified in BCD code. (Section 1-10)

For some commands, a data area is not to be added.

FD **End of message code**
Specify FDH at the end of the message.

■ Radio → controller

When a command message is received, the radio transmits the data message, the OK message or NG message.

(1) Data message

When the controller requests sending of the operating frequency data, operating mode data, etc., the radio transmits the requested data in the following data format.

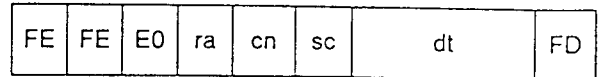

→ Sent left to right.

FE **Preamble code**
The radio automatically specifies FEH 2 times for data synchronization.

E0 **Receive address**
The radio automatically specifies the controller's address, E0H.

ra **Transmit address**
The radio automatically specifies its address in hexadecimal code.

cn **Command number**
The radio automatically specifies the received command number in hexadecimal code.

sc **Sub command number**
The radio automatically specifies the received sub command number in hexadecimal code.

dt **Data area**
The radio sends back requested data for the following commands in BCD code. (Section 1-10)

Command 02H (Section 7-2)

Command 03H (Section 7-3)

Command 04H (Section 7-3)

Command 0CH (Section 7-8)

Command 15H (Section 7-16)

FD **End of message code**
The radio automatically specifies FDH at the end of the message.

(2) OK message

The OK message means that the radio has received a correct command message from the controller and has performed the specified operation.

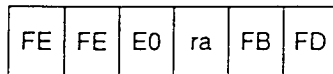

→ Sent left to right.

FE **Preamble code**
The radio automatically specifies FEH 2 times for data synchronization.

E0 **Receive address**
The radio automatically specifies the controller's address, E0H.

ra **Transmit address**
The radio automatically specifies its address in hexadecimal code.

FB **OK code**
The radio automatically specifies the OK code, FBH.

FD **End of message code**
The radio automatically specifies FDH at the end of the message.

Under the following condition, the radio does not transmit the OK message even when the correct command message has been received:

- Command 00H or 01H has been received. (Sections 2-9, 7-1)
- When the radio has transmitted requested data.

(3) NG message

The NG message means that the radio has received a message, but it could not perform the specified operation.

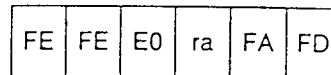

→ Sent left to right.

FE **Preamble code**
The radio automatically specifies FEH 2 times for data synchronization.

E0 **Receive address**
The radio automatically specifies the controller's address, E0H.

ra **Transmit address**
The radio automatically specifies its address in hexadecimal code.

FA **NG code**
The radio automatically specifies the NG code, FAH.

FD **End of message code**
The radio automatically specifies FDH at the end of the message.

Under the following conditions, the radio transmits the NG message:

- Command 00H or 01H has been received. (Sections 2-9, 7-1)
- Undefined command or sub command is received.
- Specified frequency range or mode does not correspond to the radio's operating frequency range or mode.
- The radio is not equipped with the specified function.
- The radio is not equipped with the specified memory channel.
- A blank channel has been specified for command message 0AH. (Section 7-7)

5-2 Frequency data format

For command 00H, 02H or 05H, specify frequency data according to the following format. For command 02H or 03H, each transceiver transmits according to the same format.

The operating frequency data length is 5 bytes* and each byte is specified in BCD code. (Section 1-10)

*For the IC-735, 4 bytes.

■ Frequency data length

IC-735 only	4 bytes. Specify the 10 MHz-1 Hz digits.
Other radios	5 bytes. Specify the 1 GHz-1 Hz digits. Only for transceive operation with the IC-735, select 4 bytes, and specify the 10 MHz-1 Hz digits.

Table 5-1

Some radios may not display the 10 Hz and 1 Hz digits.

Each radio ignores the frequency data below the minimum tuning step.

[Example]

When the operating frequency is 145.123450 MHz, the 1st byte, 50H refers to the 10 Hz and 1 Hz digits. The 2nd byte, 34H refers to the 1 kHz and 100 Hz digits.

For the IC-735, the 5th byte **CANNOT** be specified.

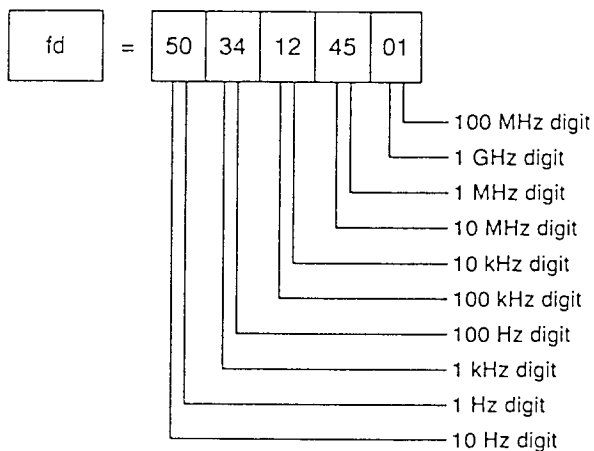
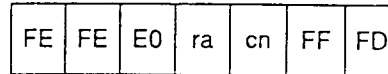

Fig. 5-1

5-3 Memory blank code

A memory channel without contents is called a blank channel. When a blank channel is specified via the controller with command 03H, 04H or 0CH, the radio transmits the blank code, FFH.

■ Radio → controller



→ Sent left to right.

The IC-761 or other radios equipped with the CI-IV System transmit previous memory contents, even though the memory channel is a blank channel. This is because blank channels have previous contents.

5-4 Jammer code

The jammer code, FCH, prevents a message collision among radios and the controller. (Section 1-6)

■ Message transmitting radio

During message transmission, a radio which is transmitting receives a transmitted message from itself to detect a message collision.

If a message collision with another radio is detected, the radio halts message transmission, and checks that no other messages are transmitted on the CI-V bus line.

When no other message is transmitted, the radio transmits the jammer code, FCH, 5 times as below.



→ Sent left to right.

After jammer code transmission, the radio checks that no other message is being transmitted on the CI-V bus line, and transmits the previous message again.

■ Message receiving radio

When the jammer code, FCH, is received during command message receiving, the radio cancels the current command message and waits for the next command message.

5-5 Preamble code

From the controller, FEH **MUST** be transmitted 2 times at the beginning of the message for data synchronization.

Each radio automatically transmits FEH 2 times at the beginning of the message for data synchronization.

5-6 End of message code

From the controller, FDH **MUST** be transmitted at the end of the message.

Each radio automatically transmits FDH at the end of message.

6-1 What are special memory channel numbers?

Some radios have special memory channel numbers to specify a call channel, scan edge channels etc.

By specifying a special memory channel number, a call channel or scan edge channel can be specified in the same way as ordinary memory channels. (Section 7-7)

6-2 Scan edge channels for the IC-R9000

Group 0	0P1	1000	Group 5	5P1	1010
	0P2	1001		5P2	1011
Group 1	1P1	1002	Group 6	6P1	1012
	1P2	1003		6P2	1013
Group 2	2P1	1004	Group 7	7P1	1014
	2P2	1005		7P2	1015
Group 3	3P1	1006	Group 8	8P1	1016
	3P2	1007		8P2	1017
Group 4	4P1	1008	Group 9	9P1	1018
	4P2	1009		9P2	1019

Table 6-1

6-3 Scan edge channels for the IC-R7100

Group 0	0P1	0900	Group 5	5P1	0910
	0P2	0901		5P2	0911
Group 1	1P1	0902	Group 6	6P1	0912
	1P2	0903		6P2	0913
Group 2	2P1	0904	Group 7	7P1	0914
	2P2	0905		7P2	0915
Group 3	3P1	0906	Group 8	8P1	0916
	3P2	0907		8P2	0917
Group 4	4P1	0908	Group 9	9P1	0918
	4P2	0909		9P2	0919

Table 6-2

6-4 Other special memory channel numbers

	Scan edge		Call channel
	P1	P2	
IC-725, IC-726, IC-737, IC-761, IC-765, IC-781, IC-575A/H, IC-R72	0100	0101	—
IC-275A/E/H, IC-375A, IC-475A/E/H, IC-1275A/E, IC-970A/E/H*	0100	0101	0102

Table 6-3

*For the IC-970A/E/H, the call channel and scan edge channels P1 and P2 in the selected band are accessible.

	Scan edge		Call channel
	25	26	
IC-728, IC-729	0025	0026	—

Table 6-4

6-5 Special memory channel access example

For the IC-R9000, to recall scan edge channel 9P2, send command 08H in the data format below.

FE	FE	2A	E0	2A	10	19	FD
----	----	----	----	----	----	----	----

- 2A** Receive address
Specify the IC-R9000's address, 2AH.
- E0** Transmit address
Specify the controller's address, E0H.
- 08** Command number
Specify a command number, 08H, for memory channel recall. (Section 7-7)
- 10** Special memory channel number
Specify special memory channel number 1019 in BCD code to recall scan edge channel 9P2 in the IC-R9000. (Section 1-10)
- 19**

6-6 Mode and IF passband width tables

	Mode data
LSB	00
USB	01
AM	02
CW	03
RTTY (FSK)	04
FM	05
Wide FM	06
SSB*	0500

Table 6-5

*For the IC-R7000 only.

For the IC-781, IC-R9000 and IC-R7000, IF passband width is selectable via the CI-V System. Other radios are not equipped with this capability.

	Mode	Mode data	IF passband width data		
			Wide	Medium	Narrow
IC-781	LSB	00	01	—	02
	USB	01	01	—	02
	AM	02	01	—	02
	CW	03	01	—	02
	RTTY	04	01	—	02
	FM	05	01	—	02
IC-R9000	LSB	00	01	02	03
	USB	01	01	02	03
	AM	02	01	02	03
	CW	03	01	02	03
	RTTY	04	01	02	03
	FM	05	01	02	03
	Wide-FM	06	01*	02*	03*
IC-R7000	SSB	0500	Fixed		
	AM	02	Fixed		
	FM	05	01	—	02

Table 6-6

* IF passband width is fixed even though the IC-R9000 accepts IF passband width data for wide-FM mode.

7-1 Transceive commands

Command 00H Transfers operating frequency data. No response from any radio.

Radio ↔ radio

This command is used to transfer operating frequency data automatically among several radios. (Section 2-9)

When the operating frequency is changed on a radio, the radio automatically transfers the operating frequency data to other radios. No manual operation is required.

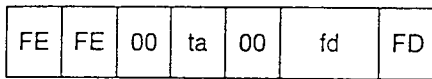

00 **Receive address**
When the operating frequency is changed on a radio, the radio automatically selects the receive address, 00H.

ta **Transmit address**
The radio automatically specifies its address.

00 **Command number**
The radio automatically specifies the command number; 00H.

fd **Operating frequency data**
The radio automatically transmits its operating frequency data in BCD code. (Section 1-10)

[Example] When operating frequency data is 145.123450 MHz.

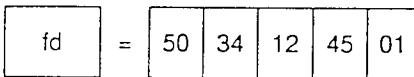

NOTE: If the transceive function is OFF, the radio does not transfer or receive the operating frequency data from other radios. (Section 2-10)

Each radio that is connected on the same CI-V bus line receives the operating frequency data. As long as the received frequency data is within its operating frequency range, each radio accepts the data and changes the displayed operating frequency.

Unlike command 05H, no radio transmits an OK or NG code even when this command is received.

Controller → radio

This command also can be used to transfer operating frequency data from the controller to several radios simultaneously or only to a specified radio.

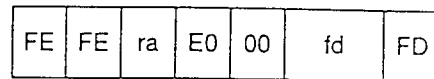

ra **Receive address**
Specify the receive address as below:
00H for radios with the transceive function is ON. (Section 2-10)
A radio address only for a specified radio. (Section 2-5)

E0 **Transmit address**
Specify the controller's address, E0H.

00 **Command number**
Specify the command number, 00H.

fd **Operating frequency data**
Specify operating frequency data in BCD code as in the example at left. (Sections 1-10, 5-2)

NOTE: Each radio that is connected on the same CI-V bus line receives the operating frequency data as below:

When the receive address 00H is specified, radios with the transceive function ON receive the data.
When the receive address is not 00H, only the specified radio receives the data.

If the transceive function is OFF, the radio does not receive command 00H with the receive address 00H, and receives only a command with the radio's address.

Unlike command 05H, no radio transmits an OK or NG code even when this command is received.

Command 01H	Transfers operating mode data. No response from any radio.																
<div style="margin-bottom: 10px;"> <p>■ Radio ↔ radio</p> <p>This command is used to transfer operating mode data automatically among several radios. (Section 2-9)</p> <p>When the operating mode is changed on a radio, the radio automatically transfers the operating mode data to other radios. No manual operation is required.</p> </div> <table border="1" style="width: 100%; text-align: center; border-collapse: collapse; margin-bottom: 10px;"> <tr> <td style="padding: 2px 5px;">FE</td> <td style="padding: 2px 5px;">FE</td> <td style="padding: 2px 5px;">00</td> <td style="padding: 2px 5px;">ta</td> <td style="padding: 2px 5px;">01</td> <td style="padding: 2px 5px;">md</td> <td style="padding: 2px 5px;">pd</td> <td style="padding: 2px 5px;">FD</td> </tr> </table> <div style="margin-bottom: 10px;"> <p>00 Receive address When the operating mode is changed on a radio, the radio automatically specifies the receive address, 00H.</p> </div> <div style="margin-bottom: 10px;"> <p>ta Transmit address The radio automatically specifies its address.</p> </div> <div style="margin-bottom: 10px;"> <p>01 Command number The radio automatically specifies the command number, 01H.</p> </div> <div style="margin-bottom: 10px;"> <p>md Operating mode data The radio automatically transmits its operating mode data in BCD code. (Sections 1-10, 6-6)</p> </div> <div style="margin-bottom: 10px;"> <p>pd IF passband width data If the radio is equipped with IF passband width selection capability via the CI-V System, when IF passband width is changed, the radio transmits the data in BCD code. (Sections 1-10, 6-6)</p> </div> <p>NOTE: If the function is OFF, the radio does not transfer or receive the operating mode data with other radios. (Section 2-10)</p> <p>Each radio that is connected on the same CI-V bus line receives the operating mode and IF passband width data.</p> <p>Unlike command 06H, no radio transmits an OK or NG code even when this command is received.</p>	FE	FE	00	ta	01	md	pd	FD	<div style="margin-bottom: 10px;"> <p>■ Controller → radio</p> <p>This command also can be used to transfer operating frequency data from the controller to several radios simultaneously or only to a specified radio.</p> </div> <table border="1" style="width: 100%; text-align: center; border-collapse: collapse; margin-bottom: 10px;"> <tr> <td style="padding: 2px 5px;">FE</td> <td style="padding: 2px 5px;">FE</td> <td style="padding: 2px 5px;">ra</td> <td style="padding: 2px 5px;">E0</td> <td style="padding: 2px 5px;">01</td> <td style="padding: 2px 5px;">md</td> <td style="padding: 2px 5px;">pd</td> <td style="padding: 2px 5px;">FD</td> </tr> </table> <div style="margin-bottom: 10px;"> <p>ra Receive address Specify receive address as below: 00H for radios with the transceive function is ON. (Section 2-10) A radio address for only a specified radio. (Section 2-5)</p> </div> <div style="margin-bottom: 10px;"> <p>E0 Transmit address Specify the controller's address, E0H.</p> </div> <div style="margin-bottom: 10px;"> <p>01 Command number Specify the command number, 01H.</p> </div> <div style="margin-bottom: 10px;"> <p>md Operating mode data Specify operating mode data. (Section 6-6)</p> </div> <div style="margin-bottom: 10px;"> <p>pd IF passband width data If the radio is equipped with IF passband width selection capability via the CI-V System, this data can be specified. (Section 6-6)</p> </div> <p>NOTE: Each radio that is connected on the same CI-V bus line receives the operating mode and IF passband width data as below: When the receive address 00H is specified, radios with the transceive function ON receive the data. When the receive address is not 00H, only the specified radio receives the data.</p> <p>If the transceive function is OFF, the radio does not receive command 01H with the receive address 00H and receives only a command with the radio's address.</p> <p>Unlike command 06H, no radio transmits an OK or NG code even when this command is received.</p>	FE	FE	ra	E0	01	md	pd	FD
FE	FE	00	ta	01	md	pd	FD										
FE	FE	ra	E0	01	md	pd	FD										

7-2 Upper/lower-edge frequency readout command

Command 02H	Reads out upper/lower-edge frequency data.
---------------------------	--

■ Controller → radio

FE	FE	ra	E0	02	FD
----	----	----	----	----	----

ra **Receive address**
Specify a radio's address. (Section 2-5)

E0 **Transmit address**
Specify the controller's address, E0H.

02 **Command number**
Specify the command number, 02H.

■ Radio → controller

FE	FE	E0	ra	02	le	2D	he	FD
----	----	----	----	----	----	----	----	----

E0 **Receive address**
The radio automatically specifies the controller's address, E0H.

ra **Transmit address**
The radio automatically specifies its address.

02 **Command number**
The radio automatically specifies the received command number, 02H.

le **Lower-edge frequency data**
The radio sends back lower-edge frequency data in BCD code. (Sections 1-10, 5-2)

2D **Separator code**
To punctuate the space between the lower-edge and higher-edge frequency data, the radio sends back a separator, 2DH.

he **Higher-edge frequency data**
The radio sends back higher-edge frequency data in BCD code. (Sections 1-10, 5-2)

[Example] When the lower-edge frequency is 144.000000 MHz and higher-edge frequency is 146.000000 MHz.

le	=	00	00	00	44	01
he	=	00	00	00	46	01

NOTE: Depending on the radio's condition, the arrangement of lower and higher-edge frequency data may be reversed.

If the radio is equipped with scan edge channels P1 and P2, the radio transmits these channel contents. If the radio is not equipped with scan edge channels, the radio transmits its highest and lowest band edge frequencies.

7-3 Operating frequency, mode readout commands

Command 03H	Reads out operating frequency data.													
<p>■ Controller → radio</p> <table border="1" style="width: 100%; text-align: center; border-collapse: collapse;"> <tr> <td style="width: 12.5%;">FE</td> <td style="width: 12.5%;">FE</td> <td style="width: 12.5%;">ra</td> <td style="width: 12.5%;">E0</td> <td style="width: 12.5%;">03</td> <td style="width: 12.5%;">FD</td> </tr> </table> <p>ra Receive address Specify a radio's address. (Section 2-5)</p> <p>E0 Transmit address Specify the controller's address, E0H.</p> <p>03 Command number Specify the command number, 03H.</p> <p>NOTE: If a blank channel is selected, the radio sends back the memory blank code, FFH, except for the IC-761 and CI-IV radios. (Section 5-3)</p>	FE	FE	ra	E0	03	FD	<p>■ Radio → controller</p> <table border="1" style="width: 100%; text-align: center; border-collapse: collapse;"> <tr> <td style="width: 12.5%;">FE</td> <td style="width: 12.5%;">FE</td> <td style="width: 12.5%;">E0</td> <td style="width: 12.5%;">ra</td> <td style="width: 12.5%;">03</td> <td style="width: 12.5%;">fd</td> <td style="width: 12.5%;">FD</td> </tr> </table> <p>E0 Receive address The radio automatically specifies the controller's address, E0H.</p> <p>ra Transmit address The radio automatically specifies its address.</p> <p>03 Command number The radio automatically specifies the received command number, 03H.</p> <p>fd Operating frequency data The radio sends back operating frequency data in BCD code. (Sections 1-10, 5-2)</p>	FE	FE	E0	ra	03	fd	FD
FE	FE	ra	E0	03	FD									
FE	FE	E0	ra	03	fd	FD								

Command 04H	Reads out the operating mode and IF passband width data.														
<p>■ Controller → radio</p> <table border="1" style="width: 100%; text-align: center; border-collapse: collapse;"> <tr> <td style="width: 12.5%;">FE</td> <td style="width: 12.5%;">FE</td> <td style="width: 12.5%;">ra</td> <td style="width: 12.5%;">E0</td> <td style="width: 12.5%;">04</td> <td style="width: 12.5%;">FD</td> </tr> </table> <p>ra Receive address Specify a radio's address. (Section 2-5)</p> <p>E0 Transmit address Specify the controller's address, E0H.</p> <p>04 Command number Specify the command number, 04H.</p> <p>NOTE: If a blank channel is selected, the radio sends back the memory blank code, FFH, except for the IC-761 and CI-IV radios. (Section 5-3)</p>	FE	FE	ra	E0	04	FD	<p>■ Radio → controller</p> <table border="1" style="width: 100%; text-align: center; border-collapse: collapse;"> <tr> <td style="width: 12.5%;">FE</td> <td style="width: 12.5%;">FE</td> <td style="width: 12.5%;">E0</td> <td style="width: 12.5%;">ra</td> <td style="width: 12.5%;">04</td> <td style="width: 12.5%;">md</td> <td style="width: 12.5%;">pd</td> <td style="width: 12.5%;">FD</td> </tr> </table> <p>E0 Receive address The radio automatically specifies the controller's address, E0H.</p> <p>ra Transmit address The radio automatically specifies its address.</p> <p>04 Command number The radio automatically specifies the received command number, 04H.</p> <p>md Operating mode data The radio sends back operating mode data.</p> <p>pd IF passband width data The radio may send back IF passband width data. (Section 6-6)</p>	FE	FE	E0	ra	04	md	pd	FD
FE	FE	ra	E0	04	FD										
FE	FE	E0	ra	04	md	pd	FD								

7-4 Operating frequency, mode writing commands

Command 05H	Writes operating frequency data into a displayed VFO or memory channel.													
■ Controller → radio	■ Radio → controller													
<table border="1" style="display: inline-table; border-collapse: collapse;"> <tr> <td style="padding: 2px 5px;">FE</td> <td style="padding: 2px 5px;">FE</td> <td style="padding: 2px 5px;">ra</td> <td style="padding: 2px 5px;">E0</td> <td style="padding: 2px 5px;">05</td> <td style="padding: 2px 5px;">fd</td> <td style="padding: 2px 5px;">FD</td> </tr> </table>	FE	FE	ra	E0	05	fd	FD	<table border="1" style="display: inline-table; border-collapse: collapse;"> <tr> <td style="padding: 2px 5px;">FE</td> <td style="padding: 2px 5px;">FE</td> <td style="padding: 2px 5px;">E0</td> <td style="padding: 2px 5px;">ra</td> <td style="padding: 2px 5px;">FB or FA</td> <td style="padding: 2px 5px;">FD</td> </tr> </table>	FE	FE	E0	ra	FB or FA	FD
FE	FE	ra	E0	05	fd	FD								
FE	FE	E0	ra	FB or FA	FD									
<table border="1" style="display: inline-table; border-collapse: collapse;"> <tr> <td style="padding: 2px 5px;">ra</td> <td style="padding: 5px;">Receive address</td> </tr> </table> <p style="margin-left: 20px;">Specify a radio's address. (Section 2-5)</p>	ra	Receive address	<table border="1" style="display: inline-table; border-collapse: collapse;"> <tr> <td style="padding: 2px 5px;">FB</td> <td style="padding: 5px;">OK code</td> </tr> </table> <p style="margin-left: 20px;">When the correct command is received, the radio operates as follows.</p> <p style="margin-left: 40px;">Selects the specified operating frequency for the displayed VFO or memory channel.</p> <p style="margin-left: 40px;">Sends back the OK code, FBH.</p>	FB	OK code									
ra	Receive address													
FB	OK code													
<table border="1" style="display: inline-table; border-collapse: collapse;"> <tr> <td style="padding: 2px 5px;">E0</td> <td style="padding: 5px;">Transmit address</td> </tr> </table> <p style="margin-left: 20px;">Specify the controller's address, E0H.</p>	E0	Transmit address	<table border="1" style="display: inline-table; border-collapse: collapse;"> <tr> <td style="padding: 2px 5px;">FA</td> <td style="padding: 5px;">NG code</td> </tr> </table> <p style="margin-left: 20px;">If the specified frequency range does not correspond to the radio's operating frequency range, the radio sends back the NG code, FAH.</p>	FA	NG code									
E0	Transmit address													
FA	NG code													
<table border="1" style="display: inline-table; border-collapse: collapse;"> <tr> <td style="padding: 2px 5px;">05</td> <td style="padding: 5px;">Command number</td> </tr> </table> <p style="margin-left: 20px;">Specify the command number, 05H.</p>	05	Command number												
05	Command number													
<table border="1" style="display: inline-table; border-collapse: collapse;"> <tr> <td style="padding: 2px 5px;">fd</td> <td style="padding: 5px;">Operating frequency data</td> </tr> </table> <p style="margin-left: 20px;">Specify operating frequency data in BCD code. (Section 1-10)</p>	fd	Operating frequency data												
fd	Operating frequency data													
<p>[Example] When the specified operating frequency data is 145.123450 MHz.</p>														
<table border="1" style="display: inline-table; border-collapse: collapse;"> <tr> <td style="padding: 2px 5px;">fd</td> <td style="padding: 5px;">=</td> <td style="padding: 2px 5px;">50</td> <td style="padding: 2px 5px;">34</td> <td style="padding: 2px 5px;">12</td> <td style="padding: 2px 5px;">45</td> <td style="padding: 2px 5px;">01</td> </tr> </table>		fd	=	50	34	12	45	01						
fd	=	50	34	12	45	01								

Command 06H	Writes operating mode data into a displayed VFO or memory channel.														
■ Controller → radio	■ Radio → controller														
<table border="1" style="display: inline-table; border-collapse: collapse;"> <tr> <td style="padding: 2px 5px;">FE</td> <td style="padding: 2px 5px;">FE</td> <td style="padding: 2px 5px;">ra</td> <td style="padding: 2px 5px;">E0</td> <td style="padding: 2px 5px;">06</td> <td style="padding: 2px 5px;">md</td> <td style="padding: 2px 5px;">pd</td> <td style="padding: 2px 5px;">FD</td> </tr> </table>	FE	FE	ra	E0	06	md	pd	FD	<table border="1" style="display: inline-table; border-collapse: collapse;"> <tr> <td style="padding: 2px 5px;">FE</td> <td style="padding: 2px 5px;">FE</td> <td style="padding: 2px 5px;">E0</td> <td style="padding: 2px 5px;">ra</td> <td style="padding: 2px 5px;">FB or FA</td> <td style="padding: 2px 5px;">FD</td> </tr> </table>	FE	FE	E0	ra	FB or FA	FD
FE	FE	ra	E0	06	md	pd	FD								
FE	FE	E0	ra	FB or FA	FD										
<table border="1" style="display: inline-table; border-collapse: collapse;"> <tr> <td style="padding: 2px 5px;">ra</td> <td style="padding: 5px;">Receive address</td> </tr> </table> <p style="margin-left: 20px;">Specify a radio's address. (Section 2-5)</p>	ra	Receive address	<table border="1" style="display: inline-table; border-collapse: collapse;"> <tr> <td style="padding: 2px 5px;">FB</td> <td style="padding: 5px;">OK code</td> </tr> </table> <p style="margin-left: 20px;">When the correct command is received, the radio operates as follows.</p> <p style="margin-left: 40px;">Selects the specified operating mode for the displayed VFO or memory channel.</p> <p style="margin-left: 40px;">Sends back the OK code, FBH.</p>	FB	OK code										
ra	Receive address														
FB	OK code														
<table border="1" style="display: inline-table; border-collapse: collapse;"> <tr> <td style="padding: 2px 5px;">E0</td> <td style="padding: 5px;">Transmit address</td> </tr> </table> <p style="margin-left: 20px;">Specify the controller's address, E0H.</p>	E0	Transmit address	<table border="1" style="display: inline-table; border-collapse: collapse;"> <tr> <td style="padding: 2px 5px;">FA</td> <td style="padding: 5px;">NG code</td> </tr> </table> <p style="margin-left: 20px;">Under the following conditions, the radio sends back the NG code, FAH.</p> <p style="margin-left: 40px;">The transceiver is not equipped with the specified mode.</p> <p style="margin-left: 40px;">The radio is not equipped with IF passband width selection capability with the CI-V System.</p>	FA	NG code										
E0	Transmit address														
FA	NG code														
<table border="1" style="display: inline-table; border-collapse: collapse;"> <tr> <td style="padding: 2px 5px;">06</td> <td style="padding: 5px;">Command number</td> </tr> </table> <p style="margin-left: 20px;">Specify the command number, 06H.</p>	06	Command number													
06	Command number														
<table border="1" style="display: inline-table; border-collapse: collapse;"> <tr> <td style="padding: 2px 5px;">md</td> <td style="padding: 5px;">Operating mode data</td> </tr> </table> <p style="margin-left: 20px;">Specify operating mode data in BCD code. (Section 6-6)</p>	md	Operating mode data													
md	Operating mode data														
<table border="1" style="display: inline-table; border-collapse: collapse;"> <tr> <td style="padding: 2px 5px;">pd</td> <td style="padding: 5px;">IF passband width data</td> </tr> </table> <p style="margin-left: 20px;">If the radio is equipped with IF passband width selection capability with the CI-V System, the information can be specified. (Section 6-6)</p>	pd	IF passband width data													
pd	IF passband width data														

7-5 VFO selection command

Command 07H	Sub commands 00H~D1H	Selects VFO mode. Selects VFO A or VFO B. [VFO]																				
■ Controller → radio		■ Radio → controller																				
<table border="1" style="width: 100%; text-align: center; border-collapse: collapse;"> <tr> <td style="width: 12.5%;">FE</td> <td style="width: 12.5%;">FE</td> <td style="width: 12.5%;">ra</td> <td style="width: 12.5%;">E0</td> <td style="width: 12.5%;">07</td> <td style="width: 12.5%;">sc</td> <td style="width: 12.5%;">FD</td> </tr> </table>		FE	FE	ra	E0	07	sc	FD	<table border="1" style="width: 100%; text-align: center; border-collapse: collapse;"> <tr> <td style="width: 12.5%;">FE</td> <td style="width: 12.5%;">FE</td> <td style="width: 12.5%;">E0</td> <td style="width: 12.5%;">ra</td> <td style="width: 12.5%;">FB or FA</td> <td style="width: 12.5%;">FD</td> </tr> </table>	FE	FE	E0	ra	FB or FA	FD							
FE	FE	ra	E0	07	sc	FD																
FE	FE	E0	ra	FB or FA	FD																	
<table border="1" style="width: 100%; border-collapse: collapse;"> <tr> <td style="width: 10%; text-align: center; vertical-align: middle;">ra</td> <td>Receive address Specify a radio's address. (Section 2-5)</td> </tr> <tr> <td style="text-align: center; vertical-align: middle;">E0</td> <td>Transmit address Specify the controller's address, E0H.</td> </tr> <tr> <td style="text-align: center; vertical-align: middle;">07</td> <td>Command number Specify the command number, 07H.</td> </tr> <tr> <td style="text-align: center; vertical-align: middle;">sc</td> <td>Sub command number Specify the sub command number.</td> </tr> </table>	ra	Receive address Specify a radio's address. (Section 2-5)	E0	Transmit address Specify the controller's address, E0H.	07	Command number Specify the command number, 07H.	sc	Sub command number Specify the sub command number.	<table border="1" style="width: 100%; border-collapse: collapse;"> <tr> <td style="width: 10%; text-align: center; vertical-align: middle;">FB</td> <td>OK code When the correct command is received, the radio operates as follows. Selects the specified operation described at left below. Sends back the OK code, FBH.</td> </tr> <tr> <td style="text-align: center; vertical-align: middle;">FA</td> <td>NG code Under the following conditions, the radio sends back the NG code, FAH. The radio is not equipped with the specified function. The radio is not equipped with a VFO.</td> </tr> </table>		FB	OK code When the correct command is received, the radio operates as follows. Selects the specified operation described at left below. Sends back the OK code, FBH.	FA	NG code Under the following conditions, the radio sends back the NG code, FAH. The radio is not equipped with the specified function. The radio is not equipped with a VFO.								
ra	Receive address Specify a radio's address. (Section 2-5)																					
E0	Transmit address Specify the controller's address, E0H.																					
07	Command number Specify the command number, 07H.																					
sc	Sub command number Specify the sub command number.																					
FB	OK code When the correct command is received, the radio operates as follows. Selects the specified operation described at left below. Sends back the OK code, FBH.																					
FA	NG code Under the following conditions, the radio sends back the NG code, FAH. The radio is not equipped with the specified function. The radio is not equipped with a VFO.																					
<table border="1" style="width: 100%; border-collapse: collapse;"> <thead> <tr> <th style="width: 10%; text-align: center;">sc</th> <th style="text-align: center;">Operation</th> </tr> </thead> <tbody> <tr> <td style="text-align: center;">—</td> <td>When no sub command is added, the radio changes from MEMORY mode to the previously used VFO.</td> </tr> <tr> <td style="text-align: center;">00</td> <td>Changes from MEMORY mode to VFO A, or from VFO B to VFO A.</td> </tr> <tr> <td style="text-align: center;">01</td> <td>Changes from MEMORY mode to VFO B, or from VFO A to VFO B.</td> </tr> <tr> <td style="text-align: center;">A0</td> <td>Copies displayed VFO contents to another VFO. [VFO A = VFO B]</td> </tr> <tr> <td style="text-align: center;">B0</td> <td>Exchanges VFO A contents with VFO B contents. [VFO A ↔ VFO B] For the IC-970A/E/H, exchanges MAIN band and SUB band. [MAIN ↔ SUB]</td> </tr> <tr> <td style="text-align: center;">C0</td> <td>Turns the dual watch function OFF.</td> </tr> <tr> <td style="text-align: center;">C1</td> <td>Turns the dual watch function ON.</td> </tr> <tr> <td style="text-align: center;">D0</td> <td>Accesses MAIN band.</td> </tr> <tr> <td style="text-align: center;">D1</td> <td>Accesses SUB band.</td> </tr> </tbody> </table>			sc	Operation	—	When no sub command is added, the radio changes from MEMORY mode to the previously used VFO.	00	Changes from MEMORY mode to VFO A, or from VFO B to VFO A.	01	Changes from MEMORY mode to VFO B, or from VFO A to VFO B.	A0	Copies displayed VFO contents to another VFO. [VFO A = VFO B]	B0	Exchanges VFO A contents with VFO B contents. [VFO A ↔ VFO B] For the IC-970A/E/H, exchanges MAIN band and SUB band. [MAIN ↔ SUB]	C0	Turns the dual watch function OFF.	C1	Turns the dual watch function ON.	D0	Accesses MAIN band.	D1	Accesses SUB band.
sc	Operation																					
—	When no sub command is added, the radio changes from MEMORY mode to the previously used VFO.																					
00	Changes from MEMORY mode to VFO A, or from VFO B to VFO A.																					
01	Changes from MEMORY mode to VFO B, or from VFO A to VFO B.																					
A0	Copies displayed VFO contents to another VFO. [VFO A = VFO B]																					
B0	Exchanges VFO A contents with VFO B contents. [VFO A ↔ VFO B] For the IC-970A/E/H, exchanges MAIN band and SUB band. [MAIN ↔ SUB]																					
C0	Turns the dual watch function OFF.																					
C1	Turns the dual watch function ON.																					
D0	Accesses MAIN band.																					
D1	Accesses SUB band.																					

7-6 Front window selection command

Command 07H	Sub command E0H	Selects the front window. [WINDOW]														
<p>■ Controller → radio</p> <table border="1"> <tr> <td>FE</td> <td>FE</td> <td>ra</td> <td>E0</td> <td>07</td> <td>E0</td> <td>wn</td> <td>FD</td> </tr> </table> <p>ra Receive address Specify a radio's address. (Section 2-5)</p> <p>E0 Transmit address Specify the controller's address, E0H.</p> <p>07 Command number Specify the command number, 07H.</p> <p>E0 Sub command number Specify the sub command number, E0H.</p> <p>wn Window number Specify a window number to select for the front window in BCD code. Either 00 or 01 can be specified.</p> <p>NOTE: Window number 00 or 01 is used in the IC-R7100, even though the radio does not indicate it on the function display.</p> <p>There is no command to readout which window is the front window.</p>		FE	FE	ra	E0	07	E0	wn	FD	<p>■ Radio → controller</p> <table border="1"> <tr> <td>FE</td> <td>FE</td> <td>E0</td> <td>ra</td> <td>FB or FA</td> <td>FD</td> </tr> </table> <p>FB OK code When the correct command is received, the radio operates as follows. Selects the specified window as the front window. Sends back the OK code, FBH.</p> <p>FA NG code When the radio is not equipped with the window scan function, the radio sends back NG code, FAH.</p>	FE	FE	E0	ra	FB or FA	FD
FE	FE	ra	E0	07	E0	wn	FD									
FE	FE	E0	ra	FB or FA	FD											

7-7 Memory channel commands

Command **08H** Selects MEMORY mode or specifies a memory channel number. [MR]

■ Controller → radio

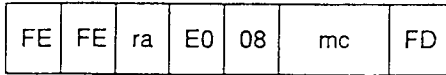

- ra** **Receive address**
Specify a radio's address. (Section 2-5)
- E0** **Transmit address**
Specify the controller's address, E0H.
- 08** **Command number**
Specify the command number, 08H.
- mc** **Memory channel number**
Specify the memory channel number in BCD code.

■ Radio → controller

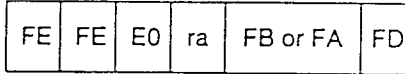

- FB** **OK code**
When the correct command is received, the radio operates as follows.
Selects the previously used or specified memory channel.
Sends back the OK code, FBH.
- FA** **NG code**
If the radio is not equipped with the specified memory channel, the radio sends back the NG code, FAH.

mc	Operation
—	When no memory channel number is specified, the radio selects the previously used memory channel.
00~99	Selects specified memory channel 0~99.
0100~9999	Selects specified memory channel 100~9999. A call channel or scan edge channel can be specified. (Sections 6-1-6-5)

[Example] Selects memory channel 15.

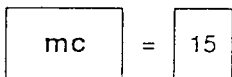

[Example] Selects memory channel 102.

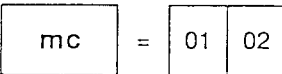

Command 09H	Writes displayed contents into a selected memory channel. [MW]												
<p>■ Controller → radio</p> <table border="1" style="margin: 10px auto; border-collapse: collapse;"> <tr> <td style="padding: 2px 10px;">FE</td> <td style="padding: 2px 10px;">FE</td> <td style="padding: 2px 10px;">ra</td> <td style="padding: 2px 10px;">E0</td> <td style="padding: 2px 10px;">09</td> <td style="padding: 2px 10px;">FD</td> </tr> </table> <p>ra Receive address Specify a radio's address. (Section 2-5)</p> <p>E0 Transmit address Specify the controller's address, E0H.</p> <p>09 Command number Specify the command number, 09H.</p>	FE	FE	ra	E0	09	FD	<p>■ Radio → controller</p> <table border="1" style="margin: 10px auto; border-collapse: collapse;"> <tr> <td style="padding: 2px 10px;">FE</td> <td style="padding: 2px 10px;">FE</td> <td style="padding: 2px 10px;">E0</td> <td style="padding: 2px 10px;">ra</td> <td style="padding: 2px 10px;">FB or FA</td> <td style="padding: 2px 10px;">FD</td> </tr> </table> <p>FB OK code When the correct command is received, the radio operates as follows. Writes displayed contents including the operating frequency, mode, etc. into the previously selected memory channel. Sends back the OK code, FBH.</p> <p>FA NG code If the radio is not equipped with any memory channel, the radio sends back the NG code, FAH.</p>	FE	FE	E0	ra	FB or FA	FD
FE	FE	ra	E0	09	FD								
FE	FE	E0	ra	FB or FA	FD								

Command 0AH	Copies selected memory channel contents into a VFO. [M → VFO]												
<p>■ Controller → radio</p> <table border="1" style="margin: 10px auto; border-collapse: collapse;"> <tr> <td style="padding: 2px 10px;">FE</td> <td style="padding: 2px 10px;">FE</td> <td style="padding: 2px 10px;">ra</td> <td style="padding: 2px 10px;">E0</td> <td style="padding: 2px 10px;">0A</td> <td style="padding: 2px 10px;">FD</td> </tr> </table> <p>ra Receive address Specify a radio's address. (Section 2-5)</p> <p>E0 Transmit address Specify the controller's address, E0H.</p> <p>0A Command number Specify the command number, 0AH.</p>	FE	FE	ra	E0	0A	FD	<p>■ Radio → controller</p> <table border="1" style="margin: 10px auto; border-collapse: collapse;"> <tr> <td style="padding: 2px 10px;">FE</td> <td style="padding: 2px 10px;">FE</td> <td style="padding: 2px 10px;">E0</td> <td style="padding: 2px 10px;">ra</td> <td style="padding: 2px 10px;">FB or FA</td> <td style="padding: 2px 10px;">FD</td> </tr> </table> <p>FB OK code When the correct command is received, the radio operates as follows. Copies displayed memory channel contents including the operating frequency, mode, etc. into the previously used VFO. Sends back the OK code, FBH.</p> <p>FA NG code If a blank channel is selected, the radio sends back the NG code, FAH.</p> <p>NOTE: The displayed memory channels content are not affected.</p>	FE	FE	E0	ra	FB or FA	FD
FE	FE	ra	E0	0A	FD								
FE	FE	E0	ra	FB or FA	FD								

Command 0BH Clears selected memory channel contents. [M CLEAR]													
<p>■ Controller → radio</p> <table border="1" style="width: 100%; text-align: center;"> <tr> <td>FE</td> <td>FE</td> <td>ra</td> <td>E0</td> <td>0B</td> <td>FD</td> </tr> </table> <p>ra Receive address Specify a radio's address. (Section 2-5)</p> <p>E0 Transmit address Specify the controller's address, E0H.</p> <p>0B Command number Specify the command number, 0BH.</p>	FE	FE	ra	E0	0B	FD	<p>■ Radio → controller</p> <table border="1" style="width: 100%; text-align: center;"> <tr> <td>FE</td> <td>FE</td> <td>E0</td> <td>ra</td> <td>FB or FA</td> <td>FD</td> </tr> </table> <p>FB OK code When the correct command is received, the radio operates as follows. Writes the memory blank code, FFH, into the selected memory channel. Sends back the OK code, FBH.</p> <p>FA NG code If the radio is not equipped with any memory channel, the radio sends back the NG code, FAH.</p> <p>NOTE: The IC-761 or a radio that is equipped with the CI-IV System preserves previous memory contents even though contents of blank channels are not displayed.</p>	FE	FE	E0	ra	FB or FA	FD
FE	FE	ra	E0	0B	FD								
FE	FE	E0	ra	FB or FA	FD								

7-8 Offset frequency commands

Command 0CH	Reads out offset frequency contents in a displayed VFO or memory channel.																							
<p>■ Controller → radio</p> <table border="1" style="width: 100%; text-align: center; border-collapse: collapse;"> <tr> <td style="width: 15%;">FE</td> <td style="width: 15%;">FE</td> <td style="width: 15%;">ra</td> <td style="width: 15%;">E0</td> <td style="width: 15%;">0C</td> <td style="width: 15%;">FD</td> </tr> </table> <p>ra Receive address Specify a radio's address. (Section 2-5)</p> <p>E0 Transmit address Specify the controller's address, E0H.</p> <p>0C Command number Specify the command number, 0CH.</p>	FE	FE	ra	E0	0C	FD	<p>■ Radio → controller</p> <table border="1" style="width: 100%; text-align: center; border-collapse: collapse;"> <tr> <td style="width: 15%;">FE</td> <td style="width: 15%;">FE</td> <td style="width: 15%;">E0</td> <td style="width: 15%;">ra</td> <td style="width: 15%;">0C</td> <td style="width: 15%;">od</td> <td style="width: 15%;">FD</td> </tr> </table> <p>od Offset frequency data When the correct command is received, the radio sends back offset frequency data in BCD code.</p> <p>[Example] When offset frequency is 20 MHz.</p> <table style="margin-left: 20px;"> <tr> <td style="border: 1px solid black; padding: 2px 5px;">od</td> <td style="padding: 0 10px;">=</td> <td style="border: 1px solid black; padding: 2px 5px;">00</td> <td style="border: 1px solid black; padding: 2px 5px;">00</td> <td style="border: 1px solid black; padding: 2px 5px;">20</td> </tr> <tr> <td></td> <td></td> <td style="text-align: center;">①</td> <td style="text-align: center;">②</td> <td style="text-align: center;">③</td> </tr> </table> <ul style="list-style-type: none"> ①: 1 kHz digit ②: 100 Hz digit ③: 100 kHz digit ④: 10 kHz digit ⑤: 10 MHz digit ⑥: 1 MHz digit <p>NOTE: If the offset frequency is not included, the radio sends back 000000. If a blank channel is selected, the radio sends back the NG code, FAH. (Section 5-3)</p>	FE	FE	E0	ra	0C	od	FD	od	=	00	00	20			①	②	③
FE	FE	ra	E0	0C	FD																			
FE	FE	E0	ra	0C	od	FD																		
od	=	00	00	20																				
		①	②	③																				

Command 0DH	Writes offset frequency data into a displayed VFO or memory channel.													
<p>■ Controller → radio</p> <table border="1" style="width: 100%; text-align: center; border-collapse: collapse;"> <tr> <td style="width: 15%;">FE</td> <td style="width: 15%;">FE</td> <td style="width: 15%;">ra</td> <td style="width: 15%;">E0</td> <td style="width: 15%;">0D</td> <td style="width: 15%;">od</td> <td style="width: 15%;">FD</td> </tr> </table> <p>ra Receive address Specify a radio's address. (Section 2-5)</p> <p>E0 Transmit address Specify the controller's address, E0H.</p> <p>0D Command number Specify the command number, 0DH.</p> <p>od Offset frequency data Specify offset frequency data in BCD code as in the example shown in command 0CH.</p>	FE	FE	ra	E0	0D	od	FD	<p>■ Radio → controller</p> <table border="1" style="width: 100%; text-align: center; border-collapse: collapse;"> <tr> <td style="width: 15%;">FE</td> <td style="width: 15%;">FE</td> <td style="width: 15%;">E0</td> <td style="width: 15%;">ra</td> <td style="width: 15%;">FB or FA</td> <td style="width: 15%;">FD</td> </tr> </table> <p>FB OK code When the correct command is received, the radio operates as follows. Writes the specified offset frequency data into the displayed VFO or memory channel. Sends back the OK code, FBH.</p> <p>FA NG code If the radio is not equipped with the offset function, the radio sends back the NG code, FAH.</p>	FE	FE	E0	ra	FB or FA	FD
FE	FE	ra	E0	0D	od	FD								
FE	FE	E0	ra	FB or FA	FD									

7-9 Scan start/stop command

Command 0EH	Sub commands 00H~42H	Starts and stops a scan function.																																																
<p>■ Controller → radio</p> <p>These commands are used for scan start/stop controls.</p> <p>For scan controls on the front window in the IC-R7100, this command is used. For window scan controls, refer to Sections 7-12 and 7-13.</p> <table border="1" style="width: 100%; text-align: center;"> <tr> <td>FE</td><td>FE</td><td>ra</td><td>E0</td><td>0E</td><td>sc</td><td>FD</td> </tr> </table> <p>ra Receive address Specify a radio's address. (Section 2-5)</p> <p>E0 Transmit address Specify the controller's address, E0H.</p> <p>0E Command number Specify the command number, 0EH.</p> <p>sc Sub command number Specify the sub command number. (Section 7-11)</p> <p>[Example] Starts programmed scan or memory scan.</p> <table border="1" style="width: 100%; text-align: center;"> <tr> <td>FE</td><td>FE</td><td>ra</td><td>E0</td><td>0E</td><td>01</td><td>FD</td> </tr> </table> <p>[Example] Stops scan.</p> <table border="1" style="width: 100%; text-align: center;"> <tr> <td>FE</td><td>FE</td><td>ra</td><td>E0</td><td>0E</td><td>00</td><td>FD</td> </tr> </table> <p>[Example] Starts auto memory write scan.</p> <table border="1" style="width: 100%; text-align: center;"> <tr> <td>FE</td><td>FE</td><td>ra</td><td>E0</td><td>0E</td><td>04</td><td>FD</td> </tr> </table> <p>[Example] Starts selected number memory scan.</p> <table border="1" style="width: 100%; text-align: center;"> <tr> <td>FE</td><td>FE</td><td>ra</td><td>E0</td><td>0E</td><td>23</td><td>FD</td> </tr> </table> <p>[Example] Starts priority scan. (except for the IC-R7100)</p> <table border="1" style="width: 100%; text-align: center;"> <tr> <td>FE</td><td>FE</td><td>ra</td><td>E0</td><td>0E</td><td>42</td><td>FD</td> </tr> </table> <p>NOTE: Selectable sub command differs according to radios and operating conditions. (Sections 7-11)</p>		FE	FE	ra	E0	0E	sc	FD	FE	FE	ra	E0	0E	01	FD	FE	FE	ra	E0	0E	00	FD	FE	FE	ra	E0	0E	04	FD	FE	FE	ra	E0	0E	23	FD	FE	FE	ra	E0	0E	42	FD	<p>■ Radio → controller</p> <table border="1" style="width: 100%; text-align: center;"> <tr> <td>FE</td><td>FE</td><td>E0</td><td>ra</td><td>FB or FA</td><td>FD</td> </tr> </table> <p>FB OK code When the correct command is received, the radio operates as follows. Performs the specified function. Sends back the OK code, FBH.</p> <p>FA NG code Under the following conditions, the radio sends back the NG code, FAH. When the specified function could not be performed. Selectable sub command differs according to VFO mode or MEMORY mode. The radio is not equipped with the specified scan function.</p>	FE	FE	E0	ra	FB or FA	FD
FE	FE	ra	E0	0E	sc	FD																																												
FE	FE	ra	E0	0E	01	FD																																												
FE	FE	ra	E0	0E	00	FD																																												
FE	FE	ra	E0	0E	04	FD																																												
FE	FE	ra	E0	0E	23	FD																																												
FE	FE	ra	E0	0E	42	FD																																												
FE	FE	E0	ra	FB or FA	FD																																													

7-10 Scan condition command

Command	0EH	Sub commands	A0H-D3H	Specifies the scan conditions.																																												
<p>■ Controller → radio</p> <table border="1"> <tr> <td>FE</td><td>FE</td><td>ra</td><td>E0</td><td>0E</td><td>sc</td><td>sn</td><td>FD</td> </tr> </table> <p>ra Receive address Specify a radio's address. (Section 2-5)</p> <p>E0 Transmit address Specify the controller's address, E0H.</p> <p>0E Command number Specify the command number, 0EH.</p> <p>sc Sub command number Specify the sub command number. (Section 7-11)</p> <p>sn Selected number For sub command number B1H or B2H, this data can be specified in BCD code.</p> <p>[Example] Specifies the selected number as non effective for a displayed memory channel.</p> <table border="1"> <tr> <td>FE</td><td>FE</td><td>ra</td><td>E0</td><td>0E</td><td>B0</td><td>FD</td> </tr> </table> <p>[Example] Specifies the selected number 8 for the displayed memory channel.</p> <table border="1"> <tr> <td>FE</td><td>FE</td><td>ra</td><td>E0</td><td>0E</td><td>B1</td><td>08</td><td>FD</td> </tr> </table> <p>[Example] Specifies scan number 5 for the selected number memory scan.</p> <table border="1"> <tr> <td>FE</td><td>FE</td><td>ra</td><td>E0</td><td>0E</td><td>B2</td><td>05</td><td>FD</td> </tr> </table> <p>[Example] Turns the VSC function ON.</p> <table border="1"> <tr> <td>FE</td><td>FE</td><td>ra</td><td>E0</td><td>0E</td><td>C1</td><td>FD</td> </tr> </table>		FE	FE	ra	E0	0E	sc	sn	FD	FE	FE	ra	E0	0E	B0	FD	FE	FE	ra	E0	0E	B1	08	FD	FE	FE	ra	E0	0E	B2	05	FD	FE	FE	ra	E0	0E	C1	FD	<p>■ Radio → controller</p> <table border="1"> <tr> <td>FE</td><td>FE</td><td>E0</td><td>ra</td><td>FB or FA</td><td>FD</td> </tr> </table> <p>FB OK code When the correct command is received, the radio operates as follows. Performs the specified function. Sends back the OK code, FBH.</p> <p>FA NG code Under the following conditions, the radio sends back the NG code, FAH. When the specified function could not be performed. Selectable sub command differs according to VFO mode or MEMORY mode. The radio is not equipped with the specified scan function.</p>			FE	FE	E0	ra	FB or FA	FD
FE	FE	ra	E0	0E	sc	sn	FD																																									
FE	FE	ra	E0	0E	B0	FD																																										
FE	FE	ra	E0	0E	B1	08	FD																																									
FE	FE	ra	E0	0E	B2	05	FD																																									
FE	FE	ra	E0	0E	C1	FD																																										
FE	FE	E0	ra	FB or FA	FD																																											

7-11 Sub commands for command 0EH

Selectable sub commands for command 0EH

Radios	Selectable sub commands (sc)
IC-735, IC-751, IC-751A, IC-761, IC-271A/E/H, IC-471A/E/H, IC-1271A/E, IC-R71, IC-R7000	No scan function control capability via the CI-V System.
IC-725, IC-726 IC-737, IC-765, IC-575A/H, IC-275A/E/H, IC-375A, IC-475A/E/H, IC-1275A/E, IC-970A/E/H	00H, 01H
IC-781	00H-03H, 12H-23H, A0H-B2H
IC-R9000	00H, 02H-04H, 22H-42H, A0H-D3H
IC-R72	00H-02H, 04H, 22H, 23H, B0H, B1H
IC-R7100	00H, 02H, 04H, 22H-42H, B0H-D1H, D3H

Sub commands 00H-42H

sc	Operation
00	Scan stops.
01	Programmed scan or memory scan starts.
02	Programmed scan starts.
03	Δf scan starts.
04	Auto memory write scan starts.
12	Fine programmed scan starts.
13	Fine Δf scan starts.
22	Memory scan starts.
23	Selected number memory scan starts.
24	Selected mode memory scan starts.
42	Priority scan or basic window scan starts.

NOTE: For the IC-R7100, sub commands except 01H, 03H, 12H and 13H, described above are used.

For window scan controls, a window number MUST be added. (Sections 7-12, 7-13)

Sub commands A0H-D3H

sc	Operation
A0	Unfixes the center frequency for Δf scan.
AA	Fixes the center frequency for Δf scan.
A1	Selects Δf frequency width of ± 2.5 kHz.
A2	Selects Δf frequency width of ± 5 kHz.
A3	Selects Δf frequency width of ± 10 kHz.
A4	Selects Δf frequency width of ± 20 kHz.
A5	Selects Δf frequency width of ± 50 kHz.
B0	Selects the selected number non effective for a memory channel.
B1	Selects the selected number effective for a memory channel. For the IC-R9000, specifies the selected number for a memory channel.
B2	Specifies the scan number for a selected number memory scan.
C0	Turns VSC function OFF.
C1	Turns VSC function ON.
D0	Selects scan resume condition [∞].*
D1	Selects scan resume condition [OFF].*
D2	Selects scan resume condition [B].*
D3	Selects scan resume condition [A].*

*Refer to p. 46 of the IC-R9000 instruction manual or p. 22 of the IC-R7100 instruction manual.

7-12 Basic window scan command

Command 0EH	Sub command 42H	Starts a window scan function. [WS]														
<p>■ Controller → radio</p> <p>This command starts the IC-R7100's window scan. [WS]</p> <table border="1"> <tr> <td>FE</td><td>FE</td><td>ra</td><td>E0</td><td>0E</td><td>42</td><td>wn</td><td>FD</td> </tr> </table> <p>ra Receive address Specify a radio's address. (Section 2-5)</p> <p>E0 Transmit address Specify the controller's address, E0H.</p> <p>0E Command number Specify the command number, 0EH.</p> <p>42 Sub command number Specify the sub command number, 42H.</p> <p>wn Window number Specify the back window number in BCD code. When no window number is specified, previously specified window number is used. Window number 00 or 01 is used in the IC-R7100, even though the radio does not indicate it on the function display. (Section 7-6)</p>		FE	FE	ra	E0	0E	42	wn	FD	<p>■ Radio → controller</p> <table border="1"> <tr> <td>FE</td><td>FE</td><td>E0</td><td>ra</td><td>FB or FA</td><td>FD</td> </tr> </table> <p>FB OK code When the correct command is received, the radio operates as follows. Performs the specified function. Sends back the OK code, FBH.</p> <p>FA NG code Under the following conditions, the radio sends back the NG code, FAH. When the specified function could not be performed. When the front window is specified.</p>	FE	FE	E0	ra	FB or FA	FD
FE	FE	ra	E0	0E	42	wn	FD									
FE	FE	E0	ra	FB or FA	FD											

7-13 Advanced window scan start/stop command

Command 0EH	Sub commands 02H-24H	Starts a window scan function.														
<p>■ Controller → radio</p> <p>Advanced window scan start/stop command is special function for the IC-R7100.</p> <p>These commands start advanced window scan. In other words, basic window scan and basic scan start simultaneously.</p>		<p>■ Radio → controller</p>														
<table border="1"> <tr> <td>FE</td><td>FE</td><td>ra</td><td>E0</td><td>0E</td><td>sc</td><td>wn</td><td>FD</td> </tr> </table>		FE	FE	ra	E0	0E	sc	wn	FD	<table border="1"> <tr> <td>FE</td><td>FE</td><td>E0</td><td>ra</td><td>FB or FA</td><td>FD</td> </tr> </table>	FE	FE	E0	ra	FB or FA	FD
FE	FE	ra	E0	0E	sc	wn	FD									
FE	FE	E0	ra	FB or FA	FD											
<p>ra Receive address Specify a radio's address. (Section 2-5)</p> <p>E0 Transmit address Specify the controller's address, E0H.</p> <p>0E Command number Specify the command number, 0EH.</p> <p>sc Sub command number Specify the sub command number. (Section 7-11)</p> <p>wn Window number Specify a window number in BCD code. 00 or 01 can be specified.</p> <p>[Example] Starts programmed scan in window 00. If window 00 is selected as the back window, this command acts the same function as if [W-PR] is pushed. Starts window programmed scan.</p>		<p>FB OK code When the correct command is received, the radio operates as follows. Performs the specified function. Sends back the OK code, FBH.</p> <p>FA NG code Under the following conditions, the radio sends back the NG code, FAH. When the specified function could not be performed.</p>														
<table border="1"> <tr> <td>FE</td><td>FE</td><td>ra</td><td>E0</td><td>0E</td><td>02</td><td>00</td><td>FD</td> </tr> </table>		FE	FE	ra	E0	0E	02	00	FD							
FE	FE	ra	E0	0E	02	00	FD									
<p>[Example] Starts memory scan in window 01. If window 01 is selected as the front window, this command acts the same functions as if [W-MR] and then [WINDOW] are pushed. Starts window memory scan and then changes the window.</p>																
<table border="1"> <tr> <td>FE</td><td>FE</td><td>ra</td><td>E0</td><td>0E</td><td>22</td><td>01</td><td>FD</td> </tr> </table>		FE	FE	ra	E0	0E	22	01	FD							
FE	FE	ra	E0	0E	22	01	FD									

Command 0EH	Sub command 00H	Stops all scans or a specified window scan.														
■ Controller → radio		■ Radio → controller														
<table border="1" style="width: 100%; text-align: center; border-collapse: collapse;"> <tr> <td style="width: 12.5%;">FE</td> <td style="width: 12.5%;">FE</td> <td style="width: 12.5%;">ra</td> <td style="width: 12.5%;">E0</td> <td style="width: 12.5%;">0E</td> <td style="width: 12.5%;">00</td> <td style="width: 12.5%;">wn</td> <td style="width: 12.5%;">FD</td> </tr> </table>		FE	FE	ra	E0	0E	00	wn	FD	<table border="1" style="width: 100%; text-align: center; border-collapse: collapse;"> <tr> <td style="width: 12.5%;">FE</td> <td style="width: 12.5%;">FE</td> <td style="width: 12.5%;">E0</td> <td style="width: 12.5%;">ra</td> <td style="width: 12.5%;">FB or FA</td> <td style="width: 12.5%;">FD</td> </tr> </table>	FE	FE	E0	ra	FB or FA	FD
FE	FE	ra	E0	0E	00	wn	FD									
FE	FE	E0	ra	FB or FA	FD											
<table border="1" style="width: 100%; border-collapse: collapse;"> <tr> <td style="width: 10%; text-align: center;">ra</td> <td> Receive address Specify a radio's address. (Section 2-5) </td> </tr> </table>	ra	Receive address Specify a radio's address. (Section 2-5)	<table border="1" style="width: 100%; border-collapse: collapse;"> <tr> <td style="width: 10%; text-align: center;">FB</td> <td> OK code When the correct command is received, the radio operates as follows. Performs the specified function. Sends back the OK code, FBH. </td> </tr> </table>		FB	OK code When the correct command is received, the radio operates as follows. Performs the specified function. Sends back the OK code, FBH.										
ra	Receive address Specify a radio's address. (Section 2-5)															
FB	OK code When the correct command is received, the radio operates as follows. Performs the specified function. Sends back the OK code, FBH.															
<table border="1" style="width: 100%; border-collapse: collapse;"> <tr> <td style="width: 10%; text-align: center;">E0</td> <td> Transmit address Specify the controller's address, E0H. </td> </tr> </table>	E0	Transmit address Specify the controller's address, E0H.	<table border="1" style="width: 100%; border-collapse: collapse;"> <tr> <td style="width: 10%; text-align: center;">FA</td> <td> NG code When the radio is not equipped with the window scan function, the radio sends back NG code, FAH. </td> </tr> </table>		FA	NG code When the radio is not equipped with the window scan function, the radio sends back NG code, FAH.										
E0	Transmit address Specify the controller's address, E0H.															
FA	NG code When the radio is not equipped with the window scan function, the radio sends back NG code, FAH.															
<table border="1" style="width: 100%; border-collapse: collapse;"> <tr> <td style="width: 10%; text-align: center;">0E</td> <td> Command number Specify the command number, 0EH. </td> </tr> </table>	0E	Command number Specify the command number, 0EH.														
0E	Command number Specify the command number, 0EH.															
<table border="1" style="width: 100%; border-collapse: collapse;"> <tr> <td style="width: 10%; text-align: center;">00</td> <td> Sub command number Specify the sub command number, 00H. </td> </tr> </table>	00	Sub command number Specify the sub command number, 00H.														
00	Sub command number Specify the sub command number, 00H.															
<table border="1" style="width: 100%; border-collapse: collapse;"> <tr> <td style="width: 10%; text-align: center;">wn</td> <td> Window number Specify the window number in BCD code. </td> </tr> </table>	wn	Window number Specify the window number in BCD code.														
wn	Window number Specify the window number in BCD code.															
<table border="1" style="width: 100%; border-collapse: collapse;"> <thead> <tr> <th style="width: 15%;">wn</th> <th>Operation</th> </tr> </thead> <tbody> <tr> <td style="text-align: center;">—</td> <td>When no window number is specified, stops all scan, including window scan.</td> </tr> <tr> <td style="text-align: center;">00</td> <td>Stops scan in window 00 and basic window scan. Scan in window 01 is not stopped. Even if window 01 is specified as the back window, the scan continues on the back window.</td> </tr> <tr> <td style="text-align: center;">01</td> <td>Stops scan in window 01 and basic window scan. Scan in window 00 is not stopped. Even if window 00 is specified as the back window, the scan continues on the back window.</td> </tr> </tbody> </table>			wn	Operation	—	When no window number is specified, stops all scan, including window scan.	00	Stops scan in window 00 and basic window scan. Scan in window 01 is not stopped. Even if window 01 is specified as the back window, the scan continues on the back window.	01	Stops scan in window 01 and basic window scan. Scan in window 00 is not stopped. Even if window 00 is specified as the back window, the scan continues on the back window.						
wn	Operation															
—	When no window number is specified, stops all scan, including window scan.															
00	Stops scan in window 00 and basic window scan. Scan in window 01 is not stopped. Even if window 01 is specified as the back window, the scan continues on the back window.															
01	Stops scan in window 01 and basic window scan. Scan in window 00 is not stopped. Even if window 00 is specified as the back window, the scan continues on the back window.															

7-14 Split and duplex command

Command **0FH** Selects split, simplex, +duplex or – duplex. [SPLIT, DUP]

■ Controller → radio

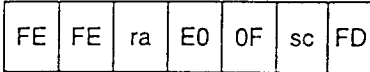

- ra** **Receive address**
Specify a radio's address. (Section 2-5)
- E0** **Transmit address**
Specify the controller's address, E0H.
- 0F** **Command number**
Specify the command number, 0FH.
- sc** **Sub command number**
Specify the sub command number.

sc	Operation
00	Cancels split frequency operation.
01	Selects split frequency operation.
10	Cancels duplex operation.
11	Selects – duplex operation.
12	Selects +duplex operation.

■ Radio → controller

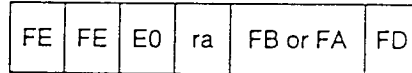

- FB** **OK code**
When the correct command is received, the radio operates as follows.
Selects split, simplex, +duplex or – duplex as specified.
Sends back the OK code, FBH.
- FA** **NG code**
If the radio is not equipped with the specified function, the radio sends back the NG code, FAH.

7-15 Tuning step command

Command **10H** Selects a tuning step. [TS]

■ Controller → radio

FE	FE	ra	E0	10	sc	FD
----	----	----	----	----	----	----

- ra** **Receive address**
Specify a radio's address. (Section 2-5)
- E0** **Transmit address**
Specify the controller's address, E0H.
- 10** **Command number**
Specify the command number, 10H.
- sc** **Sub command number**
Specify the sub command number to control the following radios.

sc	Operation		
	IC-737 IC-R72	IC-R7100	IC-R9000
00	10 Hz	100 Hz	10 Hz
01	1 kHz	1 kHz	100 Hz
02	2 kHz	5 kHz	1 kHz
03	3 kHz	10 kHz	5 kHz
04	4 kHz	12.5 kHz	9 kHz
05	5 kHz	20 kHz	10 kHz
06	6 kHz	25 kHz	12.5 kHz
07	7 kHz	100 kHz	20 kHz
08	8 kHz	—	25 kHz
09	9 kHz	—	100 kHz
10	10 kHz	—	—

■ Radio → controller

FE	FE	E0	ra	FB or FA	FD
----	----	----	----	----------	----

- FB** **OK code**
When the correct command is received, the radio operates as follows.

When the received sub command is 00H.	Turns the [TS] switch OFF. Selects the specified tuning step. Sends back the OK code, FBH.
When the received sub command is 01H-10H.	Turns the [TS] switch ON. Selects the specified tuning step. Sends back the OK code, FBH.

- FA** **NG code**
When the radio is not equipped with the specified function, the radio sends back the NG code, FAH.

7-16 Other commands

Command	11H	Selects an attenuator level. [ATT]																	
<div style="display: flex; justify-content: space-between;"> <div style="width: 48%;"> <p>■ Controller → radio</p> <table border="1" style="width: 100%; text-align: center; border-collapse: collapse;"> <tr> <td style="padding: 2px 5px;">FE</td> <td style="padding: 2px 5px;">FE</td> <td style="padding: 2px 5px;">ra</td> <td style="padding: 2px 5px;">E0</td> <td style="padding: 2px 5px;">11</td> <td style="padding: 2px 5px;">sc</td> <td style="padding: 2px 5px;">FD</td> </tr> </table> <p>ra Receive address Specify a radio's address. (Section 2-5)</p> <p>E0 Transmit address Specify the controller's address, E0H.</p> <p>11 Command number Specify the command number, 11H.</p> <p>sc Sub command number Specify the sub command number to control following radios.</p> </div> <div style="width: 48%;"> <p>■ Radio → controller</p> <table border="1" style="width: 100%; text-align: center; border-collapse: collapse;"> <tr> <td style="padding: 2px 5px;">FE</td> <td style="padding: 2px 5px;">FE</td> <td style="padding: 2px 5px;">E0</td> <td style="padding: 2px 5px;">ra</td> <td style="padding: 2px 5px;">FB or FA</td> <td style="padding: 2px 5px;">FD</td> </tr> </table> <p>FB OK code When the correct command is received, the radio operates as follows. Selects the specified attenuator level. Sends back the OK code, FBH.</p> <p>FA NG code When the radio is not equipped with attenuator level selection capability, the radio sends back NG code, FAH.</p> </div> </div>			FE	FE	ra	E0	11	sc	FD	FE	FE	E0	ra	FB or FA	FD				
FE	FE	ra	E0	11	sc	FD													
FE	FE	E0	ra	FB or FA	FD														
<table border="1" style="width: 100%; border-collapse: collapse;"> <thead> <tr> <th rowspan="2" style="width: 10%;">sc</th> <th colspan="2" style="text-align: center;">Operation</th> </tr> <tr> <th style="width: 40%;">IC-R7100</th> <th style="width: 50%;">IC-R9000</th> </tr> </thead> <tbody> <tr> <td style="text-align: center;">00</td> <td>Turns the attenuator OFF.</td> <td>Turns the attenuator OFF.</td> </tr> <tr> <td style="text-align: center;">10</td> <td style="text-align: center;">—</td> <td>Selects 10 dB attenuator.</td> </tr> <tr> <td style="text-align: center;">20</td> <td>Selects 20 dB attenuator.</td> <td>Selects 20 dB attenuator.</td> </tr> <tr> <td style="text-align: center;">30</td> <td style="text-align: center;">—</td> <td>Selects 30 dB attenuator.</td> </tr> </tbody> </table>			sc	Operation		IC-R7100	IC-R9000	00	Turns the attenuator OFF.	Turns the attenuator OFF.	10	—	Selects 10 dB attenuator.	20	Selects 20 dB attenuator.	Selects 20 dB attenuator.	30	—	Selects 30 dB attenuator.
sc	Operation																		
	IC-R7100	IC-R9000																	
00	Turns the attenuator OFF.	Turns the attenuator OFF.																	
10	—	Selects 10 dB attenuator.																	
20	Selects 20 dB attenuator.	Selects 20 dB attenuator.																	
30	—	Selects 30 dB attenuator.																	

Command 12H Turns ON/OFF the antenna switch or selects an antenna connector.

■ **Controller → radio**

Operation differs according to a radio.

- For the IC-737 : Selects the [ANT 1] or [ANT 2] connector.
- For the IC-9000 : Turns ON or OFF the antenna switch.

FE	FE	ra	E0	12	sc	FD
----	----	----	----	----	----	----

- ra** **Receive address**
Specify a radio's address. (Section 2-5)
- E0** **Transmit address**
Specify the controller's address, E0H.
- 12** **Command number**
Specify the command number, 12H.
- sc** **Sub command number**
Specify the sub command number to control following radios.

sc	Operation	
	IC-737	IC-R9000
00	Selects the [ANT 1] connector.	Turns the antenna switch OFF.
01	Selects the [ANT 2] connector.	Turns the antenna switch ON.

■ **Radio → controller**

FE	FE	E0	ra	FB or FA	FD
----	----	----	----	----------	----

- FB** **OK code**
When the correct command is received, the radio operates as follows.
 - Turns ON or OFF the antenna switch.
 - Sends back the OK code, FBH.
- FA** **NG code**
Under the following conditions, the radio sends back the NG code, FAH.
 - When the radio is not equipped with the antenna input ON/OFF function.
 - When the radio is not equipped with the antenna selection function.
 - For the IC-737, in SET mode, the antenna switch setting "Ant SEL" is "oFF."

- NOTE:** Previous settings are required as following:
- For the IC-737: In SET mode, select the antenna switch setting "Ant SEL" to "on." Refer to p. 32 of the IC-737 instruction manual.
 - For the IC-R9000: Operation differs according to the HF antenna switch on rear panel. Refer to pgs. 5 and 7 of the IC-R9000 instruction manual.

Command 13H An optional voice synthesizer unit announces the frequency and mode. [SPEECH]

■ Controller → radio

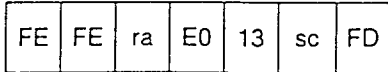

- ra** **Receive address**
Specify a radio's address. (Section 2-5)
- E0** **Transmit address**
Specify the controller's address, E0H.
- 13** **Command number**
Specify the command number, 13H.
- sc** **Sub command number**
Specify the sub command number to control the IC-R72, IC-R7100 and IC-R9000.

■ Radio → controller

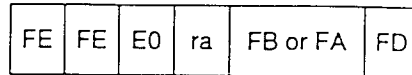

- FB** **OK code**
When the correct command is received, the radio operates as follows.
Announces the specified data for an optional voice synthesizer unit.
Sends back the OK code, FBH.
- FA** **NG code**
When the specified sub command is wrong, the radio sends back the NG code, FAH.

sc	Operation
00	Announces all data.
01	Announces frequency data only.

NOTE: For the IC-R72, IC-R7100 and IC-R9000, an optional voice synthesizer announces frequency data even though it accepts sub command 00H.

Command **14H** Selects the AF gain, RF gain or squelch level.

■ Controller → radio

FE	FE	ra	E0	14	sc	gd	FD
----	----	----	----	----	----	----	----

- ra** **Receive address**
Specify a radio's address. (Section 2-5)
- E0** **Transmit address**
Specify the controller's address, E0H.
- 14** **Command number**
Specify the command number, 14H.
- sc** **Sub command number**
Specify the sub command number to control the IC-R7100 and IC-R9000.

sc	Operation
01	Selects the AF gain level.
02	Selects the RF gain level.
03	Selects the squelch level.

- gd** **Gain or level data**
Specify the gain or level in BCD code. (Section 1-10) 32 levels are selectable.

gd	Gain or level
00~07	0
08~15	1
16~23	2
24~31	3
⋮	⋮
96~0103	12
0104~0111	13
⋮	⋮
0248~0255	31

[Example] Selects AF gain level 0108.

FE	FE	ra	E0	14	01	01	08	FD
----	----	----	----	----	----	----	----	----

■ Radio → controller

FE	FE	E0	ra	FB or FA	FD
----	----	----	----	----------	----

- FB** **OK code**
When the correct command is received, the radio operates as follows:

When the [REMOTE] switch is OFF.	Selects the specified level. Selects the 2 unspecified levels to their initial settings. Turns the [REMOTE] switch ON. Sends back the OK code, FBH.
When the [REMOTE] switch is ON.	Selects the specified level. Sends back the OK code, FBH.

- FA** **NG code**
Under the following conditions, the radio sends back the NG code, FAH.

The radio is not equipped with the specified function.

Specified gain or level is wrong.

NOTE: When remote mode is selected, AF gain, RF gain and squelch level control can only be performed via the controller.

To cancel the remote mode, push the [REMOTE] switch on the radio.

For the IC-R7100, only the AF gain level can be controlled via the controller.

Command 15H Reads out squelch status data and signal strength data.

■ **Controller → radio**

FE	FE	ra	E0	15	sc	FD
----	----	----	----	----	----	----

- ra** **Receive address**
Specify a radio's address. (Section 2-5)
- E0** **Transmit address**
Specify the controller's address, E0H.
- 15** **Command number**
Specify the command number, 15H.
- sc** **Sub command number**
Specify the sub command number the IC-R7100 and IC-R9000.

sc	Operation
01	Reads out whether the squelch is open or closed.
02	Reads out signal strength.

■ **Radio → controller**

FE	FE	E0	ra	15	sc	sd	FD
----	----	----	----	----	----	----	----

- E0** **Receive address**
The radio automatically specifies the controller's address, E0H.
- ra** **Transmit address**
The radio automatically specifies its address.
- 15** **Command number**
The radio automatically specifies the received command number, 15H.
- sc** **Sub command number**
The radio automatically specifies the received sub command number.
- sd** **Status data**
For sub command 01:
The radio sends back the squelch status in BCD code.

[Example] When the squelch is closed.

$$\boxed{sd} = \boxed{00}$$

[Example] When the squelch is open.

$$\boxed{sd} = \boxed{01}$$

For sub command 02:

The radio sends back the signal strength data in BCD code.

[Example] When signal strength is 0234.

$$\boxed{sd} = \boxed{02} \boxed{34}$$

If the radio is not equipped with the specified function, the radio sends back the NG code, FAH.

January 24, 1991 1st edition
May 10, 1991 2nd edition
March 11, 1993 3rd edition

Icom Inc.

6-9-16, Kamihigashi, Hirano-ku, Osaka 547, Japan

Count on us!

Copyright © 1991 by Icom Inc.