

KENWOOD

HF TRANSCEIVER

TS-140S/680S



TS-140S/TS-680S

HF TRANSCEIVER

The TS-140S and TS-680S are a high-performance HF transceiver designed for SSB, CW, AM and FM modes of operation on all Amateur bands. These compact, lightweight units feature the latest technology including an outstanding 500kHz to 30MHz general coverage receiver for superior dynamic range. Main features of the TS-140S and TS-680S include dual digital VFOs, full break-in CW (switchable to semi break-in), 31 memory channels, dual-mode noise blanker, IF shift, RIT, scanning and memory scroll. All of these features are designed to provide you with easier, more convenient operation.



160-m to 10-m Amateur Band Operation with 500kHz to 30MHz General Coverage Receiver

The TS-140S covers all Amateur bands from 160 to 10 meters, including the new WARC 30, 17 and 12 meter bands. Its superior dynamic range general coverage receiver provides reception on any frequency from 500kHz to 30MHz. An innovative double conversion digital PLL synthesized system provides outstanding frequency stability and accuracy. The TS-680S covers all HF bands and the 50 ~ 54MHz 6-m band.

All-Mode Operation

Modes of operation include USB, LSB, CW, AM and FM. Mode selection is quickly accomplished through use of front panel mode keys. International Morse Code confirms the selected mode. Mode selection is automatically selected in SSB mode. LSB below 10MHz and USB above 10MHz.

CW Full Break-In, Semi Break-In and VOX Circuit

Full break-in (QSK) capability allows the DX or contest operator to respond more quickly to the calling station. This capability is made possible through use of microprocessor for the timing chart. A front panel switch permits switching to semi break-in operation.

(On the TS-680S, VOX is optional use VOX-4)

Superior Receiver Dynamic Range

The receiver front end has been specifically designed to provide superior dynamic range. Use of 2SK125 junction-type FETs in the high sensitivity direct balance mixer circuit results in outstanding two-signal characteristics with substantially improved noise floor level. The intermodulation dynamic range is 102dB, with an overall intercept point of +12dBm, noise floor level of -138dBm at 14.200MHz with optional 500Hz CW filter YK-455C-1.

Compact and Lightweight

Even with every conceivable feature built-in, the TS-140S measures only 270 (10.2)W x 96 (3.78)H x 270 (10.2)Dmm (inch), and weighs only 6.1kg (13.45 lbs), allowing operation as a mobile, base, or on DX-peditions.



10Hz Step Dual Digital VFOs

Built-in 10Hz (100Hz in AM, FM modes) step dual digital VFOs operate independently of each other, allowing easier split frequency or cross-band operation in different mode without the need for separate external VFOs. An "A/B" switch allows the operator to specify the VFO to be used. The "SPLIT" switch is for split frequency operations. An "A=B" switch makes it possible to quickly transfer the tuning data (frequency, mode) programmed into the active VFO, in the data banks of an inactive VFO.

31 Memory Channels

31 memory channels store frequency, mode and narrow-wide information in the CW mode, providing increased convenience and simplicity of operation.

•Split memory channels

10 memory channels (from CH-10 to CH-19) store transmit and receive frequencies independently, allowing repeater or split frequency operation.

•Programmable band marker

11 memory channels (From CH-20 to CH-30) establish the upper and lower limits for the programmable band marker. Memory 31 also establishes limits for programmable band scan.

•Depressing the "VFO/M" switch on the front panel permits selection of the memory channels, using the main tuning control. The "M > V" switch is used to transfer memory data to the active VFO.

•Optional TU-8 CTCSS programmable tone encoder

When the optional TU-8 CTCSS encoder is installed, the sub-tone unit is automatically activated in FM mode. Memory channels 10 through 19 are used for repeater (split frequency) operation.

Memory Scan and Band Scan

•Memory scan plus programmable memory channel lock-out

The 31 memory channels may be scanned. A programmable channel lock-out function permits the operator to skip selected channels without loss of data previously stored in those channels.

•Programmable band scan

Scans automatically within the limits specified in memory channel 30.

•Adjustable scanning speed

The scan speed may be continuously varied via the RIT control knob. The scan speed may be increased by shifting the VFO or M-CH/VFO CH knob.

Built-In Dual-Mode Noise Blanker ("Pulse" or "Woodpecker")

Depressing the NB 1 switch effectively suppresses pulse-type (ignition) noise. Depressing the NB 2 switch effectively suppresses longer-duty cycle noise, such as the so-called "woodpecker" type of interference. The NB level control adjusts the threshold level of the noise amplifier, allowing the operator to control the effectiveness of the noise blanker under specific noise and signal level conditions.

IF Shift Circuit

Allows the IF passband to be moved away from interfering signals while keeping the desired signal optimally placed for best gain and signal-to-noise ratio.

Built-In RIT

"RIT" (Receiver Incremental Tuning) shifts only the receiver frequency, to tune in stations slightly off frequency without affecting the transmitter frequency.

UP/DOWN and 1MHz Switches

Front panel UP/DOWN band switches allow easy selection of the desired Amateur band. A 1MHz key steps across the entire frequency range, using UP/DOWN switches.

RF Attenuator

A 20dB RF attenuator, which can be switched into the receiver's front end, provides optimum rejection of intermodulation distortion from extremely strong signals.

IM DYNAMIC RANGE

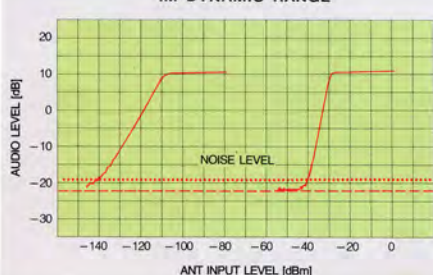

MEMORY keys

F. LOCK: Press this key to lock the VFO and BAND switches
VFO/M: Used to switch alternately between VFO and memory channel
M=V: Used to transfer memory data to the active VFO.
SCAN: Used to activate or stop scan
M.IN: Used to store data in memory channel
CLEAR: Clear

MODE keys: Mode selection accomplished through use of mode keys. International Morse Code confirms the selected mode.

Function keys

• **A/B:** Selects the VFO A or VFO B
 • **SPLIT:** For split frequency operations
 • **A = B:** During VFO operation, press this key to equalize the frequency and mode of the idle VFO to that of the active VFO.

RIT — IF SHIFT controls

RIT: Shifts the receive frequency in 10Hz (or 20Hz) steps within a range of -1.28 ~ 1.27kHz (or -2.56 ~ 2.54kHz) when the RIT switch has been pressed.
IF SHIFT: Shifts the IF passband of receiver, without changing the actual center frequency of the receiver.

AF (Audio Frequency) — SQL controls

MIC (microphone gain) control:

Controls microphone gain for SSB operation.

PWR (RF power) control:

Controls the transmit power.

CW break-in selector (FULL/SEMI/OFF):

During CW operation, selects full break-in, semi break-in or off.

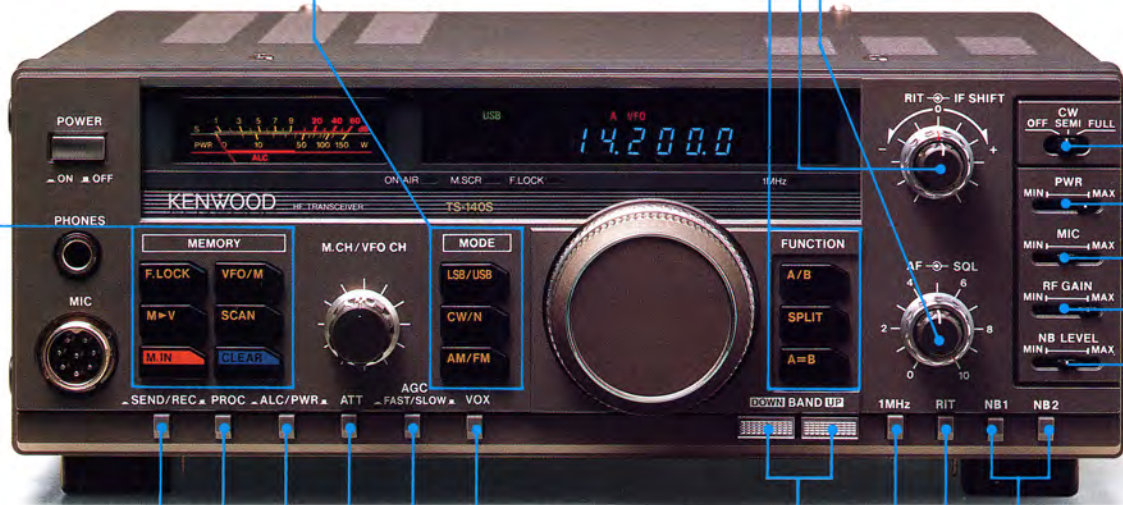

Stand-by switch:

SEND: Transmit **REC:** Receive

PROC (Speech processor) switch:

Used during SSB, AM and FM modes.

ALC/PWR meter switch

ATT (RF Attenuator) switch (-20dB)

AGC (Automatic Gain Control) switch:

Used to select time constant for AGC circuit

VOX switch (TS-140S)

*Pre amp (TS-680S)

BAND switch:

Used to select the Amateur band

or 1MHz frequency step.

1MHz step switch:

ON: 1MHz steps

OFF: Band steps the Amateur band

RIT (Receiver Incremental Tuning) switch

NB 1/NB 2 (Noise blanker) switches

RF GAIN control

NB LEVEL control: Controls noise blanker operating level.

TS-140S/TS-680S SPECIFICATIONS

[GENERAL]

Transmitter Frequency Range...TS-140S: 160, 80, 40, 30, 20, 17, 15, 12, 10 meter Amateur bands
 TS-680S: 160, 80, 40, 30, 20, 17, 15, 12, 10, 6 meter Amateur bands
Receiver Frequency Range...500kHz~30MHz (TS-140S/680S), 50~54MHz (TS-680S)
Mode.....A3J [J3E] (USB, LSB), A1 [A1A] (CW), F3 [F3E] (FM), A3 [A3E] (AM).
Operating Temperature.....-10°C ~ +50°C
Frequency Stability.....Better than $\pm 10 \times 10^{-6}$ (-10°C ~ +50°C)
Frequency Accuracy.....Better than $\pm 10 \times 10^{-6}$
Antenna Impedance.....50 Ω
External Speaker Impedance.....8 ~ 16 Ω
Power Requirement.....Standard 13.8 VDC (12.0 ~ 16.0 VDC)
Power Consumption.....Max. transmit 20A, Receive (no signal) 1.5A
Dimensions.....270 (10.63) W x 96 (3.78) H x 270 (10.63) Dmm (inch)
(Projection not included)
Weight.....6.1kg (13.45 lbs) approx.

[Transmitter]

RF Power Output.....TS-140S: SSB = 110W PEP CW = 100W FM = 50W AM = 40W
 TS-680S: SSB/CW = 100W PEP (160 ~ 15-m), 95W (10-m), 10W (6-m)
 AM = 40W (160 ~ 10-m), 4W (6-m)
 FM = 50W (10-m), 10W (6-m)

Modulation.....SSB = Balanced Modulation
 FM = Reactance Modulation
 AM = Low Level Modulation

FM Maximum Frequency Deviation... ± 5 kHz
Carrier Suppression.....More than 40dB
Spurious Radiation.....Less than -40dB
Unwanted Sideband Suppression.....More than 50dB
Third Harmonic Intermodulation Distortion...Better than -26dB
Microphone Impedance.....500 Ω ~ 50k Ω
Frequency Response.....400 ~ 2,600Hz (-6dB) (SSB)

[Receiver]

Circuitry.....Double conversion system
Intermediate Frequency.....1st IF = 45.055 MHz, 2nd IF = 455kHz
Sensitivity.....at 10dB (S+N/N)

Model	TS-140S/TS-680S		TS-140S	TS-680S	
Frequency	500kHz ~ 1.6MHz	1.6 ~ 21.5MHz	21.5 ~ 30MHz	21.5 ~ 30MHz	50 ~ 54MHz
SSB, CW	Less than 3.98 μ V	Less than 0.25 μ V	Less than 0.18 μ V	Less than 0.16 μ V	Less than 0.16 μ V
AM	Less than 39.8 μ V	Less than 2.5 μ V	Less than 1.78 μ V	Less than 1.58 μ V	Less than 1.58 μ V
FM (SINAD 12dB)	—	—	Less than 0.35 μ V	Less than 0.18 μ V	Less than 0.18 μ V

Squelch Sensitivity.....FM: Less than 0.32 μ V
Image Ratio.....More than 50dB
IF Rejection.....More than 50dB
Selectivity.....SSB/CW = 2.2kHz (-6dB), 4.4kHz (-60dB)
 AM = 6kHz (-6dB), 18kHz (-50dB)
 FM = 12kHz (-6dB), 25kHz (-50dB)

RIT Variable Range.....-1.28 ~ +1.27kHz (10Hz step)
 -2.56 ~ 2.54kHz (20Hz step)

IF Shift Variable

Range..... ± 1.28 kHz

Audio Output

Impedance.....8 ~ 16 Ω

Audio Output Power.....1.5W (8 Ω at 10% distortion)

The equipment meets or exceeds published specifications.
 Specifications are subject to change without notice due to advance in technology.

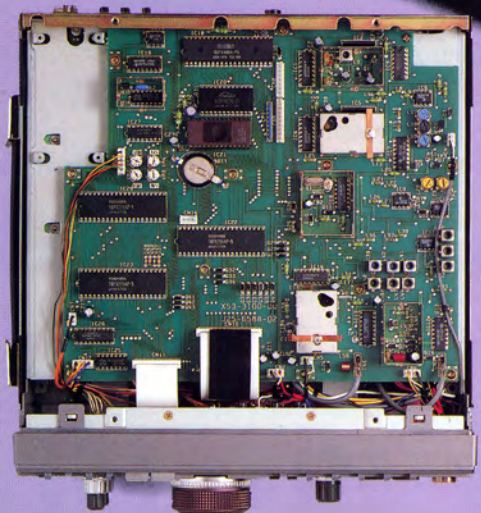

TS-680S: 6-m + HF Transceiver

The TS-680S covers the 6-meter Amateur band, as well as all HF bands. The TS-680S is similar to the TS-140S but does not include VOX.

SENSITIVITY vs FREQUENCY [SSB]

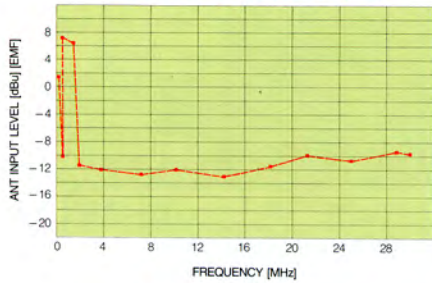

TX SPURIOUS CW 3.75MHz

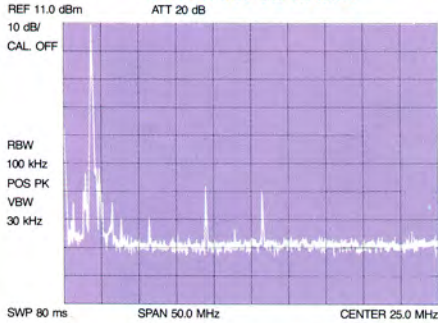

TX SPURIOUS CW 28.800MHz

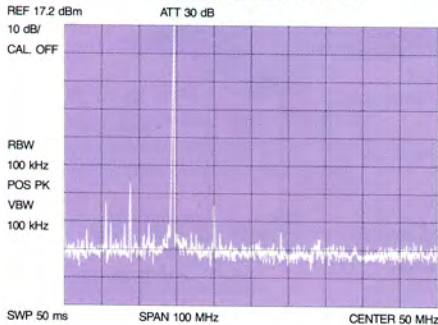

Switchable AGC Circuit (FAST/SLOW)

The automatic gain control (AGC) is activated by a 2-position (FAST/SLOW) switch, to provide optimum receiver operation in CW, SSB and AM modes.

Adjustable VFO Tuning Torque

The tuning control torque is adjustable using the outer ring of the main knob.

Built-In Speech Processor

A front panel switch activates the speech processor circuit, with an audio compression amplifier, resulting in a marked improvement in intelligibility, and a substantial increase in average "talk-power."

Squelch Circuit

The squelch circuit effectively suppresses background noise in the FM mode.

Optional Personal Computer Control (IF-232C/IF-10C)

The interface units are compatible with computers equipped with accessible RS-232C ports. Although software is not available from KENWOOD, several companies are producing programs for the KENWOOD interface.

RF Output Power Control

Using a front panel RF power control, the RF output power may be continuously varied from 10 watts to maximum power. (TS-680S: RF output power on 6-m variable from 1 watt to 10 watts)

"F. LOCK" Switch

The "F. LOCK" switch protects against accidental frequency shifts that may occur when the tuning knob is accidentally bumped.

Memory Scroll

By depressing the "M, IN" switch, the convenient "memory scroll" function may be used to check memory channel data or to find the vacant channel on the display without changing operating frequency and mode.

Non-Volatile Operating System with Lithium Battery Memory Back-Up

All KENWOOD transceivers retain micro-coded operating functions when the lithium memory cells fail. No factory re-programming is necessary! Memory and VFO information is backed-up by an internal lithium battery.

Optional Automatic Antenna Tuner (AT-250)

The optional HF Automatic Antenna Tuner AT-250 provides ABC (Automatic Band Changing) when used with the TS-140S.

Fluorescent Tube Digital Display

The fluorescent tube digital display indicates frequency, mode, memory channel, scan, VFO A/B, SPLIT, RIT frequencies.

Supplied Accessories

- Operating manual
- Hand microphone
- DC cable with fuse
- CAL code
- 7 pin DIN plug

TS-140S BLOCK DIAGRAM

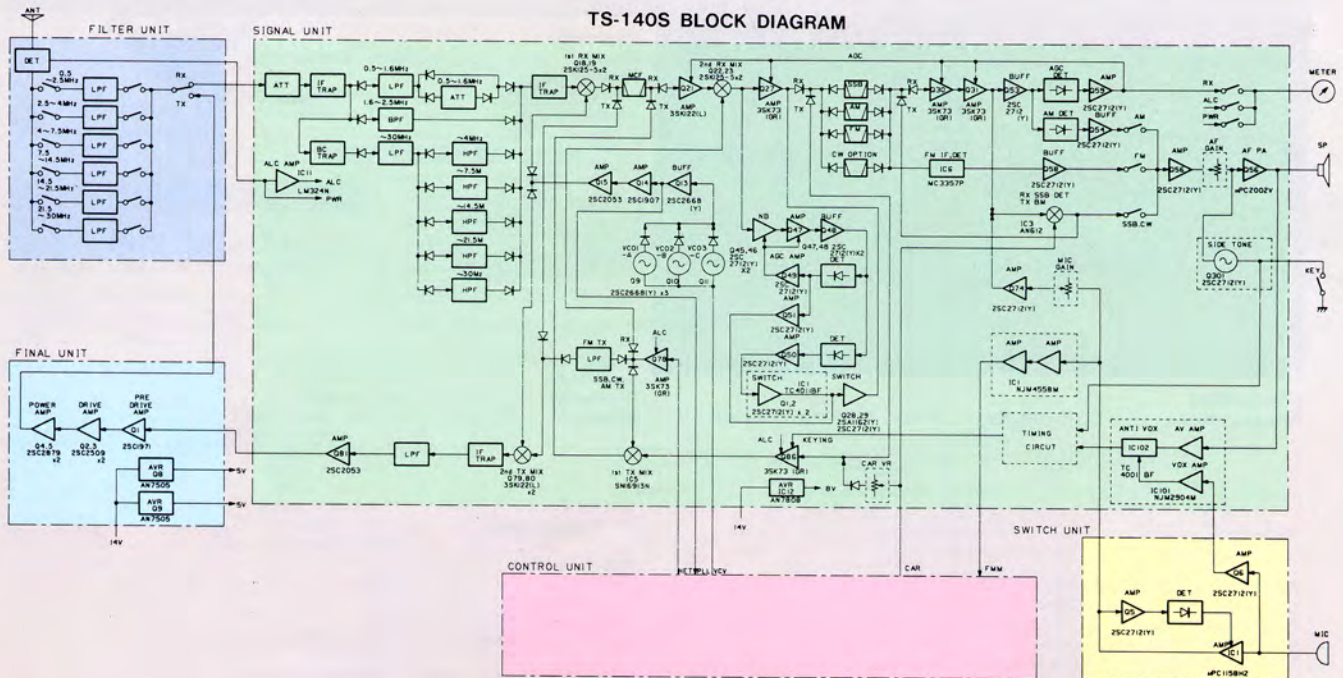

Note: Block Diagram is subject to change without notice due to advancements in technology.

TS-140S/680S Optional Accessories



MC-80

PS-430

SP-430

TS-140S

AT-250

MC-80 (8 pin): Desk-Top Microphone

With built-in Pre-Amplifier (700Ω)
Omnidirectional electret condenser microphone



PS-430: DC Power Supply

Supplies regulated 13.8 VDC at 10A continuous 20A intermittent with built-in cooling fan and protection circuits for maximum reliability.



SP-430: External Speaker

An attractive, compact and low-distortion external speaker designed for base station use.



AT-250: Automatic Antenna Tuner (160-m ~ 10-m bands)

The AT-250 is an automatic antenna tuner that can be used with the TS-140S.

[Features]

- Full coverage of 160 through 10 meters, including the WARC bands.
- ABC (Automatic Band Changing) system when used with the TS-140S and TS-430S. Manual band selection when used with other HF transceivers.
- AC power supply, built-in, with DC terminals.
- Built-in SWR/POWER meter indicates peak power on SSB, average power in other modes, does not require user calibration adjustment.
- Four separate sets of antenna terminals are provided.

MC-85 (8 pin): Deluxe Desk-Top Microphone

With built-in Audio Level Compensation (700Ω) Unidirectional electret condenser



YK-455C-1/YG-455C-1: 500Hz Plug-In CW Filters



SP-40/SP-50B : Compact Mobile Speaker

Compact and smart, high quality external speakers, provide flexibility of installation for maximum convenience.



MC-60A (8 pin): Deluxe Desk-Top Microphone

With built-in Pre-Amplifier (50kΩ/500Ω) Unidirectional dynamic microphone



SW-200A, 2000: SWR/POWER Meter for base station use

200A: 1.8 ~ 150MHz (0 ~ 20/200W)
2000: 1.8 ~ 54MHz (0 ~ 200/2000W)



TL-922A: HF Linear Amplifier

The TL-922A is class AB grounded grid linear amplifiers using two high-performance EIMAC 3-500Z power tubes. The TL-922A covers 160-m ~ 15-m for SSB (2kW PEP input), CW and RTTY (1kW DC input) modes. (Not usable with full break in CW (QSK) semi break-in only)

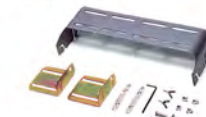

AT-130: Antenna Tuner (80-m ~ 10-m bands)

A compact and lightweight antenna tuner designed for a base or mobile use.

MC-55 (8 pin): Mobile Microphone

With time-out-timer (700Ω) Electret condense microphone



SW-100A: SWR/POWER Meter (1.8 ~ 150MHz) for mobile use. (0 ~ 150W)



MB-430: Mobile Mount

Allows easy installation and removal of the TS-140S.



HS-5: Deluxe Headphones (8 Ω)
HS-6: Small-sized Headphones (12.5 Ω)

MC-43S (8 pin): UP/DOWN Microphone (500Ω)



IF-232C/IF-10C: Interface unit. (software is not available from Kenwood)



MA-5: 5 Band Helical Type HF Mobile Antenna covers 10, 15, 20, 40, 75m
(VP-1: Bumper Mount for MA-5)



PG-2S: DC Cable



PC-1A: Phone Patch Controller (FCC Part 68 registered)



TU-8: CTCSS Encoder unit



*Some accessories may not be available in your area.

KENWOOD U.S.A. CORPORATION
COMMUNICATIONS & TEST EQUIPMENT GROUP
P.O. BOX 22745, 2201 East Dominguez St., Long Beach, CA 90801-5745