

KENWOOD

HF TRANSCEIVER

TS-530SP



The TS-530SP HF transceiver designed in accordance with KENWOOD latest, most advanced circuit technology providing wide dynamic range, high sensitivity, very sharp selectivity with

FEATURES

160-10 Meter Coverage, Including Three New Bands

The TS-530SP transmits and receives on all amateur frequencies between 1.8 and 29.7 MHz, including the new 10, 18, and 24 MHz bands. It also receives WWV on 10 MHz, handy for checking the calibration of the highly accurate digital display. Operating modes include LSB, USB, and CW.

Built-in Digital Display

Frequencies are easy to read on the large, built-in, six-digit, fluorescent-tube display, backed up by an analog subdial. The actual receive and transmit frequencies on all modes and all bands are indicated by means of a common division of the 10 MHz oscillator frequency for the PLL circuit, calibration circuit, and frequency counter.

Narrow/Wide Filter Combinations

The "NAR" switch allows selection of wide and narrow bandwidths on CW and or SSB, when one or two optional filters are installed. The various filter bandwidth mode combinations are shown in the chart below. (receiving only)

The optional 500 Hz CW filter provides excellent selectivity for general-purpose and contest operation. The 270 Hz filter provides a very narrow passband, ideal for DX chasing under crowded band conditions. The 1.8 kHz SSB filter is especially handy during contests and in DX pileups, when QRM is heavy.

IF Shift Reduces QRM

IF shift is built into the TS-530SP to allow the IF passband to be moved around the received signal and away from interfering signals and sideband splatter. Even greater selectivity is achieved when an optional YK-88SN (1.8 kHz), YK-88C (500 Hz), or YK-88CN (270 Hz) filter is installed, to work in combination with the IF shift.

TS-530SP OPTIONAL FILTER COMBINATIONS

MODE	SSB		CW	
	WIDE	NARROW	WIDE	NARROW
YK-88SN	2.4kHz	1.8kHz	2.4kHz	1.8kHz
YK-88C	2.4kHz	—	2.4kHz	500 Hz
YK-88CN	2.4kHz	—	2.4kHz	270 Hz
YK-88SN + YK-88C	2.4kHz	1.8kHz	*2.4kHz or 1.8kHz	500 Hz
YK-88SN + YK-88CN	2.4kHz	1.8kHz	*2.4kHz or 1.8kHz	270 Hz
YK-88C + YK-88CN	2.4kHz	(500 Hz)	500 Hz	270 Hz

*2.4kHz or 1.8kHz selected by inside jumper.

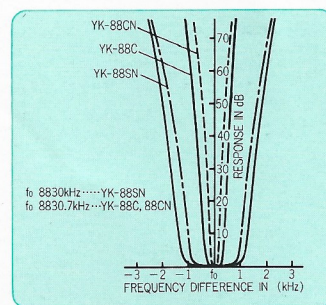

• Filter Attenuation Characteristics

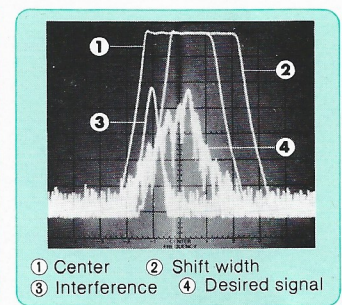

• How IF Shift Eliminates Interference

Tuneable Notch Filter built-in

A sharp notch filter is built into the audio circuit, tuneable, to permit adjustment of system for best interference rejection.

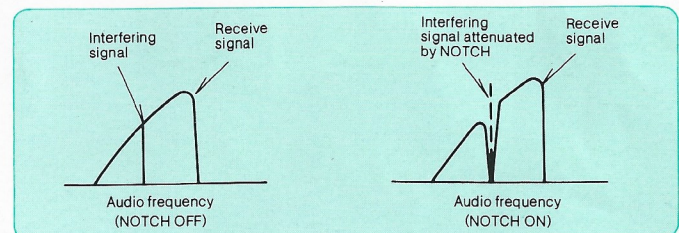

• Notch Control

Wide Receiver Dynamic Range

The receiver section exhibits a very wide dynamic range with unusually good IMD rejection characteristics, resulting in greater immunity to strong, local signals. Its MOS FET RF amplifier operates at a low level of amplification, for improved IMD characteristics. A higher level of amplification is not required because of the balanced mixer's low noise figure, produced by junction FETs. A dual resonator is provided for each band. The result is a very sensitive receiver section with excellent dynamic range and a low noise level.

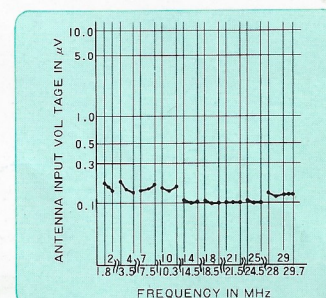

• Receiver Sensitivity

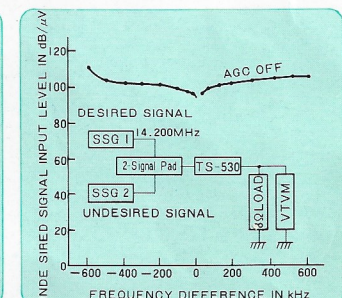

• Sensitivity/Suppression characteristics

is
D's
y,
h
h

sel
bu
and
eco
10



Built-in Speech Processor

The speech processor in the TS-530SP combines an audio compression amplifier with change of ALC time constant for extra audio punch and increased average SSB output power, with suppressed sideband splatter.

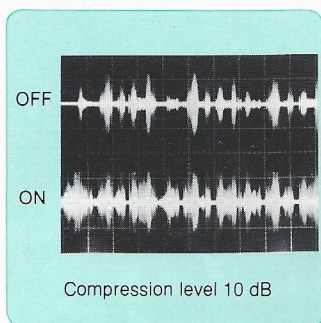

● Speech-Processor Waveform

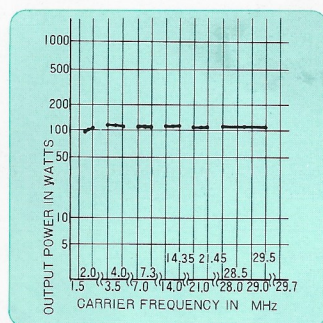

● Output Power (CW)

Two S2001A's or 6146B's in the Final

With a pair of S2001A or 6146B's in the final amplifier, the TS-530SP runs 220W PEP/180 W DC input on all bands.

*USA version 2 x 6146B

Advanced Single-Conversion PLL System

The new PLL circuit in the TS-530SP eliminates the requirement for a crystal element for each band. As shown in the block diagram, the VCO frequency is generated in the PLL circuit by synthesizing the VFO and CAR frequencies, the 10 MHz reference frequency supplied by the counter, and the divided frequency of 500 kHz. Band changing is accomplished by changing the preset division ratio of the programmable divider in the PLL. Thus, the need for a heterodyne crystal element for each operating band is eliminated, resulting in simplified circuitry and improved overall stability. The single-conversion PLL system also improves transmit and receive spurious characteristics, and provides IF shift operation and monodial indication on any mode.

Adjustable Noise-Blanker Level

Pulse-type noise (such as ignition) is eliminated by the built-in noise blanker. The noise amplifier's threshold level can be adjusted by a front-panel control, to enhance the noise blanker's effectiveness under various noise and signal levels.

RF Attenuator for IMD Rejection

A 20 dB RF attenuator, which can be switched into the receiver's front end, provides optimum rejection of intermodulation distortion from extremely strong signals.

More Flexibility with Optional VFOs

The optional VFO-240 allows split-frequency operation for DX chasing, temporary QSY from and fast return to a net frequency, searching for a clear frequency while maintaining the original frequency, and other applications — making it a valuable station addition at an affordable price. For even greater flexibility, the optional VFO-230 digital VFO operates in 20 Hz steps and includes five memories — ideal for retaining net frequencies or DX stations (especially those working by call areas) for later recall.

Expanded Frequency Coverage

The TS-530SP VFO as well as the optional VFO-240 remote VFO cover more than 50 kHz above and below each 500 kHz band. Also, the optional VFO-230 remote digital VFO covers about 100 kHz above and below each band.

Built-in VOX Semi break-in

A VOX circuit is provided in the TS-530SP for optimum SSB operation as well as semi break-in operation on CW. (with side-tone)

Built-in 25 kHz Marker

The built-in 25 kHz marker, derived from the 10 MHz master oscillator, provides an accurate frequency reference for the TS-530SP or any other rig to be calibrated.

RIT/XIT

The front-panel RIT (Receiver Incremental Tuning) control shifts only the receiver frequency, for tuning in stations slightly off frequency without shifting the transmitter frequency. The front-panel XIT (Transmitter Incremental Tuning) shifts only the transmitter frequency, for calling a DX station that may be listening off frequency.

Attractive Appearance with Rugged Construction

The TS-530SP is designed to enhance the appearance of any ham shack, while providing ease of operation with a functional layout of controls. The transceiver, with its front panel of rugged alloy die casting and advanced mechanical engineering throughout, will withstand rough treatment encountered in virtually any operation.

Amplified Type AGC Circuit

The automatic gain control (AGC) is activated by a three-position (OFF/FAST/SLOW) switch to provide optimum receiver operation on CW and SSB under all signal-strength conditions.

Amplified Type ALC Circuit

The amplified type automatic level control (ALC) circuit provides very clean transmit signals.

ectable filters and IF shift, NOTCH filter,
 t-in digital display, speech processor,
 d other features for optimum, yet
 nomical, operation on 160 through
 meters.

Built-in-AC Power Supply

The TS-530SP is a self-contained, compact station with built-in AC power supply.

Final Cooling Fan

A very quiet cooling fan on the rear panel extends tube life in the final amplifier.

LED Indicators

LED indicators on the front panel make operation easier by indicating RIT, XIT, RF attenuator, NOTCH, VFO, and Speech-processor functions.

Tune Function

A TUNE position on the MODE switch is provided for pre-adjustment of the DRIVE control and final tank circuit. In this

position the final screen voltage is reduced approximately 50%, thereby reducing power to prevent damage to the final tubes.

Multifunction Meter

The meter switch selects ALC current, final plate current, relative RF output, and high voltage readings.

Other Versatile Features

- Built-in CW zero-beat function
- Carrier level control
- Microphone gain control
- Heater switch (for driver and final tube filaments)
- Screen-grid switch (on rear panel, for switching off screen voltage on final amplifier when neutralizing)
- Remote terminal (on rear panel, for linear amplifier switching)
- Built-in speaker
- Carrying handle

TS-530SP BLOCK DIAGRAM

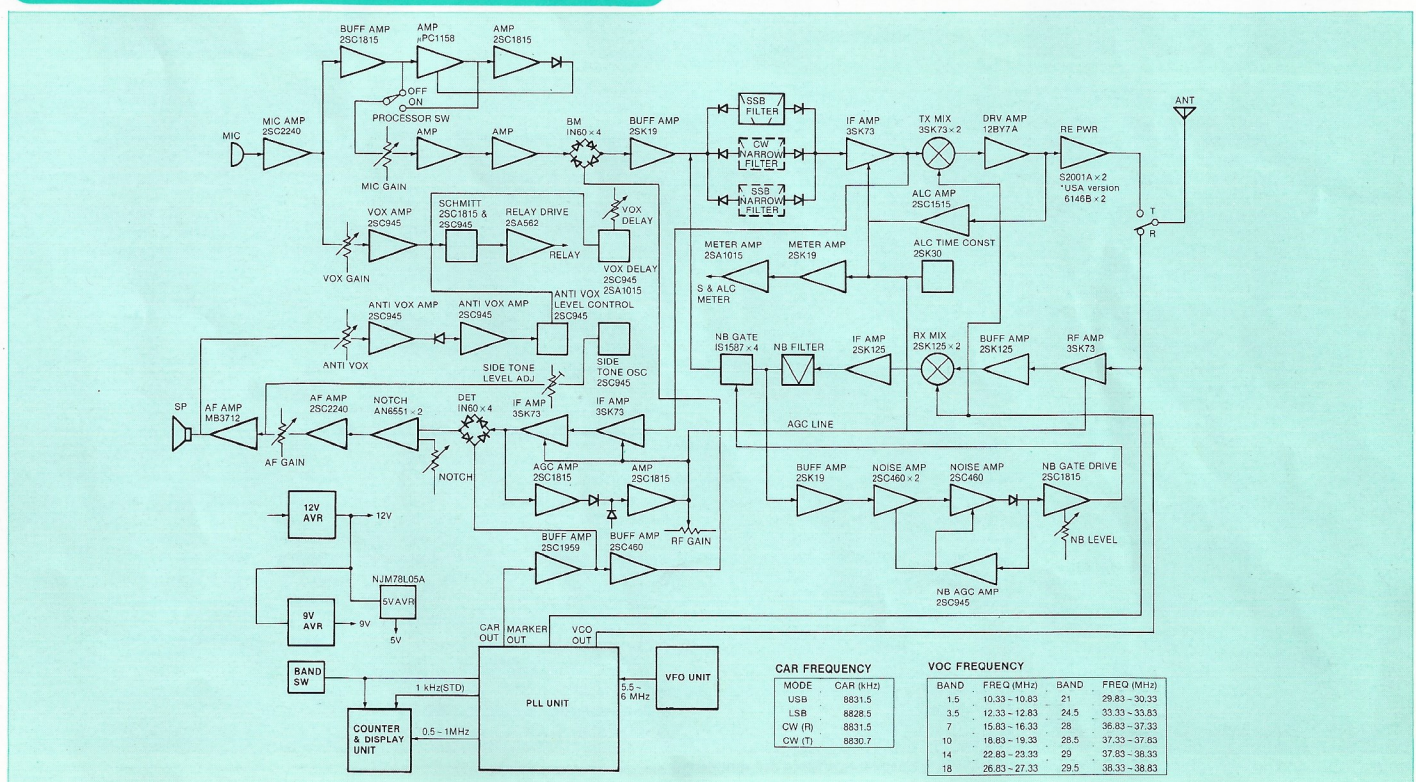

OPTIONAL ACCESSORIES

SM-220 Station Monitor



Based on a wide-frequency-range oscilloscope (up to 10 MHz), the SM-220 station monitor features, in combination with a built-in two-tone generator, a wide variety of wave-form-observing capabilities. An optional feature is a unique pan-display capability. The SM-220 provides efficient station operation as it monitors transmitted waveforms, and it also serves as a high-sensitivity, wide-frequency-range oscilloscope for various adjustments and experiments.

SPECIFICATIONS

•Frequency Range: 1.8–150 MHz •Maximum Power: 1 kW (1.8–54 MHz), 50W (150 MHz) •Deflection Sensitivity: More than 1 div. at 2W input •Attenuator: 6 steps •Power Supply: 120/220/240 V AC, 50/60 Hz, 21 W •Dimensions: 215 (8.6)W x 153 (6.1)H x 355 (13.4)D mm (inch) •Weight: 5 kg (1.1 lbs.)

Pan Display Unit

BC-5 adaptor (for TS-520), BS-8 adaptor (for TS-530SP, TS-830 S/M and TS-180)

Input center frequency: 3.395 MHz (BS-5), 8.830 MHz (BS-8)

•Modifications are required for connection to TS-530SP.

HS-4 (8Ω) Headphones



HS-6 (4 ~ 26Ω) Light-weight Headphones



HS-5 (8Ω) Deluxe Headphones



HS-7 (16Ω) Micro Headphones



YK-88C
500 Hz CW filter
YK-88CN
270 Hz CW narrow filter
YK-88SN
1.8 KHz SSB narrow filter



KB-1
Deluxe VFO knob
•Matches: TS-830S, TS-530SP, TS-820X, R-820, VFO-240



PC-1A
Phone Patch
(Available only where phone patch operation is legal.)



HC-10
Digital World Clock
This clock, incorporating a precise quartz and digital display system as well as a built-in microcomputer, can also recall and display the starting time of QSO for logging purpose.
Power Requirements: 120/220/240V AC.



SW-100A/B
SWR/POWER meter
A: 1.8–150 MHz
B: 140–450 MHz
(0 ~ 150W)



SW-200A/B, 2000
SWR/POWER meter
(supplied a coupler)
200A: 1.8–150 MHz
200B: 140–450 MHz
(0 ~ 20/200W)
2000: 1.8–54 MHz
(0 ~ 200/2000W)



MC-60 (N4)
(50kΩ/500Ω)
Deluxe Desk-top
Microphone
(4 pin)



MC-50 (50kΩ/500Ω)
Desk-top
Microphone
(4 pin)



MC-30S (500Ω)
MC-35S (50kΩ)
Noise Cancelling
Hand Microphone
(4 pin)



MC-60A (500Ω/900Ω)
Deluxe Desk-top
Microphone with
built-in Preamplifier
(8 pin)



MC-80 (700Ω)
Desk-top UP/
DOWN Micro-
phone with built-
in Preamplifier (8 pin)
(Electret condenser
microphone)



MC-85 (700Ω)
Deluxe Desk-Top
UP/DOWN Micro-
phone with built-in
Audio Level
Compensation (8 pin)
(Electret condenser
microphone)



Use **MJ-84** adapter
(8 pin-4 pin)



TS-530SP SPECIFICATIONS

(GENERAL)

Frequency Range..... 160 m Band 1.8 ~ 2.0 MHz
80 m Band 3.5 ~ 4.0 MHz
40 m Band 7.0 ~ 7.3 MHz
30 m Band 10.1 ~ 10.15 MHz
(10.0 MHz WWV)
20 m Band 14.0 ~ 14.35 MHz
17 m Band 18.068 ~ 18.168 MHz
15 m Band 21.0 ~ 21.45 MHz
12 m Band 24.89 ~ 24.99 MHz
10 m Band 28.0 ~ 29.7 MHz
(1) U.S.A. version, diode protected on the new 17
AND 12 meter band to prevent accidental trans-
mission before government amateur authoriza-
tion.
(2) Some of the new WARC bands may be trans-
mitted, depending on the regulations of each
specific country.
Mode..... SSB/CW
RF Output Impedance.... 50Ω ~ 75Ω
Power Requirement..... 120/220/240V AC, 50/60 Hz
Power Consumption..... Transmit: 295 W
Receive: 27 W (with heater OFF)
Dimensions..... 333(13.3)W x 133(5.3)H x 333(13.3)D mm (inch)
Weight..... 12.8 kg (28.2 lbs.)

(TRANSMITTER)

Final Power Input..... 220 W PEP for SSB operation
180 W DC for CW operation
Carrier Suppression..... Better than 40 dB

Unwanted Sideband
Suppression..... Better than 50 dB
Spurious Radiation..... Better than 60 dB
Harmonic Radiation..... Better than 40 dB
Audio Frequency
Response..... 400 to 2,600 Hz, within -6 dB

(RECEIVER)

Sensitivity..... 0.25 μV at 10 dB S+N/N
Image Ratio..... Better than 60 dB
IF Rejection..... Better than 70 dB
Circuitry..... Single Superheterodyne
Intermediate Frequency... IF 8.83 MHz
Frequency Stability..... Within 100 Hz during any 30 minutes period after
warmup.
Within 1 kHz during the first hour after 1 minute of
warmup.
Selectivity.....
SSB/CW WIDE 2.4 kHz (-6 dB), 4.2 kHz (-60 dB)
SSB NARROW With YK-88SN (option filter)
1.8 kHz (-6 dB), 3.3 kHz (-60 dB)
CW NARROW With YK-88C (option filter)
500 Hz (-6 dB), 1.5 kHz (-60 dB)
CW NARROW With YK-88CN (option filter)
270 Hz (-6 dB), 1.1 kHz (-60 dB)
Audio Output
Impedance..... 8Ω ~ 16Ω
Audio Output..... 1.5 W (8Ω)