

# KENWOOD

# TS-890S

## KENWOOD NETWORK COMMAND SYSTEM Setting Manual

JVCKENWOOD Corporation

August/30/2018

## Index

1. Introduction.....	5
2. About Operation Style .....	6
3. Remote operation by LAN connection .....	7
3.1. System configuration / feature of remote control by LAN connection .....	7
3.2. TS-890S settings for remote operation by LAN connection.....	8
3.2.1. Administrator settings.....	8
3.2.2. Registering KNS Users .....	8
3.2.3. Setting the built-in VoIP .....	8
3.2.4. Setting VoIP Input/Output level .....	9
3.2.5. Setting VoIP Jitter Absorption Buffer.....	9
3.2.6. Setting Speaker Mute .....	10
3.2.7. Configuration for KNS Operation .....	10
3.2.8. Timeout timer settings.....	10
3.2.9. Configuration of the Input Path of TX Audio.....	10
3.2.10. Setting and confirming the IP address.....	11
3.2.11. Confirming MAC address .....	11
3.3. Setting and operation of ARCP-890 for remote control by LAN connection .....	12
3.3.1. PC operating environment.....	12
3.3.2. Installing ARCP-890.....	12
3.3.3. Settings for connecting to TS-890S .....	12
3.3.4. Sound device selection and VoIP setting.....	16
3.3.5. Connection and disconnection to TS-890S .....	17
3.3.6. Setting TX Operation for use in ARCP-890 and checking modulation line .....	17
3.3.7. Setting the delay by TX to RX transition .....	18
3.4. PC settings for remote operation by LAN connection.....	19
3.4.1. Windows Firewall settings .....	19
3.4.2. Settings for integrated security software .....	20
4. Remote operation by Internet connection.....	21
4.1. System configuration / feature of remote control by Internet connection.....	21
4.2. TS-890S settings for remote operation by Internet connection .....	22
4.2.1. Administrator settings.....	22
4.2.2. Registering KNS Users .....	22
4.2.3. Setting the built-in VoIP .....	22
4.2.4. Setting VoIP Input/Output level .....	23
4.2.5. Setting VoIP Jitter Absorption Buffer.....	23
4.2.6. Setting Speaker Mute .....	24
4.2.7. Configuration for KNS Operation .....	24

	3
4.2.8. Timeout timer settings.....	24
4.2.9. Configuration of the Input Path of TX Audio.....	25
4.2.10. Setting and confirming the IP address.....	25
4.2.11. Confirming the global IP address.....	25
4.3. ARCP-890 setting and operation for remote control by Internet connection.....	26
4.3.1. PC operating environment.....	26
4.3.2. Installing ARCP-890.....	26
4.3.3. Settings for connecting to TS-890S .....	27
4.3.4. Sound device selection and VoIP setting.....	30
4.3.5. Connection and disconnection to TS-890S .....	31
4.3.6. Setting TX Operation for use in ARCP-890 and checking modulation line .....	31
4.3.7. Setting the delay by TX to RX transition .....	32
4.4. Network settings for remote control by Internet connection.....	33
4.4.1. Required network environment .....	33
4.4.2. Broadband router settings.....	34
4.5. PC settings for remote operation by Internet connection .....	35
4.5.1. Windows Firewall settings .....	35
4.5.2. Settings for integrated security software .....	36
5. Remote operation via the Internet by conventional system .....	37
5.1. Conventional System Configuration .....	37
5.2. TS-890S settings in conventional system.....	38
5.2.1. Administrator settings.....	38
5.2.2. Settings the built-in VoIP(to turn OFF) .....	38
5.2.3. Setting Speaker Mute .....	39
5.2.4. Configuration for KNS Operation .....	39
5.2.5. Timeout timer settings.....	39
5.2.6. Configuration the Input Path of TX Audio .....	39
5.2.7. Setting the ACC 2 audio input / output level .....	40
5.2.8. Setting beep mixed output .....	40
5.2.9. Setting the TX monitor level .....	41
5.2.10. Setting and confirming the IP address.....	41
5.3. ARHP-890 settings in conventional system.....	41
5.3.1. PC operating environment.....	41
5.3.2. Installing ARHP-890 .....	42
5.3.3. Settings for connecting to TS-890S .....	42
5.3.4. Setting KNS.....	45
5.3.5. Connection and disconnection to TS-890S .....	48
5.3.6. Confirming the IP address .....	49
5.3.7. Confirming the global IP address.....	49

	4
5.4. ARCP-890 settings in conventional system.....	49
5.4.1. PC operating environment.....	49
5.4.2. Installing ARCP-890.....	50
5.4.3. Settings for connecting to TS-890S .....	50
5.4.4. Connection and disconnection to TS-890S .....	54
5.4.5. Checking modulation line .....	54
5.4.6. Setting the delay by TX to RX transition .....	55
5.5. Settings of ARVP-10 in conventional system .....	56
5.5.1. Installing ARVP-10 .....	56
5.5.2. Setting ARVP-10 .....	57
5.6. Network settings in conventional system.....	57
5.6.1. Required network environment .....	57
5.6.2. Broadband router settings.....	57
5.7. PC settings in conventional system.....	59
5.7.1. Windows Firewall settings .....	59
5.7.2. Settings for integrated security software .....	60
6. Limitations .....	61
7. Cautions .....	62
8. Frequently Asked Questions .....	63
(Supplement): FAQ: Explaining the Internet "Cannot operate transceiver" .....	71

**Disclaimer:**

- All efforts have been made regarding the accuracy of the contents described in this document. However, there is a possibility of misprints and of descriptions that may cause misunderstanding. JVC KENWOOD Corporation bears absolutely no responsibility for damages arising thereof.
- JVC KENWOOD Corporation may revise and amend the product information described in this document without notice. JVC KENWOOD Corporation bears absolutely no responsibility for damages arising thereof.

- Microsoft®, Windows®, and Windows logo are registered trademarks of Microsoft Corporation in the United States and other countries.
- .NET Framework is a trademark or a registered trademark of Microsoft Corporation in the United States and/or other countries.
- Bluetooth® is a registered trademark or trademark of Bluetooth SIG, Inc.
- All other product names referenced herein are trademarks or registered trademarks of their respective manufacturers.
- The notations of the registered trademarks and trademarks are omitted in this book.

## 1. Introduction

TS-890S can be operated remotely via a home LAN and the Internet by using the remote control software ARCP-890 and KENWOOD NETWORK COMMAND SYSTEM (KNS).

There are several operation styles for remote operation. In this document, we will explain the features of each operation style, the system configuration method, setting method, etc. in detail.

### **Important**

- For remote operation via networks, knowledge not only of transceivers but also of PCs and networks is required. JVC KENWOOD does not offer support for customer PCs and Networks. Furthermore, for operations relating to actual transmitting, note that procedures according to the Radio Act are also required.
- Operations via networks may be delayed due to unavoidable principles. Consequently, do not perform operations (such as contests or pile-ups requiring quick responses) for which delays are likely to be a problem.
- Even if you set by the procedures described in this document, the feature may not work properly because of the combination of PC, the network environment and the sound device.
- Please understand the contents of chapter "6. Limitations" and "7. Cautions", then start remote operation.

## 2. About Operation Style

The operation styles of remote operation in the TS-890S are roughly divided into the following two types.

**Table 2.1 Operation style of remote operation**

Operation style	Connection method	Reference chapter
Operate the TS-890S with a PC from a remote place in the house	LAN	<u>3. Remote operation by LAN connection</u>
Operate the TS-890S with a PC from outside the house	Internet	<u>4. Remote operation by Internet connection</u>

### 3. Remote operation by LAN connection

#### 3.1. System configuration / feature of remote control by LAN connection

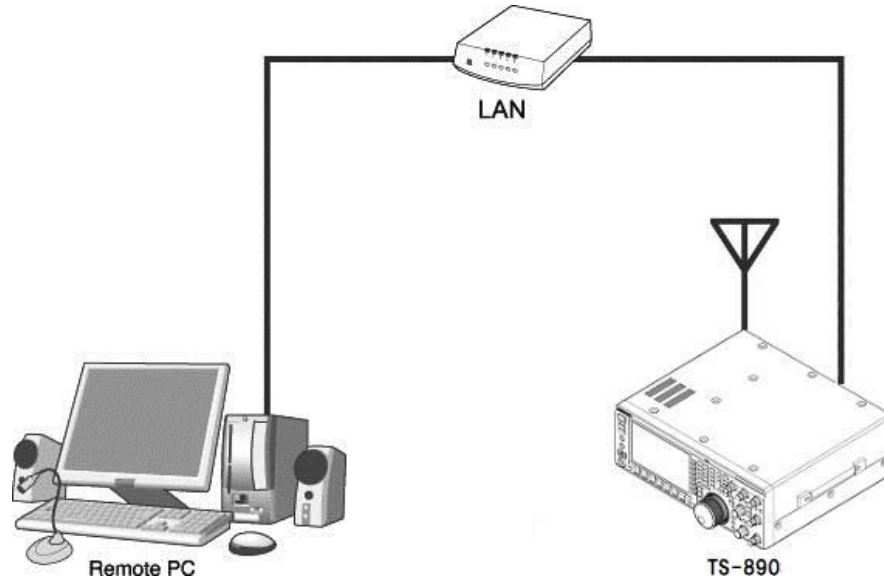

**Fig. 3.1: Remote operation by LAN connection**

As shown in Figure 3.1, connect the TS-890S and the PC running ARCP-890 to the LAN.

The place where PC is installed is called the "Remote station". The place where TS-890S is installed is called the "Host station".

Using the LAN, control command data communication and voice data communication between TS-890S and ARCP-890 are performed. The voice data communication uses the VoIP function built in TS-890S and ARCP-890, and you can listen to the received audio from PC speaker. Audio input to the microphone of the PC can also be transmitted from the TS-890S. (In this document, explains assuming that you will handle transmitted and received audio at the remote station.)

It is also possible to display the band scope on ARCP-890. You can also use the band scope with display speed equal to or higher than that of the TS-890S built-in scope.

## 3.2. TS-890S settings for remote operation by LAN connection

### 3.2.1. Administrator settings

When remote control by LAN connection, login authentication is necessary so as not to be operated by others. For authentication, you must set the information of the administrator (usually the owner of the TS-890S) in TS-890S. Set the following items in KNS menu. For the operation method, refer to the operation manual of the TS-890S.

**Table 3.1 Administrator settings**

KNS Menu	Item
1	Administrator ID
2	Administrator Password

### 3.2.2. Registering KNS Users

It is also assumed that TS-890S will be used by someone other than the administrator (e.g. someone in the family) by remote control via LAN connection. In that case, if the administrator registers information of other users, the registered KNS users can also be remotely controlled.

The KNS user registers with the KNS user list of the TS-890S. The items to register are as shown in the table below. Up to 100 people can be registered. For the operation method, refer to the operation manual of the TS-890S.

**Table 3.2 KNS User settings**

Item	Remarks
User Name	Required
Password	Required
Description	Description about this user (optional)
RX Only	Reception operation is permitted to this user. (transmission is prohibited)
Disabled	Temporarily prohibit access for this user.

### 3.2.3. Setting the built-in VoIP

In the KNS menu, set the built-in VoIP function to "On". For the operation method, refer to the operation manual of the TS-890S.



**Table 3.3 Setting the built-in VoIP**

KNS Menu	Item
3	Built-in VoIP

**3.2.4. Setting VoIP Input/Output level**

There are settings for the input level and output level of VoIP in the KNS menu of the TS-890S, but you use default values normally. Adjust the input level of the microphone connected to the PC and the output level of the speaker, in the setting of the sound device of the PC of the remote station. If it can not be adjusted with the PC, adjust with the KNS menu of the TS-890S. For the operation method, refer to the operation manual of the TS-890S.

**Table 3.4 Setting VoIP Input/Output level**

KNS Menu	Item
4	Audio Input Level (VoIP)
5	Audio Output Level (VoIP)

**Tips:**

If the volume indicator is displayed on the recording device of the PC, adjust the microphone input level of the PC so that the indicator shows about half to about 80% in the usual way of speaking. After then, transmit the TS-890S in SSB mode. If the ALC meter display exceeds the ALC zone, adjust the Audio Input Level (VoIP) of KNS Menu 4 so that it will not exceed the ALC zone.

**3.2.5. Setting VoIP Jitter Absorption Buffer**

Adjust this item in the KNS menu of the TS-890S when there is a problem with the voice quality of VoIP. Selecting a shorter time reduces the audio delay but noise is more likely to occur due to missing audio packets or the like. Selecting a longer time increases the audio delay but noise occurrence due to missing audio packets or the like is potentially reduced. For the operation method, refer to the operation manual of the TS-890S.

**Table 3.5 Setting VoIP Jitter Absorption Buffer**

KNS Menu	Item
----------	------

6	VoIP Jitter Buffer
---	--------------------

### 3.2.6. Setting Speaker Mute

If you want to mute the sound output from the TS-890S speaker during remote operation, set the speaker mute to "On" in the KNS menu. For the operation method, refer to the operation manual of the TS-890S.

**Table 3.6 Setting Speaker Mute**

KNS Menu	Item
7	Speaker Mute

### 3.2.7. Configuration for KNS Operation

In the KNS menu of the TS-890S, set KNS operation (LAN connector) to "On (LAN)". For the operation method, refer to the operation manual of the TS-890S.

**Table 3.7 Configuration for KNS Operation**

KNS Menu	Item
1	KNS Operation(LAN Connector)

### 3.2.8. Timeout timer settings

During KNS operations, control data signals are transmitted using the network. Consequently, if normal network operations are disabled for any reason, control of the TS-890S will also be disabled. Use the following menu to set the functions to stop transmitting automatically after a fixed period if control should be disabled while transmitting.

**Table 3.8 Timeout timer settings**

Menu	Item
6-02	Time-out Timer

### 3.2.9. Configuration of the Input Path of TX Audio

When remotely operating with LAN connection, the audio for transmission is input from the

LAN connector by VoIP. In order to transmit audio from the LAN connector by the transmission operation from the ARCP-890, set the DATA SEND audio input from the rear panel to "LAN" on the "Modulation Source" screen of the TS-890S. (See the screen below)

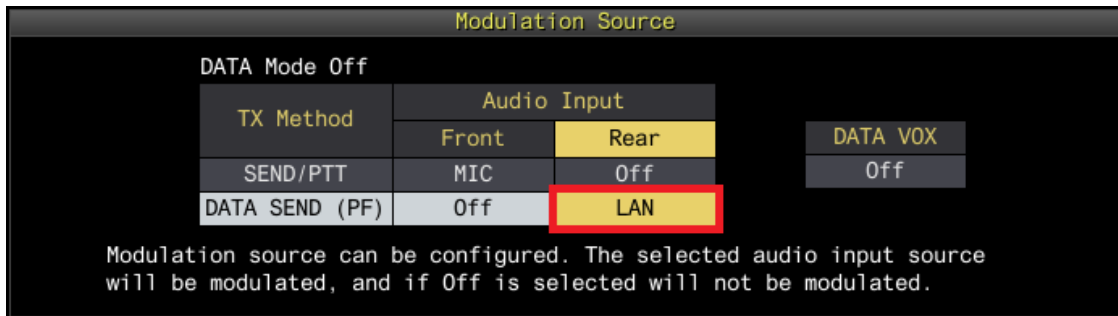

**Fig. 3.2: Configuration of the Input Path of TX Audio**

Also, in order to prevent unintentional transmission during remote control by KNS, set DATA VOX normally select "Off".

(Note) The "Modulation Source" screen shown in Figure 3.2 can be set separately for DATA mode Off and DATA mode On. Please set according to the operation mode.

### 3.2.10. Setting and confirming the IP address

Set the IP address required to access from the remote station. The IP address setting includes automatic setting (using DHCP) and manual setting.

The IP address is set in the LAN menu of the TS-890S. For the operation method, refer to the operation manual of the TS-890S.

When configuring the ARCP-890 of the remote station, there is a place to enter the IP address of the TS-890S, so confirm the IP address you set here.

### 3.2.11. Confirming MAC address

When configuring the ARCP-890 of the remote station, there are places where you enter the MAC address of the TS-890S, so check in advance.

Confirm the MAC address on the LAN menu of the TS-890S. For the operation method, refer

to the operation manual of the TS-890S.

### 3.3. Setting and operation of ARCP-890 for remote control by LAN connection

#### 3.3.1. PC operating environment

When operating remotely via LAN connection, the operating environment required for the PC running ARCP-890 is as follows.

**Table 3.9 PC operating environment**

Operating System (OS)*	Windows 10 (version 1703 (OS Build 15063.0) or later, 32-bit or 64-bit version) Windows 8.1 (RTM or later, 32-bit or 64-bit version) Windows 7 (Service Pack 1 or later, 32-bit or 64-bit version)
Processor	Faster than the recommended CPU for OS on which you are operating
System Memory (RAM)	RAM having the System Memory recommended by the respective OS used in your PC or larger
Free Hard Disk Space	100 MB or more of free hard disk space
Software	Microsoft .NET Framework 4.7 (including .NET Framework 4.0)
Peripheral Devices	Displays with resolutions higher than SXGA (1280 x 1024) Keyboard, mouse or other pointing devices USB 2.0 port or RS-232C interface Network function Available networking environment (LAN or high-speed broadband)

\* Applicable operating systems are subject to change without notice due to the end of the technical support by Microsoft Corporation or change of the product specifications.

#### 3.3.2. Installing ARCP-890

Download and install the ARCP-890 to the PC from the KENWOOD website:

[http://www.kenwood.com/i/products/info/amateur/software\\_download.html](http://www.kenwood.com/i/products/info/amateur/software_download.html)

For the installation method, refer to the guide on the download page.

#### 3.3.3. Settings for connecting to TS-890S

Follow the procedure below to make settings for connecting to TS-890S.

After starting the ARCP-890, select "Settings" in the "Tool" menu, then the "Settings" window opens.

Tips:

When ARCP-890 is started for the first time, the "Initial Setting" window opens and you can make settings for connecting to TS-890S.

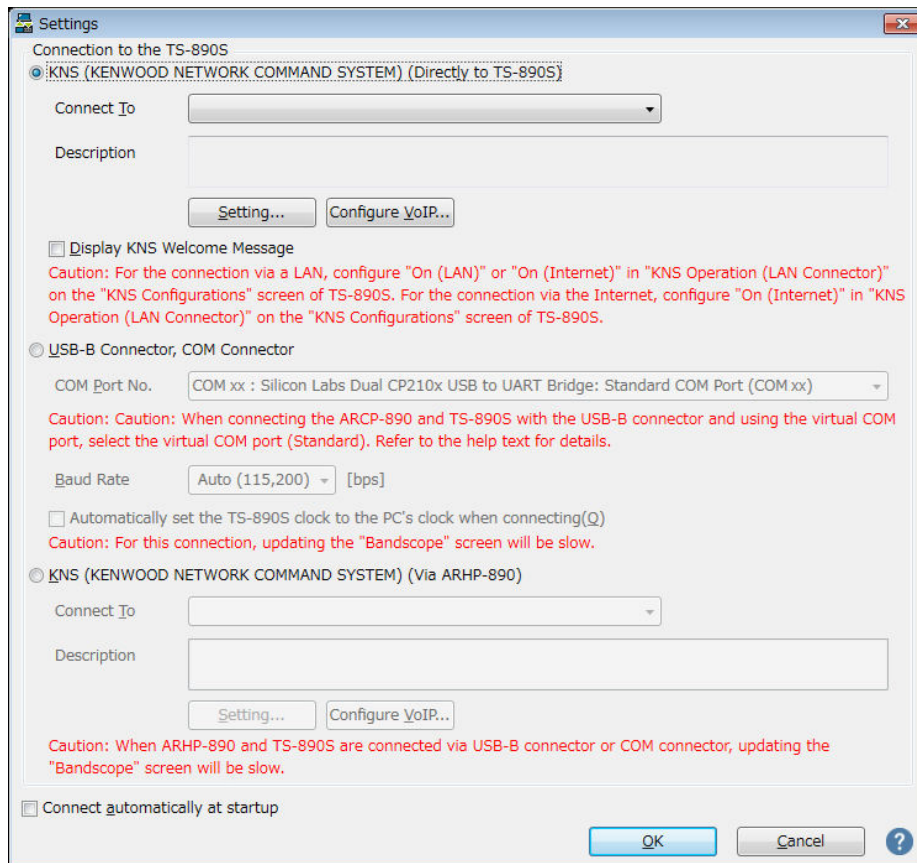

**Fig. 3.3: "Settings" window**

As shown in the above figure, select "KNS (KENWOOD NETWORK COMMAND SYSTEM) (Directly to TS-890S)" in "Connection to TS-890S".

Next, to set the information such as the IP address of the TS-890S of the connection destination, click "Setting" button. The "Configure KNS (Directly to TS-890S) Connection" window opens.

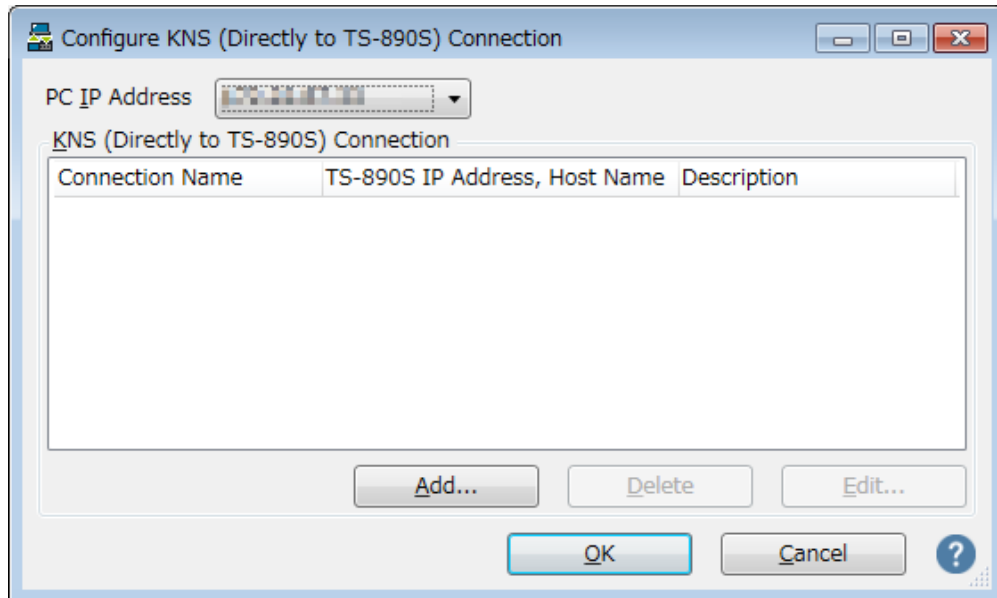

**Fig. 3.4: "Configure KNS (Directly to TS-890S) Connection" window**

Click the "Add" button to add the desired TS-890S to the connection destination list. The following "Edit KNS (Directly to TS-890S) Connection" window opens.

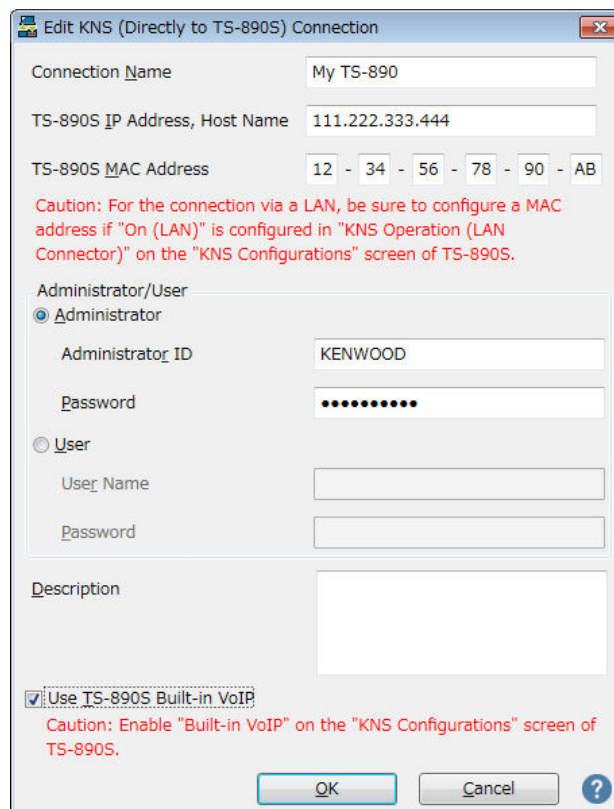

**Fig. 3.5: "Edit KNS (Directly to TS-890S) Connection" window**

Enter an arbitrary name for "Connection Name".

For "TS-890S IP Address, Host Name", enter the IP address of the TS-890S confirmed in

chapter "3.2.10. Setting and checking the IP address".

For "TS-890S MAC Address", enter the MAC address of the TS-890S confirmed in chapter "3.2.11. Checking MAC Address".

If you are the administrator of the TS-890S that you operate remotely, select "Administrator" and enter "Administrator ID" and "Password". For details about the administrator, please refer to chapter "3.2.1. Administrator settings".

If you are a KNS user of the TS-890S that you operate remotely, select "User" and enter "User Name" and "Password". For details about KNS users, see chapter "3.2.2. Registering KNS Users".

In "Description", if there are several TS-890S to be operated remotely, etc., fill in the information on installation location etc. It does not matter if you do not fill in.

Check "Use TS-890S Built-in VoIP".

Finally clicking the "OK" button closes the "Edit KNS (Directly to TS-890S) Connection" window and returns to the "Configure KNS (Directly to TS-890S) Connection" window.

Make sure that the edited information has been added to the connection list.

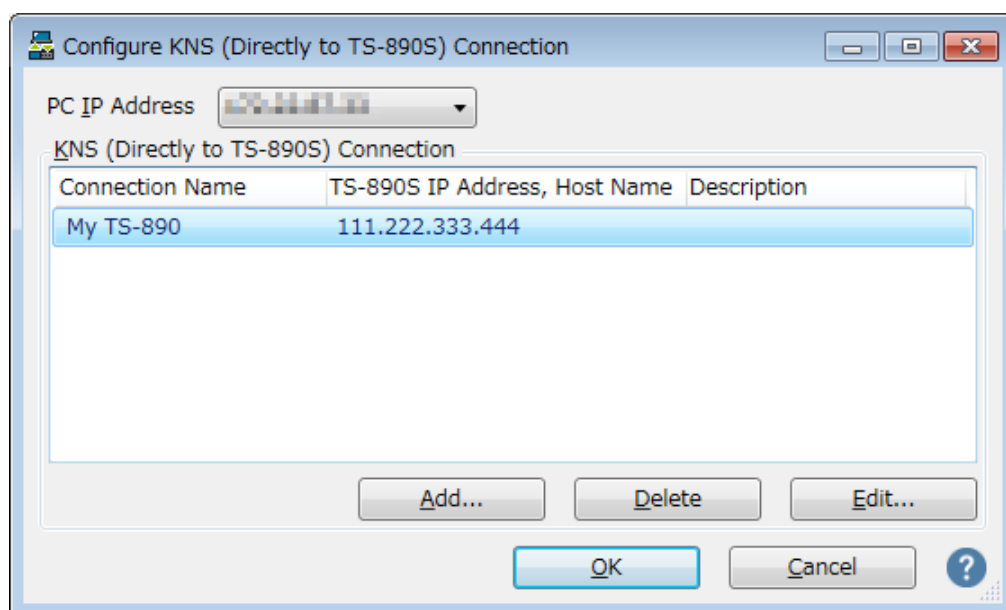

**Fig. 3.6: The connection list after adding the destination**

If you modify, select the connection destination to be modified, click the "Edit" button, open the "Edit KNS (Directly to TS-890S) Connection" window again and modify it.

Select the PC's IP address at "PC IP Address". If there are multiple IP addresses on the PC to be used, select the IP address to be used for connection with the TS-890S.

Clicking the "OK" button closes the "Configure KNS (Directly to TS-890S) Connection" window and returns to the "Setting" window in Figure 3.3.

Check the "Connect To" in the "Settings" window. If more than one connection destination is registered, select from the drop-down list.

Click the "OK" button to close the "Settings" window.

### 3.3.4. Sound device selection and VoIP setting

Select speaker and microphone to be used by remote control and make various settings of VoIP.

When you select "Setting" in "Tools" menu of ARCP - 890, "Setting" window opens. (See Figure 3.3 Settings window)

Click the "Configure VoIP" button. The "Configure VoIP" window opens.

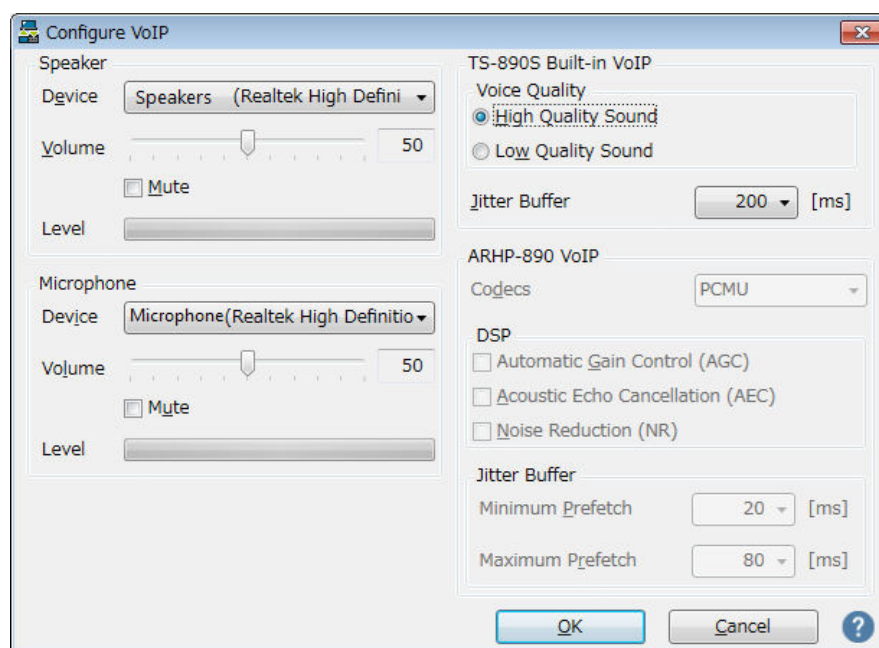

Fig. 3.7: "Configure VoIP" window



Select the speaker and microphone to use from the drop-down list.

Next, set "Voice quality" of "TS-890S Built-in VoIP". Select "High Quality Sound" for remote control by LAN connection.

Next, set "fluctuation absorption buffer". Select "80 ms" for remote control by LAN connection. Adjust this item when there is a problem with the voice quality of VoIP. Selecting a shorter time reduces the audio delay but noise is more likely to occur due to missing audio packets or the like. Selecting a longer time increases the audio delay but noise occurrence due to missing audio packets or the like is potentially reduced. Set the value as small as possible within a range that does not affect the operation.

After setting, click "OK" button and close "Configure VoIP" window.

Tips:

Depending on the OS used on the PC, clicking the "VoIP setting" button at the first start of ARCP-890 may open a "Windows Security Alert" window. Click "Allow access" to advance the setting.

(For details on this window display, see chapter "3.4.1. Windows Firewall Settings")

### **3.3.5. Connection and disconnection to TS-890S**

When you click the "Connect" button in the main window of ARCP-890, the indicator will light green and communication with the TS-890S will start. You can disconnect by clicking the "Connect" button during connection.

### **3.3.6. Setting TX Operation for use in ARCP-890 and checking modulation line**

Set whether the transmission operation from ARCP-890 corresponds to SEND/PTT operation of the TS-890S or DATA SEND operation. In order to operate with the contents set in TS-890S in the chapter "3.2.9. Configuration of the Input Path of TX Audio", set "DATA SEND" for TX operation for use in ARCP-890.

When you are connected to the TS-890S and selecting "Select Modulation Line" from the

"TX/RX" menu of ARCP-890, the "Select Modulation Line" window will be displayed.

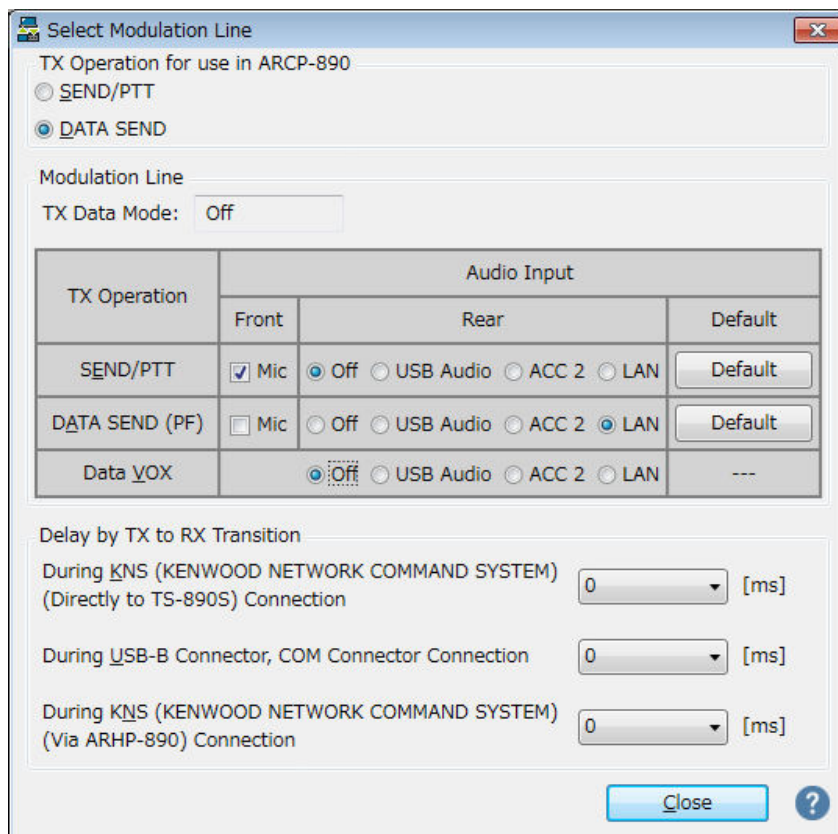

**Fig. 3.8: "Select Modulation Line" window**

As shown in the above figure, select "DATA SEND" for "TX Operation for use in ARCP-890".

For the setting of the modulation line, the contents set in TS-890S are displayed as they are in the chapter "3.2.9. Configuration of the Input Path of TX Audio". As shown in the figure above, when sending by DATA SEND (PF), make sure "LAN" is selected for audio input from rear panel.

After setting and checking, click the "Close" button to close the window.

### 3.3.7. Setting the delay by TX to RX transition

When remote control is performed by LAN connection, the last part of the transmitted voice may be interrupted at the end of transmission. This is due to delay in voice transmission by VoIP.

In order to prevent this, it is possible to delay the timing of switching from transmission to

reception when performing the transmission end operation with ARCP-890.

When you are connected to the TS-890S and selecting "Select Modulation Line" from the "TX/RX" menu of ARCP-890, the "Select Modulation Line" window will be displayed.

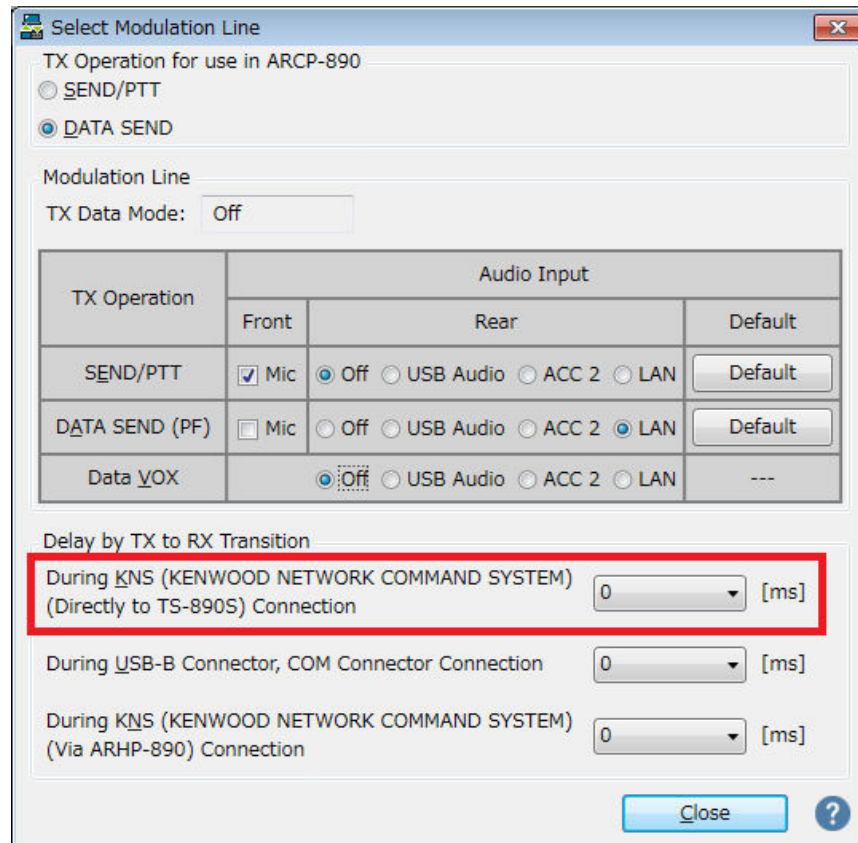

**Fig. 3.9: Set point of "Delay by TX to RX Transition"**

Select the delay time of "During KNS (KENWOOD NETWORK COMMAND SYSTEM) (Directly to TS-890S) Connection" from the drop-down list. After setting, click the "Close" button to close the "Select Modulation Line" window.

### 3.4. PC settings for remote operation by LAN connection

#### 3.4.1. Windows Firewall settings

Depending on the OS used on the PC, the OS may open the "Windows Security Alert" window at the timing of accessing the VoIP function for the first time after the first running of ARCP-890.

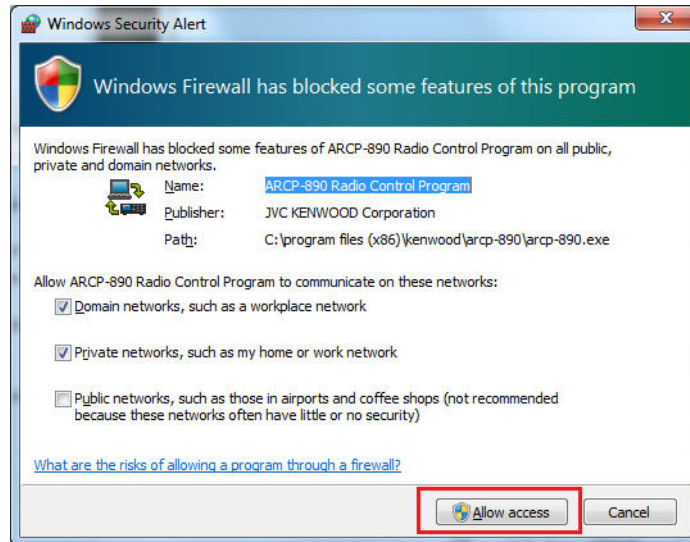

**Fig. 3.10: Windows Firewall Settings**

Click "Allow Access" to allow access to control command data communication and voice data communication of ARCP-890.

**Tips:**

Normally, if you do the above operation, it will not be warned during the use of ARCP-890 after that. If the warning is displayed again while using ARCP-890, add the setting to allow ARCP - 890 communication in the Windows Firewall setting in the control panel.

### **3.4.2. Settings for integrated security software**

When using integrated security software, it is necessary to set it so as not to disturb ARCP - 890 communication. Please refer to the instruction manual of your integrated security software and set it.

## 4. Remote operation by Internet connection

### 4.1. System configuration / feature of remote control by Internet connection

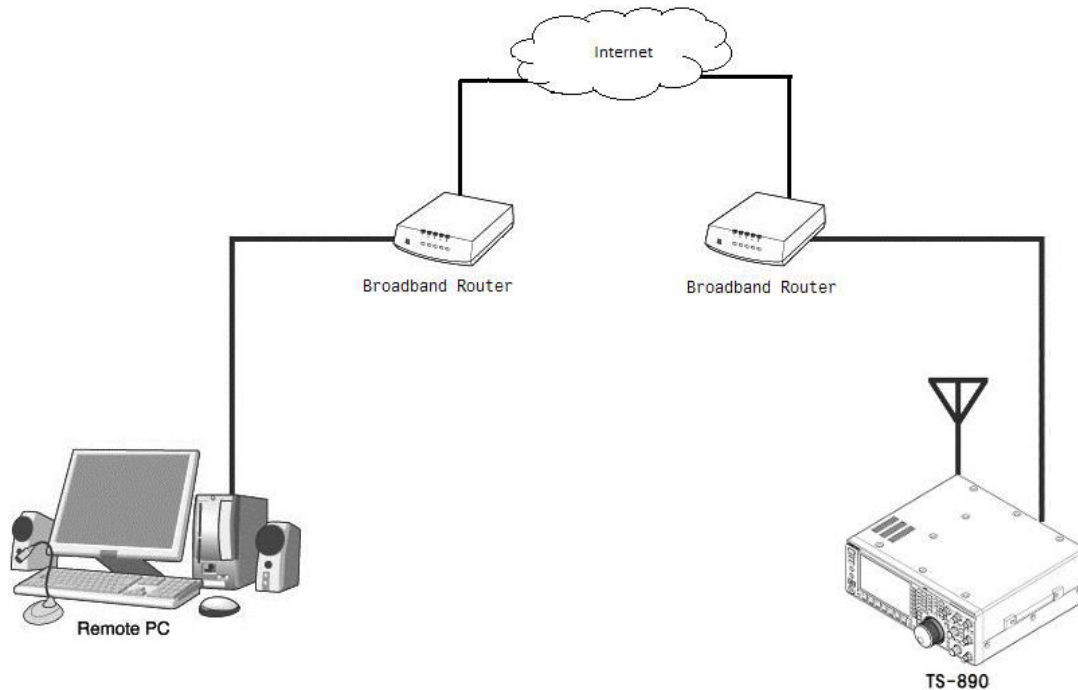

**Fig. 4.1: Remote operation by Internet connection**

As shown in Figure 4.1, connect the TS-890S and the PC running ARCP-890 to the Internet via the broadband router at each installation location.

The place where PC is installed is called the "Remote station". The place where TS-890S is installed is called the "Host station".

Using the Internet, control command data communication and voice data communication between TS-890S and ARCP-890 are performed. The voice data communication uses the VoIP function built in TS-890S and ARCP-890, and you can listen to the received audio from PC speaker. Audio input to the microphone of the PC can also be transmitted from the TS-890S. (In this document, explains assuming that you will handle transmitted and received audio at the remote station.)

It is also possible to display the band scope on ARCP-890. You can also use the band scope with display speed equal to or higher than that of the TS-890S built-in scope.

## 4.2. TS-890S settings for remote operation by Internet connection

### 4.2.1. Administrator settings

When remote control by Internet connection, login authentication is necessary so as not to be operated by others. For authentication, you must set the information of the administrator (usually the owner of the TS-890S) in TS-890S. Set the following items in KNS menu. For the operation method, refer to the operation manual of the TS-890S.

**Table 4.1 Administrator settings**

KNS Menu	Item
1	Administrator ID
2	Administrator Password

### 4.2.2. Registering KNS Users

It is also assumed that TS-890S will be used by someone other than the administrator (e.g. someone in the family) by remote control via Internet connection. In that case, if the administrator registers information of other users, the registered KNS users can also be remotely controlled.

The KNS user registers with the KNS user list of the TS-890S. The items to register are as shown in the table below. Up to 100 people can be registered. For the operation method, refer to the operation manual of the TS-890S.

**Table 4.2 KNS User settings**

Item	Remarks
User Name	Required
Password	Required
Description	Description about this user (optional)
RX Only	Reception operation is permitted to this user. (transmission is prohibited)
Disabled	Temporarily prohibit access for this user.

### 4.2.3. Setting the built-in VoIP

In the KNS menu, set the built-in VoIP function to "On". For the operation method, refer to

the operation manual of the TS-890S.

**Table 4.3 Setting the built-in VoIP**

KNS Menu	Item
3	Built-in VoIP

#### 4.2.4. Setting VoIP Input/Output level

There are settings for the input level and output level of VoIP in the KNS menu of the TS-890S, but you use default values normally. Adjust the input level of the microphone connected to the PC and the output level of the speaker, in the setting of the sound device of the PC of the remote station. If it can not be adjusted with the PC, adjust with the KNS menu of the TS-890S. For the operation method, refer to the operation manual of the TS-890S.

**Table 3.4 Setting VoIP Input/Output level**

KNS Menu	Item
4	Audio Input Level (VoIP)
5	Audio Output Level (VoIP)

Tips:

If the volume indicator is displayed on the recording device of the PC, adjust the microphone input level of the PC so that the indicator shows about half to about 80% in the usual way of speaking. After then, transmit the TS-890S in SSB mode. If the ALC meter display exceeds the ALC zone, adjust the Audio Input Level (VoIP) of KNS Menu 4 so that it will not exceed the ALC zone.

#### 4.2.5. Setting VoIP Jitter Absorption Buffer

Adjust this item in the KNS menu of the TS-890S when there is a problem with the voice quality of VoIP. Selecting a shorter time reduces the audio delay but noise is more likely to occur due to missing audio packets or the like. Selecting a longer time increases the audio delay but noise occurrence due to missing audio packets or the like is potentially reduced. For the operation method, refer to the operation manual of the TS-890S.

**Table 4.5 Setting VoIP Jitter Absorption Buffer**

KNS Menu	Item
6	VoIP Jitter Buffer

#### 4.2.6. Setting Speaker Mute

If you want to mute the sound output from the TS-890S speaker during remote operation, set the speaker mute to "On" in the KNS menu. For the operation method, refer to the operation manual of the TS-890S.

**Table 3.6 Setting Speaker Mute**

KNS Menu	Item
7	Speaker Mute

#### 4.2.7. Configuration for KNS Operation

In the KNS menu of the TS-890S, set KNS operation (LAN connector) to "On (Internet)". For the operation method, refer to the operation manual of the TS-890S.

**Table 4.7 Configuration for KNS Operation**

KNS Menu	Item
1	KNS Operation(LAN Connector)

#### 4.2.8. Timeout timer settings

During KNS operations, control data signals are transmitted using the network. Consequently, if normal network operations are disabled for any reason, control of the TS-890S will also be disabled. Use the following menu to set the functions to stop transmitting automatically after a fixed period if control should be disabled while transmitting.

**Table 4.8 Timeout timer settings**

Menu	Item
6-02	Time-out Timer



#### 4.2.9. Configuration of the Input Path of TX Audio

When remotely operating with Internet connection, the audio for transmission is input from the LAN connector by VoIP. In order to transmit audio from the LAN connector by the transmission operation from the ARCP-890, set the DATA SEND audio input from the rear panel to "LAN" on the "Modulation Source" screen of the TS-890S. (See the screen below)

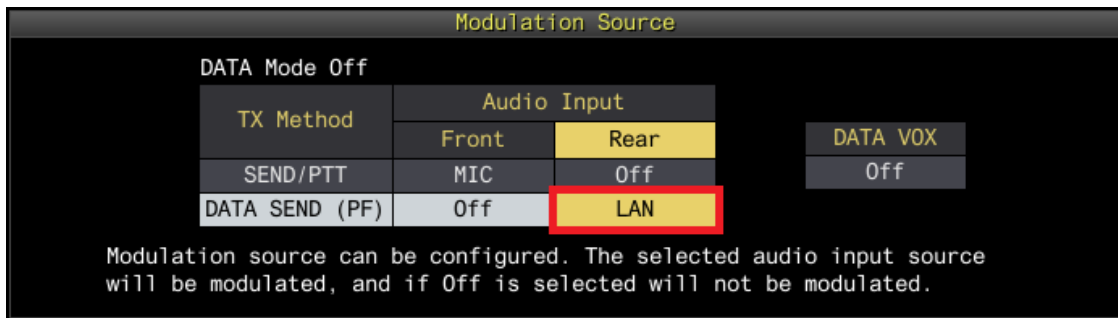

**Fig. 4.2: Configuration of the Input Path of TX Audio**

Also, in order to prevent unintentional transmission during remote control by KNS, set DATA VOX normally select "Off".

(Note) The "Modulation Source" screen shown in Figure 4.2 can be set separately for DATA mode Off and DATA mode On. Please set according to the operation mode.

#### 4.2.10. Setting and confirming the IP address

Set the IP address required for operation in the network environment. The IP address setting includes automatic setting (using DHCP) and manual setting.

The IP address is set in the LAN menu of the TS-890S. For the operation method, refer to the operation manual of the TS-890S.

Since the IP address of the TS-890S is required when setting up the host station's broadband router, confirm the IP address set above. For details on setting to the broadband router, please refer to chapter "4.4.2. Broadband router settings".

#### 4.2.11. Confirming the global IP address

Since the global IP address of host station side is required when setting up the remote

station's ARCP-890, confirm the global IP address in advance. The global IP address is managed by the internet service provider. Ask your internet service provider or check the global IP address that your broadband router is acquiring. (Please refer to the instruction manual of Broadband Router etc.)

### 4.3. ARCP-890 setting and operation for remote control by Internet connection

#### 4.3.1. PC operating environment

When operating remotely via Internet connection, the operating environment required for the PC running ARCP-890 is as follows.

**Table 4.9 PC operating environment**

Operating System (OS)*	Windows 10 (version 1703 (OS Build 15063.0) or later, 32-bit or 64-bit version) Windows 8.1 (RTM or later, 32-bit or 64-bit version) Windows 7 (Service Pack 1 or later, 32-bit or 64-bit version)
Processor	Faster than the recommended CPU for OS on which you are operating
System Memory (RAM)	RAM having the System Memory recommended by the respective OS used in your PC or larger
Free Hard Disk Space	100 MB or more of free hard disk space
Software	Microsoft .NET Framework 4.7 (including .NET Framework 4.0)
Peripheral Devices	Displays with resolutions higher than SXGA (1280 x 1024) Keyboard, mouse or other pointing devices USB 2.0 port or RS-232C interface Network function Available networking environment (LAN or high-speed broadband) Sound function and audio input/output device (microphone and speaker, or headset)

\* Applicable operating systems are subject to change without notice due to the end of the technical support by Microsoft Corporation or change of the product specifications.

#### 4.3.2. Installing ARCP-890

Download and install the ARCP-890 to the PC from the KENWOOD website:

[http://www.kenwood.com/i/products/info/amateur/software\\_download.html](http://www.kenwood.com/i/products/info/amateur/software_download.html)

For the installation method, refer to the guide on the download page.

### 4.3.3. Settings for connecting to TS-890S

Follow the procedure below to make settings for connecting to TS-890S.

After starting the ARCP-890, select "Settings" in the "Tool" menu, then the "Settings" window opens.

Tips:

When ARCP-890 is started for the first time, the "Initial Setting" window opens and you can make settings for connecting to TS-890S.

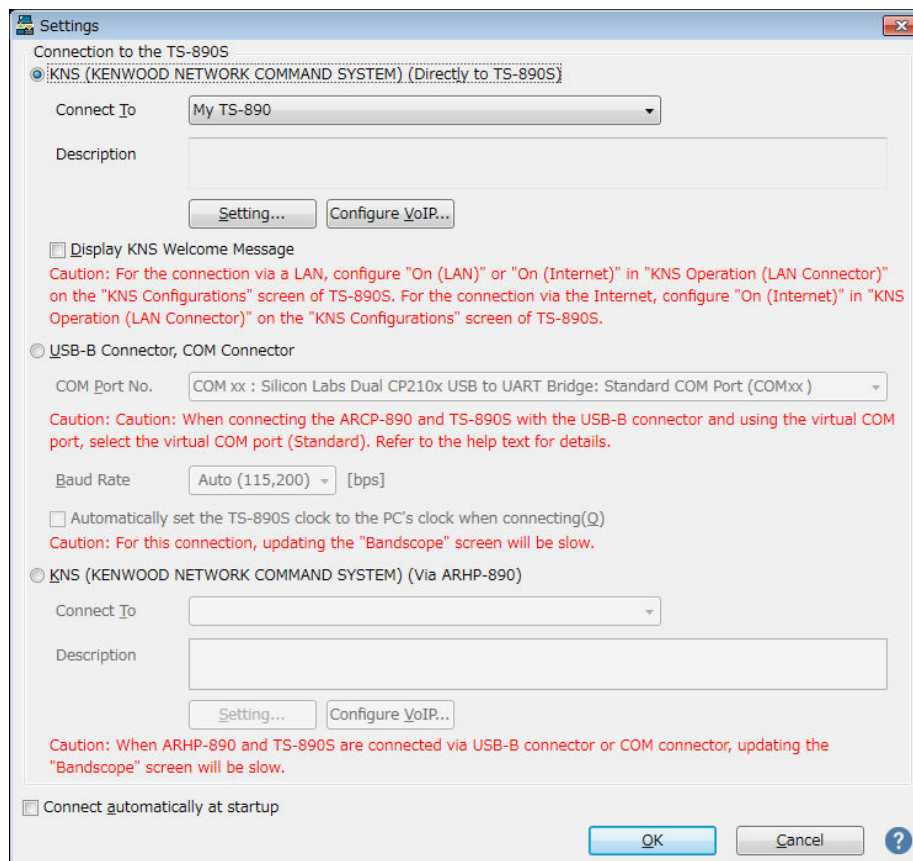

**Fig. 4.3: "Settings" window**

As shown in the above figure, select "KNS (KENWOOD NETWORK COMMAND SYSTEM) (Directly to TS-890S)" in "Connection to TS-890S".

Next, to set the information such as the IP address of the TS-890S of the connection destination, click "Setting" button. The "Configure KNS (Directly to TS-890S) Connection" window below opens.

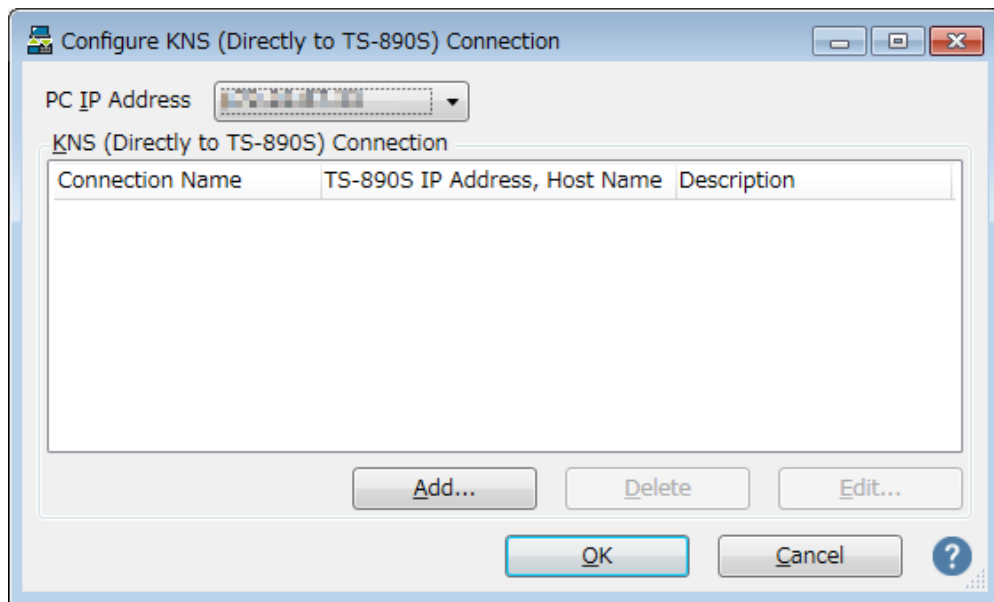

**Fig. 4.4: "Configure KNS (Directly to TS-890S) Connection" window**

Click the "Add" button to add the desired TS-890S to the connection destination list. The following "Edit KNS (Directly to TS-890S) Connection" window opens.

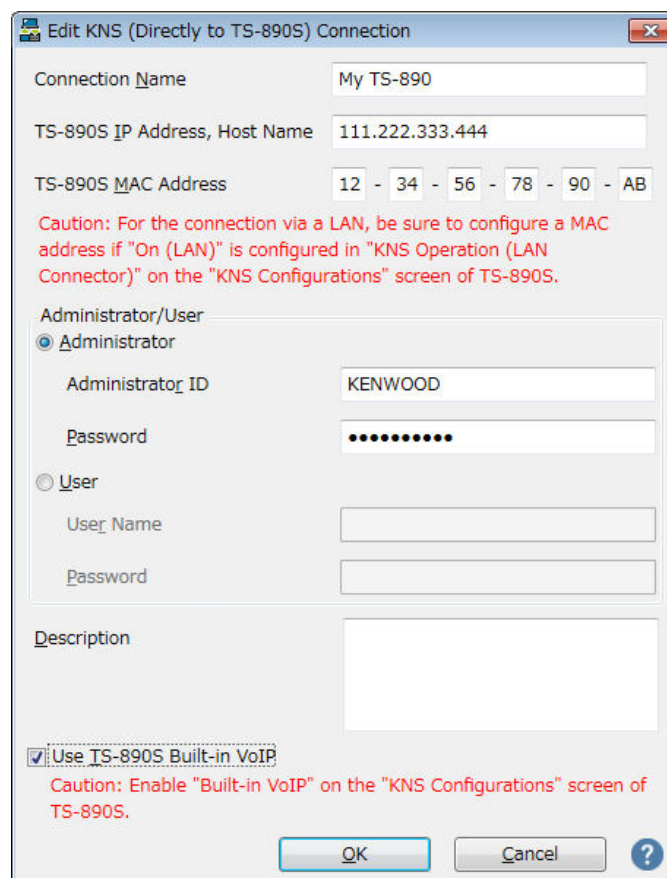

**Fig. 4.5: "Edit KNS (Directly to TS-890S) Connection" window**

Enter an arbitrary name for "Connection Name".

For "TS-890S IP Address, Host Name", enter the global IP address of the TS-890S confirmed in chapter "4.2.11. Confirming the global IP address".

Leave the "TS-890S MAC Address" blank and do not enter it.

If you are the administrator of the TS-890S that you operate remotely, select "Administrator" and enter "Administrator ID" and "Password". For details about the administrator, please refer to chapter "4.2.1. Administrator settings".

If you are a KNS user of the TS-890S that you operate remotely, select "User" and enter "User Name" and "Password". For details about KNS users, see chapter "4.2.2. Registering KNS Users".

In "Description", if there are several TS-890S to be operated remotely, etc., fill in the information on installation location etc. It does not matter without filling in.

Check "Use TS-890S Built-in VoIP".

Finally clicking the "OK" button closes the "Edit KNS (Directly to TS-890S) Connection" window and returns to the "Configure KNS (Directly to TS-890S) Connection" window.

Make sure that the edited information has been added to the connection list.

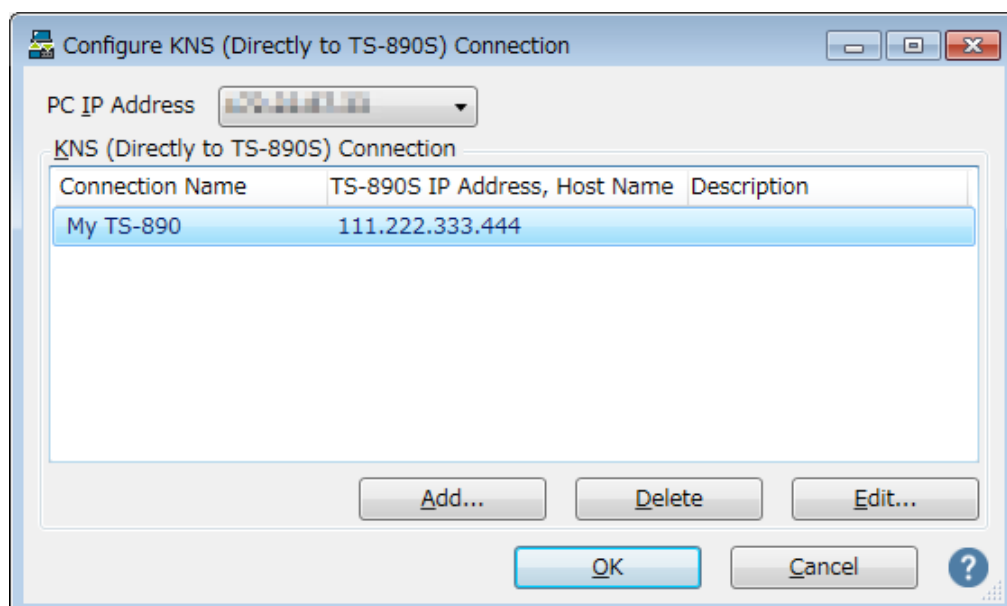

**Fig. 4.6: The connection list after adding the destination**

If you modify, select the connection destination to be modified, click the "Edit" button, open the "Edit KNS (Directly to TS-890S) Connection" window again and modify it.

Select the PC's IP address at "PC IP Address". If there are multiple IP addresses on the PC to be used, select the IP address to be used for connection with the TS-890S.

Clicking the "OK" button closes the "Configure KNS (Directly to TS-890S) Connection" window and returns to the "Setting" window in Figure 4.3.

Check the "Connect To" in the "Settings" window. If more than one connection destination is registered, select from the drop-down list.

Click the "OK" button to close the "Settings" window.

#### 4.3.4. Sound device selection and VoIP setting

Select speaker and microphone to be used by remote control and make various settings of VoIP. When you select "Setting" in "Tools" menu of ARCP-890, "Setting" window opens. (See Figure 4.3 Settings window)

Click the "Configure VoIP" button. The "Configure VoIP" window opens.

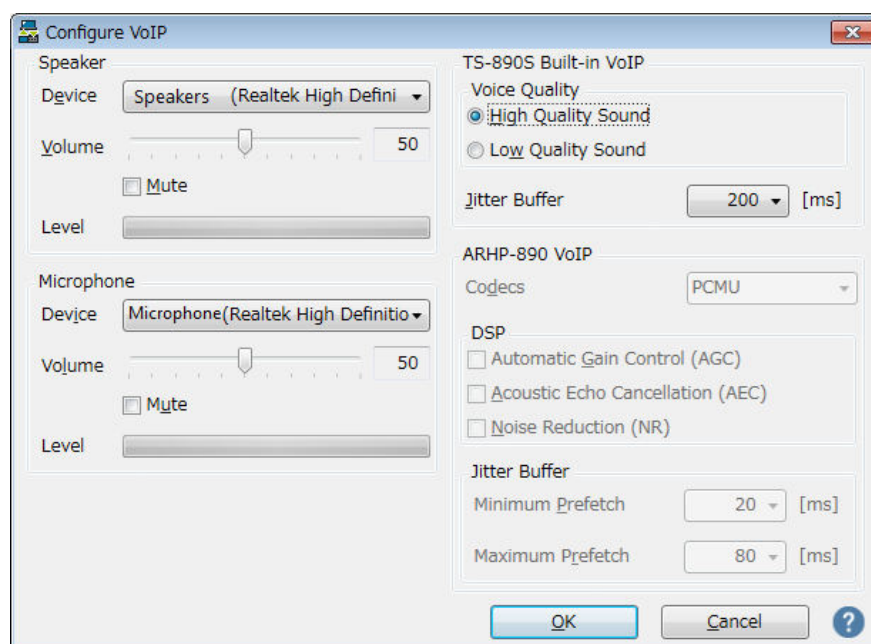

Fig. 4.7: "Configure VoIP" window

Select the speaker and microphone to use from the drop-down list.

Next, set "Voice quality" of "TS-890S Built-in VoIP". The default is "High Quality Sound". If the sound is interrupted frequently or the connection with the TS-890S is disconnected during operation, switch to "Low Quality Sound".

Next, set "fluctuation absorption buffer". The default is "80 ms". Adjust this item when there is a problem with the voice quality of VoIP. Selecting a shorter time reduces the audio delay but noise is more likely to occur due to missing audio packets or the like. Selecting a longer time increases the audio delay but noise occurrence due to missing audio packets or the like is potentially reduced. Set the value as small as possible within a range that does not affect the operation.

After setting, click "OK" button and close "Configure VoIP" window.

Tips:

Depending on the OS used on the PC, clicking the "VoIP setting" button may open the "Windows Security Alert" window. Click "Allow access" to advance the setting.

(For details on this window display, see "4.5.1. Windows Firewall Settings")

#### **4.3.5. Connection and disconnection to TS-890S**

When you click the "Connect" button in the main window of ARCP-890, the indicator will light green and communication with the TS-890S will start. You can disconnect by clicking the "Connect" button during connection.

#### **4.3.6. Setting TX Operation for use in ARCP-890 and checking modulation line**

Set whether the transmission operation from ARCP-890 corresponds to SEND/PTT operation of the TS-890S or DATA SEND operation. In order to operate with the contents set in TS-890S in the chapter "4.2.9. Configuration of the Input Path of TX Audio", set "DATA SEND" for TX operation for use in ARCP-890.

When you are connected to the TS-890S and selecting "Select Modulation Line" from the

"TX/RX" menu of ARCP-890, the "Select Modulation Line" window will be displayed.

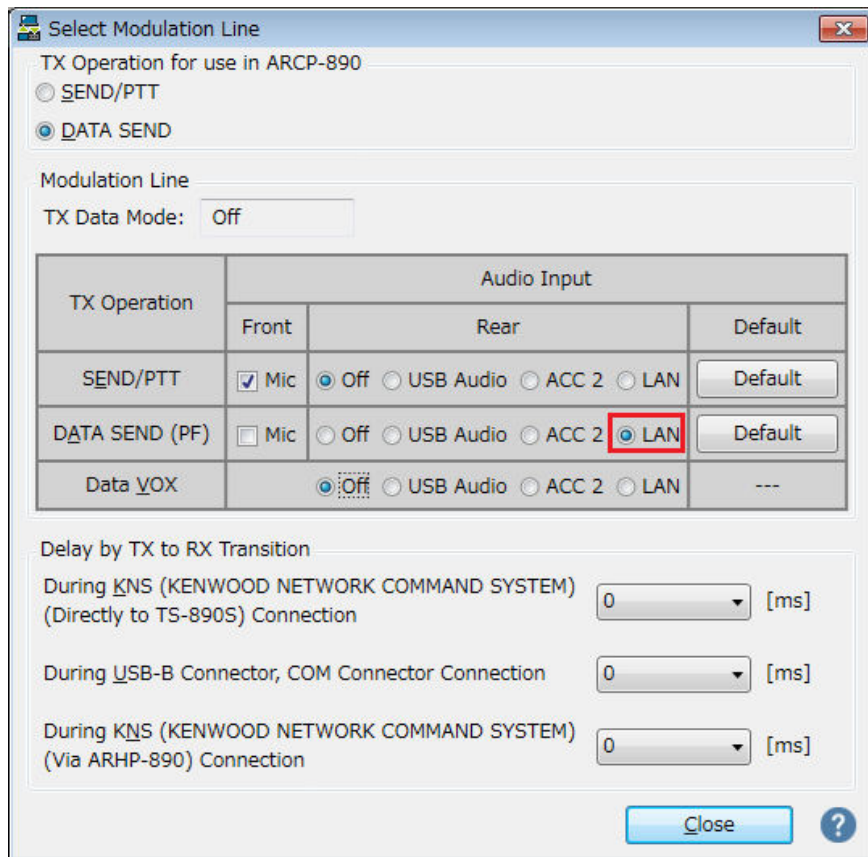

**Fig. 4.8: "Select Modulation Line" window**

As shown in the above figure, select "DATA SEND" for "TX Operation for use in ARCP-890".

For the setting of the modulation line, the contents set in TS-890S are displayed as they are in the chapter "4.2.9. Configuration of the Input Path of TX Audio". As shown in the figure above, when sending by DATA SEND (PF), make sure "LAN" is selected for audio input from rear panel.

After setting and checking, click the "Close" button to close the window.

#### 4.3.7. Setting the delay by TX to RX transition

When remote control is performed by Internet connection, the last part of the transmitted voice may be interrupted at the end of transmission. This is due to delay in voice transmission by VoIP.

In order to prevent this, it is possible to delay the timing of switching from transmission to



reception when performing the transmission end operation with ARCP-890.

When you are connected to the TS-890S and selecting "Select Modulation Line" from the "TX/RX" menu of ARCP-890, the "Select Modulation Line" window will be displayed.

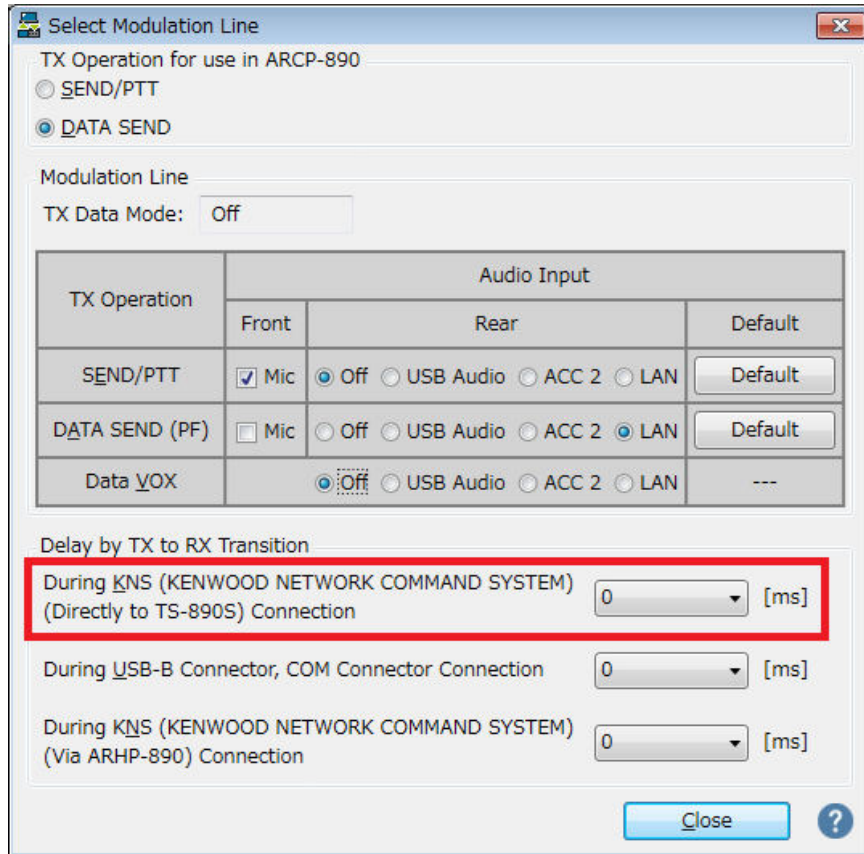

**Fig. 4.9: Set point of "Delay by TX to RX Transition"**

Select the delay time of "During KNS (KENWOOD NETWORK COMMAND SYSTEM) (Directly to TS-890S) Connection" from the drop-down list. After setting, click the "Close" button to close the "Select Modulation Line" window.

#### 4.4. Network settings for remote control by Internet connection

##### 4.4.1. Required network environment

The network environment required for each of the host station and the remote station when remotely operating with the Internet connection is as follows.

**Table 4.10 Required network environment**

Network environment	<ul style="list-style-type: none"> <li>• A broadband router capable of setting port forwarding is required. *1</li> <li>• Firewall environments configured using in-house company networks</li> </ul>
---------------------	---

	cannot be used. Use a home LAN environment.
Internet environment	<ul style="list-style-type: none"> <li>· A high-speed wired broadband environment using xDSL, FTTH, or CATV network is required. (1Mbps min. recommended.)</li> <li>· It is necessary to be able to use the protocols (TCP and UDP) and ports used for remote control of the TS-890S. *2</li> <li>· A global IP address is required. *2, *3</li> <li>· A proxy server cannot be used.</li> </ul>

\*1: Refer to the user manual for the broadband router to be used before performing the settings.

\*2: For details, contact your internet service provider.

\*3: Remote operations are possible even if the global IP address is variable, but the IP address may change with uncertain timing. In such cases, it is necessary to check and change the IP address of the connected host when connected from a remote station, which reduces user-friendliness. Consequently, using an environment in which the host station global IP address is fixed, is recommended. Furthermore, if the global IP address cannot be fixed, using a dynamic DNS service enables operations in the same way as an environment with a fixed global IP address.

#### 4.4.2. Broadband router settings

In order to pass control data and audio data for remote control between the Internet and the home LAN, set "port forwarding" to the broadband router.

This setting depends on the call method of the broadband router manufacturer, and may be "Port forwarding", "IP masquerade", "Port conversion", "NAT address conversion", etc. Refer to the user manual for the broadband router used.

- Settings for the broadband router at the host station  
Set the following to the host station's broadband router.

Port forwarding for control data

Item(Example)	Setting Details
Open IP address	IP address of the TS-890S
Protocol	TCP
Port Number	60000
Direction	Two-way

#### Port forwarding for audio data

Item(Example)	Setting Details
Open IP address	IP address of the TS-890S
Protocol	UDP
Port Number	60001
Direction	Two-way

- Settings for the broadband router at the remote station

Set the following to the remote station's broadband router.

#### Port forwarding for audio data

Item(Example)	Setting Details
Open IP address	IP address of the PC running ARCP-890
Protocol	UDP
Port Number	60001
Direction	Two-way

#### Caution:

- For the broadband router settings, refer to the broadband router user manual.
- Incorrect broadband router settings may stop the network or enable illegal external access to the network. Take thorough precautions when changing the settings.
- JVC KENWOOD Corporation does not offer support for customer PCs and networks.

## 4.5. PC settings for remote operation by Internet connection

### 4.5.1. Windows Firewall settings

At the time ARCP-890 accesses the VoIP function for the first time, the OS may open a "Windows Security Alert" window.

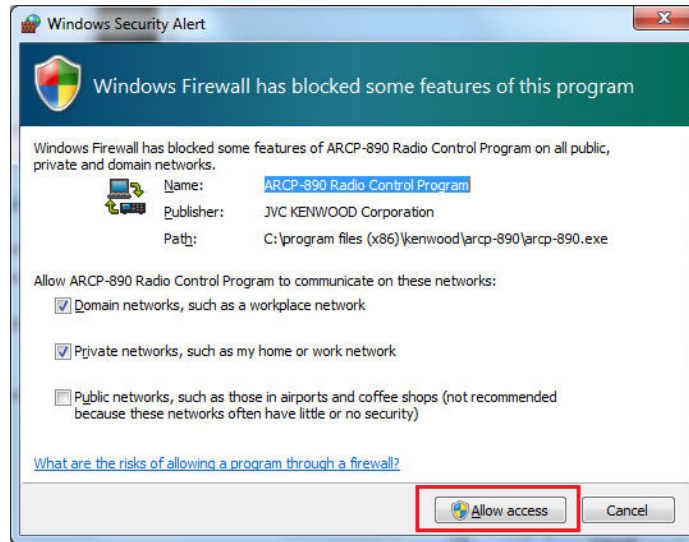

**Fig. 4.10: Windows Firewall Settings**

Click "Allow Access" to allow access to control command data communication and voice data communication of ARCP-890.

Tips:

Normally, if you do the above operation, it will not be warned during the use of ARCP-890 after that. If the warning is displayed again while using ARCP-890, add the setting to allow ARCP - 890 communication in the Windows Firewall setting in the control panel.

#### **4.5.2. Settings for integrated security software**

When using integrated security software, it is necessary to set it so as not to disturb ARCP - 890 communication. Please refer to the instruction manual of your integrated security software and set it.

## 5. Remote operation via the Internet by conventional system

When remotely operating the TS-890S via the Internet, the system described in Chapter 4 uses the VoIP function and the user's login authentication function built in the TS-890S. In this system, the TS-890S is connected directly to the Internet, but you can also select a conventional system connecting the TS-890S to the Internet via a PC (Host PC) installed in the host station. In this conventional system, ARHP-890 (Radio Host Program) and ARVP-10 (VoIP software) are required.

### 5.1. Conventional System Configuration

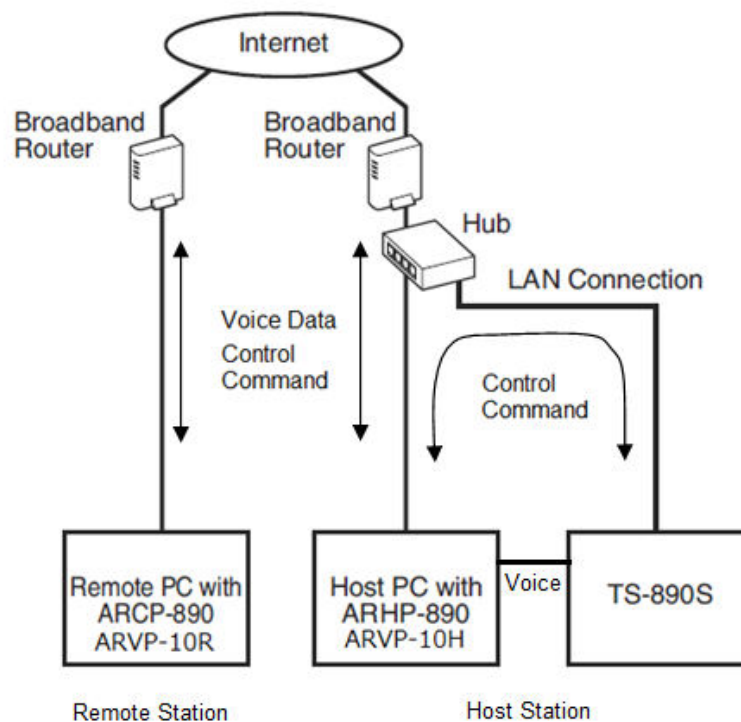

**Fig. 5.1: Conventional System Configuration**

As shown in the above figure, prepare the PC (Host PC) on the host station side and use ARHP-890.

Since the VoIP function built into the ARHP-890 does not support remote control by Internet connection, we use ARVP-10 of VoIP software. ARVP-10H is used on the host PC and ARVP-10R is used on the remote PC.

\* Other VoIP software can be used in place of ARVP-10, but our selection of VoIP software, installation, setting and operation are not supported by JVC KENWOOD Corporation.

Connect TS-890S and the host PC with analog audio cable. To connect the PC's audio output line to pin 11 (ANI) of the ACC 2 connector and PC audio input line to pin 3 (ANO) of the ACC 2 connector, make the connection cable referring to the figure below.

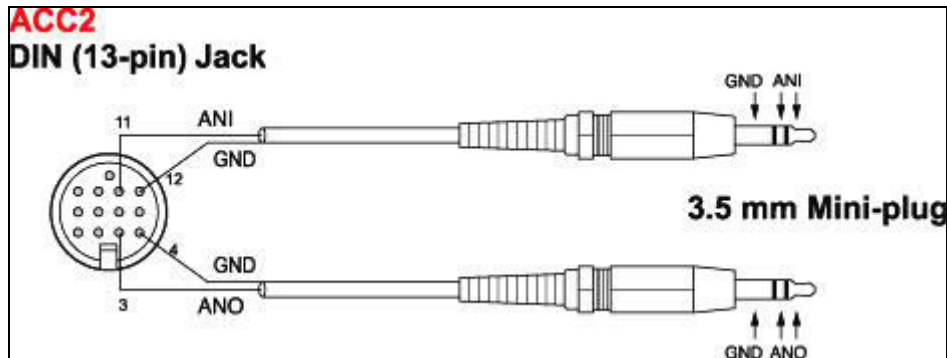

**Fig. 5.2: Wiring method of the audio cable**

## 5.2. TS-890S settings in conventional system

### 5.2.1. Administrator settings

Set the following items in KNS menu. For the operation method, refer to the operation manual of the TS-890S.

**Table 5.1 Administrator settings**

KNS Menu	Item
1	Administrator ID
2	Administrator Password

### 5.2.2. Settings the built-in VoIP(to turn OFF)

In the KNS menu, set the built-in VoIP function to "Off". For the operation method, refer to the operation manual of the TS-890S.

**Table 5.2 Setting the built-in VoIP**

KNS Menu	Item
3	Built-in VoIP

### 5.2.3. Setting Speaker Mute

If you want to mute the sound output from the TS-890S speaker during remote operation, set the speaker mute to "On" in the KNS menu. For the operation method, refer to the operation manual of the TS-890S.

**Table 5.3 Setting Speaker Mute**

KNS Menu	Item
7	Speaker Mute

### 5.2.4. Configuration for KNS Operation

In the KNS menu of the TS-890S, set KNS operation (LAN connector) to "On (Internet)". For the operation method, refer to the operation manual of the TS-890S.

**Table 5.4 Configuration for KNS Operation**

KNS Menu	Item
1	KNS Operation(LAN Connector)

### 5.2.5. Timeout timer settings

During KNS operations, control data signals are transmitted using the network. Consequently, if normal network operations are disabled for any reason, control of the TS-890S will also be disabled. Use the following menu to set the functions to stop transmitting automatically after a fixed period if control should be disabled while transmitting.

**Table 5.5 Timeout timer settings**

Menu	Item
6-02	Time-out Timer

### 5.2.6. Configuration the Input Path of TX Audio

In the case of using the audio cable, the audio for transmission is input from the ACC 2 connector. In order to transmit audio from the ACC 2 connector by the transmission operation from the ARCP-890, set the DATA SEND audio input from the rear panel to "ACC 2" on the "Modulation Source" screen of the TS-890S. (See the screen below)

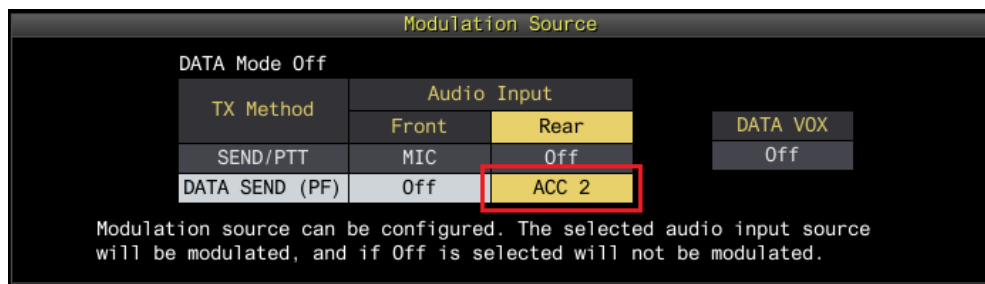

**Fig. 5.3: Configuration the Input Path of TX Audio**

Also, in order to prevent unintentional transmission during remote control by KNS, set DATA VOX normally select "Off".

(Note) The "Modulation Source" screen shown in Figure 5.3 can be set separately for DATA mode Off and DATA mode On. Please set according to the operation mode.

### 5.2.7. Setting the ACC 2 audio input / output level

In the case of using the audio cable, set the audio input level and the audio output level of the ACC 2 connector on the rear panel with the menu. You use default values normally. Adjust the input level of the microphone connected to the PC and the output level of the speaker, in the setting of the sound device of the PC of the remote station. If it can not be adjusted with the PC, adjust with the menu of the TS-890S. For the operation method, refer to the operation manual of the TS-890S.

**Table 5.6 Setting the audio Input/Output level**

Menu	Item
7-7	ACC 2: Audio Input Level
7-9	ACC 2: Audio Output Level

### 5.2.8. Setting beep mixed output

With the TS-890S default mode, the audio output from the ACC 2 connector and the USB connector is not only the received sound, but also beeps and side tones are mixed. The following menu can be used to prevent beep sound and side tone from being mixed with the audio output of ACC 2 connector and USB connector.



**Table 5.1 Setting beep mixed output**

Menu	Item
7-11	Audio Output Type (Rear Connectors)

### 5.2.9. Setting the TX monitor level

The level of the TX monitor output from the ACC 2 connector and the USB connector can be linked with the value set by the TX monitor function or it can be set to an independent and fixed value. Normally, in remote operation, please use the initial value Linked.

**Table 5.2 Setting the TX monitor level**

Menu	Item
7-10	TX Monitor Level (Rear Connectors)

### 5.2.10. Setting and confirming the IP address

Set the IP address required to communicate with the ARHP-890. The IP address setting includes automatic setting (using DHCP) and manual setting.

The IP address is set in the LAN menu of the TS-890S. For the operation method, refer to the operation manual of the TS-890S.

When configuring the ARHP-890, there is a place to enter the IP address of the TS-890S, so confirm the IP address you set here.

## 5.3. ARHP-890 settings in conventional system

### 5.3.1. PC operating environment

When operating remotely via Internet connection, the operating environment required for the PC running ARHP-890 is as follows.

**Table 5.9 PC operating environment**

Operating System (OS)*	Windows 10 (version 1703 (OS Build 15063.0) or later, 32-bit or 64-bit version)
------------------------	---

	Windows 8.1 (RTM or later, 32-bit or 64-bit version) Windows 7 (Service Pack 1 or later, 32-bit or 64-bit version)
Processor	Faster than the recommended CPU for OS on which you are operating
System Memory (RAM)	RAM having the System Memory recommended by the respective OS used in your PC or larger
Free Hard Disk Space	100 MB or more of free hard disk space
Software	Microsoft .NET Framework 4.7 (including .NET Framework 4.0)
Peripheral Devices	Displays with resolutions higher than SXGA (1280 x 1024) Keyboard, mouse or other pointing devices USB 2.0 port or RS-232C interface Network function Available networking environment (LAN or high-speed broadband) Sound function and audio input/output device

\* Applicable operating systems are subject to change without notice due to the end of the technical support by Microsoft Corporation or change of the product specifications.

### 5.3.2. Installing ARHP-890

Download and install the ARHP-890 to the PC from the KENWOOD website:  
[http://www.kenwood.com/i/products/info/amateur/software\\_download.html](http://www.kenwood.com/i/products/info/amateur/software_download.html)  
 For the installation method, refer to the guide on the download page.

### 5.3.3. Settings for connecting to TS-890S

Follow the procedure below to make settings for connecting to TS-890S.

After starting the ARHP-890, select "Settings" in the "Tool" menu, then the "Settings" window opens.

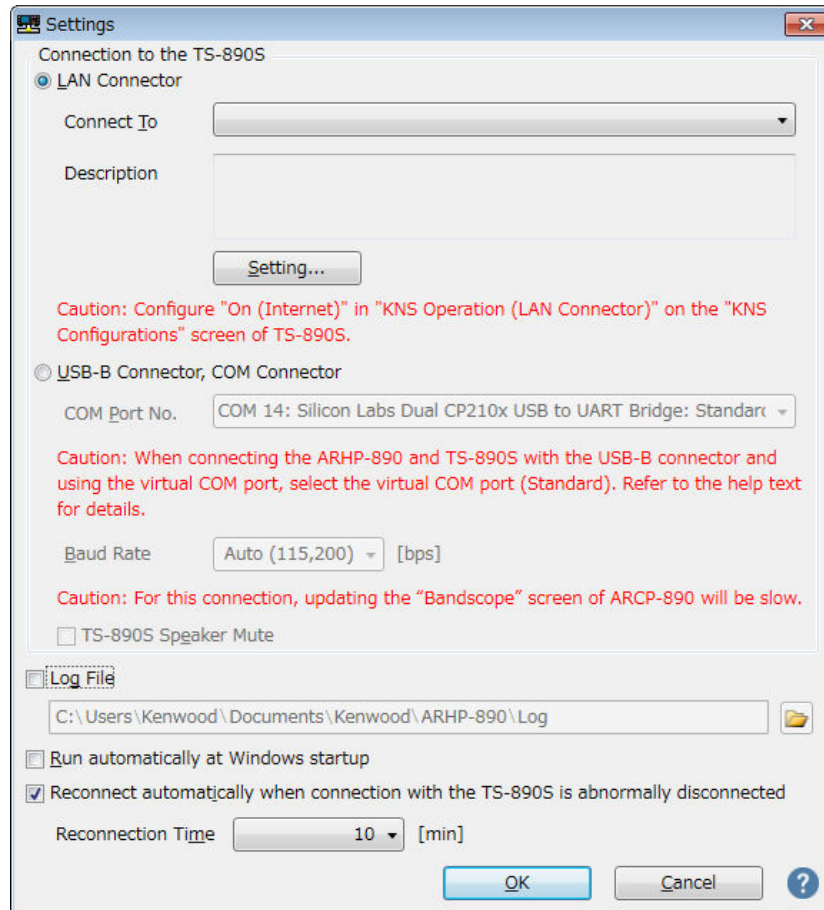

**Fig. 5.4: "Settings" window**

As shown in the above figure, select "LAN Connector" in "Connection to TS-890S".

Next, to set the information such as the IP address of the TS-890S of the connection destination, click "Setting" button. The "Configure LAN Connection" window opens.

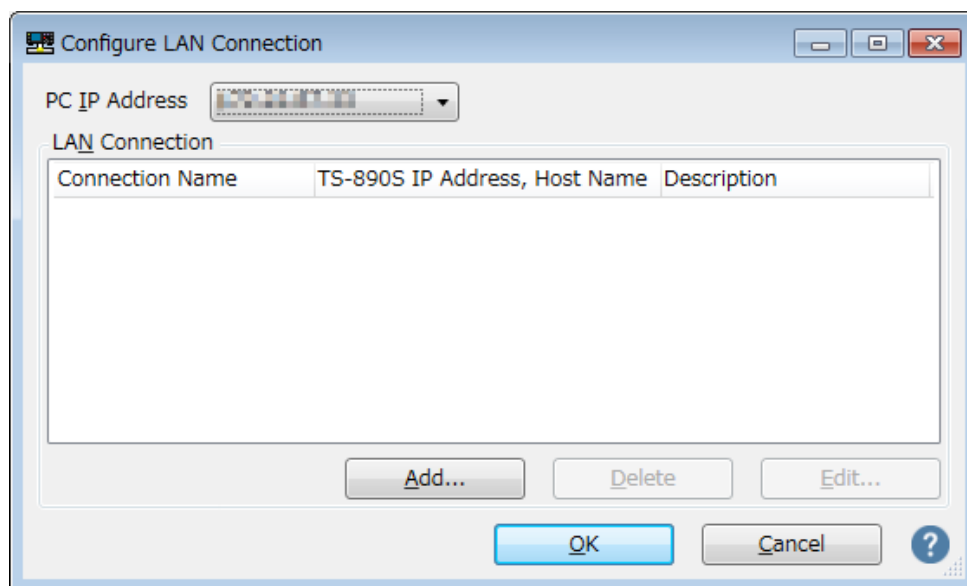

**Fig. 5.5: "Configure LAN Connection" window**

Select the PC's IP address at "PC IP Address". If there are multiple IP addresses on the PC to be used, select the IP address to be used for connection with the TS-890S.

Click the "Add" button to add the desired TS-890S to the connection destination list. The following "Edit LAN Connection" window opens.

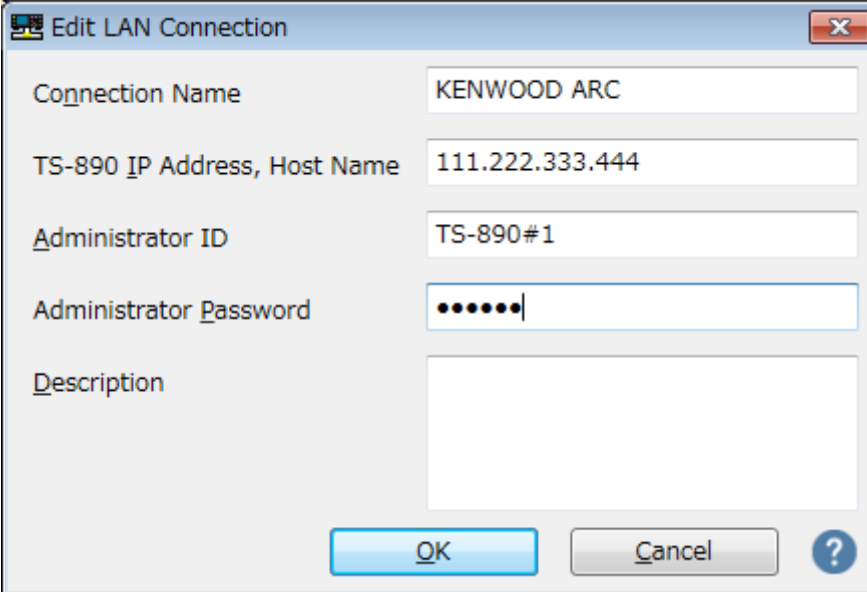

Connection Name	KENWOOD ARC
TS-890 IP Address, Host Name	111.222.333.444
Administrator ID	TS-890#1
Administrator Password	•••••••
Description	

**Fig. 5.6: "Edit LAN Connection" window**

Enter an arbitrary name for "Connection Name".

For "TS-890S IP Address, Host Name", enter the IP address of the TS-890S confirmed in chapter "5.2.10 Setting and confirming the IP address".

Enter "Administrator ID" and "Password" set in chapter "5.2.1. Administrator Settings".

In "Description", if there are several TS-890S to be operated remotely, etc., fill in the information on installation location etc. It does not matter without filling in.

Finally clicking the "OK" button closes the "Edit LAN Connection" window and returns to the "Configure LAN Connection" window.

Make sure that the edited information has been added to the connection list.

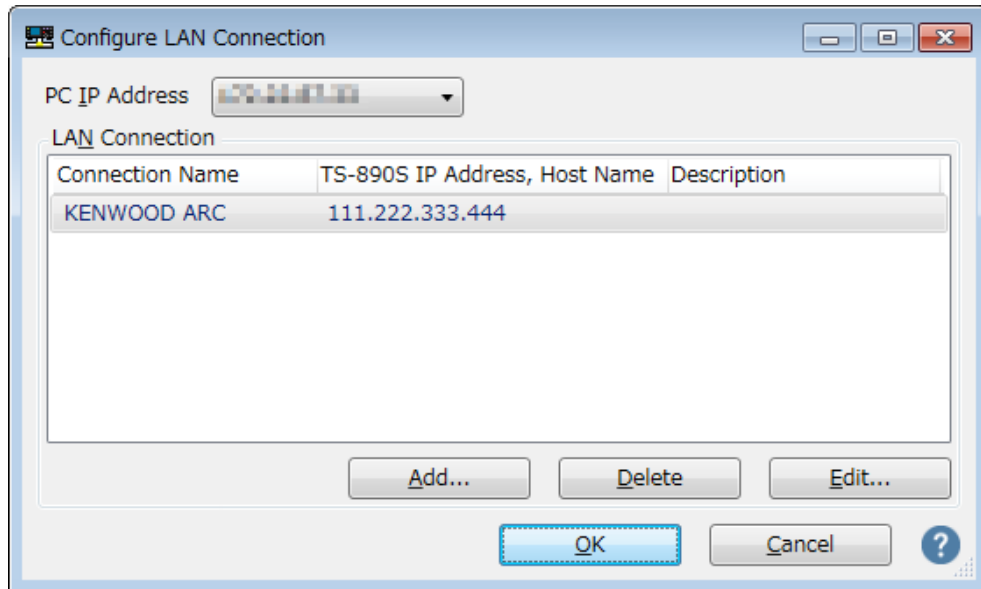

**Fig. 5.7: The connection list after adding the destination**

If you modify, select the connection destination to be modified, click the "Edit" button, open the "Edit LAN Connection" window again and modify it.

Select the PC's IP address at "PC IP Address". If there are multiple IP addresses on the PC to be used, select the IP address to be used for connection with the TS-890S.

Clicking the "OK" button closes the "Configure LAN Connection" window and returns to the "Setting" window in Figure 5.4.

Check the "Connect To" in the "Settings" window. If more than one connection destination is registered, select from the drop-down list.

Click the "OK" button to close the "Settings" window.

#### 5.3.4. Setting KNS

Follow the procedure below to configure the remote station user to connect to the TS-890S via the ARHP-890 from the Internet.

When you select "Configure KNS" in "Tools" menu of ARHP-890, "Configure KNS" window opens.

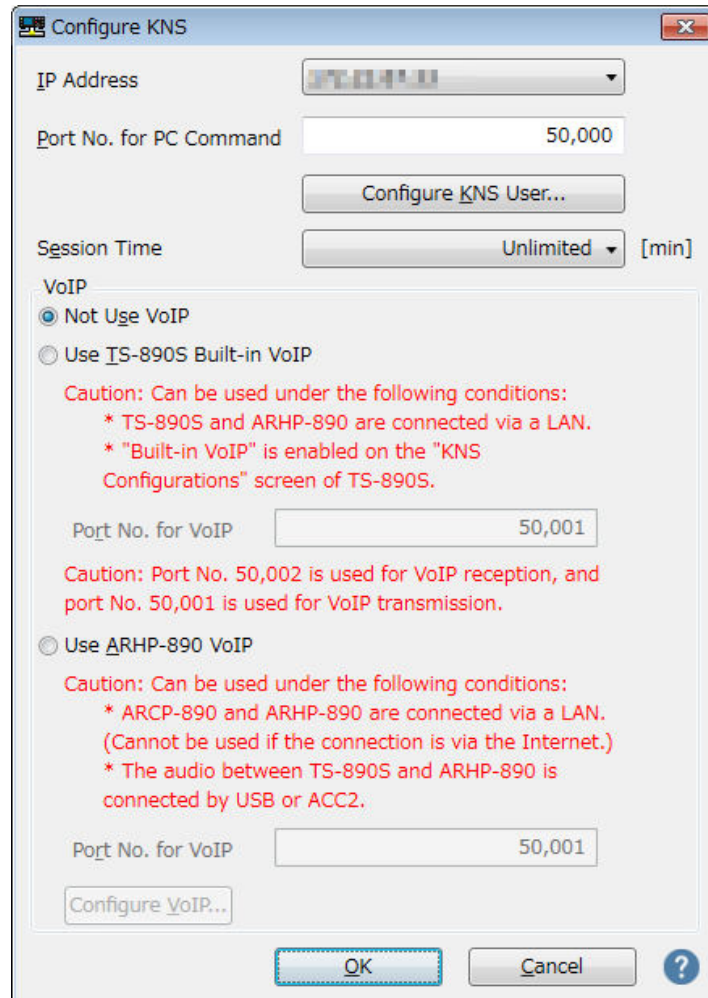

**Fig. 5.8: "Configure KNS" window**

Select the PC's IP address at "PC IP Address". If there are multiple IP addresses on the PC to be used, select the IP address to be used for connection with the broadband router.

For "Port No. for PC command", set the port number used for PC command communication. Normally, please use the default value.

For "Session time", set the maximum connection time for remote operation.

In "VoIP" setting, select "Not use VoIP" because built-in VoIP is not used when using ARVP-10.

Click the "Configure KNS User" button to register the user accessing TS-890S from a remote station. The "Configure KNS User" window opens.

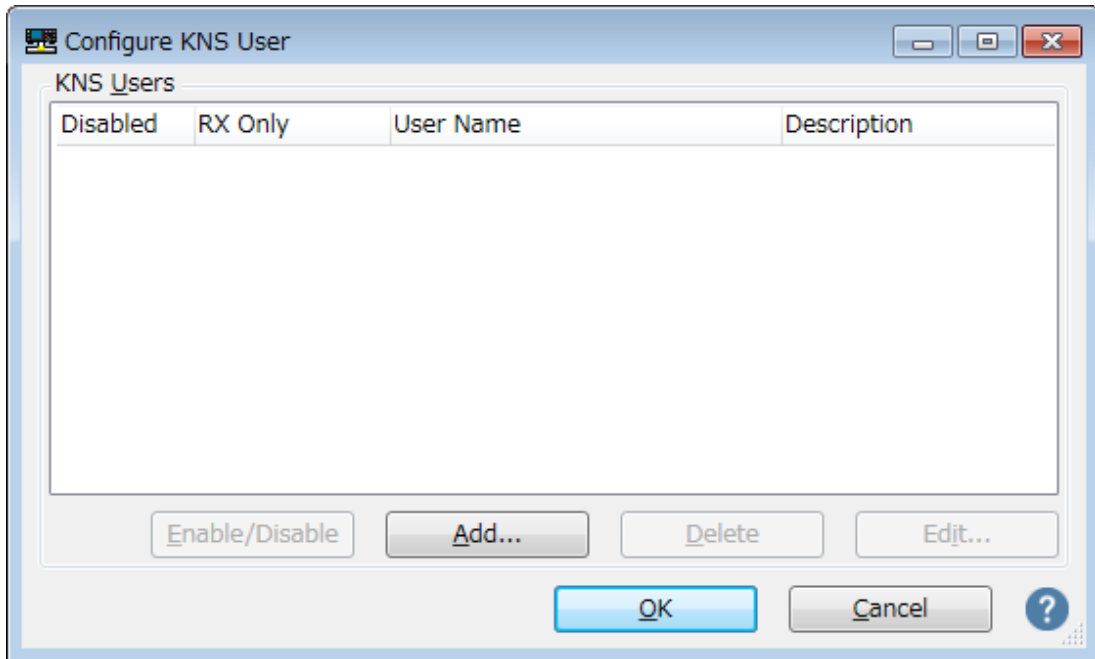

**Fig. 5.9: "Configure KNS User" window**

Click the "Add" button. The "Edit KNS User" window opens.

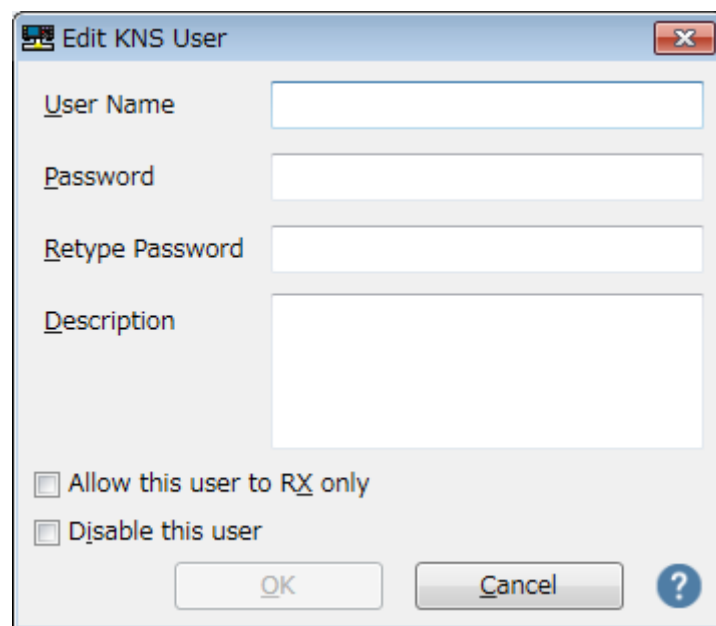

**Fig. 5.10: "Edit KNS User" window**

Enter "User Name", "Password", "Retype Password" and "Description".

"Description" will enter a description about the user (optional).

To allow this user to receive only the reception, check "Allow this user to RX only".

If you want to temporarily disable access from this user, check "Disable this user".

Finally clicking the "OK" button closes the "Edit KNS User" window and returns to the "Configure KNS User" window.

Make sure that the edited information has been added to the list.

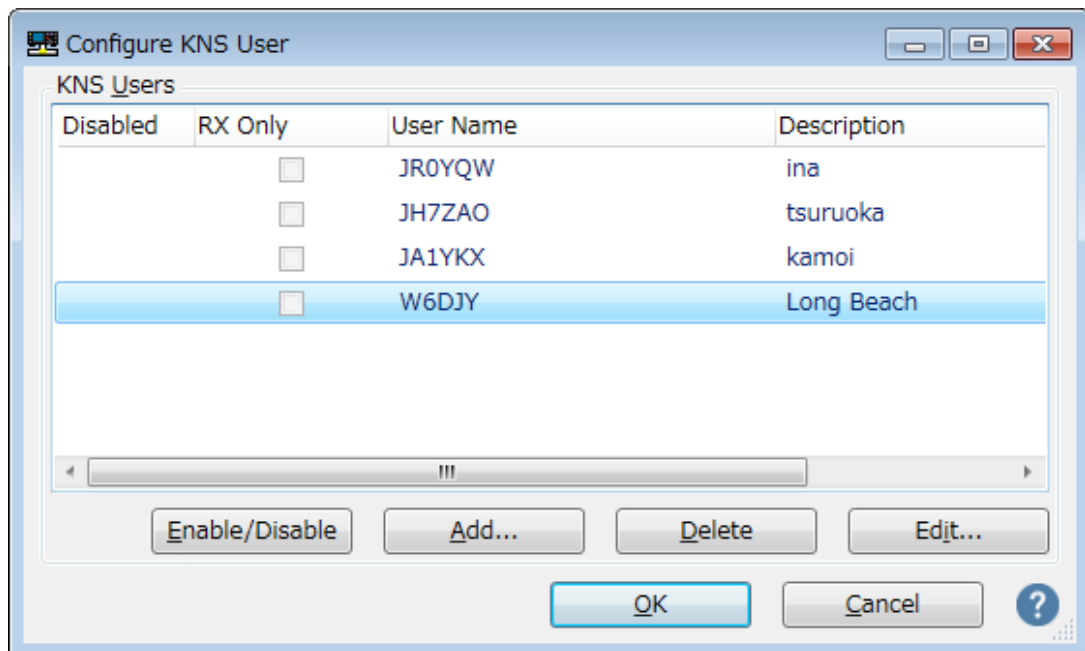

**Fig. 5.11: The KNS user list after adding user**

If you modify, select the user to be modified, click the "Edit" button, open the "Edit KNS User" window again and modify it.

Click the "OK" button to close the "Configure KNS User" window and return to the "Configure KNS" window.

### 5.3.5. Connection and disconnection to TS-890S

When you click the "Connect" button in the main window of ARHP-890, the indicator will light green and the ARHP-890 connects to TS-890S and starts communication. You can disconnect by clicking the "Connect" button during connection.

Tips:

Depending on the OS used on the PC, clicking the "Connect" button may open the "Windows Security Alert" window. Click "Allow access" to advance the setting.

(For details on this window display, see chapter "5.7.1. Windows Firewall Settings")



### 5.3.6. Confirming the IP address

Since the IP address of the PC is required when setting up the host station 's broadband router, confirm the IP address in advance.

The IP address of the PC can be confirmed with ARHP-890. Refer to the chapter "5.3.3. Settings for connecting to TS-890S". You can confirm by "PC IP address" displayed in the "Configure LAN Connection" window in Figure 5.5.

### 5.3.7. Confirming the global IP address

Since the global IP address of host station side is required when setting up the remote station's ARCP-890, confirm the global IP address in advance. The global IP address is managed by the internet service provider. Ask your internet service provider or check the global IP address that your broadband router is acquiring. (Please refer to the instruction manual of Broadband Router etc.)

## 5.4. ARCP-890 settings in conventional system

### 5.4.1. PC operating environment

When operating remotely via Internet connection, the operating environment required for the PC running ARHP-890 is as follows.

**Table 5.10 PC operating environment**

Operating System (OS)*	Windows 10 (version 1703 (OS Build 15063.0) or later, 32-bit or 64-bit version) Windows 8.1 (RTM or later, 32-bit or 64-bit version) Windows 7 (Service Pack 1 or later, 32-bit or 64-bit version)
Processor	Faster than the recommended CPU for OS on which you are operating
System Memory (RAM)	RAM having the System Memory recommended by the respective OS used in your PC or larger
Free Hard Disk Space	100 MB or more of free hard disk space
Software	Microsoft .NET Framework 4.7 (including .NET Framework 4.0)

Peripheral Devices	Displays with resolutions higher than SXGA (1280 x 1024) Keyboard, mouse or other pointing devices USB 2.0 port or RS-232C interface Network function Available networking environment (LAN or high-speed broadband) Sound function and audio input/output device
--------------------	--

\* Applicable operating systems are subject to change without notice due to the end of the technical support by Microsoft Corporation or change of the product specifications.

#### 5.4.2. Installing ARCP-890

Download and install the ARCP-890 to the PC from the KENWOOD website:

[http://www.kenwood.com/i/products/info/amateur/software\\_download.html](http://www.kenwood.com/i/products/info/amateur/software_download.html)

For the installation method, refer to the guide on the download page.

#### 5.4.3. Settings for connecting to TS-890S

Follow the procedure below to make settings for connecting to TS-890S.

After starting the ARCP-890, select "Settings" in the "Tool" menu, then the "Settings" window opens.

Tips:

When ARCP-890 is started for the first time, "Initial setting" window opens automatically, you can make settings to connect to TS-890S in this window. The setting items are the same as those in the "Settings" window.

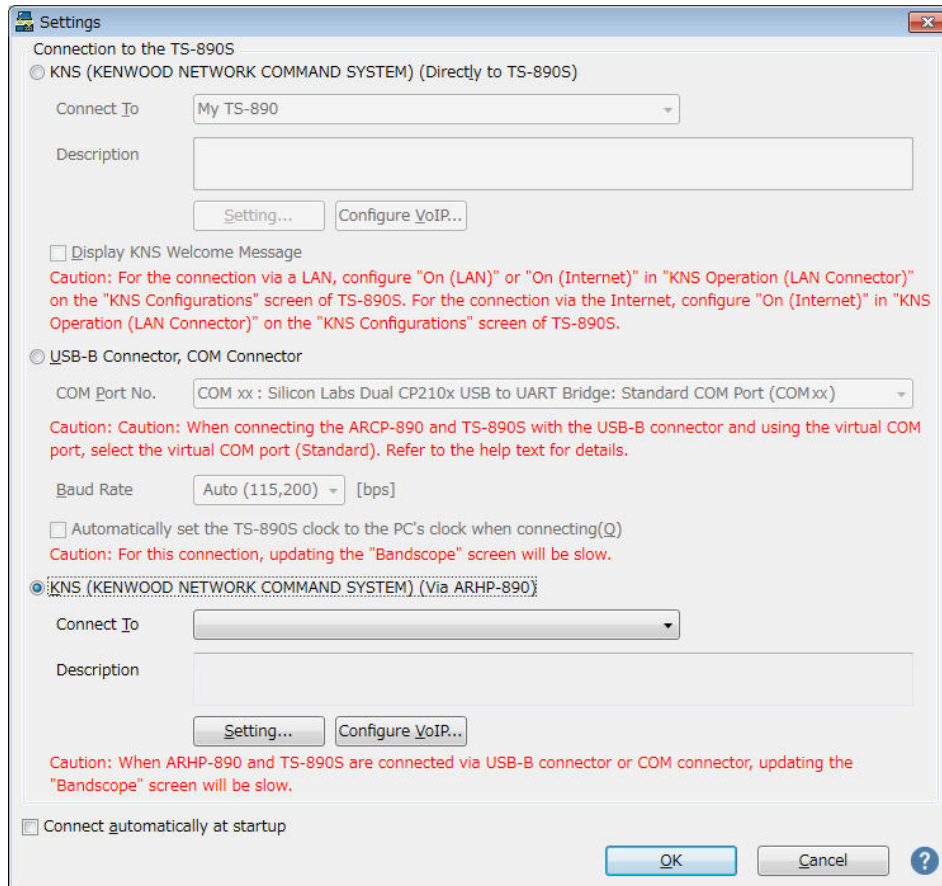

**Fig. 5.12: "Settings" Window**

As shown in the above figure, select "KNS (KENWOOD NETWORK COMMAND SYSTEM) (Via ARHP-890)" in "Connection to TS-890S".

Next, to set the information such as the IP address of ARHP-890 of the connection destination, click "Setting" button. The "Configure KNS (Via ARHP-890) Connection" window below opens.

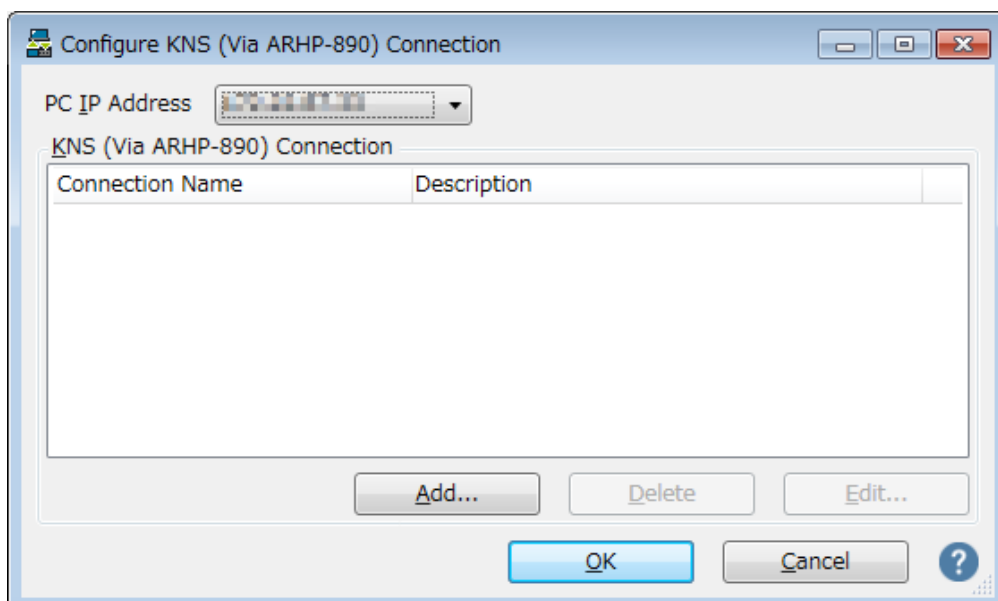

**Fig. 5.13: "Configure KNS (Via ARHP-890) Connection" window**

Click the "Add" button to add the desired ARHP-890(Host station) to the connection destination list. The following "Edit KNS (Via ARHP-890) Connection" window opens.

**Fig. 5.14: "Edit KNS (Via ARHP-890) Connection" window**

Enter an arbitrary name for "Connection Name".

For "ARHP-890 IP Address, Host Name", enter the global IP address of the host station confirmed in chapter "5.3.7 Confirming the global IP address".

For "ARHP-890 Port No. for PC command", enter the port number set at the "Port No. for PC command" in chapter "5.3.4. Setting KNS".

For "User Name" and "Password", enter the user ID and the password set at the "Edit KNS User" window in chapter "5.3.4. Setting KNS".

In "Description", if there are several TS-890S to be operated remotely, etc., fill in the information on installation location etc. It does not matter without filling in.

For VoIP setting, select "Not use VoIP".

Finally clicking the "OK" button closes the "Edit KNS (Via ARHP-890) Connection" window and returns to the "Configure KNS (Via ARHP-890) Connection" window.

Make sure that the edited information has been added to the connection list.

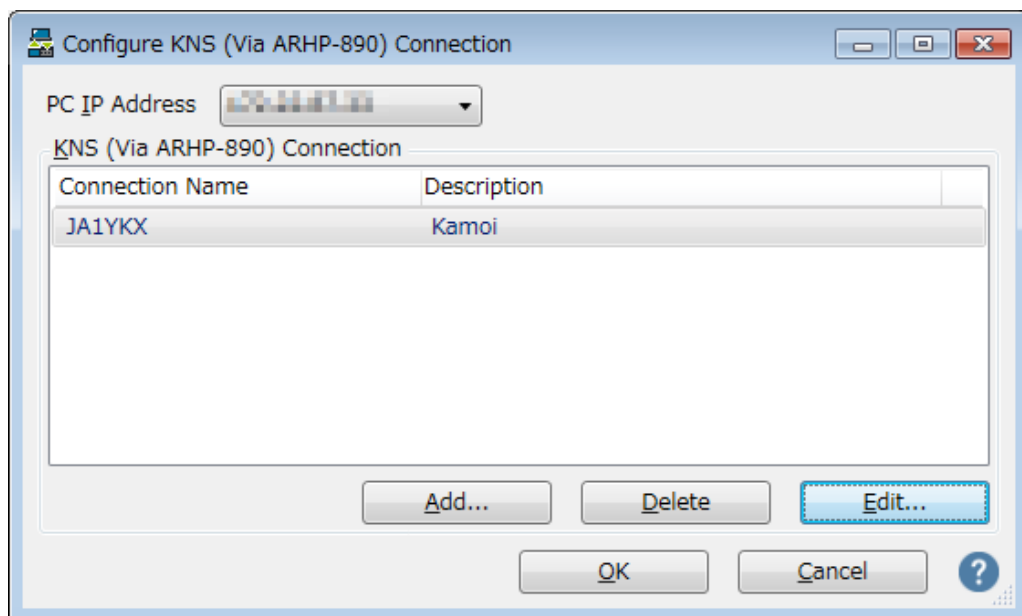

**Fig: 5.15: The connection list after adding the destination**

If you modify, select the connection destination to be modified, click the "Edit" button, open the "Edit KNS (Via ARHP-890) Connection" window again and modify it.

Select the PC's IP address at "PC IP Address". If there are multiple IP addresses on the PC to be used, select the IP address to be used for connection with the ARHP-890.

Clicking the "OK" button closes the "Configure KNS (Via ARHP-890) Connection" window and returns to the "Setting" window in Fig. 6.12.

Check the "Connect To" in the "Settings" window. If more than one connection destination

is registered, select from the drop-down list.

Click the "OK" button to close the "Settings" window.

#### 5.4.4. Connection and disconnection to TS-890S

When you click the "Connect" button in the main window of ARCP-890, the indicator will light green and communication with the TS-890S will start. You can disconnect by clicking the "Connect" button during connection.

Tips:

Depending on the OS used on the PC, clicking the "Connect" button may open the "Windows Security Alert" window. Click "Allow access" to advance the setting.

(For details on this window display, see chapter "5.7.1. Windows Firewall Settings")

#### 5.4.5. Checking modulation line

Connect to TS-890S and select "Select modulation line" in the "TX/RX" menu of ARCP-890. The "Select Modulation Line" window opens.

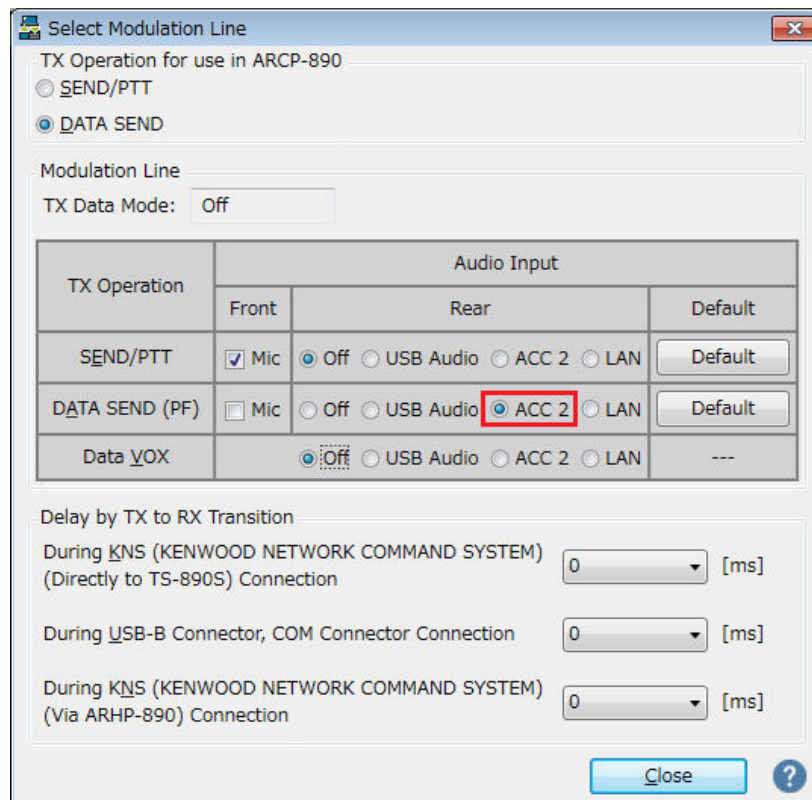

Fig. 5.16: "Select Modulation Line" window

As shown in the above figure, select "DATA SEND" for "TX Operation for use in ARCP-890".

For the setting of the modulation line, the contents set in TS-890S are displayed as they are in the chapter "5.2.6. Configuration of the Input Path of TX Audio". As shown in the figure above, when sending by DATA SEND (PF), make sure "ACC 2" is selected for audio input from rear panel.

After setting and checking, click the "Close" button to close the window.

#### **5.4.6. Setting the delay by TX to RX transition**

When remote control is performed by Internet connection, the last part of the transmitted voice may be interrupted at the end of transmission. This is due to delay in voice transmission by VoIP.

In order to prevent this, it is possible to delay the timing of switching from transmission to reception when performing the transmission end operation with ARCP-890.

When you are connected to the TS-890S and selecting "Select Modulation Line" from the "TX/RX" menu of ARCP-890, the "Select Modulation Line" window will be displayed.

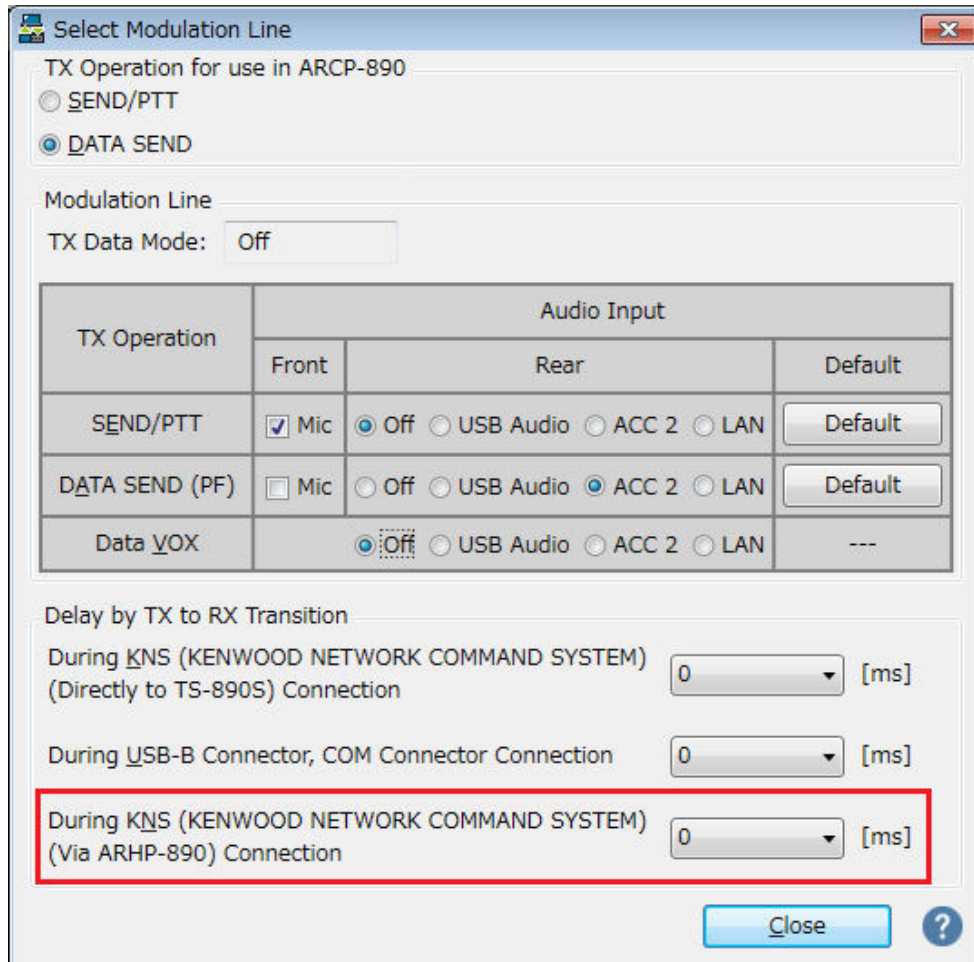

**Fig. 5.17: Set point of "Delay by TX to RX Transition"**

Select the delay time of "During KNS (KENWOOD NETWORK COMMAND SYSTEM) (Via ARHP-890) Connection" from the drop-down list. After setting, click the "Close" button to close the "Select Modulation Line" window.

## 5.5. Settings of ARVP-10 in conventional system

### 5.5.1. Installing ARVP-10

Download and install the ARVP-10 to the Host PC and the Remote PC from the KENWOOD website:

[http://www.kenwood.com/i/products/info/amateur/software\\_download.html](http://www.kenwood.com/i/products/info/amateur/software_download.html)

For the installation method, refer to the guide on the download page. ARVP-10H and ARVP-10R are installed on each PC.



### 5.5.2. Setting ARVP-10

At the remote station, start ARVP-10R. At the host station, start ARVP-10H.

Refer to the help of ARVP-10H and ARVP-10R for the setting method.

## 5.6. Network settings in conventional system

### 5.6.1. Required network environment

The network environment required for each of the host station and the remote station when remote control is performed via the Internet in the conventional system is as follows.

**Table 5.11 Required network environment**

Network environment	<ul style="list-style-type: none"> <li>· A broadband router capable of setting port forwarding is required. *1</li> <li>· Firewall environments configured using in-house company networks cannot be used. Use a home LAN environment.</li> </ul>
Internet environment	<ul style="list-style-type: none"> <li>· A high-speed wired broadband environment using xDSL, FTTH, or CATV network is required. (1Mbps min. recommended.)</li> <li>· It is necessary to be able to use the protocols (TCP and UDP) and ports used for remote control of the TS-890S. *2</li> <li>· A global IP address is required. *2, *3</li> <li>· A proxy server cannot be used.</li> </ul>

\*1: Refer to the user manual for the broadband router to be used before performing the settings.

\*2: For details, contact your internet service provider.

\*3: Remote operations are possible even if the global IP address is variable, but the IP address may change with uncertain timing. In such cases, it is necessary to check and change the IP address of the connected host when connected from a remote station, which reduces user-friendliness. Consequently, using an environment in which the host station global IP address is fixed, is recommended. Furthermore, if the global IP address cannot be fixed, using a dynamic DNS service enables operations in the same way as an environment with a fixed global IP address.

### 5.6.2. Broadband router settings

In order to pass control data and audio data for remote control between the Internet and the home LAN, set "port forwarding" to the broadband router.

This setting depends on the call method of the broadband router manufacturer, and may be "Port forwarding", "IP masquerade", "Port conversion", "NAT address conversion", etc. Refer to the user manual for the broadband router used.

- Settings for the broadband router at the host station  
Set the following to the host station's broadband router.

#### Port forwarding for control data

Item(Example)	Setting Details
Open IP address	IP address of the Host PC
Protocol	TCP
Port Number	50000(Default)
Direction	Two-way

#### Port forwarding for audio data

Item(Example)	Setting Details
Open IP address	IP address of the Host PC
Protocol	UDP
Port Number	33550(Default)
Direction	Two-way

- Settings for the broadband router at the remote station  
Set the following to the remote station's broadband router.

#### Port forwarding for control data

Item(Example)	Setting Details
Open IP address	IP address of the PC running ARCP-890
Protocol	TCP
Port Number	50000(Default)
Direction	Two-way

If you use ARVP-10 for VoIP software, you do not need to configure port forwarding for audio data.

#### Caution:

- For the broadband router settings, refer to the broadband router user manual.

- Incorrect broadband router settings may stop the network or enable illegal external access to the network. Take thorough precautions when changing the settings.
- JVC KENWOOD Corporation does not offer support for customer PCs and networks.

## 5.7. PC settings in conventional system

### 5.7.1. Windows Firewall settings

When ARHP-890 and ARVP-10 access the network for the first time, the OS may open a "Windows Security Alert" window.

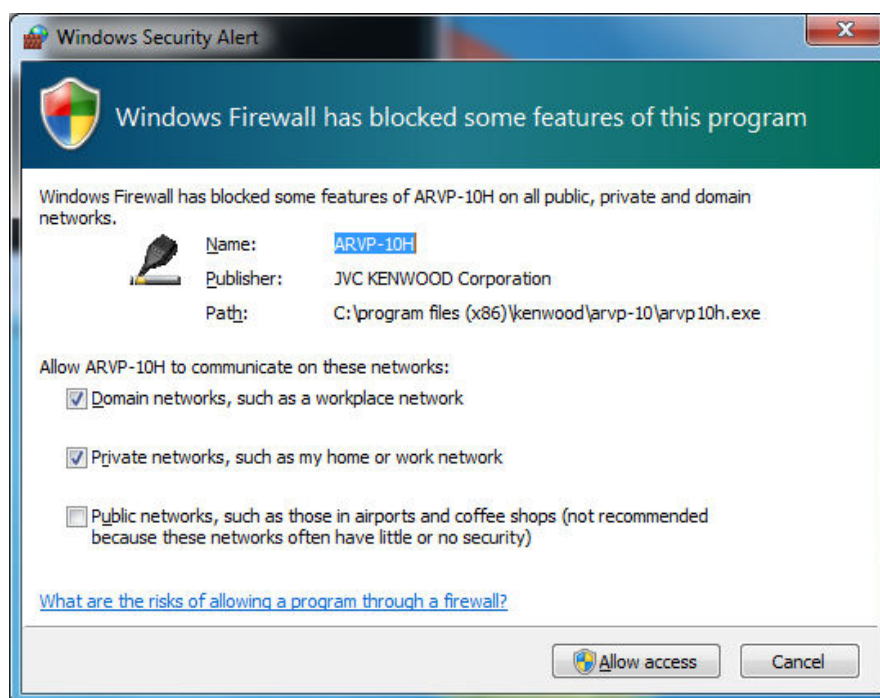

**Fig. 5.18: Windows Security Alert window**

Click "Allow Access" to allow access to control command data communication and voice data communication of ARHP-890 or ARVP-10.

#### Tips:

Normally, if you do the above operation, it will not be warned during the use of ARHP-890 or ARVP-10 after that. If the warning is displayed again while using ARHP-890 or ARVP-10, add the setting to allow ARHP-890 or ARVP-10 communication in the Windows Firewall setting in the control panel.

### **5.7.2. Settings for integrated security software**

When using integrated security software, it is necessary to set it so as not to disturb ARHP-890 and ARVP-10 communication. Please refer to the instruction manual of your integrated security software and set it.

## 6. Limitations

- In remote operation via the network, in principle, delays (during analog/digital conversions) and data loss (which is greatly dependent on traffic) are unavoidable. Therefore it may not be able to perform smooth operation compared with normal radio operation. Specifically, there are the following phenomena.
  - Audio may break up.
  - Standby time may be delayed (in particular, it is not suitable for contests or quick operations such as pile-ups).
  - Audio may differ from the actual transceiver audio
  - Digital mode communications such as image communications with SSTV and AFSK, PSK-31, etc., may be disabled.
  - etc.
  
- Broadband is recommended for the internet line used. As a benchmark, use a minimum of 1 Mbps. The speed of analog modems that use telephone lines will greatly reduce sound quality, and may destabilize control, and so cannot be used.
  
- CW operations are possible, but keying using normal telegraph key is not possible. Strings entered using the keyboard are collated for transmit operations.
  
- If the USB audio function is used for the audio communication between PC and TS-890S, in principle, delays occur in audio transmission. Moreover, it may cause sound break depending on PC performance and operating environment etc.

\* Depending on the combination of PC and sound functions, normal operations may be disabled. JVC KENWOOD does not offer support for customer PCs.

## 7. Cautions

- For using the remote operations that described in this document, it is necessary to set and change the open broadband router port, Windows firewall functions, and comprehensive security software. Furthermore, it is the customer's responsibility to handle security when using this system. If you do not have confidence in the settings, we recommended you stop using the system.
- Please be careful not to leak ID and password used for remote operation to others. Make sure that the ID and password settings cannot be guessed easily by unauthorized people.

## 8. Frequently Asked Questions

This section introduces questions that have been asked to date, and subjects verified by JVC KENWOOD Corporation.

### ■ Installation

Question	Answer
When the KNS connection is via the internet, cannot use KNS unless I obtain a global IP address?	When the KNS connection is via the internet, a global IP address is required.
The global IP address of the host station is variable, but can I use KNS connection via the Internet?	<p>You can use it even if the global IP address is variable, but it is inconvenient to set the IP address again each time the global IP address changes. We recommend using a fixed global IP address.</p> <p>Even in the case of a variable global IP address, using the dynamic DNS service eliminates the effort of resetting the IP address and can be used in the same way as in the case of the fixed global IP address.</p>
I am using the CATV internet. Can I use KNS connection via the Internet?	<p>If you can obtain a fixed global IP address, you can use KNS connection via the Internet.</p> <p>If you are using a type with a built-in broadband router in the cable model, you can use KNS connection via the Internet if you can set port forwarding.</p>
I have an environment with a proxy or firewall on the host station or remote station, or both, can I use KNS connection via the Internet?	<p>In environments with Proxy and firewall, KNS connection via the Internet cannot be used. KNS connection via the Internet can be used only in the general home network environments for both host station and remote station.</p>
Can I use KNS connection via the Internet from wireless LAN or BWA (Broadband Wireless Access)?	For wireless best-effort type, it is not recommended because line speed is not constant.

Question	Answer
Can I use a USB headset or a Bluetooth headset with a remote station PC?	Although you can use a USB headset or a Bluetooth headset, USB headset and Bluetooth headset are assumed to take time to standby because there is unavoidable delay. If delay is a problem, using USB headset or Bluetooth headset is not recommended.
Can you listen to side tone when keying in CW mode?	It is possible to hear the side tone.
The port number used by the TS-890S seems to be TCP: 60000 for command communication, UDP: 60001 for voice communication, but can I change it?	You cannot change the port number used by the TS-890S.



## ■ Connection

Question	Answer
<p>I cannot connect to the host station.</p>	<p>Check the settings of the remote station.</p> <ul style="list-style-type: none"> <li>▪ Check whether the connection type is correctly selected "Settings" in "Tool" menu of the ARCP-890.</li> <li>▪ For connection directly connected to TS-890S, select "KNS (KENWOOD NETWORK COMMAND SYSTEM) (Directly to TS-890S)" in " Connection to the TS-890S" and check whether the PC IP address is correctly selected. Confirm that "Connect to" is selected correctly and the IP address, type of administrator / user, administrator ID, user name and password of the connection destination are correct.</li> <li>▪ For connection via ARHP-890, select "KNS (KENWOOD NETWORK COMMAND SYSTEM) (Via ARHP-890)" in " Connection to the TS-890S" and check whether the IP address of PC is correctly selected. Confirm that "Connect to" is selected correctly and the IP address, type of administrator / user, administrator ID, user name and password of the connection destination are correct.</li> <li>▪ Check the port forwarding setting of the broadband router.</li> </ul> <p>Check the settings of the host station.</p> <ul style="list-style-type: none"> <li>▪ For connection directly connected to TS-890S, check whether the TS-890S IP address, user name and password are correct.</li> <li>▪ For connection via ARHP-890, check whether the ARHP-890 IP address, port number, user name and password are correct.</li> </ul>

## ■ Internet

Question	Answer
<p>I cannot connect to the host station via the Internet.</p>	<p>Make sure you can connect to the website or Internet mail server.</p> <p>If there is no problem, please check the following.</p> <ul style="list-style-type: none"> <li>· Make sure that the port for transceiver control and the port for VoIP software are open to the broadband router of the host station.</li> <li>· Make sure that there are not two or more broadband routers (hereafter called "BBR") on the host station network. If there are two or more BBRs, either open the port required by KNS for either of the BBRs, or stop one of the BBRs and make sure that only one BBR exists on the network, then set the required KNS port to open on the BBR. (Refer to " (Supplement): FAQ: Explaining the Internet "Cannot operate transceiver"" .)</li> </ul>

## ■ Operating System

Question	Answer
<p>When trying to connect with KNS, Windows warning message will be displayed.</p>	<p>Add software used by KNS to Windows Firewall exception.</p>

## ■ Operations

Question	Answer
<p>Can I use ARCP-590G, ARCP-990, ARCP-590, ARCP-480 or ARCP-2000?</p>	<p>Use the ARCP-890 for the TS-890S.</p> <p>The ARCP-590G is exclusively for TS-590SG.</p> <p>The ARCP-990 is exclusively for TS-990S.</p> <p>The ARCP-590 is exclusively for TS-590S.</p> <p>The ARCP-480 is exclusively for TS-480SAT and TS-480HX.</p> <p>The ARCP-2000 is exclusively for TS-2000, TS-2000X and TS-B2000.</p>

Question	Answer
Can I use ARHP-590G, ARHP-990, ARHP-590 or ARHP-10?	<p>Use the ARHP-890 for the TS-890S.</p> <p>The ARHP-590G is exclusively for TS-590SG.</p> <p>The ARHP-990 is exclusively for TS-990S.</p> <p>The ARHP-590 is exclusively for TS-590S.</p> <p>The ARHP-10 is exclusively for TS-480SAT and TS-480HX.</p>
Received sound quality is different from TS-890S itself.	<p>Audio via the network is affected by voice encoding and data bandwidth, so it will have a different sound quality than the original received sound quality. This is the specification of VoIP.</p>
Can I control the antenna rotator or peripheral devices other than the transceiver?	<p>ARCP-890 only supports control of transceiver.</p>
There are a lot of limitations, can you operate with this system?	<p>Although it is not the same as normal operation, in general communication, it can be quite ordinary operation.</p> <p>The point is getting to be familiar with the specific delays via the network, at the beginning such as the timing of standby may be confused.</p> <p>First of all, it is recommended that you become accustomed to manipulating TS-890S from ARCP-890, next to TS-890S, and challenge to operate in a network environment in the next step.</p> <p>When attempting actual operations, unless telling with a partner, the internet remote operation can be hard to understand.</p>
The received sound of the transceiver cannot be heard from the speaker of the PC on the remote station side.	<p>Audio output level of the TS-890S may be too low. Refer to "Audio I/O level settings" in this document and adjust the output level.</p> <p>If multiple sound devices are connected to the PC on the remote station side, is the output destination of VoIP correct? Please check the VoIP output device in "Configure VoIP" of the ARCP-890.</p> <p>Check whether the VoIP input device setting of the ARHP-890 is correct.</p>

Question	Answer
<p>Noise is mixed in the transmitted and received sound.</p> <p>Or, the transmitted / received sound is small, where should I check and adjust?</p>	<p>Refer to chapter "Setting of VoIP Input/Output level" in this document and adjust the audio input / output level.</p> <p>The sound device driver may need to be upgraded. Try checking for new versions and upgrade the driver.</p> <p>This may also depend on the specifications of the sound device used in your PC. Try using another sound card or USB sound device.</p>
<p>Can I stop the beeps and the voice guidance audio emitted by the transceiver?</p>	<p>If you are building KNS with a conventional system, refer to chapter "Setting beep mixed output" in this document and set it to "Received Audio Only".</p> <p>When audio is input from the LAN connector of the TS-890S, set beep volume and voice guidance volume to 0.</p>
<p>Can I put the PC in sleep mode while not using the host station (ARHP-890)?</p> <p>If the host station (ARHP-890) is not used for a certain period of time, the PC screen of the host station disappears and it cannot respond to the connection request from the remote station.</p>	<p>It takes time to return from sleep mode. Since the response to the remote station cannot be returned until the timeout when returning from the sleep mode, the host station should not enter the sleep mode.</p>
<p>If I make a connection request from the remote station when the host station is not in use, a message is displayed and I cannot connect to the host station.</p>	<p>Is the power saving function of Windows running and the power supply is not supplied to the hard drive built in the PC of the host station?</p> <p>If the hard drive is powered off, the hard drive will turn on to respond, but in this case the response to the remote station cannot be returned by timeout.</p> <p>Therefore, do not turn OFF the power of the hard drive in Windows power function setting.</p>

Question	Answer
<p>Even if you click the "Send" button on the ARCP-890, it will not be modulated.</p>	<p>Refer to chapter "Setting TX Operation for use in ARCP-890 and checking modulation line" in this document and check the setting.</p> <p>Audio input level of the TS-890S may be too low. Refer to chapter "Setting of VoIP Input/Output level" in this document and adjust the input level.</p> <p>Check whether the VoIP output device setting of the ARHP-890 is correct.</p>
<p>Transmitted voice and received voice become larger or smaller, and it is not constant.</p>	<p>Is the AGC turned on in the voice setting of VoIP software?</p> <p>For details, refer to the instruction manual of VoIP software and confirm the setting.</p>
<p>The last part of the voice transmitted from the host station transceiver may be missing.</p>	<p>If you perform an operation to return to reception immediately after you finish talking at the remote station, it may switch to reception earlier than all the voice is transmitted due to the delay of voice transmission.</p> <p>In this case, set the "Delay by TX to RX Transition" time slightly longer at KNS connection in the "Select Modulation Line" from the ARCP-890 "TX/RX" menu</p>
<p>The sound of the transmission monitor cannot be heard properly from the speaker of the PC of the remote station.</p>	<p>If you are using a VoIP software with specifications that cannot be received during sending voice, the sound of the transmission monitor will not be heard properly.</p>

■ Comprehensive security software, etc.

Question	Answer
<p>Although I use comprehensive security software, when I attempt to connect with KNS, the software displays a warning like "Software is trying to connect to the Internet", but I can press "Block" etc. ?</p>	<p>Refer to the instruction manual of your comprehensive security software and make settings so that the port used by communication in the ARCP-890, ARHP-890 and VoIP software is not blocked.</p>

■ Others

Question	Answer
<p>Even if I play music or movies on PC after using KNS operation on the PC I am using as a host station, no sound comes from the PC.</p>	<p>The USB sound of the TS-890S may be selected as the default device in Windows sound setting. Make sure the PC's speaker is selected as the default playback device in Windows sound setting.</p> <p>If you are not using the TS-890S, we recommend that you disconnect the USB cable connected to the TS-890S from the PC.</p>
<p>When playing music or movies while using KNS on a PC that is being used as a host station, that sound will be transmitted from the TS-890S.</p>	<p>During KNS operation, all the sounds output from the PC are input to the TS-890S as transmitted voice.</p> <p>Do not play music or movies while KNS is in operation. Also, we recommended that other software be terminated as well.</p>
<p>Suddenly large sounds are output from the transceiver at the host station.</p>	<p>This is because the user of the remote station is operating the volume control.</p> <p>In chapter "Setting of Speaker Mute" of this document, confirm that the speaker mute is ON.</p> <p>In the conventional system, the ARHP-890 can prohibit volume operation from the remote station.</p> <p>Select "Settings" in the "Tools" menu and check "TS-890S Mute speaker".</p>
<p>Is there any setting that allows the host station's PC to automatically enter the standby state after restarting for some reason?</p>	<p>Select "Settings" in the ARHP-890 "Tools" menu and check "Run automatically at Windows startup".</p> <p>When the PC is restarted, it automatically enters the standby state.</p>

**(Supplement): FAQ: Explaining the Internet "Cannot operate transceiver"**

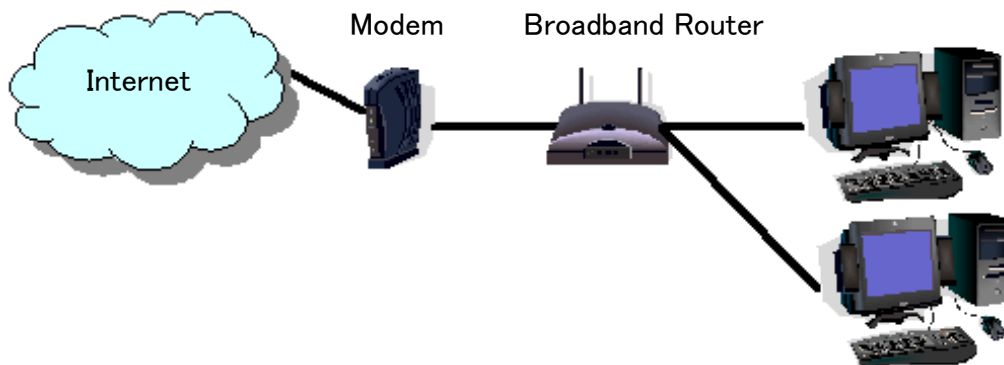
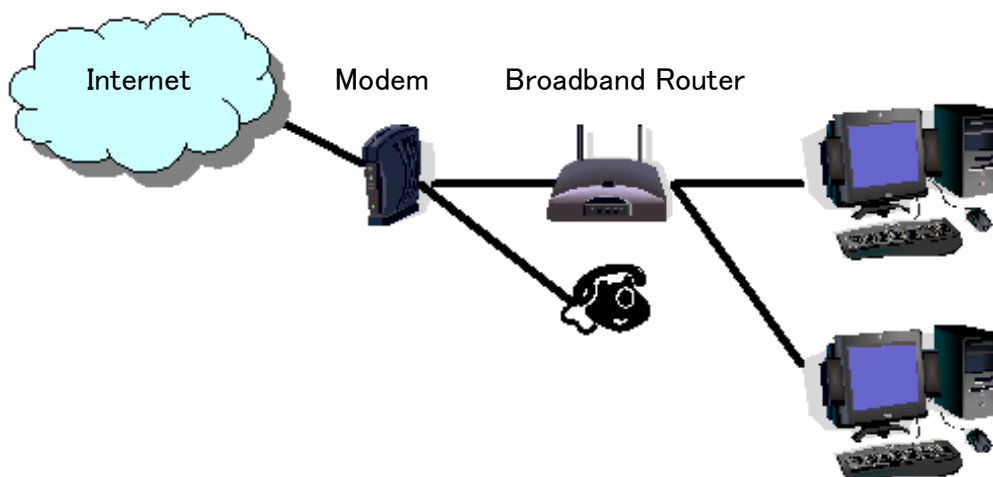

**Fig. 8.1**

As shown in Figure 8.1, even though only one broadband router (BBR) is visible on the network, in reality there are two. (Duplex router phenomenon.)

There are multiple modems with built-in BBR functions, so when connecting such a modem as described above, there must not be two BBR paths connecting the PC to the internet.

Consequently, even if the open port has been set for one BBR only, the required KNS packets will not flow. For this reason, either set the required KNS port to open for both BBRs, or stop one BBR function, and set the network so that there is only one BBR on the network.



**Fig. 8.2**

As shown in Figure 8.2, the case where a telephone is connected directly to a modem, in most models the modem has a built-in BBR function. In such cases, stopping the function of the BBR built into the modem stops the VoIP telephone functions connected to the modem, so VoIP telephony use is disabled.

To prevent the VoIP telephone functions from stopping, stop the functions of the BBR connected to the front of the PC, and set the port required by KNS to open in the BBR built into the modem.

Caution:

Change any settings such as open BBR ports at your own risk.

If you do not have confidence in the settings, we recommend you stop using the system.



---

# KENWOOD