

KENWOOD

144 MHz ALL MODE TRANSCEIVER
430 MHz ALL MODE TRANSCEIVER

TM-255A/E TM-455A/E

INSTRUCTION MANUAL

KENWOOD CORPORATION

Models Covered by this Manual:

- **TM-255A:** 144 MHz All Mode Transceiver (U.S.A./ Canada/ General)
- **TM-255E:** 144 MHz All Mode Transceiver (Europe)
- **TM-455A:** 430 MHz All Mode Transceiver (U.S.A./ Canada)
- **TM-455E:** 430 MHz All Mode Transceiver (Europe)

Notice to the user:

One or more of the following statements may be applicable to this equipment.

FCC WARNING

This equipment generates or uses radio frequency energy. Changes or modifications to this equipment may cause harmful interference unless the modifications are expressly approved in the instruction manual. The user could lose the authority to operate this equipment if an unauthorized change or modification is made.

INFORMATION TO THE DIGITAL DEVICE USER REQUIRED BY THE FCC

This equipment has been tested and found to comply with the limits for a Class B digital device, pursuant to Part 15 of the FCC Rules. These limits are designed to provide reasonable protection against harmful interference in a residential installation.

This equipment generates, uses and can generate radio frequency energy and, if not installed and used in accordance with the instructions, may cause harmful interference to radio communications. However, there is no guarantee that the interference will not occur in a particular installation. If this equipment does cause harmful interference to radio or television reception, which can be determined by turning the equipment off and on, the user is encouraged to try to correct the interference by one or more of the following measures:

- *Reorient or relocate the receiving antenna.*
- *Increase the separation between the equipment and receiver.*
- *Connect the equipment to an outlet on a circuit different from that to which the receiver is connected.*
- *Consult the dealer for technical assistance.*

INTRODUCTION

THANK YOU

We are grateful you decided to purchase this KENWOOD All-Mode transceiver.

The TM-255/TM-455 series of transceivers were developed to satisfy the requirement for a compact, all-inclusive rig that's simple to operate yet has superior performance across the band. VHF/UHF operators can now enjoy the innovative Menu Setup method for feature configuration incorporated in other KENWOOD products.

KENWOOD believes that the compact size coupled with the reasonable cost will guarantee your satisfaction with this product.

PRECAUTIONS

Please read all safety and operating instructions before using this unit. For best results, be aware of all warnings on the unit and follow the provided operating instructions. Retain these safety and operating instructions for future reference.

1 Power Sources

Connect this unit only to the power source described in the operating instructions or as marked on the unit itself.

2 Power Cable Protection

Route all power cables safely. Ensure the power cables can neither be walked upon nor pinched by items placed near or against the cables.

Pay particular attention to locations near AC receptacles, AC extension bars and points of entry to the unit.

3 Abnormal Odors

The presence of an unusual odor or smoke is often a sign of trouble. Immediately turn the power OFF and remove the power cable. Contact a dealer or the nearest Service Center for advice.

4 Electrical Shocks

Take care not to drop objects or spill liquids into the unit through enclosure openings. Metal objects, such as hairpins or needles, inserted into the unit may contact voltages resulting in serious electrical shocks. Never permit children to insert any objects into this unit.

5 Grounding and Polarization

Do not attempt to defeat methods used for grounding and electrical polarization in the unit, particularly involving the input power cable.

6 Ventilation

Locate the unit so as not to interfere with its ventilation. Do not place books or other equipment on the unit that may impede the free movement of air. Allow a minimum of 4 inches (10 cm) between the rear of the unit and the wall or operating desk shelf.

7 Water and Moisture

Do not use the unit near water or sources of moisture. For example, avoid use near bathtubs, sinks, swimming pools, and in damp basements and attics.

8 Outdoor Antenna Grounding

Adequately ground all outdoor antennas used with this unit using approved methods. Grounding helps protect against voltage surges caused by lightning. It also reduces the chance of a build-up of static charges.

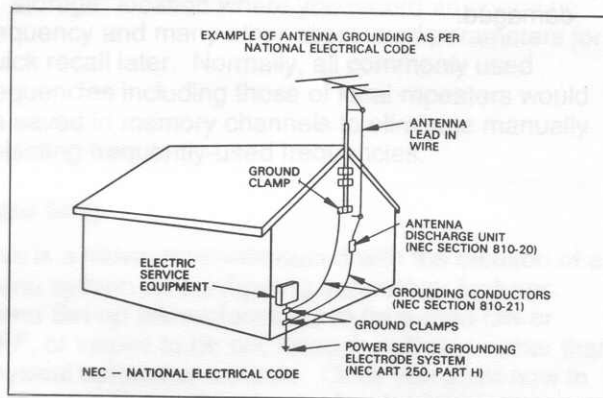

9 Power Lines

Minimum recommended distance for an outdoor antenna from power lines is one and one-half times the vertical height of the associated antenna support structure. This distance allows adequate clearance from the power lines if the support structure should fail for any reason.

10 Heat

Locate the unit away from heat sources such as radiators, stoves, amplifiers or other devices that produce substantial amounts of heat.

11 Cleaning

Do not use volatile solvents such as alcohol, paint thinner, gasoline or benzene to clean the cabinet. Use a clean, cloth with warm water or a mild detergent.

12 Periods of Inactivity

Disconnect the input power cable from the power source when the unit is not used for long periods of time.

13 Servicing

Remove the unit's enclosure only to do accessory installations described by this manual or accessory manuals. Follow provided instructions carefully to avoid electrical shocks. If unfamiliar with this type of work, seek assistance from an experienced individual, or have a professional technician do the task.

INTRODUCTION

14 Damage Requiring Service

Enlist the services of qualified personnel in the following cases:

- The power supply or plug is damaged.
- Objects have fallen, or liquid has spilled into the unit.
- The unit has been exposed to rain.
- The unit is operating abnormally or performance has degraded seriously.
- The unit has been dropped, or the enclosure damaged.

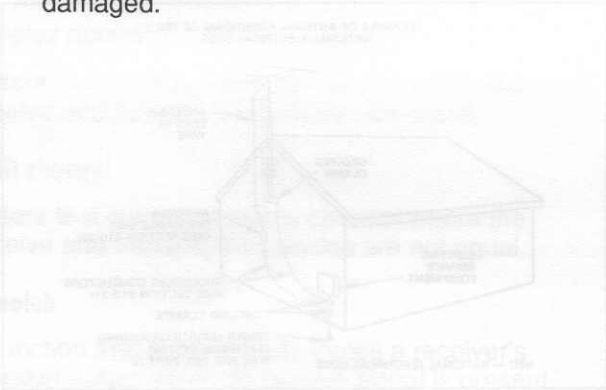

CONVENTIONS FOLLOWED IN THIS MANUAL

The writing conventions described below have been followed to simplify key stroke instructions and avoid unnecessary repetition. This format is less confusing for the reader. Reviewing the following information now will reduce your learning period. That means less time will be spent reading this manual; more time will be available for operating.

Instruction	Meaning	What to do
Press [KEY1]+[KEY2] .	Press the keys simultaneously.	Press and hold KEY1 down, then press KEY2 .
Press [KEY1], [KEY2] .	Press the keys in sequence.	Press KEY1 momentarily, release KEY1 , then press KEY2 .
Press [KEY]+ POWER ON .	Press the key while powering the transceiver.	With the transceiver power OFF, press and hold KEY , then turn ON the transceiver power.
Press [F] (N s) .	Press the Function key for longer than N seconds.	Press and hold the function key until the "F" indicator on the Display begins flashing.
Press [KEY] (N s) .	Press the key for longer than N seconds.	Press and hold KEY until the function begins.

Note: Basic procedures are numbered sequentially to guide you step-by-step. Additional information pertaining to a step, but not essential to complete the procedure, is provided in bulleted form following many steps for further guidance.

FEATURES

- Convenient to transport, install and operate from either a portable, mobile or fixed station installation due to the compact size.
- Setting-up transceiver functions is simple with the easy-to-use Menu System.
- Busy-Frequency Stop automatically stops any of the scan functions on a busy frequency. Time-operated and Carrier-operated modes are provided for further flexibility.
- "Fuzzy logic" controls the frequency step size as you turn the Main Tuning control. The faster you turn the control, the larger the step size up to the maximum step available.
- Automatic Power Off switches OFF the power if the transceiver has not been used for approximately 3 hours.
- Up to 4 functions can be assigned to the Programmable Function (PF) keys on the microphone allowing you to personally customize your transceiver's operation.
- Despite the small overall case size, numerous additional features have been included for the VHF/UHF enthusiast.

ATTENTION

- ◆ *Noise entering from the DC power supply or static electricity may disable the buttons or the Tuning controls. If this occurs, determine the source of the interference and take appropriate measures to reduce or eliminate the offending noise. If the transceiver still does not function normally, reset the microprocessor (page 34).*
- ◆ *Resetting the microprocessor clears the memory channels and returns the menu settings (described later) to their default values.*
- ◆ *This transceiver contains a cooling fan. As the heat sink temperature rises because of continuous transmission, the fan speed accelerates to its maximum speed, and the sound of the fan will become more noticeable. If the heat sink temperature becomes excessively high, the temperature protection circuit will trip and reduce the transmit output power.*

SUPPLIED ACCESSORIES

Accessory	Part Number	Qty.
Microphone		
U.S.A., Canada, General ¹	T91-0397-XX	1
Europe, General ¹	T91-0398-XX	1
Microphone hanger		
U.S.A., Canada	J20-0319-XX	1
Microphone hanger screws		
U.S.A., Canada	N46-3010-XX	1 set
DC power cable	E30-2111-XX	1
Fuse, 15 A	F51-0017-XX	1
• For the transceiver		
Mounting bracket	J29-0422-XX	1
Mounting bracket screws	N99-0383-XX	1 set
Wrench	W01-0414-XX	1
Warranty card	-	1
(U.S.A., Canada, Europe ²)		
Instruction manual	B62-0415-XX	1

¹ Excluding some General market versions.
² Excluding some European versions.

CONTENTS

CHAPTER 1 INSTALLATION AND CONNECTION

PREPARATION FOR MOBILE OPERATION	1
MOBILE INSTALLATION	1
DC POWER CABLE CONNECTION	2
ANTENNA CONNECTION	2
GROUND CONNECTION	2
IGNITION NOISE	3
PREPARATION FOR FIXED STATION OPERATION.....	3
DC POWER SUPPLY CONNECTION	3
ANTENNA CONNECTION	4
GROUND CONNECTION	4
ACCESSORY CONNECTIONS	4
EXTERNAL SPEAKER.....	4
MICROPHONE	4
KEY OR ELECTRONIC KEYS.....	5
PACKET EQUIPMENT	5

CHAPTER 2 GETTING ACQUAINTED

FRONT PANEL	7
REAR PANEL.....	9
MICROPHONE.....	10
DISPLAY	11

CHAPTER 3 MENU SETUP

MENU DESCRIPTION	13
MENU ACCESS	13
MENU CONFIGURATION.....	13
MENU A.....	13
MENU B.....	14

CHAPTER 4 COMMUNICATION

CONFIRMATION BEFORE OPERATION.....	15
REAR PANEL.....	15
FRONT PANEL	15
GETTING STARTED	16
SWITCHING POWER ON/OFF	16
VOLUME ADJUST	16
SQUELCH ADJUST	16
Noise Squelch	16
S-Meter Squelch.....	16
DUAL DIGITAL VFOs.....	17
Selecting VFOs	17
Equalizing VFO Frequencies.....	17
FREQUENCY SELECTION	17
FREQUENCY STEP SIZE.....	17
AUTOMATIC MODE SELECTION	18
SELECTING OUTPUT POWER.....	18

FM OPERATION.....	19
FM REPEATER OPERATION	19
TRANSMIT OFFSETS	19
REVERSE FUNCTION	20
TONE ACCESS	20
AUTOPATCH (U.S.A. AND CANADA VERSIONS)	21
Enabling the Microphone Keypad	21
DUAL TONE MULTI-FREQUENCY (DTMF) CALLS.....	21
PACKET OPERATION.....	22
SSB OPERATION.....	23
CW OPERATION.....	23
CW PITCH CHANGE	23
CW KEYING DELAY	23

CHAPTER 5 MEMORY FEATURES

MICROPROCESSOR MEMORY BACKUP	24
MEMORY CHANNEL DATA	24
MEMORY CHANNEL STORAGE	24
SIMPLEX CHANNEL STORAGE.....	24
SPLIT-FREQUENCY CHANNEL STORAGE ...	25
SCAN FREQUENCY LIMITS STORAGE	25
Programmable VFO Function.....	25
CALL CHANNEL STORAGE	26
MEMORY CHANNEL RECALL.....	26
TEMPORARY FREQUENCY CHANGE	26
MEMORY CONTENTS CONFIRMATION	27
MEMORY TRANSFER.....	27
MEMORY/CALL CHANNEL → VFO	27
TRANSFER OF TEMPORARY DATA	28
ERASING MEMORY CHANNELS	28
FULL RESET	28

CHAPTER 6 SCAN

BUSY-FREQUENCY STOP	29
SCAN RESUME METHODS.....	29
SCAN HOLD	29
MEMORY SCAN	30
GROUP SCAN.....	30
ALL-CHANNEL SCAN	30
MEMORY CHANNEL LOCK-OUT	30
PROGRAM SCAN	31
CONFIRMING LOWER/UPPER FREQUENCY LIMITS	31
BASIC SCAN	31
BAND SCAN	31
MHz SCAN.....	32

VFO/MEMORY/CALL SCAN 32
 SETTING SCAN SPEED..... 32

CHAPTER 7 AUXILIARY FUNCTIONS

RECEIVING..... 33
 RECEIVER INCREMENTAL TUNING (RIT) 33
 IF SHIFT 33
 NOISE BLANKER..... 33
 ADVANCED INTERCEPT POINT (AIP) FUNCTION 33
 TRANSMITTING..... 34
 SPEECH PROCESSOR..... 34
 TIME-OUT TIMER (TOT) 34
 OPERATOR CONVENIENCES..... 34
 MICROPROCESSOR RESET 34
 REMOTE FUNCTIONS USING THE MICROPHONE 35
 PROGRAMMABLE FUNCTION (PF) BUTTON 36
 LOCK FUNCTIONS..... 36
 Frequency Lock..... 36
 Main Unit Lock..... 37
 Microphone Lock 37
 AUTOMATIC POWER OFF (APO)..... 37
 CHANNEL DISPLAY 37
 TRANSVERTER FREQUENCY DISPLAY 37
 PEAK METER HOLD 37
 REPROGRAMMING AUTO MODE/AUTO OFFSET..... 38
 KEY CONFIRMATION BEEP TONE..... 38
 MODULATION MODE AUDIBLE INDICATOR.. 39
 MORSE CODE ALARM OUTPUT..... 39
 DISPLAY DIMMER..... 39

CHAPTER 8 CONTINUOUS TONE CODED SQUELCH SYSTEM (CTCSS)

SELECTING CTCSS FREQUENCIES 40
 USING CTCSS 40

CHAPTER 9 DUAL TONE SQUELCH SYSTEM (DTSS)

STORING DTSS CODES..... 41
 ENABLING DTSS..... 41
 DTSS AND REPEATERS..... 41

CHAPTER 10 PAGE

OVERVIEW 42
 PAGE CODE MEMORY 42
 STORING PAGE CODES 42
 CALLING 43

RECEIVING 43
 RECEIVING A CALL WITH YOUR STATION CODE..... 43
 RECEIVING A CALL WITH A GROUP CODE.. 43

PAGE CODE AND REPEATERS 44
 LOCKING-OUT CODES 44
 AUTO PAGE CANCEL..... 44
 OPEN PAGE..... 44

CHAPTER 11 TONE ALERT

ENABLING TONE ALERT 45

CHAPTER 12 MAINTENANCE

GENERAL INFORMATION..... 46
 SERVICE 46
 SERVICE NOTE 46
 CLEANING..... 46
 INTERNAL ADJUSTMENTS..... 46

CHAPTER 13 TROUBLESHOOTING..... 48

CHAPTER 14 OPTIONAL ACCESSORIES..... 52

CHAPTER 15 INSTALLING OPTIONS..... 53

SPECIFICATIONS..... 55

GLOSSARY..... 57

1 INSTALLATION AND CONNECTION

PREPARATION FOR MOBILE OPERATION

When operating mobile, do not attempt to configure your transceiver or change Menu settings while driving because it is simply too dangerous. Stop the car first, then make the necessary changes. Also, be aware of local laws pertaining to the use of headphones/headsets while driving on public roads. If in doubt, do not wear headphones while mobilizing.

MOBILE INSTALLATION

Install the transceiver in a safe, convenient position inside your vehicle that minimizes danger to your passengers and yourself while the vehicle is in motion. For example, consider installing the transceiver under the dash in front of the passenger seat so that knees or legs will not strike the radio during sudden braking of your vehicle.

■ Installation Example

1 Install the mounting bracket using the supplied flat washers and self-tapping screws.

- The bracket can be mounted with the bracket opening for the transceiver facing down for underdash mounting, or with the opening facing up.

2 Position the transceiver in the bracket to determine the best viewing angle.

- You have 3 positions from which to choose: angled up, horizontal, or angled down.

3 Insert and tighten the supplied SEMS screws and washers using the wrench.

- Double check that all hardware is tightened to prevent vehicle vibration from loosening the bracket or transceiver.

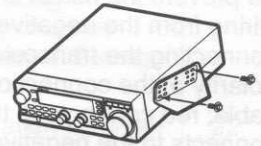
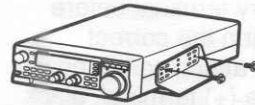
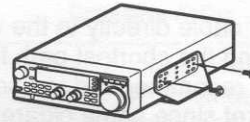
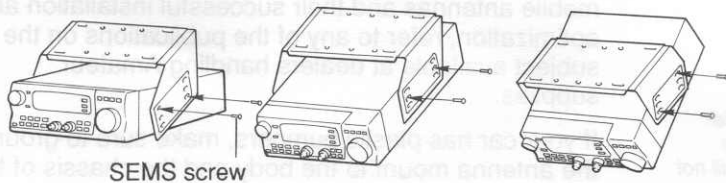
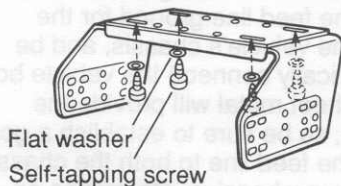

TM-255/TM-455

- Use only the top or middle row of holes to mount the transceiver horizontally.

Note:

- ◆ If more convenient, you can separate the transceiver Front Panel from the transceiver. This allows easier mounting of the panel near the operating position when there is not enough room for the whole transceiver. The transceiver can be installed in the trunk or under the seat.
- ◆ You can also use the optional MB-13 mounting bracket. For the correct mounting procedure, refer to the instructions packaged with the MB-13.

1 INSTALLATION AND CONNECTION

DC POWER CABLE CONNECTION

Route the DC power cable directly to the vehicle's battery terminals using the shortest path from the transceiver. It is not recommended to use the cigarette lighter socket since some cigarette lighter sockets introduce an unacceptable voltage drop.

To prevent the risk of short circuits, disconnect other wiring from the negative (-) battery terminal before connecting the transceiver. Confirm the correct polarity of the connections before attaching the power cable; red connects to the positive (+) terminal, black connects to the negative (-) terminal. Use the full length of the cable without cutting off the excess even if the cable is longer than required. In particular, never remove the fuse holder from the cable. After completing transceiver connections to the battery, then reconnect any wiring removed from the negative terminal.

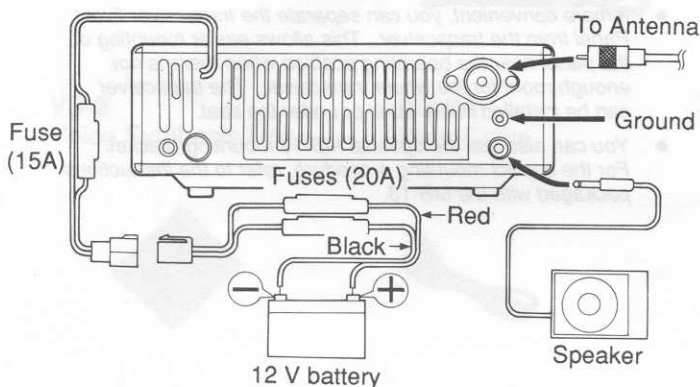

If the power cable must be routed through a hole in the vehicle chassis or body, for example in the firewall at the front of the passenger compartment, use a rubber grommet to protect the cable from abrasion. The entire length of the cable must be dressed so it is isolated from heat and moisture. After the cable is in place, wind heat-resistant tape around the fuse holder to protect it from moisture. Tie down the full run of cable.

The vehicle battery must have a nominal rating of 12 V. Never connect the transceiver to a 24 V battery. Be sure to use a 12 V vehicle battery that has sufficient current capacity. If the current to the transceiver is insufficient, the Display may darken during transmission (at audio peaks during SSB operation), or transmitter output power may drop excessively.

Note:

- ◆ If you use the transceiver for a long period when the vehicle battery has not been fully charged, or when the engine has been stopped, the battery may become discharged, and will not have sufficient reserves to start the vehicle. Avoid using the transceiver under these conditions.
- ◆ Replace blown fuses only after investigating and correcting the cause of the failed fuse. Always replace a blown fuse by a new fuse with the specified ratings.

Replacing Fuses

If the fuse blows, determine the cause then correct the problem. After the problem is resolved, only then replace the fuse. If newly installed fuses continue to blow, disconnect the power plug and contact your dealer or nearest Service Center for assistance.

Function	Fuse Current
Transceiver Power Cable	15 A
DC Power Cable	20 A

CAUTION: Only use fuses of the specified type and rating.

ANTENNA CONNECTION

Before operating mobile, you must first install an efficient, well-tuned antenna. The success of your mobile installation will depend largely on the type of antenna and its correct installation. The transceiver can give excellent results if the antenna system and its installation is given careful attention.

Your choice of 144 MHz or 430 MHz antenna should have a 50 ohm impedance to match the transceiver input impedance. Use low-loss coaxial feed line that also has a characteristic impedance of 50 ohms. Coupling the antenna to the transceiver via feed line having an impedance other than 50 ohms reduces the efficiency of the antenna system, and can cause interference to nearby broadcast television and radio receivers.

CAUTION: Transmitting without an antenna or other matched load connected may damage the transceiver. Always connect the antenna to the transceiver first before transmitting.

GROUND CONNECTION

The ground, which is the other half of the antenna system, is very important when using most mobile antennas. Connect the feed line ground for the antenna securely to the vehicle's chassis, and be certain to bond (electrically connect) the vehicle body to the chassis. The sheet metal will provide the primary ground plane, so be sure to establish a good RF connection from the feed line to both the chassis and the body. For comprehensive information on mobile antennas and their successful installation and optimization, refer to any of the publications on the subject available at dealers handling Amateur supplies.

If your car has plastic bumpers, make sure to ground the antenna mount to the body and the chassis of the car.

IGNITION NOISE

This transceiver has been designed with a Noise Blanker to filter ignition noise. However, some cars may generate excessive ignition noise. If there is excessive noise, use suppressor spark plugs (with resistors), or take other countermeasures as may be required to reduce these undesired electrically generated noises.

PREPARATION FOR FIXED STATION OPERATION

The following diagram illustrates how to connect the cables to the rear of the transceiver. Connect the cables securely so they will not come loose if pulled.

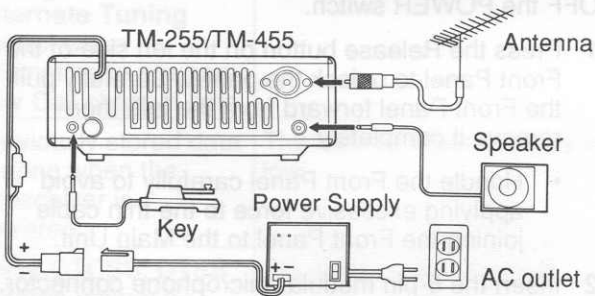

DC POWER SUPPLY CONNECTION

In order to use this transceiver for fixed station operation, you will need a separate 13.8 V DC power supply that must be purchased separately. **DO NOT** directly connect the transceiver to an AC outlet! Use the supplied DC power cable to connect the transceiver to a regulated power supply. Do not substitute a cable with smaller gauge wires.

The following table lists the current consumption for each type of transceiver. Any regulated DC power supply used should have a current rating higher than listed in the table.

Transceiver Model	Current Consumption
TM-255	Less than 13 A
TM-455	Less than 15 A

Plug the connectorized end of the DC power cable into the DC 13.8 V connector on the rear panel of the transceiver, and connect the other end of the cable to the regulated power supply. The red wire must be connected to the positive (+) terminal and the black wire to the negative (-) terminal.

Note:

- ◆ Suitable regulated DC power supplies include the PS-33 and PS-53. All are available as accessories. Choose a power supply with a current rating larger than the current requirements of the transceiver.
- ◆ Before connecting the DC power supply to the transceiver, be sure to switch the transceiver and the DC power supply off.
- ◆ Do not plug the DC power supply into an AC outlet until you make all connections.

Replacing Fuses

If the fuse blows, determine the cause then correct the problem. After the problem is resolved, only then replace the fuse. If newly installed fuses continue to blow, disconnect the power plug and contact your dealer or nearest Service Center for assistance.

Function	Fuse Current
Transceiver Power Cable	15 A
DC Power Cable	20 A

CAUTION: Only use fuses of the specified type and rating.

Installation Example

For a deluxe installation, take the time to install the transceiver in the mounting bracket. The diagram offers some mounting suggestions.

Added benefits of using the mounting bracket in your fixed station include the following:

- You can angle the transceiver for best visibility from your operating position.
- The transceiver remains stationary when you attach connectors or use any of the controls.
- The transceiver is quickly detachable from the bracket if you want to move it to your mobile or any other alternate operating position.
- The bracket eliminates the risk of anybody bumping the transceiver off your operating desk.

If you decide to mount the transceiver in a horizontal plane instead of angling it up or down, use the top or middle row of mounting holes on the bracket. The bottom row of holes cannot be used to mount the transceiver horizontally.

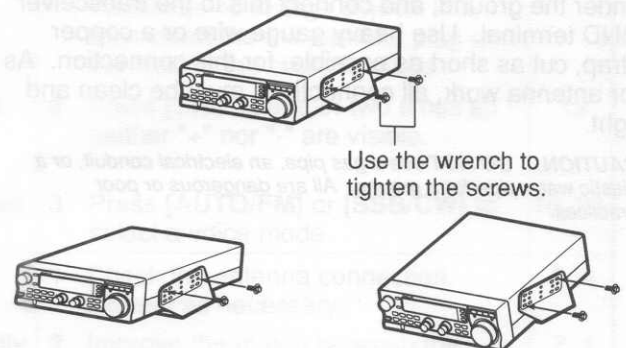

1 INSTALLATION AND CONNECTION

ANTENNA CONNECTION

The type of the antenna system, consisting of the antenna, ground, and feed, will greatly affect the successful performance of the transceiver. Use a properly adjusted 50 ohm antenna of good quality designed for operation at 144 MHz or 430 MHz to let your transceiver perform at its best.

Install low-loss 50 ohm coaxial cable and a first quality connector for the connection to the transceiver. For longer feed line runs, especially for operation at UHF frequencies, you might consider investing in air-dielectric transmission line. The lower loss can make a significant difference for those interested in weak signal operation. In all cases, match the impedance of the feed line and antenna so that the SWR is minimum. Generally, an SWR measurement of 1.5:1 or less is considered satisfactory. All connections must be clean and tight. Coupling the antenna to the transceiver via feed line having an impedance other than 50 ohms reduces the efficiency of the antenna system. It also can cause interference to nearby broadcast television receivers, radio receivers, and other electronic equipment.

CAUTION:

- ◆ All fixed stations should be equipped with a lightning arrester to reduce the risk of fire, electric shock, and transceiver damage.
- ◆ Transmitting without an antenna or other matched load connected may damage the transceiver. Always connect the antenna to the transceiver first before transmitting.

GROUND CONNECTION

At the minimum, a good DC ground is required to reduce the risk of electric shock, and to prevent interference to other electronic equipment. For superior communications results, a good RF ground is required against which the antenna system can operate. Both of these conditions can be satisfied by providing a good earth ground for your station. Bury one or more ground rods, or a large copper plate under the ground, and connect this to the transceiver GND terminal. Use heavy gauge wire or a copper strap, cut as short as possible, for this connection. As for antenna work, all connections must be clean and tight.

CAUTION: DO NOT use a gas pipe, an electrical conduit, or a plastic water pipe for a ground. All are dangerous or poor practices.

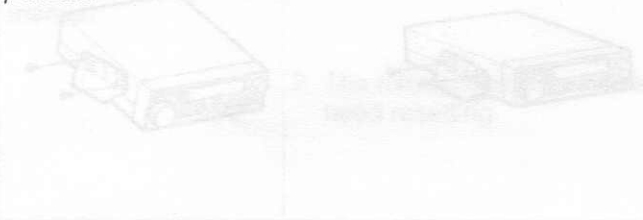

ACCESSORY CONNECTIONS

EXTERNAL SPEAKER

Use an external speaker with 8 ohms impedance. The jack accepts a 3.5 mm diameter mono (2-conductor) plug.

MICROPHONE

To communicate in the voice modes, connect a microphone having an impedance of 600 ohms.

■ Installing the Microphone

Before beginning to install the microphone, switch OFF the POWER switch.

- 1 Press the Release button on the left side of the Front Panel to unlock the panel. Carefully pull the Front Panel forward from the left, then remove it completely.
 - Handle the Front Panel carefully to avoid applying excessive force to the thin cable joining the Front Panel to the Main Unit.
- 2 Insert the 8-pin modular microphone connector, keeping its locking tab upward, into the jack located at the lower left corner of the Main Unit front. Push gently inward until the tab "clicks" into place.
 - If using a microphone that does not have a modular plug, use a conversion cable. For example, the MJ-88 cable accepts an 8-pin microphone plug at one end. The other end has a modular plug that mates with this transceiver.

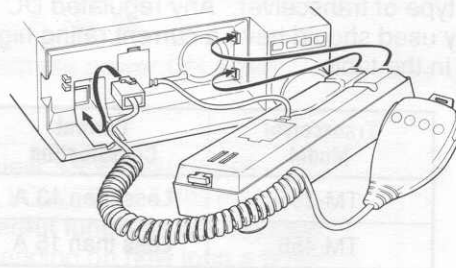

3 Reinstall the Front Panel.

- Check that the bushings holding the thin cable are in place, and the microphone cable is in the groove before closing the Front Panel.
- Press firmly on the Front Panel so the Release button locks.

KEY OR ELECTRONIC KEYS

For CW operation, connect your key or electronic keyer to the KEY jack on the rear panel. Use a 3.5 mm diameter mono (2-conductor) plug. When using an electronic keyer, ensure the keyer wiring polarity is correct.

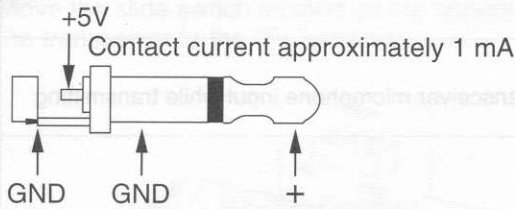

PACKET EQUIPMENT

If you intend to use this transceiver for Packet operation, you will need the following equipment:

- Personal computer with communications software (Alternatively, a "dumb" terminal capable of sending ASCII commands)
- TNC (Terminal Node Controller)
- TNC power supply
- RS-232C cable
- 6-pin mini DIN plug and cable (optional PG-5A)

Refer to the accompanying diagram and the associated hardware instruction manuals to configure the equipment as shown. Connect your TNC to the DATA connector on the transceiver Rear Panel using a cable equipped with a 6-pin mini DIN plug. You can use the microphone connector on the Front Panel; however, the DATA connector is recommended for the following reasons:

- The DATA connector uses connections at different modulation/demodulation points depending on the transmission speed selected via Menu B, No. 77 {page 22}. Therefore, using the DATA connector will give optimum performance especially if using 9600 bps.
- Using a mini DIN plug with a good-quality shielded cable will provide better rejection from computer noise.
- Easier to switch between voice and data modes. No cable changes necessary therefore less chance of damaging the connectors.

Do not share a single power supply between the transceiver and the TNC. Keep as wide a separation between the transceiver and computer as practical to reduce noise-pickup by the transceiver.

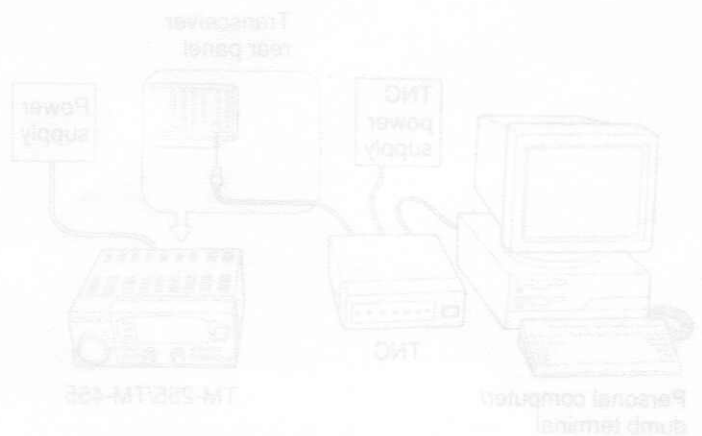

1 INSTALLATION AND CONNECTION

■ DATA Connector Pinout

Pin No.	Pin Name	Function
1	PKD	Packet Data (input) • Transmit data from TNC to transceiver
2	DE	Data Earth • Ground for TNC output
3	PKS ¹	Packet Standby • TNC can use this pin to inhibit the transceiver microphone input while transmitting packet signals.
4	PR9	FM Demodulator Output • For 9600 bps Packet operation • Output Level: 500 mVp-p/ 10 k Ω
5	PR1	Demodulator Output • For 1200 bps Packet and RTTY operation • Audio output is taken before the VOL control (VOL control has no effect on audio level) • Output level: 300 mVp-p/ 10 k Ω
6	SQC	Squelch Control or Relay Output ²
		<p>Squelch Control</p> <ul style="list-style-type: none"> • Inhibits TNC data transmit while transceiver squelch is open. This prevents interference to voice communications on the same frequency and unwanted retries. • Output level Squelch open: +5 V (HIGH) Squelch closed: 0 V (LOW) <p>Relay Output</p> <ul style="list-style-type: none"> • Alternatively, provides a relay output for accessories such as a linear amplifier. • The output switches to GND during transmit. • Current rating: 500 mA maximum

¹ It is not necessary to disconnect the microphone if using the DATA connector. The TNC drives this pin LOW which mutes the microphone.

² Switch selectable: Set internal switch to "PSQ" for Squelch Control or "RL" for Relay Output {page 47}.

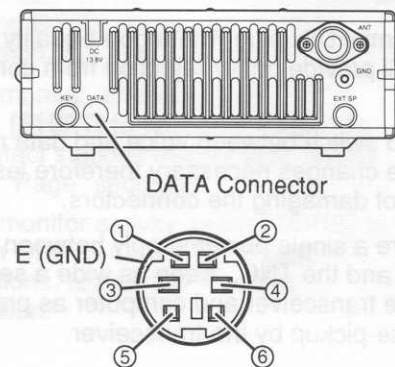
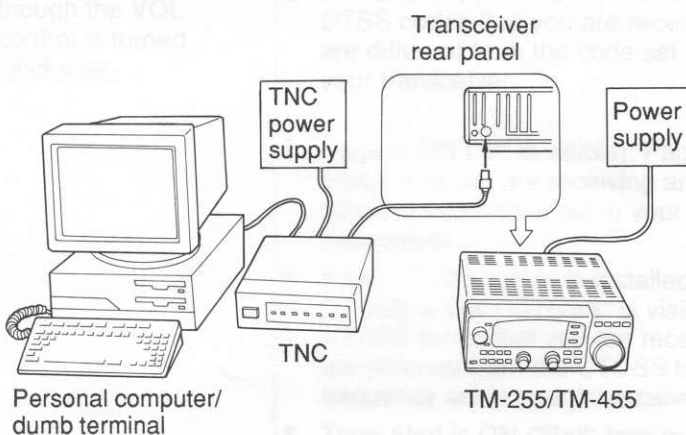

2 GETTING ACQUAINTED

The following sections describe basic functions of the controls, buttons, and indicators on the Front Panel, the jacks and connectors on the Rear Panel, and the indicators on the Display. For full explanations of functions mentioned, refer to the appropriate section elsewhere in the manual.

FRONT PANEL

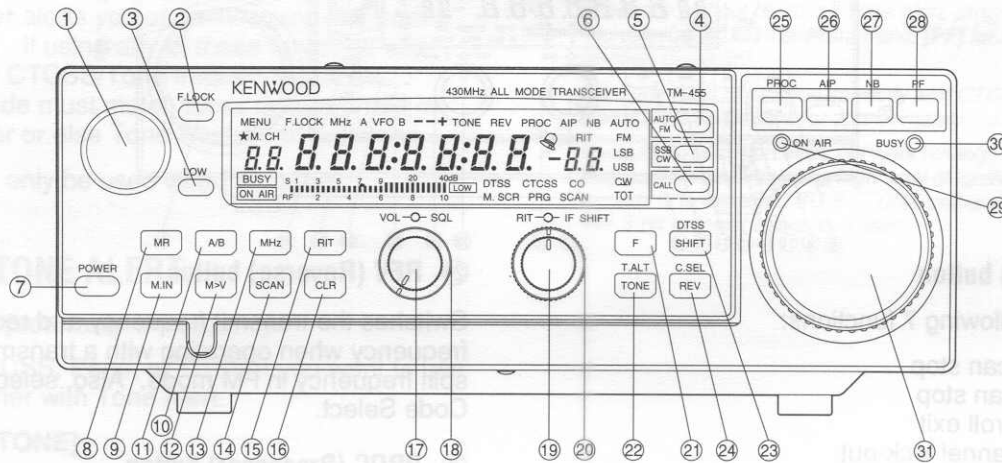

① ALTERNATE TUNING control

Provides the following 3 functions:

- Frequency change
- Memory channel select
- Menu number select

② F.LOCK (Frequency Lock) button

Locks or unlocks many Front Panel and microphone buttons, keys and controls. Refer to "LOCK FUNCTIONS" {page 36} for the complete list. Also used to cycle through menu selections while Menu Setup is being accessed.

③ LOW button

Toggles the transmitter output power between High and Low. Also used to cycle through menu selections while Menu Setup is being accessed.

④ AUTO/FM button

Toggles the modulation mode between AUTO and FM.

⑤ SSB/CW button

Toggles the modulation mode between SSB and CW.

⑥ CALL button

Recalls the Call channel.

⑦ POWER switch

Press to switch the transceiver ON or OFF.

⑧ MR (Memory Recall) button

Selects the Memory Recall function to allow memory channels to be accessed.

⑨ M.IN (Memory Input) button

Provides the following 2 functions:

- Memory Store
- Memory Scroll

⑩ Microphone cable channel

After connecting the microphone, position the cable in the channel before closing the Front Panel. Refer to "Installing the Microphone" {page 4}.

⑪ A/B button

Provides the following 4 functions:

- VFO A or VFO B select
- VFO mode restore
- Partial reset
- Menu A or Menu B select

⑫ M>V (Memory → VFO) button

Copies the contents of the currently displayed memory (frequency, modulation mode, etc.) to the VFO used last, then selects VFO mode.

⑬ MHz button

Provides the following 3 functions:

- VFO mode: Activates 1 MHz Step for the **Alternate Tuning** control.
- Memory Recall: Allows programmed memory channels only (ON) or all memory channels (OFF) to be selected.
- Memory Scroll: Allows only empty memory channels (ON) or all memory channels (OFF) to be selected.

⑭ SCAN button

Starts and stops various types of scan functions.

⑮ RIT button

Toggles Receiver Incremental Tuning between ON and OFF. The RIT control adjusts the receiver frequency without affecting the transmitter frequency.

2 GETTING ACQUAINTED

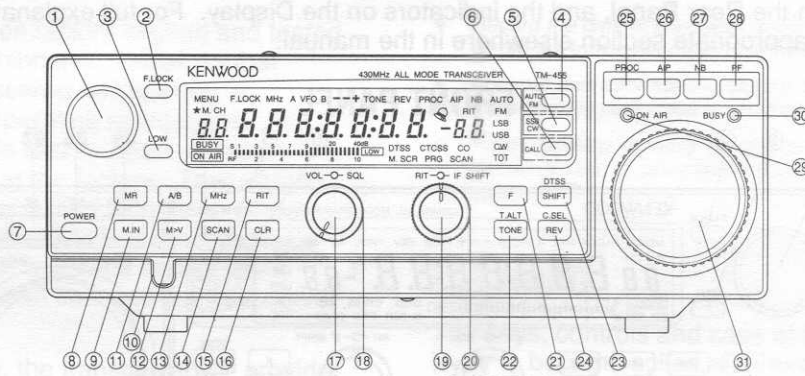

16 CLR (Clear) button

Provides the following 7 functions:

- Program Scan stop
- Memory Scan stop
- Memory Scroll exit
- Memory channel lock-out
- Memory channel erase
- Menu Setup exit
- A=B copy

17 VOL (Volume) control

Adjusts the level of receiver audio from the speaker.

18 SQL (Squelch) control

Adjusts the receiver squelch threshold level. This allows you to mute speaker output while no stations are being received.

19 RIT control

The Receiver Incremental **Tuning** control provides the following 2 functions:

- Receiver frequency shift
With RIT ON, adjusts the receiver frequency without affecting the transmitter frequency.
- Scan speed change

20 IF SHIFT control

Shifts the IF pass band to attenuate or eliminate interfering signals on adjacent frequencies.

21 F (Function) button

Provides the following 3 functions:

- Second Function select
- Menu Setup enter
- Menu Setup exit

22 TONE button

Toggles Tone and CTCSS status between ON and OFF. Also, toggles Tone Alert ON and OFF.

23 SHIFT button

Selects transmit offset direction. Also, toggles DTSS and Page status between ON and OFF while FM mode is selected.

24 REV (Reverse) button

Switches the transmit frequency and receive frequency when operating with a transmit offset or split frequency in FM mode. Also, selects DTSS/Page Code Select.

25 PROC (Processor) button

Toggles the transmitter Speech Processor between ON and OFF.

26 AIP button

Toggles the Advanced Intercept Point (AIP) function between ON and OFF.

27 NB (Noise Blanker) button

Toggles the Noise Blanker ON and OFF.

28 PF button

The function for this button can be assigned from Menu B, No. 74. The function can be changed easily whenever you wish.

29 ON AIR indicator

Lights red when the transceiver is both in Transmit mode and tuned to a frequency within the transmit band.

30 BUSY indicator

Lights green while receiving signals or when **SQL** is turned fully counterclockwise. See "BUSY" indicator in the DISPLAY section on page 11 for more information.

31 MAIN TUNING control

In VFO mode, use to select an operating frequency. The transceiver only transmits on frequencies that lie within the limits of the transmit band.

If memory channel 99 is recalled, use this control to tune across the frequency range from the lower frequency limit to the upper frequency limit stored in this memory.

REAR PANEL

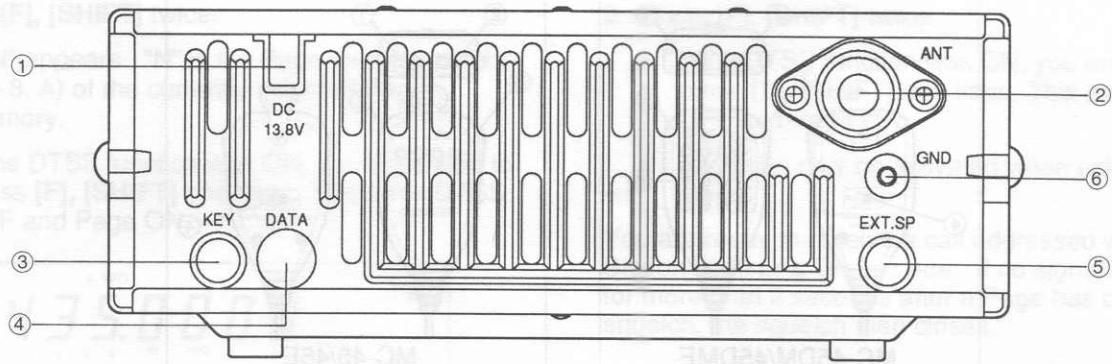

① Power Input DC 13.8 V

Connect a 13.8 V DC power source (pages 2 and 3). You can use either a 12 V vehicle battery or a regulated DC power supply with the supplied DC cable. The TM-255 draws less than 13 A and the TM-455 draws less than 15 A at full transmitter output power.

② ANT

Connect an external antenna designed for operation on the same band as this transceiver (pages 2 and 4). When making test transmissions, connect a dummy load in place of the antenna. The antenna system or load should have an impedance of 50 ohms. Accepts a male PL-259 coaxial plug.

③ KEY

Connect a key or electronic keyer for CW operation. Accepts a 3.5 mm diameter mono (2-conductor) plug. Always turn the transceiver power OFF before inserting the key plug to avoid momentarily transmitting as the plug is inserted. See page 5 for connection details.

④ DATA

Connect a Terminal Node Controller (TNC) for Packet operation. Accepts a 6-pin mini DIN plug. Also can be used to control external equipment such as a linear amplifier. See page 5 for further details.

⑤ EXT. SP

Connect an optional 8 Ω external speaker for clearer audio (page 4). Connecting an external speaker cuts off audio automatically to the internal speaker. Accepts a 3.5 mm diameter (2-conductor) plug.

⑥ GND

Connect a heavy gauge wire or copper strap between the ground terminal and the nearest earth ground (pages 2 and 4). Do not connect the ground wire to either your house electrical wiring, or gas or water pipes. A well-grounded transceiver will reduce the risk of interference to television or broadcast radio receivers. It can also reduce receiver noise caused by static discharges.

MICROPHONE

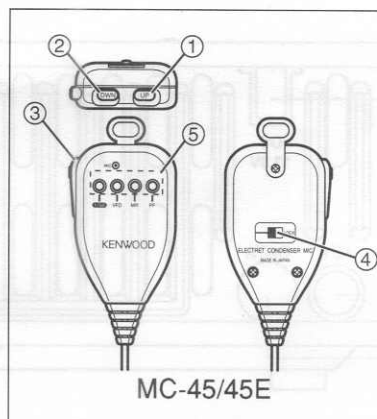
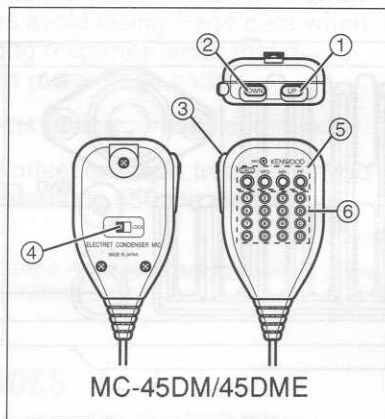

- ① **[UP] button**
- ② **[DOWN] button**

In general, these buttons perform the same function as the **Alternate Tuning** control. They raise or lower the VFO frequency, the memory channel number, the Tone/CTCSS frequency, or the DTSS/Page code digits. Holding either button down causes the action to be repeated. Also, in Menu Setup, the buttons are used to switch among available menu selections for each menu number.

- ③ **[PTT] (Push-to-talk) switch**

Press to transmit; release to receive. Also, press to exit Scan and DTSS/Page code setting.

- ④ **LOCK switch**

Locks all microphone functions except **[PTT]** and, if equipped, the DTMF keypad. This switch does not lock Front Panel buttons.

- ⑤ **PF (Programmable Function) keys**

These keys do not have fixed functions, i.e. their functions can be assigned and changed by the operator {page 35}. By default, the keys have the following functions:

[PF] key

Accesses the last menu number used in Menu Setup.

[VFO] key

Each press toggles between VFO A or VFO B. Same function as **[A/B]** on the Front Panel.

[MR] key

Selects Memory Recall for access to the memory channels. Same function as **[MR]** on the Front Panel.

[CALL] key (MC-45/45DM)

Recalls the Call channel. Same function as **[CALL]** on the Front Panel.

[1750] key (MC-45E/45DME)

Sends a 1750 Hz tone for repeater access.

- ⑥ **DTMF keypad (some versions only)**

The 16-key keypad is used to transmit DTMF tones.

MICROPHONE CONNECTOR

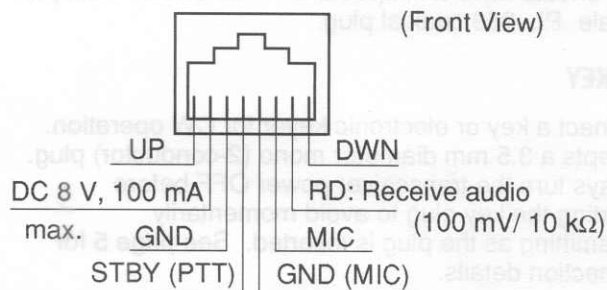

DISPLAY

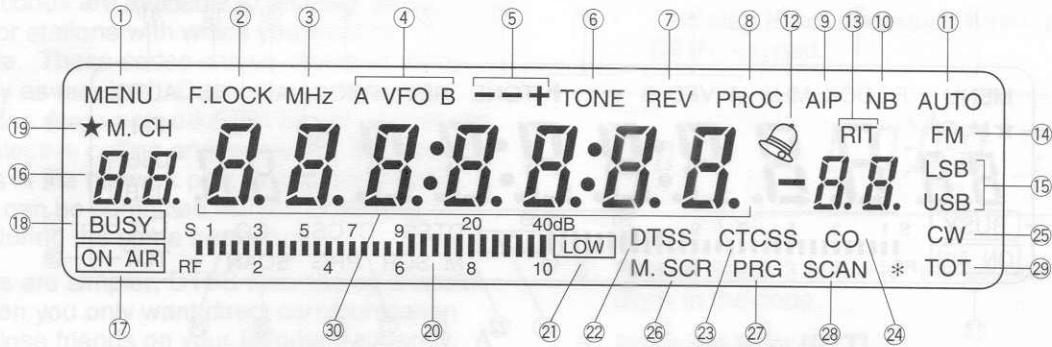

① MENU

Appears when accessing Menu Setup or DTSS/Page Code Select.

② F.LOCK

Appears when the Frequency Lock function is ON.

③ MHz

Appears when the MHz function is ON. Also appears while using Memory Recall when selecting from only programmed channels, or Memory Scroll when choosing empty memory channels.

④ A VFO B

"A VFO" appears when VFO A is selected, and "VFO B" appears when VFO B is selected. VFOs are selected by using [A/B]. "A" and "B" appear while Menu A and Menu B are being accessed respectively.

⑤ ---+

Indicates the transmit offset direction in relation to the receive frequency. "+" and "-" are used by the TM-255A/E and TM-455A. "+", "-", and "---" are used by the TM-455E.

⑥ TONE

Appears when the subaudible tone encoder is ON.

⑦ REV

Appears when the Reverse function is ON. Transmit and receive frequencies are reversed.

⑧ PROC

Appears when the transmit Speech Processor is ON.

⑨ AIP

Appears when the Advanced Intercept Point function is ON.

⑩ NB

Appears when the Noise Blanker is ON.

⑪ AUTO

Appears when Automatic Modulation mode is selected.

⑫ BELL

Appears when Tone Alert is ON.

⑬ RIT display

Appears when Receiver Incremental Tuning is ON. Displays the amount and direction of frequency shift with the RIT ON, and the scan speed value while scanning.

⑭ FM

Appears when the FM mode is selected by pressing [AUTO/FM].

⑮ LSB USB

Appears when Lower Sideband (LSB) or Upper Sideband (USB) is selected by pressing [SSB/CW].

⑯ M.CH

Appears when Memory Recall is selected. Memory Recall is selected by pressing [MR]. The memory channel digits are used while accessing Menu Setup and DTSS/Page Code Select to indicate the Menu No. selected. The dot to the lower right of the memory channel digits indicates the selected memory channel is locked-out of Memory Scan.

⑰ ON AIR

Appears when the transceiver is in the Transmit mode.

⑱ BUSY

Appears when the squelch is open due to a received signal or noise that is greater in strength than the noise squelch threshold level. Also appears when the noise squelch is set to minimum by turning the SQL control fully counterclockwise. If using either CTCSS or DTSS, appears when the squelch is open due to a received signal that contains a CTCSS frequency or DTSS code that matches the Tone frequency or DTSS code programmed in your transceiver.

2 GETTING ACQUAINTED

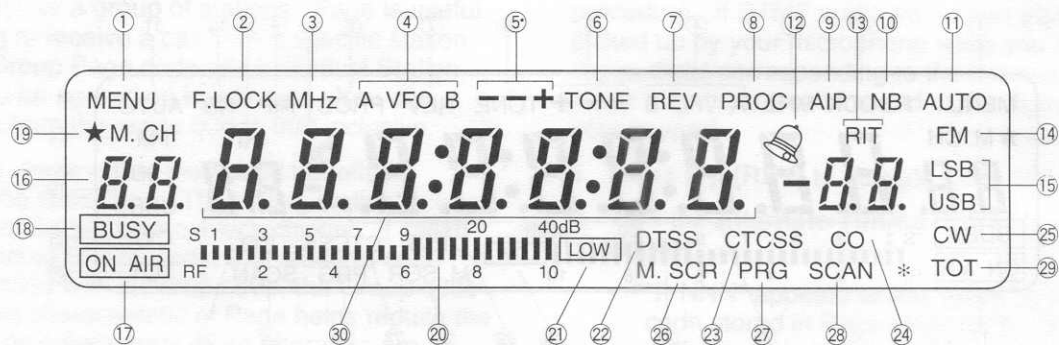

19 STAR

Appears when the selected Page code is locked-out.

20 Meter

In Receive, acts as a Peak Hold S-meter to indicate the signal strength of received signals from S1 to 40 dB over S9. In Transmit, acts as a Peak Hold RF meter to indicate approximate transmit output power on a scale from 1 to 10. The peak hold characteristic can be disabled by menu selection if desired. The S-meter is used for setting the squelch threshold of the S-meter Squelch function.

21 LOW

Appears when Low transmit output power is selected. When "LOW" is not visible, High output power is selected.

22 DTSS

Appears when the Dual Tone Squelch System is ON (FM mode only).

23 CTCSS

Appears when the Continuous Tone Coded Squelch System is ON (FM mode only) when the CTCSS unit is installed.

24 CO

Appears when Carrier-operated Scan Resume is ON. When not visible, Time-operated Scan Resume is in effect.

25 CW

Appears when the CW mode is selected by pressing [SSB/CW].

26 M.SCR

Appears when Memory Scroll is selected by pressing [M.IN].

27 PRG

Appears when memory channel 99 is selected or during Program Scan.

28 SCAN

Appears during Program Scan or Memory Scan.

29 TOT

Appears when the Time-out Timer function is ON.

30 Digital frequency display

Displays the transmit and receive frequencies. Also displays menus while accessing Menu Setup or DTSS/Page Code Select, and minutes/seconds for Tone Alert.

3 MENU SETUP

MENU DESCRIPTION

Many functions on this transceiver are selected or configured via software-controlled menus instead of physical controls on the transceiver. Once familiar with the Menu system, you will appreciate the versatility it offers. No longer is the number and complexity of features restricted by the physical size of transceiver.

The Menus are identified as Menu A and Menu B. Menu A is used to access functions that are frequently changed while Menu B is used for less frequently changed functions.

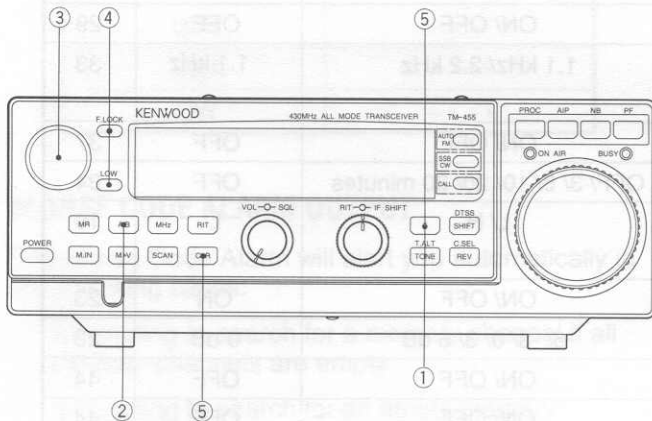

MENU ACCESS

Anytime that you wish to change a function that is controlled by Menu Setup, use the following procedure:

- 1 Press **[F]** (2 s) or microphone **[PF]** to enter Menu Setup.
- 2 Select Menu A or Menu B by pressing **[A/B]** or microphone **[VFO]**.
 - The last menu number used and the current menu selection appear.
- 3 Select the desired menu number by turning the **Alternate Tuning** control.
- 4 Select the desired menu selection by pressing **[F.LOCK]**, or **[LOW]**, or microphone **[UP]** or **[DWN]**.
 - When selecting from a group of numeric menu selections, **[F.LOCK]** or microphone **[UP]** selects in ascending order, and **[LOW]** or microphone **[DWN]** selects in descending order.
- 5 After selecting the desired menu selection, press **[F]**, or **[CLR]**, or microphone **[PF]** to exit Menu Setup.

Note:

- ◆ Accessing menus while the Frequency Lock function is ON cancels Frequency Lock temporarily. Frequency Lock is restored after exiting Menu Setup.
- ◆ The Automatic Power Off timer stops counting while you are in Menu Setup.

MENU CONFIGURATION

Refer to the following tables when configuring Menu A or Menu B.

MENU A

Menu No.	Description	Selections	Default	Page
00	Display Brightness • 4 Illumination levels and OFF (d1: brightest)	OFF/ d4/ d3/ d2/ d1	d2	39
01	CW Keying Delay • Delay time in milliseconds	100/ 200/ 300/ 400/ 600/ 800/ 1000/ 1400/ 1800 ms ¹	600 ms	23
02	CW Receive Pitch • 50 Hz steps	400 to 1000 Hz	800 Hz	23
03	Busy-Frequency Stop (Program Scan) • Enabled (ON) or Inhibited (OFF)	ON/ OFF	ON	29
04	Scan Resume (Program Scan) • Time-operated (0) or Carrier-operated (1)	0/ 1	0	29
05	Memory Scan • All Memory channels (ON) or specific channel group only (OFF)	ON/ OFF	OFF	30
06	SSB/CW Frequency Step Size • Alternate Tuning control or microphone [UP]/[DWN] • 5 step sizes	10 Hz/ 100 Hz/ 1 kHz/ 5 kHz/ 10 kHz	10 kHz	17
07	FM Frequency Step Size • Alternate Tuning control or microphone [UP]/[DWN] • 8 step sizes	10 Hz/ 100 Hz/ 1 kHz/ 5 kHz/ 10 kHz/ 12.5 kHz/ 20 kHz/ 25 kHz	TM-255: 12.5 kHz ² TM-455: 25 kHz	17
08	AF Level Select • Low (L) or High (H)	L/ H	H	16, 38

¹ TM-455: Full Break-in ("Full") can be selected but this function is not supported.

² U.S.A. and Canada: .5 kHz

3 MENU SETUP

MENU B

Menu No.	Description	Selections	Default	Page
50	Key Confirmation Beep Tone	ON/ OFF	ON	38
51	Modulation Mode Audible Indicator • Morse (ON) or Beep (OFF)	ON/ OFF	ON	39
52	Error Alarm • Morse (ON) or Beep (OFF)	ON/ OFF	ON	39
53	Tone/ CTCSS Frequency Select	67.5 to 250.3 Hz	88.5 Hz	21, 40
54	Peak Meter Hold	ON/ OFF	ON	37
55	Main Tuning Control Enabled during Memory Recall	ON/ OFF	OFF	26
56	Program Scan Hold	ON/ OFF	OFF	29
57	RIT Maximum Frequency Shift • 1.1 kHz in 10 Hz steps or 2.2 kHz in 20 Hz steps	1.1 kHz/ 2.2 kHz	1.1 kHz	33
58	Automatic Power Off	ON/ OFF	OFF	37
59	Time-Out Timer	OFF/ 3/ 5/ 10/ 20/ 30 minutes	OFF	34
60	FM Microphone Gain • High (H) or Low (L)	L/ H	L	19
61	SSB Automatic Microphone Gain Control	ON/ OFF	ON	23
62	SSB Fine Microphone Gain control	-6/ -3/ 0/ 3/ 6 dB	0 dB	23
63	Automatic Page Cancel	ON/ OFF	OFF	44
64	Open Page	ON/ OFF	OFF	44
65	DTSS/ Page Transmit Delay Time (offset/ split only)	350 ms/ 550 ms	350 ms	41, 44
66	Squelch Select • Noise Squelch (OFF) or S-meter Squelch (ON)	ON/ OFF	OFF	16
67	S-meter Squelch Hang Time Select	OFF/ 125/ 250/ 500 ms	500 ms	16
68	Main Tuning Control Lock	OFF/ F3/ All	OFF	37
69	[PROC], [AIP], [NB], [PF] Lock	ON/ OFF	OFF	37
70	Microphone PF1 Key Assignment	00 to 99	Menu Setup (83)	35
71	Microphone PF2 Key Assignment	00 to 99	Memory Recall (33)	35
72	Microphone PF3 Key Assignment	00 to 99	VFO mode (20)	35
73	Microphone PF4 Key Assignment ¹	00 to 99	Call channel Recall (24)	35
74	PF Button Assignment	00 to 99	Voice synthesizer (85)	36
75	Channel Display • Frequency Display (ON) or Channel Display (OFF)	ON/ OFF	ON	37
76	Transverter Frequency Display • 1240 to 1299 MHz or 2400 to 2449 MHz in 1 MHz steps	OFF/ 1240-1299/ 2400-2449	OFF	37
77	9600 bps Packet Select	ON/ OFF	OFF	22
78	Automatic Offset Select	ON/ OFF	ON ²	20

¹ MC-45 and MC-45DM only

² TM-255A (General version) and TM-455A/E: OFF

4 COMMUNICATION

CONFIRMATION BEFORE OPERATION

Before proceeding, run through the following checklist to double check that your transceiver is ready to operate:

REAR PANEL

■ ANT Connector

- Is the correct antenna actually connected?
- Is a lightning protector installed for a fixed station?
- Are interconnecting coaxial cables between the transceiver, accessory station equipment, and the antenna connected?
- Are all cable connectors well-installed (including no cold solder joints?) and screwed tight?
- Are coax switches set for the correct antenna?

CAUTION: DO NOT transmit without connecting an antenna or dummy load to the ANT connector. The transceiver can fail.

■ DC 13.8 V (DC Power Cable)

- Is the power cable connected and locked in place? (Do not turn on the transceiver or DC power supply yet.)

■ GND (Ground)

- Is the transceiver actually grounded to your vehicle chassis and body, if in a mobile, or to an earth ground using recommended grounding practices, if in a fixed station?

■ KEY Jack

- Is a key or keyer connected correctly for CW operation?

■ DATA Connector

- Is a TNC connected correctly for Packet operation?

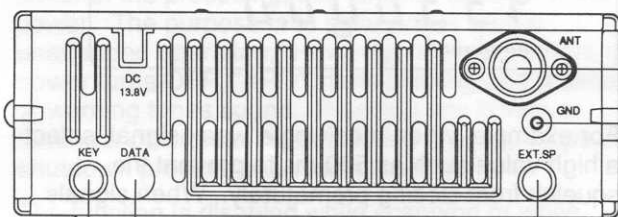

Connect a TNC to operate Packet.

Connect a key or keyer to operate CW.

Connect an external speaker if you wish.

Connect a 50 Ω antenna.

Connect to the nearest earth ground.

FRONT PANEL

■ Controls

- Are they preset as shown in the diagram?

■ Microphone

- Is a recommended microphone installed correctly per instructions on page 4?

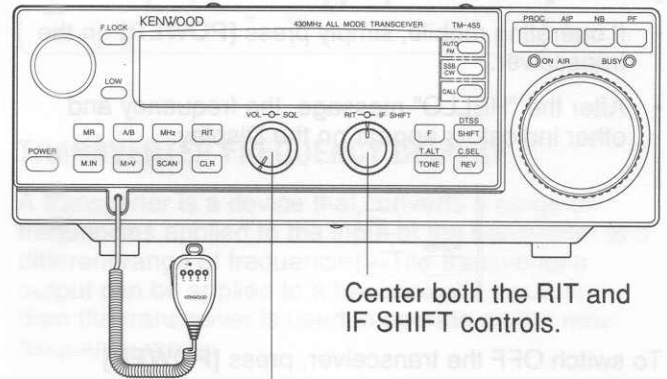

Center both the RIT and IF SHIFT controls.

Turn the VOL and SQL controls fully counterclockwise.

4 COMMUNICATION

GETTING STARTED

This section provides general information you need to know regardless which mode you plan to use when operating.

SWITCHING POWER ON/OFF

Switch ON the DC power supply, then press **[POWER]** to switch ON the transceiver.

- If operating mobile, simply press **[POWER]** on the transceiver.
- After the "HELLO" message, the frequency and other indicators appear on the Display.

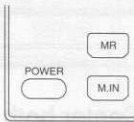

To switch OFF the transceiver, press **[POWER]** again.

- In a fixed installation, after the transceiver has been switched ON, it can then be switched OFF or ON by using only the power switch on the DC power supply.

VOLUME ADJUST

Turn the **VOL** control clockwise to increase the audio level, and counterclockwise to decrease the level.

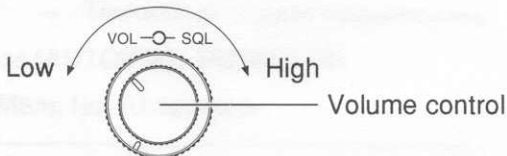

Menu A, No. 08 {page 13} also allows you to change the received audio level. Toggle between a High or a Low level setting. The default is High (H).

SQUELCH ADJUST

The purpose of squelch is to silence audio output from the speaker when no signals are present. When squelch is set correctly, you will hear sound only when a station is actually transmitting. The point at which ambient noise on a frequency just disappears, called the squelch threshold, depends on the modulation mode and frequency. Setting the squelch threshold too high causes squelch to remain closed while a weak signal is present. The station will not be heard. You may mistakenly think that receiver sensitivity is low or you have an audio problem.

Setting the threshold too low allows noise to be heard between transmissions from other stations. However, while receiving weak signals, turn the control fully counterclockwise for most reliable operation. Many operators prefer leaving the squelch control fully counterclockwise unless operating full-carrier modes such as FM.

Noise Squelch

Turn the **SQL** control to just eliminate the background noise when no signal is present, or set and forget at full counterclockwise rotation.

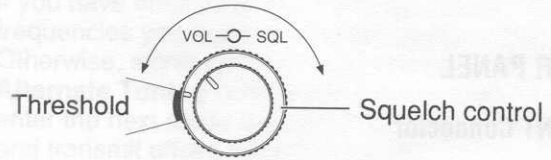

S-Meter Squelch

By using S-meter Squelch, you can set the squelch threshold so the squelch does not open until a signal with the same or greater strength than the S-meter setting is received. Use Menu B, No. 66 {page 14} to select either Noise Squelch or S-meter Squelch. The default is Noise Squelch (OFF).

After switching S-meter Squelch ON, adjust the **SQL** control to set the S-meter for the minimum signal strength that you want to open the squelch. If the **SQL** control is turned fully counterclockwise while S-meter Squelch is ON, the transceiver will function as though Noise Squelch is being used since virtually any signal will open the squelch. As the **SQL** control is turned further clockwise, the S-meter starts to rise indicating the larger signal that is required to open the squelch. If the **SQL** control is turned fully clockwise, a receive signal that is $S9 + 40$ dB must be received before the squelch will open. If the "BUSY" indicator remains off after adjusting the **SQL** control, this means that the level of noise or signal on the current frequency is lower than the S-meter setting.

If you want to change the amount of time the squelch remains open after the received carrier from the other station drops, choose a new value for Hang Time Select via Menu B, No. 67 {page 14}. The default is 500 ms.



For example, when receiving a weak signal, select a high value such as 500 ms to prevent the squelch from closing prematurely. When signals are strong, use a lower value such as 125 ms or OFF for quick turnarounds in your conversation.

DUAL DIGITAL VFOs

The A and B VFOs function independently so that different or the same frequencies can be selected by each VFO. Use the following buttons to select or to copy the frequency data from one VFO to the other.

Selecting VFOs

Press **[A/B]** to toggle between VFO A and VFO B.

- 1 Assume that you are presently using VFO A.



- 2 Press **[A/B]**.
- 3 VFO B is selected and the frequency currently selected by VFO B is displayed.



- 4 Press **[A/B]** again to toggle back to VFO A.

Equalizing VFO Frequencies

Press this button to transfer the frequency and modulation mode of the active VFO to the inactive VFO.

- 1 Assume that you are presently using VFO A.



- 2 Press **[A/B]**.
- 3 VFO B is selected and the frequency currently selected by VFO B is displayed.



- 4 Press **[CLR]**.
- 5 Press **[A/B]** again.
 - This selects VFO A again. Note that the VFO B frequency and the modulation mode have been copied to VFO A due to Step 4.

FREQUENCY SELECTION

Turn the **Main Tuning** control clockwise to raise the operating frequency and counterclockwise to lower the frequency.

Alternate Tuning Control

Use the **Alternate Tuning** control to change the frequency using larger steps than the **Main Tuning** control. Turn this control clockwise to raise the frequency and counterclockwise to lower the frequency. The step size of the **Alternate Tuning** control is changed via Menu Setup as explained below.

Microphone Keys

You can also use **[UP]** or **[DWN]** on the microphone to change the frequency. Each press of **[UP]** or **[DWN]** raises or lowers the frequency 1 step from the current frequency.

FREQUENCY STEP SIZE

Main Tuning Control

The frequency step size automatically varies depending on how fast the **Main Tuning** control is turned due to "fuzzy logic". As the control is turned more quickly, the frequency step increases through the range of 5 Hz to 200 Hz. In the FM mode, the range is from 50 Hz to 2 kHz.

Alternate Tuning Control

The frequency step size is selected via Menu A, No. 06 for SSB and CW modes {page 13}. Use Menu A, No. 07 for FM mode. There are 5 steps available for SSB/CW and 8 steps for FM. These menu selections also affect the step size when using microphone **[UP]/[DWN]**.

Version	FM Mode (kHz)		SSB/CW Mode (kHz)
	TM-255	TM-455	TM-255/455
Canada U.S.A.	5	25	10
Europe General	12.5	25	10

MHz Button

- 1 Press **[MHz]** if you want to change the frequency in 1 MHz steps.
 - "MHz" appears.
 - Turning the **Alternate Tuning** control or pressing microphone **[UP]/[DWN]** causes the frequency to change in 1 MHz steps.
- 2 Press **[MHz]** again to switch OFF the MHz function when you want to revert back to the previous step size.

4 COMMUNICATION

AUTOMATIC MODE SELECTION

Every Amateur band is subject to frequency allocations plans commonly referred to as Band Plans. Following these Band Plans helps reduce interference between stations that want to use different modulation modes on the same band. Automatic Mode is a function that automatically selects the correct mode according to these plans. For example, if you are currently operating FM and then move to a frequency that is in the SSB section of the band, your transceiver mode automatically changes to the SSB mode.

Automatic Mode is enabled by selecting AUTO with [AUTO/FM]. You can always override the automatic selection if you want by pressing either [AUTO/FM] or [SSB/CW]. Automatic Mode does not work when changing frequency while using the Receiver Incremental Tuning (RIT) function.

There is a separate function available that allows you to re-program the boundaries for Automatic Mode. Refer to "REPROGRAMMING AUTO MODE" [page 38] for further information on this function.

■ TM-255A Default Automatic Mode Plan

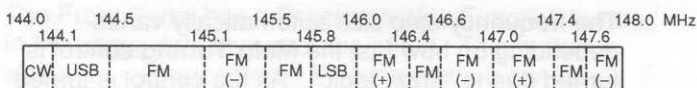

■ TM-255E Default Automatic Mode Plan

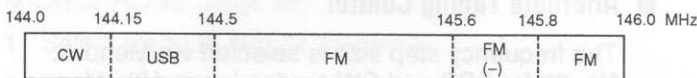

■ TM-455A (U.S.A. and Canada) Default Automatic Mode Plan

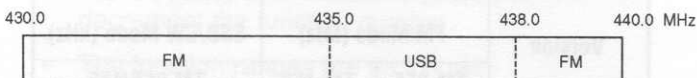

■ TM-455E Default Automatic Mode Plan

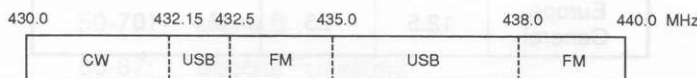

SELECTING OUTPUT POWER

It's wise, and required by law, to select the lowest transmit power that allows reliable communication. If operating from battery power, lower transmit power will give you more operating time before a charge is necessary. Reducing power lowers the risk of interfering with others on the band too. It is possible to change output power while transmitting.

Press [LOW] to select the transmit power you require.

- Default: High power (no indicator visible)
- Each press of [LOW] toggles the output power between High and Low ("LOW")

High ↔ Low ("LOW")

Model	High	Low
TM-255	40 W	5 W
TM-455	35 W	5 W

FM OPERATION

To receive, use the following procedure:

- 1 Select the desired frequency.
- 2 Select the FM mode by pressing **[AUTO/FM]**.
 - "FM" appears.

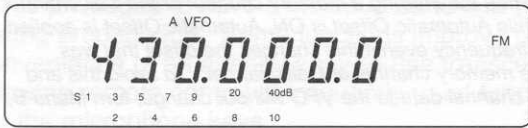

- 3 Set the **VOL** control to a comfortable listening level.
- 4 Select the type of squelch you want to use and adjust as explained earlier {page 16}.

To transmit, proceed to the subsequent steps.

- 5 Listen. Make sure that your transmission won't interfere with others.
- 6 Press and hold **[PTT]**.
- 7 Speak into the microphone.
 - As you transmit, verify that the RF meter is reading upscale confirming transmit output power.
 - FM microphone gain adjustment is via Menu B, No. 60. The default is Low (L). Normally, Low is an appropriate selection for most microphones. Select High if you receive reports of weak audio.



- Speak in a normal tone of voice. The RF meter will indicate a steady carrier, regardless of voice peaks. Speaking too close to the microphone, or too loudly may increase distortion and reduce intelligibility. If operating through a repeater, over deviation will cause your signal to "talk-off" (break up) through the repeater.
- 8 Release **[PTT]** to receive again.

FM REPEATER OPERATION

Compared to simplex communication, you can usually transmit over much greater distances by using a repeater. Repeaters are typically located on a mountain top or other elevated location. Often they operate at higher ERP (Effective Radiated Power) than a typical base station. This combination of elevation and high ERP allows communications over considerable distances.

Repeaters are often installed and maintained by radio clubs, sometimes with the cooperation of local businesses from communications industries. During natural emergencies, repeater networks can be a valuable aid to officials responsible for coordinating communications in a community. This assistance may help save lives.

TRANSMIT OFFSETS

All Amateur Radio voice repeaters use a separate receive and transmit frequency. The transmit frequency may be higher or lower than the receive frequency but the difference in frequencies will be a standard amount, or "standard split". Most repeater configurations fall into one of the following categories:

Offset Direction	TM-255A/E	TM-455A	TM-455E
+	+600 kHz	+5 MHz	+1.6 MHz
-	-600 kHz	-5 MHz	-1.6 MHz
--	N/A	N/A	-7.6 MHz

N/A : Not applicable

Whether using VFO mode, Memory Recall, or the Call channel, the transmit offset direction can be changed.

■ Selecting Offset Direction

This function sets the transmit frequency either higher (+) or lower (-) than the receive frequency by a fixed amount.

Press **[SHIFT]**.

- The default is "simplex" (no offset).
- The offset can only be activated when using FM mode.
- Each press of **[SHIFT]** changes the offset as follows:

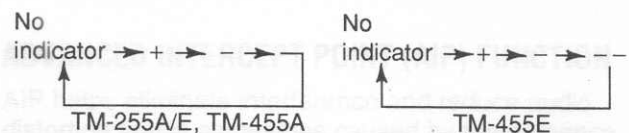

4 COMMUNICATION

Example: A positive (+) transmit offset has been selected.



If the offset transmit frequency falls outside the transmit band, transmit is inhibited until the transmit frequency is brought within the band by at least one of the following methods:

- Move the receive frequency further inside the band.
- Reverse the offset direction.

■ Automatic Transmit Offset (U.S.A. and Canada versions)

Automatic Offset for the TM-255A sold in these markets is programmed according to the standard ARRL (American Radio Relay League) Band Plan for repeater offset direction. You can override this programming by following the "Selecting Offset Direction" procedure in the preceding section. Contact your national Amateur Radio association to obtain up-to-date band plans that explain band usage by mode and activity.

144.0 145.5 146.4 147.0 147.6
145.1 146.0 146.6 147.4 148.0 MHz

S	-	S	+	S	-	+	S	-
---	---	---	---	---	---	---	---	---

S: Simplex

■ Automatic Transmit Offset (European versions)

The TM-255E Automatic Offset is programmed as follows:

144.0 145.6 145.8 146.0 MHz

S	-	S
---	---	---

S: Simplex

Note: In all versions, while Automatic Offset is ON, a manually assigned offset is only effective until the frequency is changed. After Automatic Offset is turned OFF, a manually assigned offset remains effective even after the frequency is changed.

■ Canceling Automatic Offset

Automatic Offset can be canceled via Menu B, No. 78 [page 14]. The default is ON for all versions except TM-255A (General) and TM-455A/E.

Note: After turning ON Automatic Offset again from the OFF status, the feature resumes functioning when a new frequency is selected. When transferring a memory channel or the Call channel to a VFO while Automatic Offset is ON, Automatic Offset is applied to the VFO frequency even if this changes the offset that was stored in the memory channel or Call channel. To avoid this and transfer the channel data to the VFO without change, turn Menu B, No. 78 OFF.

REVERSE FUNCTION

While FM mode is selected, each press of [REV] switches the receive frequency and the transmit frequency. When used while monitoring a repeater, it's possible to check the signal strength of a station accessing the repeater. If the station's signal is strong, it's best to move to a simplex frequency to continue the contact and free-up the repeater.



- If reversal would place the receive frequency outside the receive frequency range, an alarm sounds when [REV] is pressed. No reversal occurs.
- Reverse cannot be activated while [PTT] is held down.
- When Reverse is ON, the frequency cannot be changed.

TONE ACCESS

Each press of [TONE] toggles the Tone function ON and OFF. Tone can only be activated when using FM mode. When the Tone function is activated, a subaudible tone is transmitted each time [PTT] is pressed to transmit.



Often a Tone frequency is required to access repeaters. For example, 88.5 Hz may be needed in the U.S.A. or Canada, and 1750 Hz is used in Europe. The Tone frequencies listed below can be selected. On the TM-255E/TM-455E, press microphone [1750] to send a 1750 Hz tone.

No.	Freq. (Hz)	No.	Freq. (Hz)	No.	Freq. (Hz)	No.	Freq. (Hz)
01	67.0	11	97.4	21	136.5	31	192.8
02	71.9	12	100.0	22	141.3	32	203.5
03	74.4	13	103.5	23	146.2	33	210.7
04	77.0	14	107.2	24	151.4	34	218.1
05	79.7	15	110.9	25	156.7	35	225.7
06	82.5	16	114.8	26	162.2	36	233.6
07	85.4	17	118.8	27	167.9	37	241.8
08	88.5	18	123.0	28	173.8	38	250.3
09	91.5	19	127.3	29	179.9		
10	94.8	20	131.8	30	186.2		

Any of the available tones can be selected via Menu B, No. 53 {page 14}.

AUTOPATCH (U.S.A. and Canada versions)

Some repeaters offer a service called Autopatch. This feature allows you to dial a telephone number from your transceiver and carry on a telephone conversation. This repeater function cannot be used for commercial transactions, but it can save lives when used appropriately during emergencies.

Autopatch requires the use of a DTMF (Dual Tone Multi-Frequency) keypad on your microphone. The keypad includes the 12 keys found on a push-button telephone plus an additional 4 keys (A, B, C, D). These additional keys are required for various control operations by some repeater systems.

■ Enabling the Microphone Keypad

Press [PTT]+[DTMF KEYS].

The transceiver remains keyed for approximately 2 seconds after pressing each key. This allows you to release [PTT] once you begin entering the DTMF keys.

DTMF Tones

Freq. (Hz)	1209	1336	1477	1633
697	1	2	3	A
770	4	5	6	B
852	7	8	9	C
941	*	0	#	D

Note: Some repeaters require a special key sequence to activate Autopatch. Check with the control operator.

DUAL TONE MULTI-FREQUENCY (DTMF) CALLS

Hold down the microphone [PTT] and press [0] to [9], [A], [B], [C], [D], [*], or [#].

- The microphone is muted and the corresponding DTMF tones are transmitted.
- If two keys are pressed, only the tone combination for the key pressed first is sent.

4 COMMUNICATION

PACKET OPERATION

One of the most exciting benefits of owning a VHF or UHF transceiver nowadays is being able to use it for data modes. Due to the ease of setting up a digital station, even those inexperienced with this type of operation can be on-the-air enjoying these new modes quickly.

You can use almost any computer to control one of the widely available Terminal Node Controllers (TNC) since the computer primarily serves to input commands and output received text data to its display. Little real computing power is needed, therefore a high-powered processor is not necessary, and even a "dumb" terminal is satisfactory, at least to start. As you become more experienced, you will realize how well your interest in radio meshes with the world of data communications.

Connecting to one of the many stations with gateways to HF or satellite links can give you national and worldwide messaging or conferencing capability with other Amateurs with nothing more than your single band VHF/UHF transceiver for the communications link. Much reference material is available for getting started in digital communications from any store that handles Amateur Radio equipment. Or, if more convenient, check the radio magazines for mail order bookstores.

The most common mode used on VHF/UHF frequencies for Packet operation is FM. However, there is also some SSB PSK activity on the satellites.

Type of Keying	Modulation Mode / Menu B, No. 77	Transmission Rate	Emission Type
GMSK, G3RUH, etc.	FM / ON	9600 bps	F1D
FSK	FM / ON or OFF	1200 bps	F2D
PSK	SSB / OFF	1200 bps	G2D

Menu B, No. 77	Input Impedance	Standard Modulator Input
OFF	10 k Ω	40 mVp-p
ON	10 k Ω	2 Vp-p

Consider the following before setting Menu B, No. 77:

- OFF: Transmit data input (PKD) sensitivity is 40 mVp-p. This is suitable for a typical 1200 bps TNC or other data communications equipment.
- ON: Transmit data input (PKD) sensitivity is 2 Vp-p. This is suitable for most 9600 bps TNCs. Set Menu B, No. 77 to ON if using a TNC with dual speed capability that only has a 2 Vp-p output. However, in this case, FM mode must be used.

Using a modulator input level that is far different from the optimum 40 mVp-p / 2 Vp-p specifications may result in deterioration of S/N ratio or signal distortion. This could result in increased errors or a complete failure to connect with other stations.

If the modulator input level rises to approximately 4 Vp-p, the transceiver automatically switches to Receive to prevent transmitting a distorted signal. Transmission is not possible until the input level is reduced by adjusting the TNC modulation level.

To receive after making the necessary connections as explained in "PACKET EQUIPMENT" {page 5}, use the following procedure and refer to your TNC manual for further assistance.

- 1 Select the desired frequency.
- 2 Select the correct mode by pressing [AUTO/FM] or [SSB/CW].
- 3 Select the correct Menu B, No. 77 {page 14} selection based on the type of keying, transmission speed, and TNC that you are using (see charts).
- 4 Turn the **VOL** control clockwise to set a comfortable level if you plan to listen to the data exchanges. Otherwise, leave the control fully counterclockwise.
 - The **VOL** control setting does not affect the receive audio level from the DATA connector on the Rear Panel.
- 5 Adjust the **SQL** control until the "BUSY" indicator on the Display just disappears (threshold) while the frequency is clear of any activity.

After beginning to receive stations, use the **Main Tuning** control for minor frequency adjustments to compensate for frequency drift while watching the tuning indicator on your TNC. Do not use the **RIT** control since it is important to keep your receive and transmit frequencies equal.

To transmit, proceed to the subsequent steps.

- 6 Commands sent from your communications terminal (either a computer keyboard or a "dumb" terminal) to the TNC control your transceiver.
 - Refer to your TNC instruction manual.
 - Be courteous. Although packet protocol can handle multiple stations on a single frequency, overall throughput decreases due to packet collisions during busy times of the day. Keep transmissions short at these times.
- 7 Adjust the output level from the TNC while watching the RF meter to avoid output power saturation. Adjust for a maximum meter reading of 10 with a steady mark or space.

Note:

- ◆ *Inputting 9600 bps GMSK signals at too high a level or inputting significantly distorted signals into the transceiver can cause errors and a wide transmit bandwidth that may interfere with other stations.*
- ◆ *Always tune your transceiver to the exact frequency of the station you are contacting. Failure to do so will result in inaccurate demodulation of received packets and multiple retries. Use the **Main Tuning** control (-5 kHz to +5 kHz) for making fine adjustments as necessary.*

SSB OPERATION

To receive, use the following procedure:

- 1 Select the desired frequency.
- 2 Select the USB or LSB mode by pressing **[SSB/CW]**.
 - Either "USB" or "LSB" appears.
 - Each press of **[SSB/CW]** changes the mode from USB to LSB to CW in rotation, and displays the mode selected on the Display.



- 3 Set the **VOL** control to a comfortable listening level.
- 4 If the squelch will be used, select the type of squelch you want, and adjust as explained earlier {page 16}.

To transmit, proceed to the subsequent steps.

- 5 Listen. Make sure that your transmission won't interfere with others.
- 6 Press and hold **[PTT]** on the microphone.
- 7 Speak into the microphone.
 - Speak in a normal tone of voice. The RF meter should indicate from 7 to 9 on voice peaks when using High power. The meter will read lower when using the Low power. Speaking too close to the microphone, or too loudly may increase distortion and reduce intelligibility.
- 8 As you transmit, verify that the RF Meter is reading upscale confirming transmit output power. The microphone gain is controlled automatically; however, if you prefer to set the gain manually, refer to the following.
 - Microphone gain adjustment is via Menu B, Nos. 61 and 62 {page 14}. No. 61 toggles a circuit ON or OFF to maintain a constant level regardless of variations in your speech level. Turning No. 61 OFF sets the microphone gain to a fixed value. This fixed value is selected from No. 62 which allows you to control the gain over a 12 dB range with 5 discrete selections. Each selection is 3 dB higher than the previous with the default being the mid-range selection of 0 dB.



CW OPERATION

To receive, use the following procedure:

- 1 Select the desired frequency.
- 2 Select the CW mode by pressing **[SSB/CW]**.
 - "CW" appears.
 - Each press of **[SSB/CW]** changes the mode from USB to LSB to CW in rotation.



- 3 Set the **VOL** control to a comfortable listening level.
- 4 If the squelch will be used, select the type of squelch you want, and adjust as explained earlier {page 16}.

To transmit, proceed to the subsequent steps.

- 5 Listen. Make sure that your transmission won't interfere with others.
- 6 Begin sending using your key or keyer.
- 7 As you send, verify that the RF meter is reading upscale confirming transmit output power.



CW PITCH CHANGE

The CW receive pitch can be selected from within the range of 400 Hz to 1000 Hz in 50 Hz steps by changing Menu A, No. 02 {page 13}. The default is 800 Hz.

You may prefer selecting a higher pitch for easier copy through interference from other stations. When copying a strong signal on a clear frequency, you may find it more pleasant to select a lower pitch. Changing this setting does not affect the transmit sidetone.

CW KEYING DELAY

Menu A, No. 01 {page 13} allows keying delay time selection. This is the delay before the transceiver returns to the receive mode after the key is released. Various delay values are available. The default is 600 ms.

5 MEMORY FEATURES

MICROPROCESSOR MEMORY BACKUP

This transceiver uses a lithium battery to retain the user-specified memory items. Switching the power OFF will not erase the Menu Setups or memory channels. Lithium battery life is approximately 5 years.

If you find the transceiver powers-up with default settings, and channel and VFO data is erased, have the lithium battery replaced. Contact an authorized KENWOOD Service Facility or dealer.

MEMORY CHANNEL DATA

This transceiver has numerous memory channels for different purposes as follows:

- 50 simplex channels
- 49 split-frequency channels
- 1 Scan Limits channel
- 1 Call channel

Channel No.	Channel Type	Purpose
00 to 49	Simplex	Use for simplex or repeater communications.
50 to 98	Split-Frequency	Use for simplex, repeater, or half-duplex communications (different TX/RX frequencies).
99	Scan Limits	Stores the lower frequency limit and the upper frequency limit for tuning in VFO mode or for Program Scan.
Call Channel	Quick Recall	Use as a quick recall simplex memory channel.

The following can be stored in memory:

Parameter	Chans. 00 to 49	Chans. 50 to 98	Chan. 99	Call Channel
Receive frequency	Yes	Yes	Yes	Yes
Transmit frequency	N/A	Yes	N/A	N/A
Lower and upper Scan frequency	No	No	Yes	No
Modulation mode	Yes	Yes	Yes	Yes
Tone (CTCSS) frequency	Yes	Yes	Yes	Yes
Tone/CTCSS status (ON/OFF)	Yes	Yes	Yes	Yes
DTSS code	Yes	Yes	Yes	No
Offset status (+/-)	Yes	No	Yes	Yes
Reverse(ON/OFF)	Yes	No	Yes	Yes
AIP (ON/OFF)	Yes	Yes	Yes	Yes
Lock-out (ON/OFF)	Yes	Yes	Yes	No

Yes: Can be stored
 No: Cannot be stored
 N/A: Not applicable

Note:

- ◆ When changing Lock-out status after recalling any memory channel, the newly selected status is stored automatically in that memory channel.
- ◆ When changing stored data other than the lower frequency and upper frequency limits after recalling the Scan Limits channel 99, the new data is stored automatically in that channel.

MEMORY CHANNEL STORAGE

SIMPLEX CHANNEL STORAGE

Store the same transmit and receive frequency in any memory channel from 00 to 49 with this procedure.

- 1 Select a frequency, a modulation mode, and other data (as required) using VFO A.



- 2 Press [M.IN].

- The last memory channel selected appears.



- 3 Select a memory channel using the **Alternate Tuning** control or microphone [UP]/[DWN].

- Pressing [MHz] allows you to select from empty memory channels only. Pressing [MHz] again cancels this function.

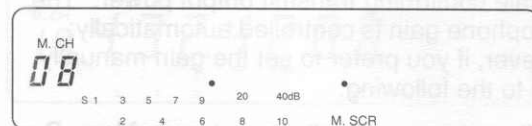

- 4 Press [M.IN] again.

- The data from VFO A is stored in the selected memory channel, and the transceiver returns to VFO mode.

Note: Pressing [M.IN] overwrites new data on any previous data in that channel.

SPLIT-FREQUENCY CHANNEL STORAGE

Store a different transmit frequency and receive frequency in any memory channel from 50 to 98 with this procedure.

- 1 Select the receive frequency, modulation mode, and other data (as required) using VFO A.



- 2 Press [CLR].
 - This step is optional. The purpose is to match the VFO A and VFO B frequencies. This will probably make selecting the VFO B frequency quicker.

- 3 Press [A/B] to select VFO B.
- 4 Select the transmit frequency using VFO B.



- 5 Press [A/B] to select VFO A.
 - The VFO selected here contains the frequency that will become the memory receive frequency after completing Step 8 below. The other VFO's frequency will become the memory transmit frequency.
- 6 Press [M.IN].
 - The last memory channel selected appears.
 - Pressing [MHz] allows you to select from empty memory channels only. Pressing [MHz] again cancels this function.
- 7 Select a memory channel using the **Alternate Tuning** control or microphone [UP]/[DWN].

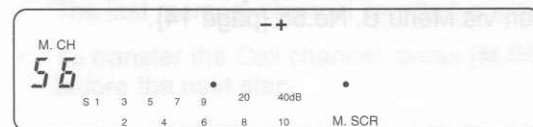

- 8 Press [M.IN] again.
 - The data selected in Steps 1 through 5 is stored in the selected memory channel, and the transceiver returns to the previous mode.

Note:

- ◆ Shift status and Reverse status cannot be stored in a split-frequency memory channel.
- ◆ Pressing [M.IN] overwrites new data on any previous data in that channel.

SCAN FREQUENCY LIMITS STORAGE

The lower and upper frequency limits for tuning in VFO mode or for Program Scan are stored in memory channel 99. Store these frequencies with this procedure.

- 1 Select the lower frequency limit, modulation mode and other data using VFO A.



- 2 Press [A/B] to select VFO B.
- 3 Select the upper frequency limit using VFO B.



- 4 Press [A/B] again to select VFO A.
- 5 Press [M.IN].
 - The last memory channel number selected appears.
- 6 Select memory channel 99 using the **Alternate Tuning** control or microphone [UP]/[DWN].
- 7 Press [M.IN] again.
 - The data selected in Steps 1 through 4 is stored in the selected memory channel, and the transceiver returns to VFO mode.

Note: Pressing [M.IN] overwrites new data on any previous data in that channel.

■ Programmable VFO Function

After programming a lower frequency limit and an upper frequency limit into memory channel 99, you can then select this channel while in Memory Recall and use the **Main Tuning** control to tune within the programmed range as if you were in VFO mode.

To confirm the current programmed range, press [F.LOCK], then press microphone [UP] and [DWN] to check the limits.

5 MEMORY FEATURES

CALL CHANNEL STORAGE

The Call channel can be used to store any frequency within your transceiver operating range. The Call channel always can be selected quickly. You may wish to dedicate the Call channel on a group-wide basis as an emergency channel only to be used for urgent communications. Regardless, it's always best to move to a different frequency after establishing contact to free-up the Call channel.

Store your desired frequency for the Call channel with this procedure.

- 1 Select a frequency, modulation mode, and other data (as required).



- 2 Press **[M.IN]**.

- The last memory channel number selected appears.

- 3 Select the Call channel using the **Alternate Tuning** control or microphone **[UP]/[DWN]**.

- The Call channel is selected as shown below:

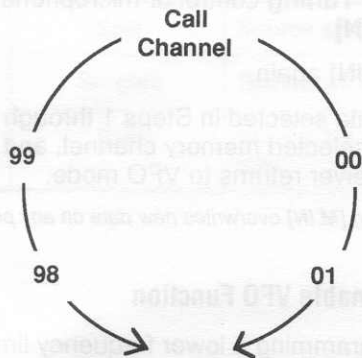

- 4 Press **[M.IN]** again.

- The data selected in Step 1 is stored in the Call channel, and the transceiver returns to VFO mode.

Note: Pressing **[M.IN]** overwrites new data on any previous data in that channel.

MEMORY CHANNEL RECALL

Recall a memory channel with the following procedure:

- 1 Press **[MR]** in VFO mode.

- The last memory channel selected appears.
- When recalling the Call channel, press **[M.IN]** to select Memory Scroll before the next step.



- 2 Select a memory channel using the **Alternate Tuning** control or microphone **[UP]/[DWN]**.

- Pressing **[MHz]** allows you to select only memory channels that contain data. Pressing **[MHz]** again cancels this function.
- If the Call channel was recalled, press **[CLR]** to exit Memory Scroll before the next step.



- 3 To return to VFO mode, press either **[A/B]**, or **[M>V]** if you wish to transfer the selected memory data to the VFO last selected.

Note: When using RIT with Memory Recall, the frequency shift as a result of RIT alters the memory channel frequency only temporarily. When RIT is turned OFF, the frequency actually stored in the memory channel is displayed. If RIT shifts the frequency outside the transceiver's frequency range, the frequency beyond the frequency limit is displayed; however, after RIT is turned OFF, the frequency stored in the memory channel is displayed.

TEMPORARY FREQUENCY CHANGE

It is possible to change the operating frequency by using the **Main Tuning** control without affecting the contents of the recalled memory channel. Select this operation via Menu B, No.55 (page 14).

MEMORY CONTENTS CONFIRMATION

The contents of a memory channel can be confirmed in VFO mode or Memory Recall with the following procedure without changing the receive frequency.

- 1 Press **[M.IN]** in VFO mode or Memory Recall.
 - "M.SCR" appears indicating Memory Scroll is selected.



- 2 Select the memory channel to be confirmed using the **Alternate Tuning** control or microphone **[UP]/[DWN]**.

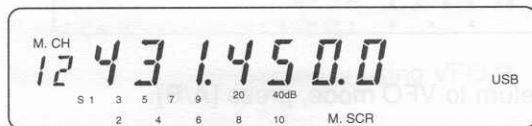

- 3 To return to the previous mode, press **[CLR]**.
 - When you select Memory Scroll, you can transfer data from one memory to another. Refer to page 28.

Note: If you select a split-frequency channel, you cannot confirm the transmit frequency and transmit modulation mode using this method. Also this method cannot be used to confirm the contents of memory channel 99. Refer to "CONFIRMING LOWER/UPPER FREQUENCY LIMITS" (page 31).

MEMORY TRANSFER

MEMORY/CALL CHANNEL → VFO

Transfer the contents of memory channels 00 to 99, or the Call channel contents, to the current VFO with the following procedure:

- 1 Press **[MR]** to change from VFO mode to Memory Recall.
 - The last memory channel selected appears.
 - To transfer the Call channel, press **[M.IN]** before the next step.



- 2 Select a memory channel using the **Alternate Tuning** control or microphone **[UP]/[DWN]**.

- 3 Press **[M>V]**.
 - The displayed data is transferred to the VFO, and VFO mode is restored. It is now possible to change the frequency or any other setting.
 - Pressing **[M>V]** clears the current VFO data, but the memory channel data remains unchanged.



The following chart shows how transmit and receive frequencies are transferred:

VFO Selected BEFORE Pressing M>V Button	Type of Memory Channel	VFO Contents AFTER Pressing M>V Button	
		VFO A	VFO B
VFO A	Simplex Channel or Channel 99	Simplex Channel data or Channel 99 data	No Change
	Split Channel	Split Memory Channel RX data	Split Memory Channel TX data
VFO B	Simplex Channel or Channel 99	No Change	Simplex Channel data or Channel 99 data
	Split Channel	Split Memory Channel TX data	Split Memory Channel RX data

Note:

- ◆ When **[M > V]** is pressed after you have temporarily changed the contents of the recalled channel, the currently displayed data is transferred to the VFO.
- ◆ Automatic Offset takes priority over the transferred shift status. However, the transferred modulation mode overrides the Automatic Modulation function.

5 MEMORY FEATURES

TRANSFER OF TEMPORARY DATA

It is possible to alter the displayed data after recalling a memory channel if Menu B, No. 55 is ON. The default is OFF. The changed data can be considered "temporary" since it has not been stored in any memory. You can then transfer the temporary data to another memory channel with the following procedure:

- 1 Recall the desired memory channel.
 - Refer to "MEMORY CHANNEL RECALL" {page 26}.
- 2 Edit the displayed data as required.
- 3 Press **[M.IN]** to select Memory Scroll.
- 4 Select a memory channel to which the data will be transferred, using the **Alternate Tuning** control or microphone **[UP]/[DWN]**.
- 5 Press **[M.IN]**.
 - The data is transferred and the previous mode is restored.

The following chart shows how transmit and receive frequencies are transferred:

Source Memory Data	Destination Memory Channel	Destination Memory Contents AFTER Pressing M>V Button
Simplex	Simplex	Source simplex data
	Split	Source simplex data
Split	Simplex	Source RX data
	Split	Source RX and TX data

ERASING MEMORY CHANNELS

Erase the contents of any memory channel with the following procedure:

- 1 Recall the memory channel to be erased.



- 2 Press **[CLR]** (2 s).

- The memory channel is erased as indicated by the clearing of the displayed frequency.

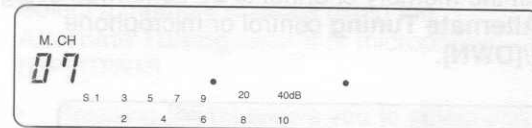

- 3 To return to VFO mode, press **[A/B]**.

FULL RESET

Do a Full Reset if you want to erase all data in all memory channels or a Partial Reset {page 34} does not correct a problem you are experiencing. Remember that a Full Reset requires that you reenter any memory channel data again after the initialization if you wish to use those channels. On the other hand, initialization is a quick way to erase all data from all channels.

Press **[MR]+ POWER ON**.



6 SCAN

Scan is a useful feature for hands-off monitoring of your favorite frequencies. After becoming comfortable with how to use all types of Scan, the monitoring flexibility gained will increase your operating efficiency.

This transceiver provides 3 types of Scan as follows:

Scan Type	Purpose
Memory Scan	Quick activity update of your favorite frequencies.
Program Scan ¹	General update of activity on the entire band or a sub-section of the band while in VFO mode.
VFO/ Memory/ Call Scan	Check the current VFO, Memory Recall, and Call channel frequencies in rotation.

¹ Program Scan has several variations available {page 31}.

Note:

- ◆ Remember to adjust the squelch threshold level {page 16} before using Scan.
- ◆ Always turn OFF Tone Alert and Page before using Scan.
- ◆ For CTCSS operation, Scan stops and the squelch opens only for signals that contain the same CTCSS tone that is stored in your transceiver.
- ◆ For DTSS operation, Scan stops for any signal received; however, the squelch opens only for signals that contain the same DTSS code that is stored in your transceiver.
- ◆ When both CTCSS and DTSS are ON, Scan stops for signals that contain the matching CTCSS tone. However, the squelch opens only when the matching DTSS code is received.

BUSY-FREQUENCY STOP

When a signal is received while using Program Scan, the transceiver automatically stops scanning when a signal is detected if Busy-frequency Stop is ON. The transceiver remains on the same frequency for either a short time or until the signal drops depending on which Scan Resume method is selected. The squelch must be adjusted to the noise threshold point with no signals present.

The Busy-frequency Stop function can be turned ON or OFF via Menu A, No. 03 {page 13}. The default is ON.

SCAN RESUME METHODS

Time-operated mode: Scan resumes approximately 6 seconds after stopping on a busy frequency regardless if the signal is still present.

Carrier-operated mode: Scan does not resume until approximately 2 seconds after the signal drops.

Select the Scan Resume method via Menu A, No. 04 {page 13}. The factory default is the Time-operated mode (0).

Note: For Scan to stop, the **SQL** control must be set just beyond the threshold where the background noise disappears when no signal is present.

SCAN HOLD

Busy-frequency Stop is useful primarily when operating in a full-carrier mode such as FM. An alternative to Busy-frequency Stop that works especially well for SSB or CW is Scan Hold. Scan Hold only stops the transceiver from scanning when you turn the **Main Tuning** control, turn the **Alternate Tuning** control, or press microphone **[UP]/[DWN]**. Scan stops on the current frequency and resumes a short time later.

Enable Scan Hold via Menu B, No. 56 {page 14}. The default is OFF.

Note: Busy-frequency Stop must be turned OFF to use Scan Hold.

6 SCAN

MEMORY SCAN

Memory Scan can be used to scan only a specific channel group (Group Scan), or to scan all memory channels containing data (All-channel Scan). Selection of the desired method is via Menu A, No. 05 (page 13). The default is Group Scan (OFF).

GROUP SCAN

There are 100 memory channels total, divided into groups of 10 channels each (00 to 09, 10 to 19, ..., 90 to 99). When Group Scan is selected, the transceiver scans only memory channels that belong to the specified group and contain data.

- 1 Press **[MR]** to select Memory Recall.
 - The last memory channel selected appears.
- 2 Select any memory channel belonging to the desired group using microphone **[UP]** or **[DWN]**.



- 3 Adjust the **SQL** control while no signal is present.
- 4 Press **[SCAN]**.
 - The scan speed appears with "SCAN", and Scan starts.
 - To change channel groups while scanning, press microphone **[UP]/[DWN]**.
 - To change the scan direction, turn the **Alternate Tuning** control clockwise or counterclockwise.



- 5 Press **[SCAN]**, **[CLR]**, or the microphone **[PTT]** to stop Scan.
 - Memory Recall is restored.
- 6 To restore VFO mode, press **[A/B]**.

Note: If no data is stored in the memory channels of the specified group, or all memory channels are locked out, pressing **[SCAN]** will sound the Morse code "CHECK" reminder.

ALL-CHANNEL SCAN

The All-channel Scan function scans all memory channels containing frequency data.

- 1 Press **[MR]** to select Memory Recall.
 - The last memory channel selected appears.



- 2 Adjust the **SQL** control while no signal is present.
 - Remember, Menu A, No. 05 must be ON.
- 3 Press **[SCAN]**.
 - The scan speed appears with "SCAN", and scan starts.
 - To change the scan direction, turn the **Alternate Tuning** control clockwise or counterclockwise.



- 4 Press **[SCAN]**, **[CLR]**, or the microphone **[PTT]** to stop Scan.
 - Memory Recall is restored.
- 5 To restore VFO mode, press **[A/B]**.

Note: If no data is stored in the memory channels, or all memory channels are locked out, pressing **[SCAN]** will sound the Morse code "CHECK" reminder.

MEMORY CHANNEL LOCK-OUT

Memory channels that you prefer not to monitor while scanning can be locked-out. Lock-out any memory channel with the following procedure:

- 1 Press **[MR]** to select Memory Recall.
 - 2 Select the memory channel to be locked-out using the **Alternate Tuning** control or microphone **[UP]/[DWN]**.
- 3 Press **[CLR]**.
 - A dot appears beside the memory channel number to indicate the channel has been locked-out.
 - Pressing **[CLR]** for more than 2 seconds erases the contents of the memory channel.



- 4 To restore the VFO, press **[A/B]**.
 - The dot disappears.

Lock-out for an individual channel can be canceled by repeating the above procedure.

PROGRAM SCAN

The Program Scan function scans the range between the lower limit frequency and upper limit frequency stored in memory channel 99. Scan always begins scanning upwards in frequency but can be reversed by turning the **Main** or the **Alternate Tuning** control, or by pressing microphone **[UP]/[DWN]**. Turning either control counterclockwise causes Scan to move downwards in frequency while turning either control clockwise causes Scan to move upwards in frequency. Similarly, pressing microphone **[UP]** or **[DWN]** causes Scan to move in the same direction as the button labels. Menu B, No. 56 must be OFF if the controls are to function in this manner.

For a refresher on how to store the Scan Limits, refer to "SCAN FREQUENCY LIMITS STORAGE" {page 25}.

Program Scan can be broken down into 3 kinds of scan method.

Type of Program Scan	Purpose
Basic Scan	General update of activity on a selected portion of the band. This is a sub-set of all frequencies tuned during Band Scan.
Band Scan	Monitor all frequencies tuned by the transceiver.
MHz Scan	Monitor any single 1 MHz range of frequencies.

CONFIRMING LOWER/UPPER FREQUENCY LIMITS

The lower and upper Scan frequency limits stored in memory channel 99 can be confirmed with the following procedure:

- 1 Press **[MR]** to select Memory Recall.
- 2 Select memory channel 99 using the **Alternate Tuning** control or microphone **[UP]/[DWN]**.



- 3 Press **[F.LOCK]**.
 - "F.LOCK" appears.



- 4 Display the lower limit frequency by pressing microphone **[DWN]** and the upper limit frequency by pressing microphone **[UP]**.
- 5 Press **[F. LOCK]**, and then **[A/B]** to restore VFO mode.

BASIC SCAN

When the lower limit frequency and upper limit frequency are stored in memory channel 99, the transceiver scans this range.

- 1 Press **[A/B]** to select VFO mode.
- 2 Select a frequency that is between the lower and upper frequency limits stored in memory channel 99.
- 3 Adjust the **SQL** control while no signal is present.
- 4 Press **[SCAN]**.
 - The transceiver scans upwards from the current operating frequency.
 - To change the scan direction, use the **Main Tuning** control, **Alternate Tuning** control or microphone **[UP]/[DWN]**.



- 5 Press **[SCAN]**, **[CLR]**, or microphone **[PTT]** to stop scanning and restore VFO mode.

Note: The modulation mode can be changed while scanning.

BAND SCAN

If the lower limit frequency and upper limit frequency have not been stored in memory channel 99, or if the current VFO frequency is outside the range bracketed by the Scan Limits in memory channel 99, the transceiver scans the entire band.

- 1 Press **[A/B]** to select VFO mode.
- 2 Press **[SCAN]**.
 - The transceiver scans upwards from the current operating frequency.
 - To change the scan direction, use the **Main Tuning** control, **Alternate Tuning** control or microphone **[UP]/[DWN]**.



- 3 Press **[SCAN]**, **[CLR]**, or microphone **[PTT]** to stop scanning and restore VFO mode.

Note: The modulation mode can be changed while scanning.

6 SCAN

MHz SCAN

MHz Scan directs the transceiver to scan a specified 1 MHz range of frequencies. The range is determined by the 1 MHz digit of the currently selected frequency. For example, when the current frequency is 436.680 MHz and the frequency step is 25 kHz, the scan range is from 436.000 to 436.975 MHz.

- Press **[MHz]** while scanning with Basic Scan or Band Scan.
 - The transceiver scans upwards from the current operating frequency.
 - To change the scan direction, use the **Main Tuning** control, **Alternate Tuning** control or microphone **[UP]/[DWN]**.



- Press **[MHz]** again to restore the previous scan type.

Note: The modulation mode can be changed while scanning.

VFO/MEMORY/CALL SCAN

This combination scan monitors the current VFO frequency, the memory channel recalled last, and the Call channel.

- Press **[CALL]** to select the Call channel.
- Press **[SCAN]**.
- Scan checks in rotation the Call channel, VFO frequency, and the memory channel last used.
 - If the memory channel selected last has no frequency stored, Scan skips over the memory channel and only scans the Call channel and the VFO frequency.
 - Locked-out memory channels are not skipped.
- Press **[SCAN]**, **[CLR]**, or the microphone **[PTT]** to stop scanning.
 - The transceiver stays in the current mode.

SETTING SCAN SPEED

Scan speed can be changed through 9 steps using the **RIT** control. A weight value of the form "PN" appears on the Display during Scan. "N" is a number from 1 to 9 that acts as a speed reference number. Turning the **RIT** control clockwise decreases the scan speed, and counterclockwise increases the speed.

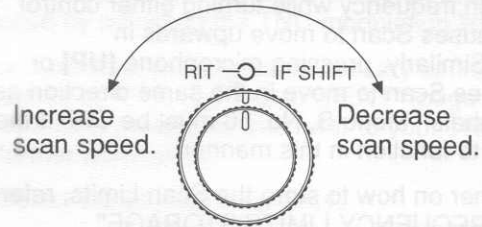

The Program Scan scan speed can be set independently from Memory Scan and VFO/Memory/Call Scan. The same weight value selected while in Memory Scan or VFO/Memory/Call Scan represents the same scan speed; however, this is not true for Program Scan.



Note: Remember to center the **RIT** control when finished scanning to avoid confusion later when **RIT** is used to vary the receiver frequency.

This chart shows the time required for the transceiver to move either 1 step or 1 memory channel depending on which type of scan is selected. When Busy-frequency Stop (Menu A, No. 03) is ON (default), the SSB step size is 1 kHz and the FM step size is 20 kHz while using Program Scan. When Busy-frequency Stop is OFF, the SSB step size is 10 Hz and the FM step size is 100 Hz.

Weight Value	Program Scan (msec)	Memory Scan (sec)
1	20	0.4
2	70	1.8
3	110	3.2
4	160	4.6
5	200	6.0
6	250	7.5
7	300	9.0
8	350	10.5
9	400	12.0

7 AUXILIARY FUNCTIONS

The functions described in this section are called "auxiliary" since none of the functions are mandatory to use in order to contact other stations on any of the modes. In some cases, only top-of-the-line equipment used to include some of these functions. Learning these functions will make operating more enjoyable for those plagued by difficult operating conditions, such as man-made interference, or for those privileged to have a crowded band due to strong propagation. Some functions improve on the convenience of an already easy-to-use transceiver by allowing remote control of frequently-used functions via the microphone keys.

RECEIVING

RECEIVER INCREMENTAL TUNING (RIT)

RIT provides the ability to vary your receive frequency by either ± 1.1 kHz using 10 Hz steps or ± 2.2 kHz using 20 Hz steps without changing your transmit frequency. The tuning range is selected via Menu B, No. 57 [page 14]. The default is ± 1.1 kHz. RIT works equally well with all modulation modes and while using VFO mode, Memory Recall, or the Call channel. This function is especially useful while operating SSB to maintain the best audio when the other station is drifting in frequency, for example. While operating CW, combining RIT and IF Shift functions is a quick way to avoid adjacent frequency interference.

1 Press **[RIT]**.

- "RIT" and the shift frequency value appear.



2 Turn the **RIT** control to change your receive frequency.

- As the control is turned, the new frequency shift updates simultaneously both the RIT display and the transceiver frequency display in 100 Hz steps.

3 To switch off the RIT function, press **[RIT]**.

It's a good habit to turn OFF the RIT function after a contact is finished. This returns the receive frequency to the transmit frequency. It ensures that you don't listen by mistake on a different frequency from your transmit frequency on the next contact. When using Memory Recall, RIT only functions with a memory channel containing stored data. Since an empty channel contains no receive frequency, RIT cannot function.

IF SHIFT

IF Shift functions only in the SSB or the CW mode. This allows you to shift the IF filter pass band without changing the receive frequency.

When the IF pass band is shifted, as shown in the diagram, it is possible to reduce or completely eliminate adjacent frequency interference.

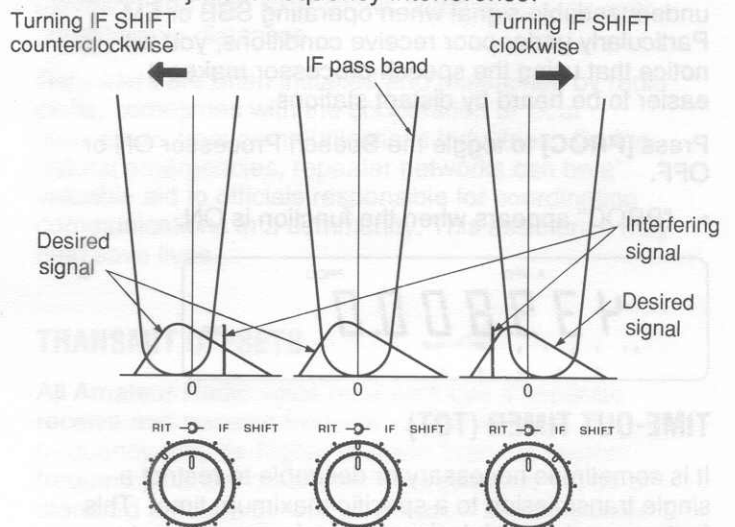

Turn the **IF SHIFT** control clockwise to eliminate an interfering signal lower than your receive frequency. This attenuates interference lower in frequency. Turn the **IF SHIFT** control counterclockwise to eliminate an interfering signal higher than your receive frequency. This attenuates interference higher in frequency.

After using IF Shift, return the control to the center detent position to select the normal pass band.

NOISE BLANKER

The Noise Blanker was designed to reduce pulse noise such as that generated by automobile ignitions.

Press **[NB]** to toggle the Noise Blanker ON or OFF.

- "NB" appears when the function is ON.
- When receiving a strong signal while the Noise Blanker is ON, receive audio may sound distorted. This is due to a "pumping" action caused by the strong signal. If the signal is strong enough to cause pumping, it is unlikely that the blanker would be required anyway. Therefore, eliminate this distortion by switching OFF the Noise Blanker.

ADVANCED INTERCEPT POINT (AIP) FUNCTION

AIP helps eliminate interference and reduce audio distortion that is sometimes caused by the presence of strong signals due to the high receiver sensitivity. It is especially useful during contest-type conditions on an extremely crowded band or when propagation is at a peak and all signals seem to be local quality.

Press **[AIP]** to toggle the AIP function ON or OFF.

- "AIP" appears when the function is ON.

7 AUXILIARY FUNCTIONS

TRANSMITTING

SPEECH PROCESSOR

The speech processor functions by leveling the large fluctuations in your voice that are present when you speak. This leveling action effectively raises the average transmit output power resulting in a more understandable signal when operating SSB or FM. Particularly under poor receive conditions, you will notice that using the speech processor makes it easier to be heard by distant stations.

Press **[PROC]** to toggle the Speech Processor ON or OFF.

- "PROC" appears when the function is ON.



TIME-OUT TIMER (TOT)

It is sometimes necessary or desirable to restrict a single transmission to a specific maximum time. This feature can be useful when accessing repeaters to prevent repeater time-outs as a result of a single transmission that is longer than the maximum permitted time. The Time-out Timer also prevents your transceiver from damage due to excessive uninterrupted transmissions. If you are trying to conserve battery power, TOT helps with that task too.

Activate TOT via Menu B, No. 59 {page 14} anytime you wish to limit your transmit time. There are 5 different timer values available. The default for the function is OFF. When TOT times out, the transceiver beeps and automatically returns to Receive. To resume transmitting, release and then press **[PTT]** again.

OPERATOR CONVENIENCES

MICROPROCESSOR RESET

If your transceiver seems to be malfunctioning, initializing the microprocessor and its memory may resolve the problem.

■ Initial Settings

	Frequency ¹ (MHz)	Modulation Mode
TM-255A/E	144.000.0 MHz	CW
TM-455A U.S.A. Canada	430.000.0 MHz	FM
TM-455E Europe	430.000.0 MHz	CW ²
Memory Channel	—	—

¹ Both VFO A and VFO B

² Some versions: FM

■ Partial Reset

Do a Partial Reset if a button or control does not function according to the instructions provided in this manual. A Partial Reset does not erase any data in memory channels.

Press **[A/B]+ POWER ON**.

■ Full Reset

Do a Full Reset if you want to erase all data in all memory channels or a Partial Reset does not correct a problem you are experiencing. Remember that a Full Reset requires that you re-enter any memory channel data again after the initialization if you wish to use those channels. On the other hand, initialization is a quick way to erase all data from all channels.

Press **[MR]+ POWER ON**.

REMOTE FUNCTIONS USING THE MICROPHONE

The 4 keys located on the face of the microphone and labeled [PF], [MR], [VFO], and [CALL] are called the Programmable Function (PF) keys. Though labeled with their default functions, each key can be reassigned by the operator to perform remote functions conveniently from the microphone.

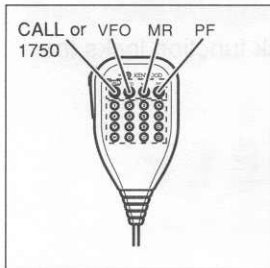

MC-45DM/45DME

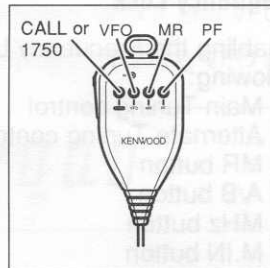

MC-45/45E

Functions that can be assigned to the microphone PF keys include the following:

- Front Panel buttons
- Menu A or B
- Special Functions: Functions not available on the Front Panel

No.	Menu A	No.	Front Panel	No.	Menu B
00	Menu 00	20	A/B (VFO)	50	Menu 50
01	Menu 01	21	AIP	51	Menu 51
02	Menu 02	22	AUTO/FM	52	Menu 52
03	Menu 03	23	Tone Alert	53	Menu 53
04	Menu 04	24	CALL	54	Menu 54
05	Menu 05	25	CLR	55	Menu 55
06	Menu 06	26	CODE	56	Menu 56
07	Menu 07	27	DTSS	57	Menu 57
08	Menu 08	28	F	58	Menu 58
		29	F.LOCK	59	Menu 59
		30	LOW	60	Menu 60
		31	MHz	61	Menu 61
		32	M.IN	62	Menu 62
		33	MR	63	Menu 63
		34	M > V	64	Menu 64
		35	NB	65	Menu 65
		36	PROC	66	Menu 66
		37	REV	67	Menu 67
		38	RIT	68	Menu 68
		39	SCAN	69	Menu 69
		40	SHIFT	75	Menu 75
		41	SSB/CW	77	Menu 77
		42	TONE	78	Menu 78

Note: The function of the [1750] key on the MC-45E and MC45DME cannot be changed.

No.	Special Function
80	AF MUTE Disables the audio output while the key is held down.
81	AF ATT Reduces the audio level while the key is held down.
82	MONITOR Opens the squelch while the key is held down.
83	MENU ACCESS Selects the Menu mode.
84	ENTER Used with the DTMF microphone keypad for direct entry of the operating frequency or memory channel.
85	VOICE Activates the Voice synthesizer (VS-2 option).
86	TF-SET Displays the transmit frequency in Receive while the key is held down.
87	△ F Similar to TF-SET except displays the difference of the transmit frequency from the receive frequency while the key is held down.

■ **Configuring Microphone PF Keys**

Key Label	General Key Name	Menu Function	Default Function
PF	PF1	Menu B, No. 70	Menu Access (83)
MR	PF2	Menu B, No. 71	Memory Recall (33)
VFO	PF3	Menu B, No. 72	VFO Select (20)
CALL	PF4	Menu B, No. 73	Call Channel (24)

- 1 Select the menu number from the chart above that corresponds with the PF key you want to program.
- 2 Select the number that corresponds to the function that you want to assign to the PF key.
 - Press [F.LOCK] or microphone [UP] to increment the function number.
 - Press [LOW] or microphone [DWN] to decrement the function number.
 - The function ranges are as follows:
 - 00-08: Menu A
 - 20-42: Front Panel keys
 - 50-78: Menu B
 - 80-87: Special Functions
 - 99: No assigned function
- 3 Press [F] or [CLR] to complete the setting.

7 AUXILIARY FUNCTIONS

■ Using the ENTER Function

- Press the microphone key that has been programmed with the ENTER function {page 35}.
 - The frequency template is displayed in the format "-.-.-.-" representing the 1 MHz digit down to the 100 Hz digit.

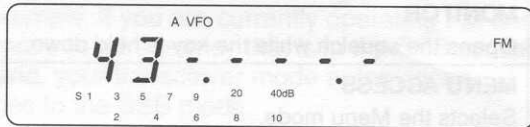

- Input the desired frequency sequentially starting with the 1 MHz digit using the microphone DTMF numeric keypad.
 - After the 100 Hz digit is entered, input mode automatically ends.
 - Pressing the ENTER function key during input mode causes a zero to be entered in subsequent digits not entered yet.

PROGRAMMABLE FUNCTION (PF) BUTTON

The Front Panel has a Programmable Function button in the upper right corner of the panel. This button is similar to the microphone PF keys since it can be assigned a function by the operator. The same functions that can be assigned to the microphone PF keys can also be assigned to the Front Panel PF button. Refer to "REMOTE FUNCTIONS USING THE MICROPHONE {page 35}".

- Select Menu B, No. 74 {page 14}.
- Select the number that corresponds to the function that you want to assign to the PF key {page 35}.
 - Press **[F.LOCK]** or microphone **[UP]** to increment the function number.
 - Press **[LOW]** or microphone **[DWN]** to decrement the function number.
 - The function ranges are as follows:
 - 00-08: Menu A
 - 20-42: Front Panel keys
 - 50-78 Menu B
 - 80-87: Special Functions
 - 99: No assigned function
 - The default is Voice Synthesizer (85).
- Press **[F]** or **[CLR]** to complete the setting.

LOCK FUNCTIONS

Occasionally, you may want to lock the buttons, keys and the **Tuning** controls to prevent accidentally changing any transceiver settings. This transceiver has several lock functions to provide maximum flexibility.

■ Frequency Lock

Enabling the Frequency Lock function locks the following:

- Main Tuning control
- Alternate Tuning control
- MR button
- A/B button
- MHz button
- M.IN button
- M>V button
- SCAN button
- CLR button
- SHIFT button
- TONE button
- REV button
- AUTO/FM button
- SSB/CW button
- CALL button
- Microphone UP/DWN
- Microphone PF2/PF3/PF4 keys

The following controls and buttons are not affected by enabling Frequency Lock:

- VOL/SQL controls
- RIT/IF SHIFT controls
- F button
- RIT button
- LOW button
- PROC button
- AIP button
- NB button
- PF button
- Microphone PTT switch
- Microphone PF1 key
- Microphone DTMF keypad
- Microphone Lock switch

Activate Frequency Lock with the following procedure:

Press **[F.LOCK]**.

- "F.LOCK" appears when Frequency Lock is ON.
- Each press of **[F.LOCK]** toggles the function ON and OFF.



■ **Main Unit Lock**

This transceiver allows you to separate the Front Panel from the Main Unit so you can mount the Front Panel in the most convenient location for operating. The Main Unit could be placed in a vehicle trunk, for example, since there are few buttons or controls on it. If you separate the two sections in this way, you may want to lock the Main Unit buttons and the **Main Tuning** control. These can be locked via Menu B, Nos. 68 and 69 {page 14}. The default for both menus is OFF (unlocked).

Menu B, No. 68 locks or unlocks the **Main Tuning** control. Furthermore, No. 68 has 2 types of lock. It can lock the **Main Tuning** control only if FM mode is selected ("F3") or if any mode is selected ("All"). Menu B, No. 69 locks or unlocks [**PROC**], [**AIP**], [**NB**], and [**PF**].

■ **Microphone Lock**

The Microphone Lock function disables everything on the microphone except [**PTT**] and, if equipped, the DTMF keypad.

Slide the Lock switch on the rear of the microphone to "LOCK" to activate Microphone Lock.

- Slide the Lock switch to the opposite position when you want to unlock the microphone buttons and keys.

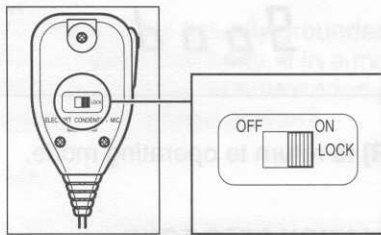

AUTOMATIC POWER OFF (APO)

Automatic Power Off is a background function that monitors whether any buttons have been pressed or controls have been changed. If 3 hours pass without either of the preceding, this function turns OFF the power. The purpose is to save power during unattended operation. However, 1 minute before the power turns OFF, "APO" starts blinking and a series of warning tones sound. Pressing any button or turning a control during this series of tones stops the shutdown process and resets the timer.

The function is disabled while scanning or while accessing either Menu A or B. Activate APO via Menu B, No. 58. To restore power after APO activates, press [**POWER**] twice.

Note: APO turns OFF the power if no key entry is made for 180 minutes even if Tone Alert is ON.

CHANNEL DISPLAY

When this function is switched ON, the transceiver data in Memory Recall is displayed by channel numbers without showing the associated frequencies.

Channel Display is selected via Menu B, No. 75. The default is Frequency Display (ON).

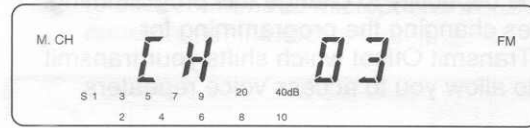

TRANSVERTER FREQUENCY DISPLAY

A transverter is a device that converts a range of frequencies applied to the input of the transverter to a different range of frequencies. The transverter's output can be applied to a transceiver's input, and then the transceiver is used to operate on the new frequency range.

The Display of this transceiver can be changed to show frequencies in the 1200 or 2400 MHz band via Menu B, No. 76. The default is OFF. The new ranges of frequencies that can be tuned in bands of 1 MHz are 1240 to 1299 MHz or 2400 to 2449 MHz.

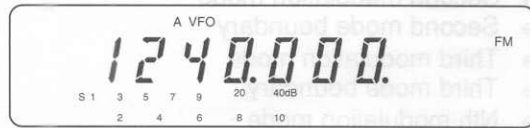

Note: Direct entry of frequency is not possible while using the Transverter Frequency Display function.

PEAK METER HOLD

This function adds a 2.5 second delay after the S/RF meter reaches its peak value before dropping back to 0. The purpose of this delay is to allow the operator a better chance to read the peak value.

Peak Meter Hold is selected via Menu B, No. 54. The default is ON.

7 AUXILIARY FUNCTIONS

REPROGRAMMING AUTO MODE/AUTO OFFSET

As explained under "AUTOMATIC MODE SELECTION" {page 18}, Automatic Mode allows the transceiver to choose automatically the correct modulation mode based on the currently selected frequency. Although your transceiver is initially programmed according to international agreements, you have the capability to change this programming. This includes changing the programming for Automatic Transmit Offset which shifts your transmit frequency to allow you to access voice repeaters {page 19}.

Before beginning to reprogram, draw a simple diagram as shown below to represent the new plan that you want to store in the transceiver. Substitute actual frequencies and modes in place of the variables shown. When you have your drawing complete, programming will take only a few minutes.

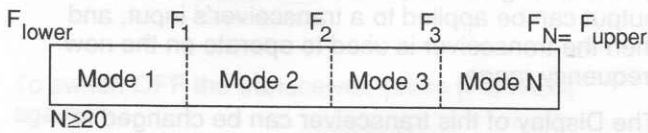

- F_{lower} → Transceiver's lower frequency limit
- Mode 1 → First modulation mode
- F_1 → First mode boundary
- Mode 2 → Second modulation mode
- F_2 → Second mode boundary
- Mode 3 → Third modulation mode
- F_3 → Third mode boundary
- Mode N → Nth modulation mode
- F_N → Nth mode boundary
- F_{upper} → Transceiver's upper frequency limit

1 Press [AUTO/FM]+ POWER ON.

- Menu No. 01 appears.



2 Enter the first mode boundary frequency (F_1).

- [F.LOCK] or microphone [UP] or Main Tuning CW → Increments frequency
- [LOW] or microphone [DWN] or Main Tuning CCW → Decrements frequency
- Mode boundary frequencies must be 10 kHz or more than the boundary stored in the previous menu number. Menu No. 01 frequency must be 10 kHz or more than the transceiver lower limit frequency. All mode boundary frequencies must be less than the transceiver's upper frequency limit.

3 Select the first mode (Mode 1) using [AUTO/FM] or [SSB/CW].

- If SSB or CW is selected in this step, jump to Step 5.

- 4 Select the transmit offset you want for this portion of the band using [SHIFT].
 - Transmit offset can only be set if FM mode was selected in Step 3.
- 5 If you have entered all the mode boundary frequencies you want to program, jump to Step 6. Otherwise, increment the menu number using the **Alternate Tuning** control and jump to Step 2 to enter the next mode boundary frequency, mode, and transmit offset, when necessary.
 - Menus greater than the menu number that contains the transceiver's upper frequency limit are ignored by the transceiver.
- 6 Select Menu No. 00 using the **Alternate Tuning** control.



7 Press [F.LOCK], [LOW], or microphone [UP] or [DWN].

- The data is recorded. The Display shows "good" if the data was recorded correctly otherwise "error" appears. If "error" appears, repeat Steps 6 and 7.



8 Press [CLR] to return to operating mode.

KEY CONFIRMATION BEEP TONE

The Beep Tone function provides a beep to provide feedback each time a button is pressed. If you prefer, this beep tone can be disabled via Menu B, No. 50. The default is ON.

The volume of the beep level can be changed via Menu A, No. 08. The default for the volume is High (H). This setting also affects the levels of the CW sidetone and the VS-2 Voice Synthesizer option.

Note: There is an interaction between the setting of Menu A, No. 08 and the VOL control. The VOL control must be at 12 o'clock or higher before the effect of the menu setting can be noticed.

MODULATION MODE AUDIBLE INDICATOR

This handy function alerts you audibly by either Morse code or a single beep each time a new modulation mode is selected. When Morse code is selected, the first letter of the selected mode is sent as a confirmation signal.

Select the audible indicator you prefer via Menu B, No. 51 {page 14}. The default is Morse code (ON).

Modulation Mode	Morse Code Letter
AUTO	• -
FM	• • - •
USB	• • -
LSB	• - • •
CW	- - • •

MORSE CODE ALARM OUTPUT

The Morse Code Alarm will alert you automatically in the following cases:

- Attempting to search for a memory channel if all memory channels are empty.
- Attempting to search for an empty memory channel if there are no free memory channels.
- Pressing **[SCAN]** while the transceiver is in a mode that does not allow Scan to be initiated.

Menu B, No. 52 allows you to select either Morse Code or Beep output for this function. When Morse Code is selected, the word "CHECK" is sent as the alarm signal. The default is Morse Code (ON).

DISPLAY DIMMER

Display Brightness is selected using Menu A, No. 00. There are 4 levels of illumination plus OFF. The default is d2 (second brightest illumination).

Ch	Freq	Mode	Band	Power	Priority
01	147.0	FM	147.0	100.0	1
02	147.5	FM	147.5	100.0	2
03	148.0	FM	148.0	100.0	3
04	148.5	FM	148.5	100.0	4
05	149.0	FM	149.0	100.0	5
06	149.5	FM	149.5	100.0	6
07	150.0	FM	150.0	100.0	7
08	150.5	FM	150.5	100.0	8
09	151.0	FM	151.0	100.0	9
10	151.5	FM	151.5	100.0	10

8 CONTINUOUS TONE CODED SQUELCH SYSTEM (CTCSS)

The CTCSS feature is available only when the TSU-8 CTCSS unit is installed. Also, CTCSS can only be activated when using FM mode.

CTCSS functions by using subaudible tones that are superimposed by a transmitter on a transmitted signal to control a receiver's squelch. When used in combination with the noise squelch, CTCSS provides a simple method to selectively choose which stations will be heard. This transceiver offers a total of 38 standardized CTCSS frequencies.

Monitoring is less tiring when using CTCSS since you hear only those stations on a particular frequency that are transmitting the CTCSS tone that you have selected.

SELECTING CTCSS FREQUENCIES

The CTCSS frequency is selected via Menu B, No.53 {page 14}. The available frequencies are listed below:

No.	Freq. (Hz)	No.	Freq. (Hz)	No.	Freq. (Hz)	No.	Freq. (Hz)
01	67.0	11	97.4	21	136.5	31	192.8
02	71.9	12	100.0	22	141.3	32	203.5
03	74.4	13	103.5	23	146.2	33	210.7
04	77.0	14	107.2	24	151.4	34	218.1
05	79.7	15	110.9	25	156.7	35	225.7
06	82.5	16	114.8	26	162.2	36	233.6
07	85.4	17	118.8	27	167.9	37	241.8
08	88.5	18	123.0	28	173.8	38	250.3
09	91.5	19	127.3	29	179.9		
10	94.8	20	131.8	30	186.2		

Note: The frequency selected via Menu B, No. 53 for CTCSS operation is also used for Tone access of repeaters. After using CTCSS, remember to select the correct Tone frequency before trying to access a repeater that requires a subaudible tone. Saving the correct Tone frequency along with the repeater frequency pair in a memory channel for each repeater you use will take care of this situation.

USING CTCSS

To switch ON CTCSS, repeatedly press [TONE] until both "TONE" and "CTCSS" appear on the Display. Each press of [TONE] switches the transceiver as follows:

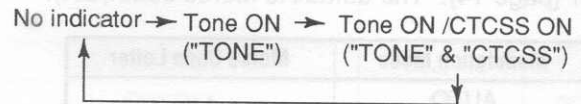

The CTCSS indicator does not appear if the CTCSS unit is not installed.



Note:

- ◆ When using DTSS or Page with CTCSS, the squelch opens only if the correct CTCSS tone is received and the received DTSS or Page code matches the code stored in your transceiver.
- ◆ If CTCSS and Tone Alert are ON, there is no speaker output except the alarm tone even if a signal is received with the correct CTCSS frequency.

9 DUAL TONE SQUELCH SYSTEM (DTSS)

DTSS provides a more refined method than CTCSS to selectively communicate with specific stations. A total of 1000 3-digit DTMF (Dual Tone Multi-Frequency) codes are available to be used as addresses for stations with which you want to communicate. These codes can be changed easily and regularly as required. Due to the quantity of different codes, large networks can be set up that use DTSS for selective calling and receiving. By including group codes in the network plan, sub-groups within the network can be contacted without disturbing others monitoring the same frequency.

If your needs are simpler, DTSS also serves a useful purpose when you only want direct communication with a few close friends on your favorite frequency. A good example of this application is at Hamventions when a particular frequency can be virtually unusable due to overcrowding. If your group switches ON DTSS, your squelch only opens when a call is received encoded with the same code that is stored in your transceiver. If no signal is received for more than 2 seconds after DTSS has opened the squelch, the squelch then closes. Anytime you want to monitor all activity on the channel, you simply switch OFF DTSS.

DTSS can only be activated when using FM mode.

STORING DTSS CODES

You can store a DTSS code from 000 to 999 by using the **Tuning** control or the microphone. If DTMF audio from other equipment is picked up by your microphone while you are entering digits, digits corresponding to the interfering DTMF audio may be entered instead of the digits entered on your keypad.

- 1 Press **[F]**, **[REV]** to activate Code Select.
- 2 Turn the **Alternate Tuning** control to select Menu No. 00.
 - The Code Select display appears with the first digit of the currently selected code blinking.



- 3 Select the first digit for the DTSS code using the following buttons:
 - **[F.LOCK]** or microphone **[UP]** → Increments digit
 - **[LOW]** or microphone **[DWN]** → Decrements digit
 - Alternatively, if your microphone is equipped with a DTMF keypad, you can enter the DTSS code by using the keypad numeric keys. Press the numeric key for the first digit of the code you want. Jump to Step 5.

- 4 Press **[SHIFT]**.
 - The next digit in the code starts blinking.
 - This step is not necessary if you are using the DTMF keypad.



- 5 Repeat Steps 3 and 4 for the second and third digits in the code.
- 6 Press **[CLR]** or **[PTT]**.
 - The previous mode is restored.

ENABLING DTSS

To switch ON DTSS, press **[F]**, **[SHIFT]**.

- "DTSS" appears when DTSS is ON.
- Each press of **[F]**, **[SHIFT]** switches the transceiver as follows:

No indicator → DTSS ON → PAGE ON
("DTSS") ("PN")



Note:

- Both DTSS status and a DTSS code can be stored in a memory channel; however, only a DTSS status can be stored in the Call channel. Further, when recalling either a memory channel or the Call channel with DTSS status ON while using the VFO with Page switched ON, Page is given priority.
- The microphone is inhibited while the DTSS code is transmitted.
- If DTSS and Tone Alert are ON, there is no speaker output except the alarm tone even if a signal is received with the correct DTSS code.

DTSS AND REPEATERS

Pressing **[PTT]** transmits the DTSS signal after a short delay. This delay helps avoid losing DTSS data when using repeaters with long response times that may miss receiving a portion of the DTSS code.

The delay time is 250 ms during simplex operation.

When using a transmit offset or a split frequency, you can change 350 ms (default) to 550 ms via Menu B, No. 65 {page 14}.

Note: When a repeater ID and a DTSS code are transmitted at the same time, DTSS may not function.

OVERVIEW

Similar to DTSS, Page uses DTMF codes to address a single station or a group of stations. Page is useful when waiting to receive a call from a specific station. A common Group Page code and individual Station codes should be agreed on in advance. You can select codes from the range 000 to 999 inclusive.

Unlike DTSS, Page offers the added benefit of identifying who called you. The calling station's code appears on the target transceiver's display. If called with an individual Station code, that station's code appears; if called with a Group code, the Group code appears. This characteristic of Page helps reduce the activity level on a frequency when operators are temporarily absent from their stations. There is no longer a need for repeated calls when your target station is not listening. On return to his or her operating position, their transceiver display will show your Station code. They will know immediately that you called.

Page can only be activated when using FM mode.

PAGE CODE MEMORY

The transceiver has 10 Page memories in total. The chart below lists all Page memories and the function they serve.

Page Menu Number	Page Memory	Function
01	A	Stores your Station code.
02	0	Holds a calling station's code. The transceiver automatically stores this code after receiving a code from another station. You can use the stored code also to respond to the other station.
03-10	1-8	Stores Group codes or Station codes that you want to call.
11	--	Allows you to scroll through all Page codes that you have stored. The last Page code viewed in this menu becomes the current code after exiting from the menu.

STORING PAGE CODES

To save the desired Page codes, use the following procedure. If DTMF audio from other equipment is picked up by your microphone while you are entering digits, digits corresponding to the interfering DTMF audio may be entered instead of the digits entered on your keypad.

- 1 Press **[F]**, **[REV]** to activate Code Select.
- 2 Turn the **Alternate Tuning** control to select Menu No. 01.
 - "P NNN" appears where "NNN" is the 3-digit code stored in Page memory A. The first digit of the code is blinking. "P---" indicates no codes have been stored previously.

Page Menu Number Page Memory

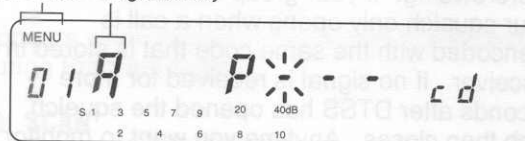

- 3 Select the first digit for your Station code using the following buttons:
 - **[F.LOCK]** or microphone **[UP]** → Increments digit
 - **[LOW]** or microphone **[DWN]** → Decrements digit
 - Alternatively, if your microphone is equipped with a DTMF keypad, you can enter your Station code by using the keypad numeric keys. Press the numeric key for the first digit of the code you want. Jump to Step 5.
- 4 Press **[SHIFT]**.
 - The next digit in the code starts blinking.
 - This step is not necessary if you are using the DTMF keypad.

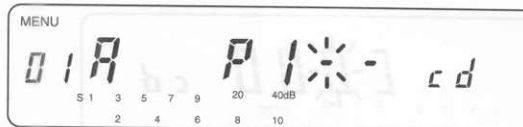

- 5 Repeat Steps 3 and 4 for the second and third digits in the code.
- 6 To store additional Group or Station codes, repeat Steps 2 to 5.
- 7 Press **[CLR]** or **[PTT]**.
 - The previous mode is restored.

CALLING

- 1 Tune to the prearranged frequency.
- 2 Press **[F]**, **[SHIFT]** twice.
 - "PN" appears. "N" is the Page memory number (0 - 8, A) of the currently selected Page memory.
 - If the DTSS function was ON, you only need to press **[F]**, **[SHIFT]** one time. This turns DTSS OFF and Page ON.



- 3 Press **[F]**, **[REV]** to activate Code Select.
- 4 Turn the **Alternate Tuning** control to select Menu No. 11.
- 5 Select the desired Page memory using the following buttons:
 - **[F.LOCK]** or microphone **[UP]** → Increments digit
 - **[LOW]** or microphone **[DWN]** → Decrements digit
 - Alternatively, if your microphone is equipped with a DTMF keypad, you can enter the Page memory number by using the keypad numeric keys or the **[A]** key.

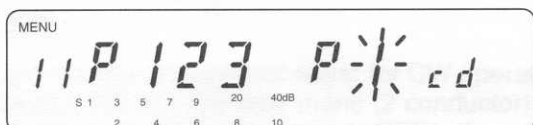

- 6 Press **[CLR]** or **[PTT]**.
 - The previous mode is restored.
- 7 Press and hold **[PTT]**.
 - The Group code or target Station code and your Station code are transmitted.



Note:

- ◆ When Page is ON, Scan cannot be used.
- ◆ When Page is ON, selecting VFO A/B, a memory channel, or the Call channel does not affect the Page status provided FM mode is selected. Page remains ON. However, if SSB or CW is selected, Page turns OFF automatically.

RECEIVING

- 1 Tune to the prearranged frequency.
- 2 Press **[F]**, **[SHIFT]** twice.
 - If the DTSS function was ON, you only need to press **[F]**, **[SHIFT]** one time. This turns DTSS OFF and Page ON.
 - Page can only be activated when using FM mode.

You are ready to receive a call addressed with your Station code or a Group code. If no signal is received for more than 2 seconds after a Page has opened the squelch, the squelch then closes.

RECEIVING A CALL WITH YOUR STATION CODE

When a signal is received encoded with your Station code, the squelch opens and you hear an alert tone from the speaker. In addition, "P0" and the calling station's code appear.



Press **[PTT]** while "P" is blinking to respond to the calling party.

RECEIVING A CALL WITH A GROUP CODE

When a signal is received encoded with the correct Group code, the squelch opens and you hear an alert tone from the speaker. In addition, the received Group code and the Page memory (1 to 8) in which that Group code has been stored appear.



Press **[PTT]** while "P" is blinking to respond to the calling party.

Note:

- ◆ "Err" appears on the Display if your transceiver fails to receive the Page code correctly.
- ◆ The microphone is inhibited while the Page code is transmitted.
- ◆ If Page and Tone Alert are ON, there is no speaker output except the alarm tone even if a signal is received with the correct Page code.

PAGE CODE AND REPEATERS

Pressing [PTT] transmits the Page code after a short delay. This delay helps avoid losing Page data when using repeaters with long response times that may miss receiving a portion of the Page code.

The delay time is 250 ms during simplex operation.

When using a transmit offset or a split frequency, you can change 350 ms (default) to 550 ms via Menu B, No. 65 (page 14).

Note: When a repeater ID and a Page code are transmitted at the same time, Page may not function.

LOCKING-OUT CODES

This function is useful if you wish to inhibit the transceiver from receiving specific Group Page codes. Page Lock-out does not inhibit the transceiver from receiving stations calling your individual Station code. Although the codes are locked-out from the receiver, the transmitter still transmits a Page on the locked-out channels.

Lock-out Page codes with the following procedure.

- 1 Press [F], [REV] to activate Code Select.
- 2 Turn the Alternate Tuning control to select the Page memory that contains the Page code that you want to lock-out.
- 3 Press [MR].
 - A "star" appears above the Menu No. indicating the Page code is locked-out.
- 4 Press [CLR] or [PTT].
 - The previous mode is restored.

Note: You cannot lock-out Page memory 0 or A.

AUTO PAGE CANCEL

After successfully paging another station, it is useful to turn OFF Page to eliminate sending a Page code each time you transmit. Auto Page Cancel handles this situation automatically when a station you called responds using the correct Page code to open your transceiver's squelch. On your next transmission, your transceiver then switches OFF your transceiver's Page function.

Turn this function ON or OFF via Menu B, No. 63 (page 14). The default is OFF.

OPEN PAGE

When both this function and Page are ON, any signal opens the squelch; however, if a correct Page code is received, the calling station's code appears on the Display. This feature is beneficial when you want to generally monitor activity on a frequency but you want to be especially sure not to miss a friend's call.

Turn this function ON or OFF via Menu B, No. 64 (page 14). The default is OFF.

11 TONE ALERT

Tone Alert provides an audible alarm to indicate when someone is transmitting on the frequency you are monitoring.

Tone Alert is an effective partner with CTCSS, Page, or DTSS. When the correct signaling comes through, your transceiver alerts you of an incoming call from a specific station. If using any of these functions with Tone Alert, the CTCSS/Tone frequency and the DTSS/Page code must match those programmed in your transceiver or else Tone Alert is not activated.

Tone Alert can only be used with FM mode.

ENABLING TONE ALERT

- 1 Tune to the prearranged frequency.
- 2 Activate CTCSS, Page, or DTSS if you want to use these together with Tone Alert.
- 3 Press **[F]**, **[TONE]**.
 - A "bell" icon appears.
 - Each time this key combination is pressed, Tone Alert toggles ON and OFF.



- 4 When the correct signal is received, you hear 5 double beeps, the "bell" icon starts blinking, and the Call Number increments.
 - The Display shows the number of minutes and seconds elapsed after the last signal was received. After 59 minutes 59 seconds pass, the Display changes to 01.00 and continues counting. After 59 hours 59 minutes pass, counting stops. When the next signal is received, the time resets to 00.00 and counting continues. Each time a new signal is received, the time resets to 00.00.
 - The Call Number records the number of calls received to a maximum of 99.



- 5 Exit Tone Alert by pressing **[PTT]**.

Note:

- ◆ APO turns OFF the power if no key entry is made for 180 minutes even if Tone Alert is ON.
- ◆ If Tone Alert is ON, there is no speaker output except the alarm tone when a signal is received. To hear activity on the frequency without disabling Tone Alert, program one of the microphone PF keys or Front Panel **[PF]** for the Monitor function (page 35).
- ◆ For Tone Alert to function correctly with CTCSS, the incoming signal must be present for approximately 1 second.
- ◆ If you find Tone Alert does not work reliably, your receive signal may contain distortion or a high level of ignition noise. One remedy is to install a TSU-8 CTCSS unit and select a Tone of 141.3 Hz or lower to act as a filter.

12 MAINTENANCE

GENERAL INFORMATION

Your transceiver has been factory aligned and tested to specification before shipment. Under normal circumstances, the transceiver will operate in accordance with these operating instructions. All adjustable trimmers, coils and resistors in the transceiver were preset at the factory. They should only be readjusted by a qualified technician who is familiar with this transceiver and has the necessary test equipment. Attempting service or alignment without factory authorization can void the transceiver warranty.

When operated properly, the transceiver will provide years of service and enjoyment without requiring further realignment. The information in this section gives some general service procedures requiring little or no test equipment.

SERVICE

If it is ever necessary to return the equipment to your dealer or service center for repair, pack the transceiver in its original box and packing material. Include a full description of the problems experienced. Include your telephone number along with your name and address in case the service technician needs to call for further explanation while investigating your problem. Don't return accessory items unless you feel they are directly related to the service problem.

You may return your transceiver for service to the authorized KENWOOD Dealer from whom you purchased it or any authorized KENWOOD Service Center. A copy of the service report will be returned with the transceiver. Please do not send subassemblies or printed circuit boards. Send the complete transceiver.

Tag all returned items with your name and call sign for identification. Please mention the model and serial number of the transceiver in any communication regarding the problem.

SERVICE NOTE

Dear YL/OM,

If you desire to correspond on a technical or operational problem, please make your note short, complete, and to the point. Help us help you by providing the following:

- 1 Model and serial number of equipment
- 2 Question or problem you are having
- 3 Other equipment in your station pertaining to the problem
- 4 Meter readings
- 5 Other related information

CAUTION: Do not pack the equipment in crushed newspapers for shipment! Extensive damage may result during rough handling or shipping.

Note:

- ◆ Record the date of purchase, serial number and dealer from whom the transceiver was purchased.
- ◆ For your own information, retain a written record of any maintenance performed on the transceiver.
- ◆ When claiming warranty service, please include a photocopy of the bill of sale, or other proof-of-purchase showing the date of sale.

CLEANING

The keys, controls and case of the transceiver are likely to become soiled after extended use. Remove the controls from the transceiver and clean them with a neutral detergent and warm water. Use a neutral detergent (no strong chemicals) and a damp cloth to clean the case.

INTERNAL ADJUSTMENTS

REMOVING THE CASE

CAUTION: Always turn OFF the power and unplug the DC power cable first.

Remove the 9 screws from the case. Lift off the 2 sections of the case.

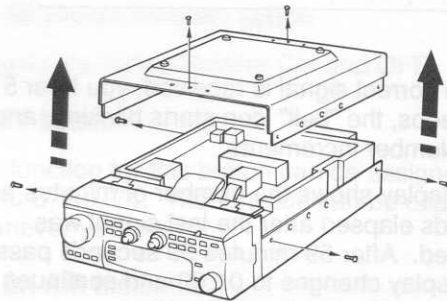

USING THE SQC PIN FOR RELAY OUTPUT

The function of the SQC pin located in the DATA connector {page 6} can be changed to function as a relay output.

- 1 Remove the lower case section {page 46}.
- 2 Move the slide switch located on the bottom rear of the transceiver to the "RL" position.

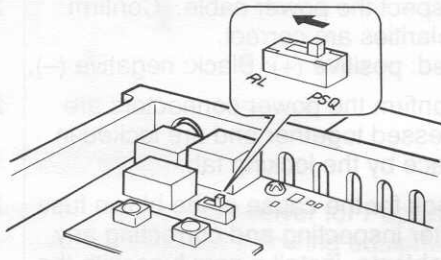

In future, if you decide to use the Squelch Control function, repeat this procedure but select the PSQ position with the switch.

Problem Symptom	Possible Cause
The transceiver will not power up after connecting a 13.8 V DC power supply and pressing [POWER], nothing appears on the Display.	1 The DC power supply is not switched ON. 2 The power cable is faulty. 3 The power cable is not connected securely. 4 The power cable fuse is open.
After switching the power ON, the transceiver does not function normally.	1 The output voltage is outside 13.8 V DC ±5% (11.7 to 15.8 V DC). 2 The microprocessor has malfunctioned.
The Display is too dim.	1 The Display Brightness needs changing. 2 The Automatic Power Off (APO) function has timed out. 3 The supply voltage is too low.
No sound comes from the speaker even though the VOL control is turned clockwise.	1 The squelch is closed. 2 DTS is ON ("DTS" is visible); DTS codes that you are receiving are different from the code set in your transceiver. 3 Page is ON ("P" is visible); Page codes that you are receiving are different from those set in your transceiver. 4 If the CTCSS option is installed; CTCSS is ON ("CTCSS" is visible); CTCSS tones that you are receiving are different from the CTCSS tone frequency set in your transceiver. 5 Tone Alert is ON ("Bell" icon is visible).
Buttons and the Tuning control do not function.	1 The Lock function is ON. 2 Microphone Lock is ON. 3 One or more of the Menu Lock functions are ON.

Continued

13 TROUBLESHOOTING

The problems described in this table are commonly encountered operational malfunctions. These types of difficulties are usually caused by improper hook-up, accidental incorrect control settings, or operator error due to incomplete programming, and are not caused by a circuit failure. Please review this table, and the appropriate section(s) of this Instruction Manual, before assuming your transceiver is defective.

Problem Symptom	Probable Cause	Corrective Action	Page Ref.
The transceiver will not power up after connecting a 13.8 V DC power supply and pressing [POWER] . Nothing appears on the Display.	1 The DC power supply is not switched ON.	1 Switch the DC power supply ON.	3
	2 The power cable is faulty.	2 Inspect the power cable. Confirm polarities are correct. Red: positive (+); Black: negative (-).	2, 3
	3 The power cable is not connected securely.	3 Confirm the power connectors are pressed together and are locked in place by the locking tab.	2, 3
	4 The power cable fuse is open.	4 Look for the cause of the blown fuse. After inspecting and correcting any problems, install a new fuse with the same rating.	2, 3
	5 The cable connecting the Front Panel and the Main Unit is disconnected.	5 Connect the cable.	4
After switching the power ON, the transceiver does not function normally.	1 The input voltage is outside 13.8 V DC $\pm 15\%$ (11.7 to 15.8 V DC).	1 Correct the input voltage.	2, 3
	2 The microprocessor has malfunctioned.	2 Do a Full Reset by pressing [MR]+ POWER ON .	34
The Display is too dim.	1 The Display Brightness needs changing.	1 Change the Display Brightness via Menu A, No. 00.	13, 39
	2 The Automatic Power OFF (APO) function has timed out.	2 Press [POWER] twice.	37
	3 The supply voltage is too low.	3 The supply voltage requirement is 13.8 V DC $\pm 15\%$ (11.7 to 15.8 V DC). If the input voltage is outside this range, adjust your regulated power supply or recharge your battery.	2, 3
No sound comes from the speaker even though the VOL control is turned clockwise.	1 The squelch is closed.	1 Reset the squelch threshold.	16
	2 DTSS is ON ("DTSS" is visible); DTSS codes that you are receiving are different from the code set in your transceiver.	2 To monitor activity, press the key combination [F] , [SHIFT] twice to turn OFF DTSS. To contact stations using DTSS, review the "DTSS" section.	41
	3 Page is ON ("P" is visible); Page codes that you are receiving are different from those set in your transceiver.	3 To monitor activity, press [F] , [SHIFT] to turn OFF Page. To contact stations using Page, review the "Page" section.	42
	4 If the CTCSS option is installed, CTCSS is ON ("CTCSS" is visible); CTCSS tones that you are receiving are different from the CTCSS tone frequency set in your transceiver.	4 To monitor activity, press [TONE] to turn OFF CTCSS. To contact stations, review the "CTCSS" section.	40
	5 Tone Alert is ON ("Bell" icon is visible).	5 Press [F] , [TONE] to turn OFF Tone Alert.	45
Buttons/keys and the Tuning control do not function.	1 The Lock function is ON.	1 Press [F.LOCK] to turn Lock OFF.	36
	2 Microphone Lock is ON.	2 Slide the Lock switch on the rear of the microphone to unlock the microphone.	37
	3 One or more of the Menu Lock functions are ON.	3 Check the status of Menu B, Nos. 68 and 69.	37

Continued

Problem Symptom	Probable Cause	Corrective Action	Page Ref.
Turning the Main Tuning control does not change the frequency.	Memory Recall or the Call channel is selected.	Press [A/B] or microphone [VFO] .	17
Turning the Alternate Tuning control, or pressing microphone [UP]/[DWN] , when in Memory Recall does not select memory channels.	No data has been saved in any memory channels.	Store data in some memory channels.	24
The Call channel cannot be selected by turning the Alternate Tuning control when attempting to program new Call channel data.	Memory Recall is selected instead of Memory Scroll.	Press [M.IN] to select Memory Scroll ("M.SCR" appears). Press [CLR] to restore the previous mode.	26
Previously stored data is gone when the transceiver is powered.	The backup lithium battery voltage is too low.	Obtain a new battery from your dealer or a KENWOOD Service Center.	24
Tone, CTCSS, DTSS, or Page cannot be activated.	FM mode is not selected.	Press [AUTO/FM] to select FM.	19
You cannot access and use repeaters.	1 The repeater requires a Tone frequency for access.	1 Review "TONE ACCESS" and select the correct Tone.	20
	2 The repeater requires a Transmit Offset to be used.	2 Review "TRANSMIT OFFSETS" and select the correct offset.	19
	3 Your antenna is not pointed accurately in the direction of the repeater.	3 Re-orient your antenna so it is beaming toward the repeater.	—
	4 Your transmit power is too low.	4 Press [LOW] to select High transmit power.	18
You cannot transmit even though you press [PTT] .	1 The microphone plug is not inserted completely in the Front Panel connector.	1 Turn OFF the power, ensure the microphone connector on the Front Panel has no foreign objects in it, then insert the microphone plug until the locking tab clicks in place.	4
	2 You have selected a transmit offset that places the transmit frequency outside the transmit band.	2 Press [SHIFT] one or two times so neither "+" nor "-" are visible.	19
	3 You have selected CW mode instead of a voice mode.	3 Press [AUTO/FM] or [SSB/CW] to select a voice mode.	19, 23
Attempting to transmit results in the "HELLO" message appearing and the Receive mode being restored.	1 The antenna is not connected correctly.	1 Check the antenna connection. Correct as necessary.	2, 4
	2 The antenna is not matched correctly with the transceiver.	2 Improve the match between the antenna and the transceiver.	2, 4
	3 The input voltage is outside 13.8 V DC $\pm 15\%$ (11.7 to 15.8 V DC).	3 Correct the input voltage.	2, 3
	4 An inappropriate DC power cable is being used.	4 Use the provided or optional DC power cable.	2, 3
SSB/CW receive sensitivity seems poor.	The Advanced Intercept Point function is ON.	Press [AIP] to turn OFF the AIP function.	33
Received signals are totally unintelligible.	The wrong modulation mode is selected.	Press [AUTO/FM] or [SSB/CW] to select the correct modulation mode.	19, 23

Continued

13 TROUBLESHOOTING

Problem Symptom	Probable Cause	Corrective Action	Page Ref.
Turning the RIT control has no effect on the receive frequency.	The Receive Incremental Tuning function is turned OFF.	Press [RIT] to turn ON the function.	33
SSB audio quality is very poor; the high or low audio frequencies are absent.	The IF SHIFT control is set incorrectly.	Return the IF SHIFT control to the center detent position.	33
The frequency display is showing frequencies far outside the range of the transceiver.	The Transverter Frequency Display function is ON.	Turn OFF Menu B, No. 76.	37
Scan doesn't work.	Squelch is not set correctly.	Adjust the SQL control to just eliminate background noise.	16
Program Scan doesn't stop when signals are received.	The Busy-Frequency Stop function is OFF.	Turn ON Menu A, No. 03.	29
Band Scan only scans a narrow range of frequencies; the entire band cannot be scanned.	You are actually using Basic Scan because you have selected a VFO frequency within the limits for Basic Scan and you have set the Basic Scan Limits in memory channel 99.	Select a frequency that is outside the limits set for Basic Scan, then press [SCAN] . Or, you could erase the frequency limits stored in memory channel 99 by selecting that channel and pressing [CLR] (2 s) .	31
Scan Hold doesn't work even though Menu B, No. 56 is ON.	Busy-frequency Stop has not been turned OFF.	Turn OFF Menu A, No. 3.	29
Memory Scan doesn't work.	1 Data is not stored in 2 or more memory channels.	1 Store frequency data in at least 2 memory channels.	24, 25
	2 All memory channels are locked out.	2 Unlock the memory channels you want to scan.	30
	3 With Group Scan selected, the channel you want to scan is in a different group.	3 Select All-channel Scan, or program the desired frequency within the current group.	30, 24
The transceiver switches OFF for no apparent reason.	1 The Automatic Power Off function is ON.	1 Turn OFF the APO function via Menu B, No. 58.	37
	2 No key entry was made for 180 minutes when both APO and Tone Alert were ON.	2 Switch the power ON again.	37, 16
The transceiver does not respond correctly after you press button combinations per instructions in this manual.	1 Buttons are not being pressed in the correct manner.	1 Review "CONVENTIONS FOLLOWED IN THIS MANUAL". Different functions are selected depending on how long a button is held down or whether a button is released before the next button is pressed, etc.	ii
	2 The microprocessor and its memory need resetting.	2 First review "MICROPROCESSOR RESET". After understanding what data will be lost, do a Partial Reset. If the problem remains, do a Full Reset.	34

Continued

Problem Symptom	Probable Cause	Corrective Action	Page Ref.
<p>Packet operation results in no connects with other stations.</p>	<p>1 Physical connections between the transceiver, computer, and TNC are incorrect, or software settings in the TNC are wrong.</p>	<p>1 Re-check all connections using this manual, your TNC manual and your computer hardware manual as references.</p>	<p>5</p>
	<p>2 Different transmit and receive frequencies are being used. You must use the same transmit and receive frequency for packet.</p>	<p>2 Store the desired operating frequency in a memory channel using the "Simplex Channel Storage" procedure.</p>	<p>24</p>
	<p>3 The modulation level from the TNC is incorrect.</p>	<p>3 Adjust the TNC modulation level per instructions in "PACKET OPERATION" and your TNC manual.</p>	<p>22</p>
	<p>4 The 9600 bps rate setting is set incorrectly.</p>	<p>4 Refer to "PACKET OPERATION" for information on setting Menu B, No. 77 correctly.</p>	<p>22</p>
	<p>5 The transmitted signal is too weak.</p>	<p>5 Reorient your antenna or increase your antenna gain to improve your signal strength at the other station.</p>	<p>–</p>
	<p>6 Tone, CTCSS, DTSS, or Page are ON.</p>	<p>6 Turn OFF Tone, CTCSS, DTSS, and Page. Set the noise squelch threshold as you would for voice communications.</p>	<p>20, 40, 41, 43, 16</p>

14 OPTIONAL ACCESSORIES

MC-45/45E
Multifunction Microphone



MC-45DM/45DME
Multifunction Microphone
with DTMF keys



PS-33
Regulated DC Power
Supply



PS-53
Regulated DC Power
Supply

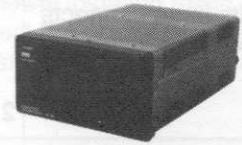

PG-2N
DC Power Cable



PG-3G
DC Line Noise Filter



MB-13
Mobile Mounting Bracket



TSU-8
CTCSS Unit



VS-2
Voice Synthesis Unit

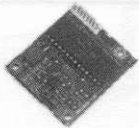

PG-5A
Data Cable



DFK-3
Detachable Front Panel
Kit (3 m)



DFK-4
Detachable Front Panel
Kit (4 m)

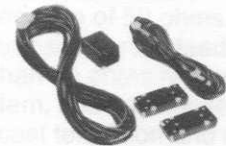

DFK-7A
Detachable Front Panel
Kit (7 m)



MC-60A
Unidirectional Dynamic
Desk Microphone



MC-80
Unidirectional Electret
Condenser Desk
Microphone



MC-85
Unidirectional Electret
Condenser Desk
Microphone



MJ-88
Microphone Plug
Adaptor¹



SP-41
Mobile Speaker



SP-50B
Communications Speaker



¹ MJ-88 is required to use MC-60A, MC-80, or MC-85.

15 INSTALLING OPTIONS

DETACHABLE FRONT PANEL KITS (DFK-3, DFK-4, DFK-7A)

INSTALLATION

CAUTION: Always turn OFF the power and unplug the DC power cable first.

1 Remove the Front Panel.

Press the Release button on the left side of the Front Panel to unlock the panel. Carefully pull the Front Panel forward from the left, then remove it completely.

- Handle the Front Panel carefully to avoid applying excessive force to the thin cable joining the Front Panel to the Main Unit.

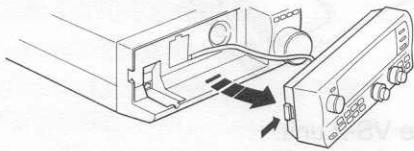

2 Remove the covers.

Remove Cover A from the Main Unit, and Cover B from the Front Panel.

- To remove the covers, insert a flat-blade screwdriver into the gap, and pry the cover off using the minimum force necessary.

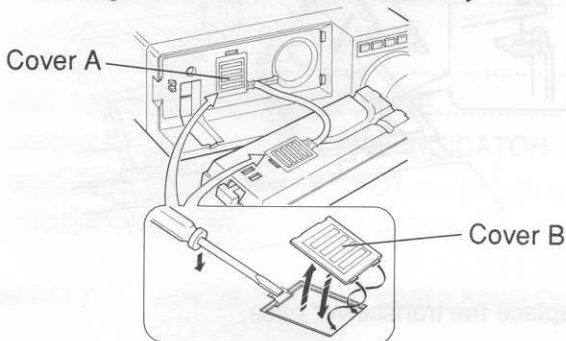

3 Replace the interconnecting cable.

Remove the 2 connectors, then replace the cable with the optional cable. Reinstall Cover A on the Main Unit and Cover B on the Front Panel by positioning the cover's tab, then press the cover into position.

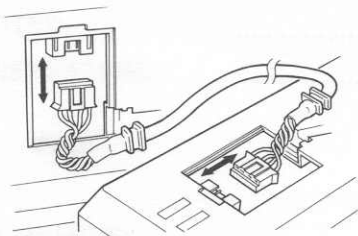

4 Connect the microphone cable (DFK-4/DFK-7A only).

Plug the microphone cable plug into the microphone connector on the Main Unit. Press the plug firmly into the connector until the locking tab clicks into place.

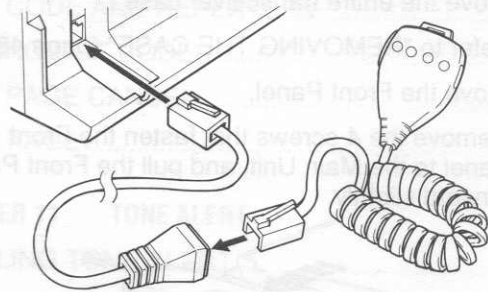

5 Reinstall the Front Panel.

■ Installation Example

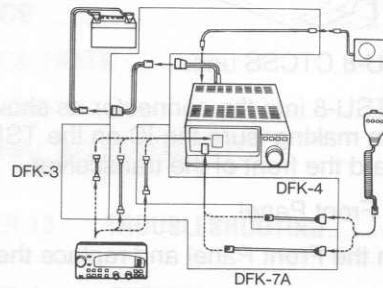

OPERATION

After separating the Front Panel from the Main Unit, the **Main Tuning** control will not be accessible if the Main Unit is stored in a location that is removed from the operating position. Therefore, if using SSB or CW, it is necessary to change the frequency step of the **Alternate Tuning** control.

The frequency step for SSB and CW is changed via Menu A, No. 06. If you assign this function to the microphone PF key, it will be easy to modify the step size at any time. With this function assigned to the microphone PF key, it is quite quick to select a large frequency step, then change frequency by hundreds of kHz with the **Alternate Tuning** control. Then reduce the step size, and fine tune with the new smaller step size selected.

Lock the **Main Tuning** control via Menu B, No. 68. Also, lock the buttons controlled via Menu B, No. 69.

Note:

- ◆ Refer to the Detachable Front Panel Kit manuals for additional information.
- ◆ The DFK-7 kit cannot be used with this transceiver. Use the DFK-7A kit instead.
- ◆ Use only the supplied cables; do not use substitutions.

15 INSTALLING OPTIONS

TSU-8 CTCSS UNIT

CAUTION: Always turn OFF the power and unplug the DC power plug first.

- 1 Remove the entire transceiver case .
 - Refer to "REMOVING THE CASE" {page 46}.
- 2 Remove the Front Panel.
 - Remove the 4 screws that fasten the Front Panel to the Main Unit, and pull the Front Panel forward slightly.

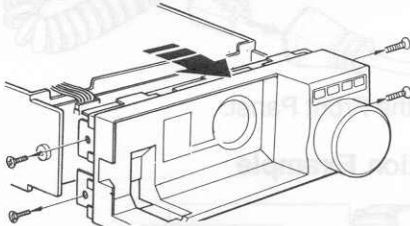

- 3 Install the TSU-8 CTCSS unit.
 - Insert the TSU-8 into the connector as shown in the diagram making sure the IC on the TSU-8 is facing toward the front of the transceiver.
- 4 Re-install the Front Panel.
 - Reposition the Front Panel and replace the 4 screws.
- 5 Re-install the transceiver case.
 - Replace the transceiver case and case screws.

VS-2 VOICE SYNTHESIS UNIT

CAUTION: Always turn OFF the power and unplug the DC power plug first.

- 1 Remove the transceiver case.
 - Refer to "REMOVING THE CASE" {page 46}.
- 2 Attach the connector.
 - Plug the connectorized cable from the Main Unit into the connector on the VS-2.

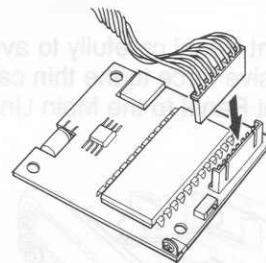

- 3 Attach the VS-2 unit.
 - Remove the backing from the cushion provided with the VS-2, and attach the cushion to the top of the IC on the VS-2. Remove the backing from the other side of the cushion.
 - Press the VS-2 onto the shield, and attach the protective cover over the VS-2 using a single screw as shown in the diagram.

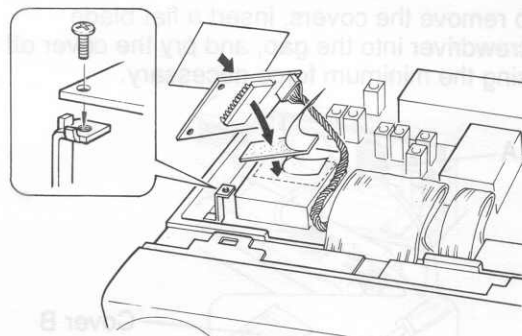

- 4 Replace the transceiver case.

SPECIFICATIONS

General

		TM-255A	TM-255E	TM-455A/455E
Frequency range		144 MHz ~ 148 MHz	144 MHz ~ 146 MHz	430 MHz ~ 440 MHz
Mode		J3E (LSB/USB), A1A (CW), F3E (FM)		J3E (LSB/USB), A1A (CW), F3E (FM)
Number of memory channels		100		100
Antenna impedance		50 Ω		50 Ω
Usable temperature range		-20°C ~ +60°C		-20°C ~ +60°C
Power supply		DC 13.8 V ±15%		DC 13.8 V ±15%
Grounding method		Negative ground		Negative ground
Current	Transmit (max.)	13.0 A or less		15.0 A or less
	Receive (no signal)	0.9 A or less		0.9 A or less
Frequency stability	-10°C ~ +50°C	—		Within ±1 x 10 ⁻⁶
	-20°C ~ +60°C	Within ±2.5 x 10 ⁻⁶		Within ±2 x 10 ⁻⁶
	-20°C ~ +60°C (FM transmit)	Within ±10 x 10 ⁻⁶		Within ±5 x 10 ⁻⁶
Dimensions (W x H x D) (projections included)		180 mm x 60 mm x 215.5 mm (180 mm x 68.5 mm x 250 mm)		180 mm x 60 mm x 215.5 mm (180 mm x 68.5 mm x 250 mm)
Weight		Approx. 2.7 kg		Approx. 2.8 kg

Transmitter

		TM-255A	TM-255E	TM-455A/455E
Power output	High	Approx. 40 W		Approx. 35 W
	Low	Approx. 5 W		Approx. 5 W
Modulation	SSB	Balanced		Balanced
	FM	Reactance		Reactance
Spurious emissions		-60 dB or less		-60 dB or less
Carrier suppression		40 dB or more		40 dB or more
Unwanted sideband suppression		40 dB or more		40 dB or more
Maximum frequency deviation (FM)		±5 kHz or less		±5 kHz or less
Transmit frequency characteristics (SSB)		400 Hz to 2600 Hz (Within -6 dB)		400 Hz to 2600 Hz (Within -6 dB)
Audio distortion (at 60 % modulation)		7% or less		7% or less
Microphone impedance		600 Ω		600 Ω

SPECIFICATIONS

Receiver

		TM-255A	TM-255E	TM-455A/455E
Circuitry	SSB/CW	Single conversion superheterodyne		Double conversion superheterodyne
	FM	Double conversion superheterodyne		Triple conversion superheterodyne
Intermediate frequency	1st	10.695 MHz		41.415 MHz
	2nd	455 kHz (FM only)		10.695 MHz
	3rd	—		455 kHz (FM only)
Sensitivity	SSB, CW (10 dB (S+N) / N)	0.13 μ V or less		0.11 μ V or less
	FM (12 dB SINAD)	0.20 μ V or less		0.18 μ V or less
Selectivity (-6 dB)	SSB, CW	2.1 kHz or more		2.1 kHz or more
	FM	12 kHz or more		12 kHz or more
Selectivity (-60 dB)	SSB, CW	4.8 kHz or less		4.8 kHz or less
	FM	28 kHz or less		28 kHz or less
Squelch sensitivity	SSB, CW	0.13 μ V or less		0.13 μ V or less
	FM	0.09 μ V or less		0.09 μ V or less
Audio output (8 ohms, 5% distortion)		2 W or more		2 W or more
Audio output impedance		8 Ω		8 Ω
RIT shift frequency range	10 Hz steps	\pm 1.1 kHz or more		\pm 1.1 kHz or more
	20 Hz steps	\pm 2.2 kHz or more		\pm 2.2 kHz or more

Microphone impedance	Audio distortion (at 50% modulation)	Transmit frequency characteristics (SSB)	Maximum frequency deviation	Unwanted sideband suppression	Carrier suppression	Spurious emission (AM/FM)	Modulation	Power output
800 Ω	Typical less	Typical less	100 Hz to 3000 Hz (within -3 dB)	\pm 5 kHz or less	40 dB or more	40 dB or more	FM	Approx. 8 W
800 Ω	Typical less	Typical less	100 Hz to 3000 Hz (within -3 dB)	\pm 5 kHz or less	40 dB or more	40 dB or more	SSB	Approx. 5 W
800 Ω	Typical less	Typical less	100 Hz to 3000 Hz (within -3 dB)	\pm 5 kHz or less	40 dB or more	40 dB or more	Balanced	Approx. 35 W

DETRATE (OFF)	18	BUSY FREQUENCY	28
POWER ON/OFF	16	SCAN RECALL METHOD	29
	15	SCAN HL	29
	14	MEMORY SCAN	30
	13	GROUP SCAN	30
	12	ALL CHANNEL SCAN	30
	11	PRIMARY CHANNEL LOCK-OUT	30
	10	PROGRAM SCAN	30
	9	REMOVING LOWER/UPPER FREQUENCY	31
	8		31
	7		31
	6		31
	5		31
	4		31
	3		31
	2		31
	1		31

GLOSSARY

Autopatch

A service available widely in the U.S.A. and Canada that allows portable or mobile stations to access the public telephone network by connecting through a local repeater. Telephone numbers are sent via DTMF signals by using the microphone DTMF keypad. Only non-commercial communication is authorized.

Automatic Level Control (ALC)

A circuit that automatically varies its gain to keep microphone audio input to the transceiver at a constant level.

Call channel

A frequency intended for establishing contact with other stations. A microphone key is dedicated to the Call channel so the frequency can be recalled quickly.

CTCSS (Continuous Tone Coded Squelch System)

Also referred to as Tone Squelch. A method of receiver squelch control that uses a subaudible tone superimposed by the transmitter on the transmitted signal. Only signals received with a subaudible tone that matches the tone selected at the receiver can open the receiver squelch.

CTCSS frequency

The subaudible frequencies used by CTCSS.

Default settings

The values selected for VFO frequency, Call channel frequency, Frequency Step, etc. by the transceiver after it is reset. All transceivers are shipped from the factory with default settings.

DTMF (Dual Tone Multi-Frequency) signal

A signal created by combining two discrete audio frequencies. Generally used for sending digits for repeater control or Autopatch applications.

DTSS (Dual Tone Squelch System)

A squelch control system that relies on a burst of data from the transmitter to open the receiver squelch. Only when the transmitted code matches the code programmed in the receiver will the squelch open.

Frequency step

The size of frequency change produced by turning a tuning control one position or pressing microphone [UP] or [DWN] one time while in VFO mode.

Group code

When using Page, a group will commonly agree on a single code that will be used for calls targeted for all members. This code is the Group code. See "Station code".

Hang Time

See Squelch Hang Time.

Keypad

The collection of keys on the microphone used to send DTMF tones.

Locked-out channel

An electronically marked memory channel that will be skipped during Memory Scan. This is a quick way to configure your Memory Scan without actually erasing data from memory channels that you may want to keep.

Memory channel

A "storage" location where you record an operating frequency and many other associated parameters for quick recall later. Normally, all commonly used frequencies including those of local repeaters would be saved in memory channels to eliminate manually selecting frequently-used frequencies.

Menu Setup

This is a newer term introduced with the creation of a Menu system for configuring transceiver features. Menu Set-up allows functions to be turned ON or OFF, or values to be set, through software rather than physical buttons or controls. Once you learn how to access the Menu, the standardized method of configuring features simplifies operation.

Microphone PF (Programmable Function) keys

Keys located on the microphone that can have transceiver functions assigned to them. Key assignments can be changed as necessary.

Non-standard offset

Refers to a transmit frequency offset used to access repeaters that is some value or direction other than that stipulated by existing band plans for a particular region. See "Transmit offset".

Packet

This transceiver is equipped with a connector on the Rear Panel designed specifically for Packet operation. Packet is a data communications mode used to exchange digital information that is typically created using a personal computer. In other words, Packet provides a method to link computers together via radio.

Page code memory

A memory channel dedicated to storing only Page codes. See "Page".

PTT (Push-to-talk)

Refers to the non-latching switch on the microphone that changes the transceiver from Receive to Transmit mode.

GLOSSARY

Repeater

A station, usually installed in a central location at a high elevation, designed to receive and re-transmit signals. The purpose of a repeater is to increase the receive and transmit range of stations able to access the repeater.

Reset (initialization)

The act of restarting the transceiver microcomputer. Depending on the type of reset done, some or all memory may be erased and set to default values. A reset can be done as a last resort when the transceiver appears to be malfunctioning.

Simplex channel

Refers to a communications channel where the receive and transmit frequencies are equal.

Split channel

Refers to a communications channel where the receive and transmit frequencies are not equal.

Squelch

A function that automatically mutes a receiver's speaker output when no receive signal is present.

Squelch Hang Time

The time that the squelch remains open after a carrier drops out.

Squelch threshold level

The receive level at which a receiver's speaker output is muted. This level is usually adjustable, either manually or automatically by the transceiver microcomputer.

Standard offset

Refers to a transmit frequency offset used to access repeaters that is equal to the amount and direction stipulated by existing band plans for a particular region. See "Transmit offset".

Station Page code

When using Page, each station must be assigned a unique code that no other station uses. This is your Station code. Only the squelch of the targeted station will open when a transmission with this Station code is made. See "Group code".

Subaudible Tone

A low-frequency signal superimposed by a transmitter on a transmitted signal for the purpose of accessing some types of repeaters.

SWR (standing wave ratio)

An antenna that is not correctly matched in impedance with a transmission line and transmitter will reflect some portion of the transmitted signal back toward the transmitter. This causes a standing wave pattern to develop. The ratio of maximum to minimum voltage (VSWR) on the transmission line when such a condition exists is commonly referred to as the SWR.

Tone frequency

See "Subaudible Tone".

Transmit offset (shift)

All Amateur voice repeaters operate on separate transmit and receive frequencies. Transmit offset is the amount that a transmit frequency is different from a receive frequency. See "Transmit offset direction".

Transmit offset (shift) direction

Refers to the direction, either plus (+) or minus (-), that a transmit frequency is with respect to a receive frequency. Both the direction and amount of offset must be selected correctly to access a repeater. See "Transmit offset".

VFO (variable frequency oscillator) mode

The mode that allows any individual frequency to be selected within the range of the VFO only restricted by frequency step limitations. When in VFO mode, frequencies are selected using the Tuning control or microphone [UP]/[DWN].

Models Covered by this Manual

TM-255A	144 MHz All Mode Transceiver (U.S.A./Canada)
TM-255E	144 MHz All Mode Transceiver (Europe)
TM-475A	430 MHz All Mode Transceiver (U.S.A./Canada)
TM-475E	430 MHz All Mode Transceiver (Europe)

Warnings to the user

Changes made to the working mechanism may be dangerous to the equipment.

Precautions

The equipment generates a very high frequency energy capable of causing burns in the equipment body. Do not touch the equipment body. The modifications are expressly approved in the instruction manual. The user bears the authority to operate the equipment only according to the change or modification it made.

INFORMATION TO THE DIGITAL DEVICE USER REQUIRED BY THE FCC

This equipment has been tested and found to comply with the Commission's interference requirements as detailed in Part 15 of the FCC Rules, provided that the following conditions are met: (1) This equipment must not be used near a digital modulation. (2) The equipment generates, transmits, reflects, radiates, emits, radiates, emits, and if not shielded, may cause harmful interference to radio communications. However, there is no guarantee that the interference will be stopped in a particular installation. (3) The equipment must be used only with a digital modulation receiver which has been approved by turning the equipment off and on, the user is encouraged to try to eliminate interference by one or more of the following measures:

- Reorient or separate the receiving antenna.
- Increase the distance between the equipment and receiver.
- Plug the equipment into a different power outlet.
- Consult the dealer or a qualified technician for assistance.

KENWOOD