

KENWOOD

144/220MHz FM DUAL BANDER

TM-631A

144/440MHz FM DUAL BANDER

TM-731A

144/430MHz FM DUAL BANDER

TM-731A

TM-731E

INSTRUCTION MANUAL

KENWOOD CORPORATION

©PRINTED IN JAPAN B50-8295-00(K, M, P, W)(T)
90/12 11 10 9 8 7 6 5 4 3 2 1 89/12 11 10 9 8 7 6 5 4

Thank you for purchasing this new transceiver.

IMPORTANT:

Please read this instruction manual carefully before placing your transceiver in service.

SAVE THIS INSTRUCTION MANUAL.

CAUTION:

Long transmission or extended operation in the HI power mode might cause the rear of this transceiver to get warm. Do not place the transceiver where the heat sink (rear panel) might come in contact with plastic or vinyl surfaces.

This Instruction Manual covers the following models.

- TM-631A : 144/220 MHz FM DUAL BANDER
- TM-731A : 144/440 MHz FM DUAL BANDER
(U.S.A. version)
- TM-731A : 144/430 MHz FM DUAL BANDER
(Other market)
- TM-731E : 144/430 MHz FM DUAL BANDER

The following explicit definitions apply in this manual:

- Note** : If disregarded, inconvenience only, no risk of equipment damage or personal injury.
- Caution** : Equipment damage may occur, but not personal injury.

CONTENTS

| | | |
|---|---|----|
| 1. BEFORE OPERATION | 3 | |
| 2. SPECIFICATIONS and ACCESSORIES | 5 | |
| 3. INSTALLATION INSTRUCTIONS | 6 | |
| 4. OPERATION | 9 | |
| OPERATING CONTROLS | | |
| RECEIVER OPERATION..... | | 15 |
| Reception | | |
| Frequency Selection..... | | 16 |
| Frequency Step Selection | | 17 |
| A.B.C. (Automatic Band Change) | | 18 |
| TRANSMITTER OPERATION | | 19 |
| REPEATER OPERATION | | |
| Transmitter Offsets | | |
| Reverse Function | | 20 |
| Tone Operation | | |
| Autopatch (U.S.A. version only)..... | | 22 |
| MEMORY..... | | 23 |
| Microprocessor Memory Back-up | | |
| Microprocessor Initialization | | |
| Memory Channel | | |
| Memory Contents | | |
| Memory Entry | | 24 |
| Simplex/Normal SHIFT | | |
| Odd Split Channels | | |
| Call Channel..... | | 26 |

| | |
|--------------------------------------|---------------|
| Memory Recall | |
| Memory Shift | |
| SCAN | 27 |
| Scan Options | |
| Hold Resume Programming | |
| Programmable Band Scan/Band Scan | |
| Memory Channel Scan..... | 28 |
| Double Scan | |
| Priority Alert | |
| Memory Channel Lockout..... | 29 |
| Tone Alert System | |
| 5. BLOCK DIAGRAM | |
| and SCHEMATIC DIAGRAM | another sheet |
| 6. MAINTENANCE | 30 |
| In Case of Difficulty | 31 |
| 7. OPTIONAL ACCESSORIES | 32 |
| CTCSS unit TSU-6 | |
| REMOTE CONTROLLER RC-10 | |
| ACCESSORIES | 35 |

1. **WARNING** BEFORE OPERATION

TO PREVENT ELECTRIC SHOCK, FIRE AND OTHER INJURY. PLEASE NOTE THE FOLLOWINGS:

To avoid risk of electric shock, under no circumstances should the unit be opened:

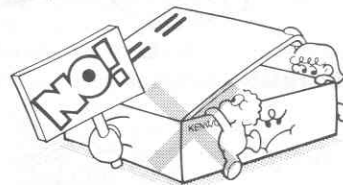

Do not place this unit, where it will be exposed to direct sunlight or close to heating appliances.

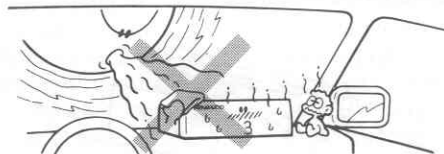

To ensure good ventilation, do not put anything on top of the cabinet and allow at least 15 cm (6 inches) of space behind the unit.

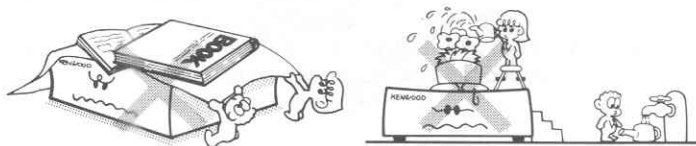

The power requirement is 13.8 VDC.
Never attempt connection to a 24 VDC source.

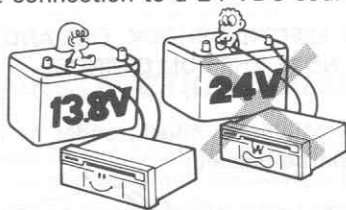

Do not place the unit in areas of excessive dust, high humidity or on unstable surfaces.

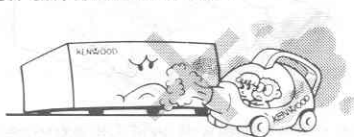

Do not drop pieces of metal, needles, coins and other electrically conductive materials into the unit.

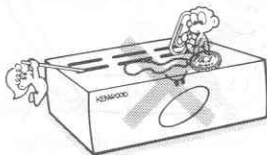

Do not touch the power plug, when your hands are wet.



Do not pull the power cord, when disconnecting it from the AC wall outlet. Grasp the plug and ensure that your fingers do not touch the live pins.



If an abnormal odor or smoke is detected, immediately turn the power off and pull out the power plug. Contact the KENWOOD service station or your dealer.



CLEANING

1. Turn the power off, before cleaning the unit.
2. Do not use any type of abrasive pad, thinner, benzine or any substances which may damage the unit.
3. Wipe the front panel and other exterior surfaces of the unit with a soft dry cloth or a soft cloth lightly moistened with water.

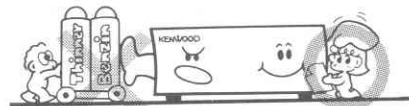

2. SPECIFICATIONS AND ACCESSORIES

2-1. SPECIFICATIONS

| Specifications | | Model | | TM-731E | TM-631A | |
|----------------------------|--|--------------------------------------|---|----------------------------------|----------------------------------|--|
| | | TM-731A | | | | |
| | | U.S.A. version | Other markets version | | | |
| General | Frequency range | 144 to 148 MHz 438 to 450 MHz | 144 to 148 MHz 430 to 440 MHz | 144 to 146 MHz 430 to 440 MHz | 144 to 148 MHz 220 to 225 MHz | |
| | Mode | F3E (FM) | | | | |
| | Antenna impedance | 50 ohms | | | | |
| | Power requirements | 13.8 VDC \pm 15% | | | | |
| | Ground | Negative | | | | |
| | Current drain | Transmit mode | Less than 11 A | | | |
| | | Receive mode with no signal | Less than 0.6 A | | | |
| | Operating temperature | -20°C to +60°C (-4°F to +140°F) | | | | |
| | Dimensions (W x H x D) (Projections included) | 150 x 50 x 219 mm (5.9" x 2" x 8.6") | | | | |
| | Weight | 1.8 kg (3.97 lbs) | | | | |
| Transmitter | Output power* | HI | 144 MHz: 50 W, 220 MHz: 25 W, 430/440 MHz: 35 W | | | |
| | | LOW | 5 W | | | |
| | Modulation | Reactance modulation | | | | |
| | Spurious radiation | Less than -60 dB | | | | |
| | Maximum frequency deviation | \pm 5 kHz | | | | |
| | Audio distortion (at 60% modulation) | Less than 3% (300 to 3000 Hz) | | | | |
| | Microphone impedance | 500 to 600 ohms | | | | |
| Receiver | Circuitry | | Double conversion superheterodyne | | | |
| | Intermediate frequency | U.S.A. version | 144 MHz: 16.9 MHz/455 kHz, 220 MHz: 30.825 MHz/455 kHz, 440 MHz: 21.6 MHz/455 kHz | | | |
| | | Other market | 144 MHz: 10.7 MHz/455 kHz, 430 MHz: 30.825MHz/455 kHz | | | |
| | Sensitivity(12 dB SINAD) | | 144 MHz: Less than 0.2 μ V, 220 MHz: Less than 0.18 μ V, 430/440 MHz: Less than 0.16 μ V | | | |
| | Selectivity | | -6 dB: More than 12 kHz, -60 dB: Less than 24 kHz | | | |
| | Spurious response | | Better than 60 dB | | | |
| | Squelch sensitivity | | Less than 0.09 μ V | | | |
| | Output | | More than 2 W across 8 ohms load (5% distortion) | | | |
| External speaker impedance | | 8 ohms | | | | |

Notes:

1. Circuit and ratings are subject to change without notice due to advancement in technology.
2. *Recommended duty cycle:
1 minute Transmission, 3 minutes Reception

2-2. ACCESSORIES

Unpack your new transceiver carefully, and confirm that the accessories listed below are included in the box.

- MC-44DM Microphone....T91-0380-15 1 ea.
(U.S.A. and CANADA)
or
MC-44E Microphone.....T91-0382-15 1 ea.
(U.K. and Europe)
or
MicrophoneT91-0379-15 1 ea.
(Other market)
Microphone Hook.....J20-0319-24..... 1 ea.
(U.S.A. and CANADA)
Self tapping Screw.....N46-3010-46 2 ea.
(U.S.A. and CANADA)
BracketJ29-0418-03..... 1 ea.
Mobile Mounting KitN99-0318-05 1 ea.
Wrench.....W01-0414-05 1 ea.
DC Power CableE30-2111-05 1 ea.
Fuse (15A).....F05-1531-05..... 1 ea.
Instruction ManualB50-8295-XX .. 1 copy
Warranty Card..... 1 ea.
(U.S.A., CANADA, and Europe)

After unpacking

Shipping container:

Save the boxes and packing in the event your unit needs to be transported for remote operation, maintenance, or service.

3. INSTALLATION INSTRUCTIONS

3-1. INSTALLATION

Mounting Bracket

When installing the transceiver in a vehicle consider the ease of operation and safety when selecting the location for the mounting bracket.

1. Install the bracket using the supplied flat washers and self tapping screws (4 pcs. each).
2. Attach the transceiver loosely using the SEMS screws (4 pcs.).
3. The angle of the bracket may be adjusted to any of 9 possible viewing angles. Select the desired angle. (Fig. 2)
4. Hold the transceiver in place and tighten the 4 SEMS screws using a wrench or screwdriver.

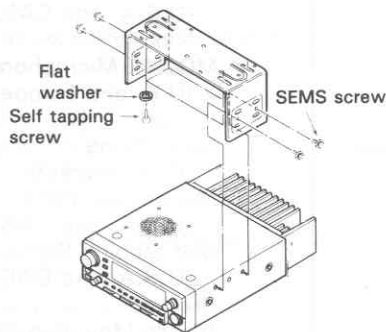
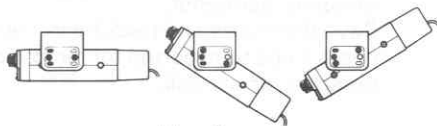

Fig. 1



3-2. CONNECTIONS

3-2-1. Mobile Installations

TM-731A/731E:

The MA-700 dual band antenna is recommended.

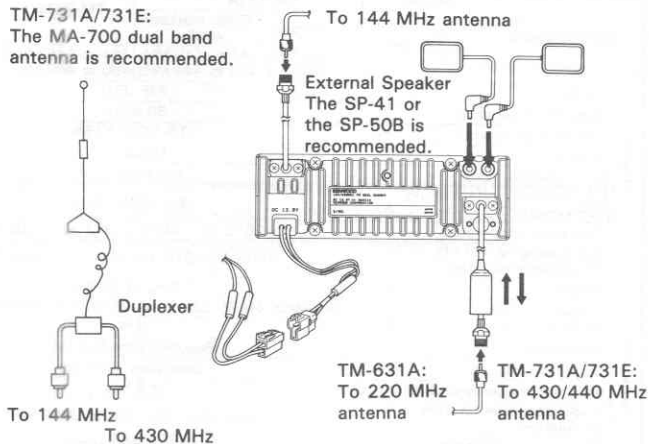

Cautions:

1. Before installing the power cable, be sure to remove the negative lead from the battery for safety.
2. After installation and wiring, be sure to double check for correct installation before reconnecting the negative lead to the battery terminal.
3. If the fuse opens, be sure to check that each conductor has not been damaged by short-circuiting, etc. Then replace with a new fuse of the same rating.
4. After completing the wiring, wrap the fuse holder with heat resistant tape to protect against heat and moisture.
5. Do not remove the fuse even if the power cable is too long.

A. Battery Connections

Connect the power cable directly to the battery terminals. Use of the cigarette lighter socket can lead to poor connection, and result in poor performance. Pay close attention to the polarity of the cables when connecting them to the battery.

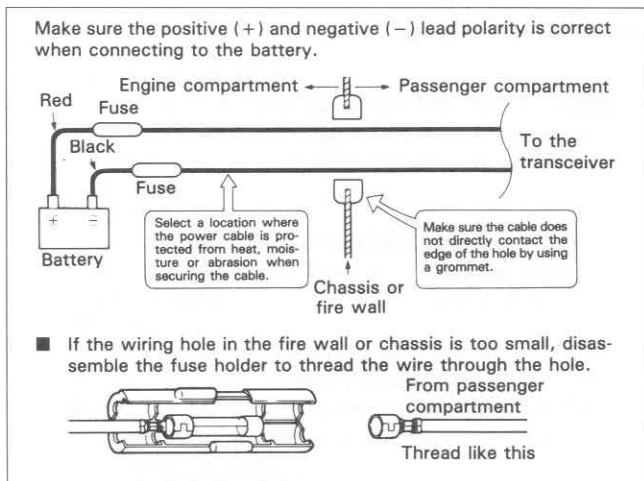

B. Ignition Noise

This transceiver has been designed to suppress ignition noise; however, if excessive noise is present, it may be necessary to use suppressor spark plugs (with resistors).

3-2-2. Fixed Station

A regulated DC power supply (13.8 VDC capable of supplying at least 10 Amperes) is required. The PS-430 and the PS-50 are recommended.

CAUTION:

1. Never connect the AC power cable to the AC outlet until all other connections have been made.
2. Before connecting and disconnecting the power connector, be sure to turn off the POWER switches of both the transceiver and the DC power supply.
3. Observe polarity of the DC power cable. The transceiver operates on 13.8 VDC, negative ground. Battery polarity must be correct. The power cable is color coded:
Red → + (Positive polarity)
Black → - (Negative polarity)

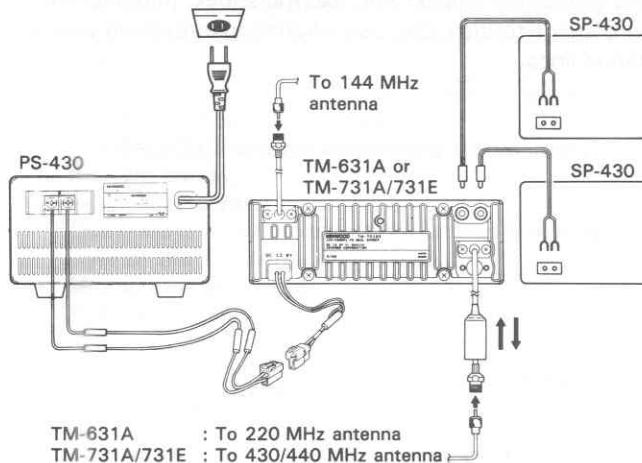

3-2-3. Antenna

The type of antenna that is used will greatly affect the performance of the transceiver. Use a properly adjusted antenna, of good quality, to enable your transceiver to perform at its best. The antenna input impedance is 50 ohms. Use 50-ohm coaxial cable such as RG-8U or 8D-2V for this connection. If the antenna is far from the transceiver the use of low loss coaxial cable, such as RG-8U is recommended. Match the impedance of the coaxial cable and that of the antenna so that the SWR is less than 1.5 to 1. The protection circuit in the transceiver will activate if the SWR is particularly poor (greater than 3 to 1).

High SWR values will cause the transmitter output to drop, and may lead to TVI or BCI reports.

CAUTION:

For protection against fire, electric shock, personal injury, or damage to the radio, use a lightning arrester in your antenna lines.

4. OPERATION

4-1. OPERATING CONTROLS

4-1-1. Front Panel

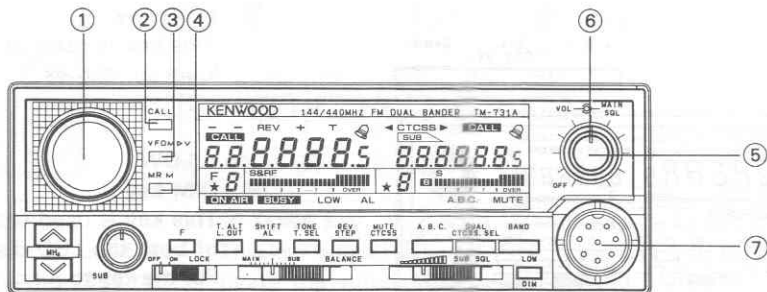

① Main Tuning control

This control is used to select the desired transmit/receive frequency, Memory Channel, Frequency Step, Tone Frequency, and Scan direction of the MAIN frequency band.

② CALL key

The CALL key selects the CALL channel of the MAIN frequency band. The frequency may be reset to any desired frequency. (See CALL Channel P26.)

③ VFO key

This key is used to return to VFO operation after operating in the MR (Memory Recall), or CALL Channel mode. The MAIN tuning control will increase frequency in the selected step size, the tone frequency, and/or the frequency step.

Press and hold the key for longer than 1 second to initiate VFO scan. Press the key after scan has been initiated will cause scan to stop.

④ MR key

This key is used to select Memory Recall operation after operating in the VFO or CALL channel mode. The MAIN Tuning control may be used to select the desired

memory channel in this mode.

Press and hold the key for longer than 1 second to initiate MR scan. Press the key after scan has been initiated will cause scan to stop.

⑤ VOL control/Power switch

The volume control and power switch are combined. Rotating the control clockwise will turn ON the transceiver.

Advancing the control further clockwise will increase the total volume of two bands.

The BALANCE control proportions the volume among the two bands.

⑥ MAIN SQL control

This control is used to select the desired SQL threshold level of the MAIN frequency band.

⑦ Microphone connector

Plug the standard or optional microphone into this jack.

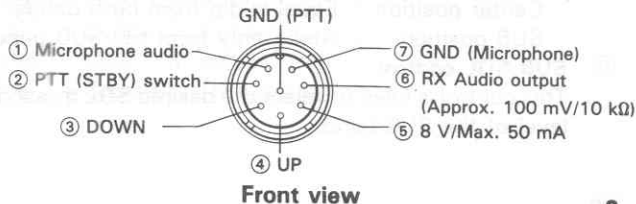

Front view

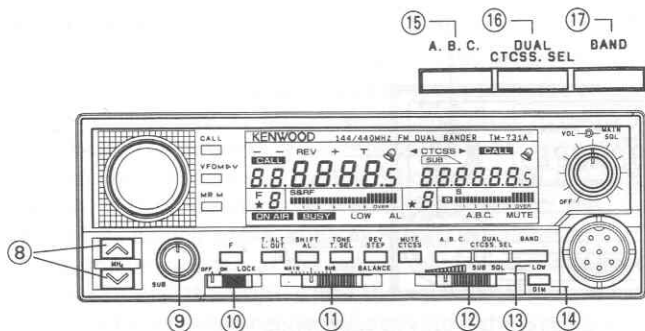

⑧ **MHz key**

This key is used to change frequency in 1 MHz steps during VFO operations. Pressing and holding the key will continuously change the frequency in 1 MHz steps.

⑨ **Sub Tuning control**

This control is used to select the desired receive frequency and Memory channel of the SUB band.

⑩ **LOCK switch**

This key will deactivate all functions except the PTT switch.

⑪ **BALANCE control**

This control proportions the total audio volume among the two bands.

MAIN position : Audio only from the MAIN band

Center position : Equal audio from both bands

SUB position : Audio only from the SUB band

⑫ **SUB SQL control**

This control is used to select the desired SQL threshold level of the SUB band.

⑬ **LOW key**

This key is used to select the transmit output power level as follows:

HI (no indicator) : 144 MHz:50 W/220 MHz:25 W/
430 MHz:35 W
LOW : 5 W

⑭ **DIM key**

This key is used to select either high or low intensity of both the LCD display and control's illuminations. For the key to function, it must be pressed within 5 seconds after pressing the F key.

⑮ **A.B.C. (Automatic Band Change)**

When this key is pressed, the contents of the SUB band will be transferred to the MAIN band whenever a signal is received at the SUB band antenna, which is strong enough to open the squelch. The contents of the MAIN band are transferred to the SUB band at the same time.

⑯ **DUAL band**

This key is used to turn the SUB band ON or OFF.

CTCSS SEL (With the TSU-6)

Pressing the key within 5 seconds of pressing the F key will switch the CTCSS function alternately between the UHF band and VHF band. (To activate the CTCSS function use the CTCSS key.)

During scan press the key to initiate double scan.

⑰ **BAND key**

This key is used to change the contents of the MAIN band.

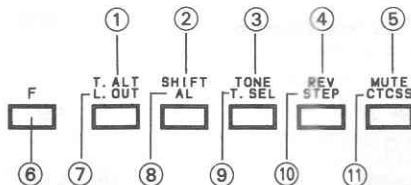
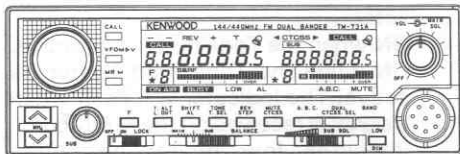

① T.ALT Key

This key is used to turn the Tone Alert function ON or OFF.

② SHIFT key

This key is used to select the desired transmitter offset during repeater operations. When the key is pressed the shift mode cycles from + to - [- to - - (European version)] to simplex (no indicator).

③ TONE key

This key is used to activate the subaudible tone encoder.

④ REV key

This key is used to reverse the transmit/receive frequencies during repeater operations. This will allow you to check the input of the repeater or to operate on a reverse repeater pair.

⑤ MUTE key

This key is used to reduce the volume of the SUB band (Approximately 20 dB).

⑥ The F key is activate these keys below for 5 seconds after pressing the key, and during the "F" indicator is ON.

⑦ L. OUT key

This key is used to temporarily skip unwanted Memory Channels during the Memory Channel Scan mode.

⑧ AL key

This key is used to check Memory Channel 1 at approx. 5 second intervals. If the channel is busy, a beep will sound.

⑨ T. SEL key

This key is used to switch to the tone frequency selection mode. The MAIN Tuning control can then be used to select the desired tone frequency.

⑩ STEP key

This key is used to switch to the frequency selection mode during VFO operation. The MAIN Tuning control can then be used to select the desired frequency step.

⑪ CTCSS key

With the TSU-6: This key is used to activate the CTCSS function.

Display panel

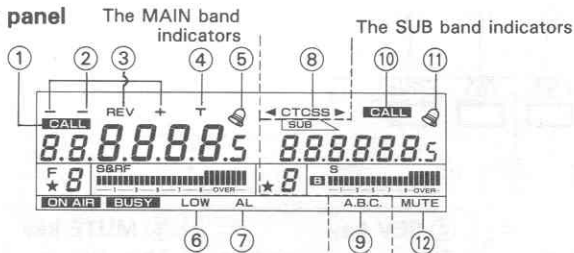

The MAIN band Indicators

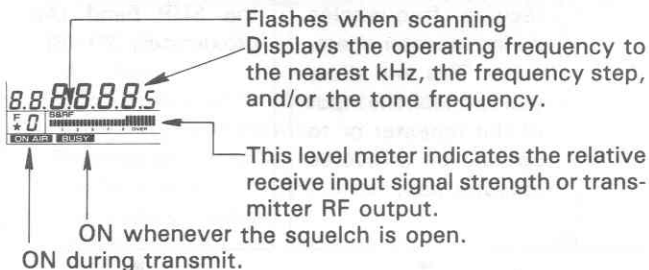

ON whenever the F key is depressed. (Always displays the last Memory Channel number that had been selected.)



Displays the current Memory Channel number. The ★ indicator is ON when the Memory channel will be skipped during Memory Channel Scan.



ON when the CALL channel is ON. Displays the selected transmitter offset direction.

(TM-731E)

③ REV

ON when the Reverse function is active.

④ T

ON when the Tone function is active.

⑤



ON when the Tone Alert System is active. The indicator will flash when a signal is received on the MAIN band.

⑥ LOW

Indicates low power has been selected.

⑦ AL

ON when the Priority Alert system is active.

Common indicator

⑧



With the TSU-6; ON when the CTCSS function is active.

⑨ A.B.C.

Displays the selected CTCSS band. ON when the A.B.C. (Automatic Band Change) function is ON.

The SUB band indicators

⑩



Flashes when scanning.

⑪



Displays the receive frequency.

Indicates relative signal strength during reception.

ON whenever the squelch is ON.

Displays the current Memory Channel number.

The ★ indicator is ON when the Memory channel will be skipped during Memory Channel Scan.

⑩ CALL

ON when the CALL channel is ON.

⑪



ON when the Tone Alert System is active. The indicator will flash when a signal is received on the SUB band.

⑫ MUTE

ON when the volume of the SUB band is reduced.

4-1-2. Rear Panel

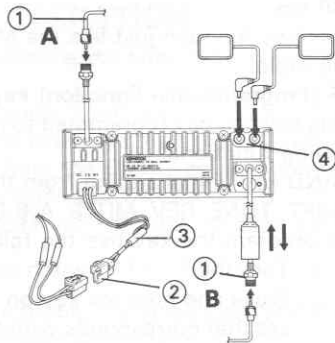

① ANT (Antenna) connector

Attach an antenna with an impedance of 50 ohms to this connector.

A for 144 MHz

B for 220 MHz (TM-631A)

430 MHz, 440 MHz (TM-731A/731E)

② 13.8 VDC power input connector

Connect the supplied DC Power Cable to this connector. Pay close attention to the polarity (the DC Power Cable is color-coded; red is positive and black is negative), when connecting the cable to the power source.

③ Fuse holder

Contains a fuse (15A).

④ SP (Speaker) jack

These jacks are for connection of 8-ohm external speaker.

- When connect a speaker to MAIN/SUB jack, audio signals from both bands will be heard only from the external speaker. (Fig. 1)
- When connect a speaker to MAIN jack, audio from MAIN band will be heard from the external speaker and audio from SUB band will be heard from the transceiver's internal speaker. (Fig. 2)
- When connect two speakers to both jack, audio from the MAIN band will be heard from the external speaker connected to the MAIN jack. Audio from the SUB band will be heard from the external speaker connected to the MAIN/SUB jack (Fig. 3)

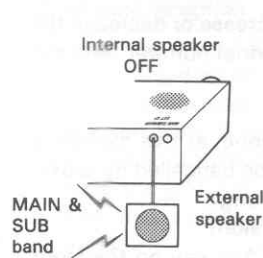

Fig. 1

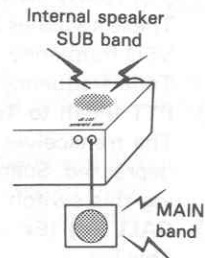

Fig. 2

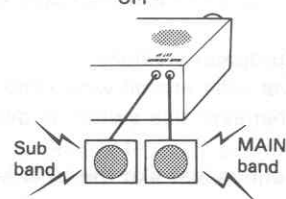
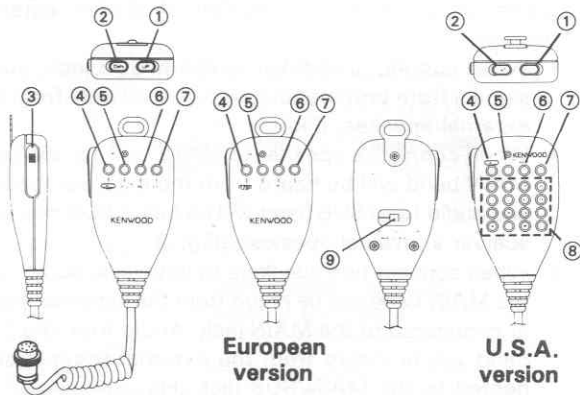

Fig. 3

Microphone



① ② UP/DWN switches

These switches can be used to increase or decrease the VFO frequency, the Memory channel number, and the Tone frequency, ect.

③ PTT (Push to Talk) switch

The transceiver will transmit whenever this switch is depressed. Scan operations may be cancelled by pressing this switch without transmitting.

④ CALL key (Except European Version)

This key functions just like the CALL key on the front of the radio.

1750 key (European version)

The transceiver will transmit with 1750 Hz repeater access tone whenever this switch is depressed.

⑤ VFO key

This key functions just like the VFO key on the front of the radio.

⑥ MR key

This key function just like the MR key on the front of the radio.

⑦ PF (Programmable Function) key

This key can be programmed to perform any of the following functions:

BAND key (Initial setting from the factory); or T.ALT, SHIFT, TONE, REV, MUTE, A.B.C, DUAL, or LOW key.

To program the key use the following procedure:

1. Turn the POWER switch on the transceiver OFF.
2. Press and hold the key on the front panel of the set that corresponds with the function you wish to program the microphone key to perform.
3. Turn on the POWER switch while the key on the front panel is held in.
4. Release the front panel key.

One additional function can be programmed that is not included on the front panel of the transceiver. This is known as the MONITOR function. This will allow you to open squelch of the MAIN band, to check the band for a clear frequency. This will function even if you are operating in the CTCSS decode mode.

MONITOR programming

Press and hold the F key on the front panel as you turn on the POWER switch of the transceiver and then release the F key.

⑧ 16-Tone DTMF keypad (U.S.A. version only)

These buttons are used to activate the DTMF encoder. See 4-4-4. for further information on their use.

⑨ LOCK key

This key will deactivate all functions of the microphone except the PTT function and DTMF keypad.

4-2. RECEIVER OPERATION

The transceiver will supply audio confirmation whenever a function is activated.

If you would not like audio confirmation when a function (except Priority Alert) is activated, turn the POWER switch OFF. Then press and hold the CALL key and turn ON the power switch, then release the CALL key. Repeating this procedure will turn the function back ON.

4-2-1. Reception

1. Connect the power supply and antennas, and then set the switches and controls as follows:

POWER (VOL) control : OFF (Fully counterclockwise)
POWER switch of the DC power supply (Fixed Station)

: OFF

MAIN SQL control : Fully counterclockwise

SUB SQL control : Full left

BALANCE control : Full left (MAIN)

LOCK switch : OFF

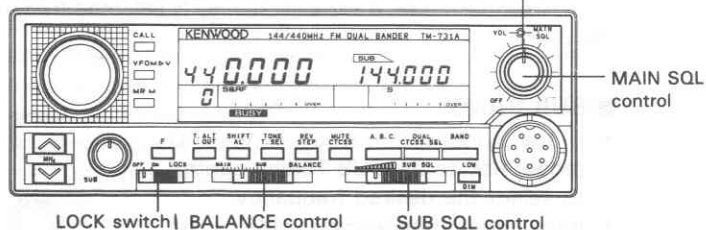



Fig. 1

2. Turn ON the DC power supply and then turn the transceiver's power switch ON. The display panel will indicate as shown in Fig. 1. Additionally some control and key lights will turn on.

Note:

If the display is not as shown Fig. 1 reset the microprocessor using the procedure give in Microprocessor memory Initialization Page 23.

3. Turn the VOL control clockwise until a signal or noise from MAIN band frequency is heard.
4. Rotate the MAIN Tuning control and select an open channel. Then, turn the MAIN SQL control clockwise until the noise disappears and the BUSY indicator goes OFF (Threshold point).
5. Slide the BALANCE control full right (SUB).
6. Rotate the SUB Tuning control and select an open channel. Then slide the SUB SQL control to the right until the noise disappears and the  indicator goes OFF.

Dual band reception (Simultaneous reception on both bands)

1. Slide the BALANCE control to the middle.
2. Select the desired frequencies in each band. When each signal is received, the BUSY or the  indicator will turn ON and each S-meter will deflect.
3. To distribute volume among MAIN band and SUB band, slide the BALANCE control to the desired point. The VOL control regulate the amount volume of two bands.

Single band reception

Press the DUAL key. The SUB band frequency display will turn off.

Caution:

Turn off the transceiver's POWER switch before you turn off the power supply, or if in a vehicle, before you stop the engine.

4-2-2. Frequency Selection

Frequency can be changed in the VFO mode. The selected frequencies of the main band can be stored in the Memory channels, and the Call channel.

(See Memory Entry page 23, CALL CHANNEL page 25.)

You can select the VFO mode, MEMORY Channel mode, and CALL Channel mode using the following keys.

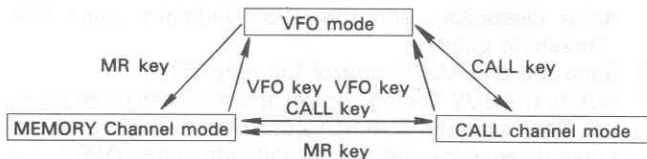

It is impossible to change the mode directly in the SUB band. It is possible to transfer the mode of the MAIN band to/from SUB band.

Exchange the Band

Press the BAND key. Each time the BAND key is pressed, the contents of the SUB band are exchanged with the MAIN band.

■ MAIN BAND

● VFO mode

1. Press the VFO key to select the VFO mode.
2. Rotate the MAIN Tuning control, MHz keys, or Microphone UP/DWN switches to select the desired frequency.

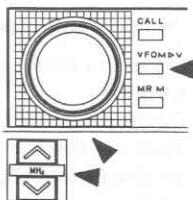

● Memory Recall mode

1. Press the MR key. The previously selected memory channel will be displayed on the LCD display.
2. Rotate the MAIN Tuning control or Microphone UP/DWN switches to select the desired Memory Channel.
3. To return to the VFO mode press the VFO key.

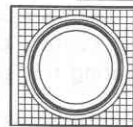
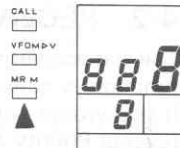

● CALL Channel mode

1. Press the CALL key to select the CALL Channel mode. The CALL indicator and the call channel frequency are displayed on the LCD display.
2. To return to the previous mode press the CALL key again.

Note:

The Memory Channel number will not disappear during the CALL Channel mode, if the call channel is selected from the MR mode.

■ SUB BAND

- If the current frequency is in VFO mode; Rotate the SUB Tuning control to select the desired frequency.
- If the current frequency is in MR mode; Rotate the SUB Tuning control to select the desired Memory Channel.
- Current frequency is in CALL Channel mode; Frequency can not be changed in the SUB band.



4-2-3. Frequency Step Selection

The frequency step is factory-set to the following;

| | TM-631A | TM-731A | TM-731E |
|------------------|---------|---------|----------|
| 144 MHz Band | 5 kHz | 5 kHz | 12.5 kHz |
| 220 MHz Band | 20 kHz | — | — |
| 430/440 MHz Band | — | 25 kHz | 25 kHz |

The frequency step can be selected by using the following procedures:

MAIN Band

1. Press the VFO key to select the VFO mode.
If you are already in the VFO mode you can skip this step.
2. Press the F key. The F indicator will be displayed on the LCD display.
Press the REV/STEP key within 5 seconds. (If the indicator goes off, you must press the F key again.) The current frequency step will be displayed on the LCD display.

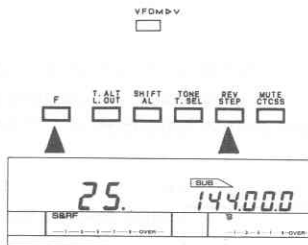

3. Rotate the Tuning control or press the Microphone UP/DWN switch to select the desired frequency step. The accompanying figure shows how the Tuning control will increase or decrease the step size.
4. To complete the Frequency step selection press the VFO key or any other key. Automatically return 5 seconds of the selection.

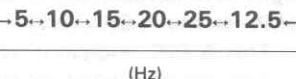
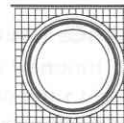

| | MAIN Tuning control | Microphone UP/DWN switches |
|---|--------------------------|----------------------------|
| → | Rotate clockwise | Press UP key |
| ← | Rotate counter-clockwise | Press DWN key |

SUB Band

It is impossible to select the Frequency Step directly while in the SUB Band. It is possible to transfer the selected Frequency Step of the MAIN band to the SUB band. Press the BAND key.

4-2-4. A.B.C. (Automatic Band Change)

The A.B.C. function allows you to exchange the contents of SUB band to the MAIN band automatically whenever a signal is received in the SUB band and SUB squelch is open.

1. Press the A.B.C. key.

The A.B.C. indicator will turn on displayed in the LCD display.



2. As soon as a signal is received in the SUB band, exchange the bands.*

Caution:

* The Tuning controls are not effective during this exchange.



3. If press the PTT switch, A.B.C. function is released.



3. If does not press the PTT switch 3 seconds after the signal goes off, the MAIN band return to SUB band.



3. If press the BAND key the MAIN band return to SUB band and all the keys and Tuning control are effective.



The A.B.C. function can always be released by pressing the PTT switch.

Note:

When using A.B.C. function with the T.ALT system press the PTT switch twice to release the A.B.C. function.

4-3. TRANSMITTER OPERATION

Caution:

1. Ensure that an antenna with a low standing wave ratio (SWR) is attached to the antenna connector before attempting to transmit. Failure to provide proper termination may result in damage to the final amplifier section.
2. Always check to ensure the frequency is clear before transmitting.

Note:

The use of LOW power is recommended, whenever possible, to avoid interfering with other stations.

Transmit

1. Select the desired operating frequency in the MAIN band using any of the methods previously discussed.
2. Check the frequency to see if it is occupied before you transmit.
3. Press the PTT switch. The ON AIR indicator will light, and the RF meter will deflect to the right.

Note:

If you have selected the LOW power position, the low indicator will appear in the display and the RF meter will only deflect slightly. When HI power has been selected the RF meter will swing full scale.

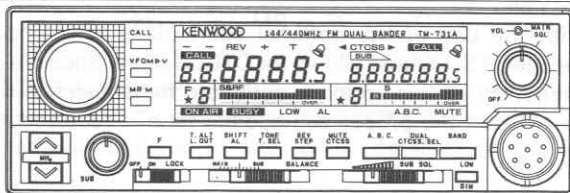

4. Speak into the microphone. The recommended distance to the microphone is 5 cm (2 inches).

Note:

Talking closer may result in overdeviation of your transmit signal, which might be reported as a loss of clarity or of an excessively wide transmit signal. Talking too far away may result in reports of weak audio.

5. Release the PTT switch to return to the receive mode. The ON AIR indicator should go out, and the RF meter will return to zero.

Duplex Operation

Pushing the PTT switch on the microphone allows the simultaneous reception in the SUB band frequency and sending in a MAIN band frequency.

Note:

With certain relationship between the sending and receiving frequencies, the receiver sensitivity may be suppressed.

4-4. REPEATER OPERATION

4-4-1. TRANSMITTER OFFSETS

All amateur radio repeaters utilize a separate receiver and transmitter section. The receiver frequency may be either above or below the transmitter frequency.

For most repeaters offsets are as follows:

| Band | 144 MHz | 220 MHz | 430/440 MHz | |
|---------|-------------------------------|-----------|-------------|-----------|
| Model | TM-631A TM-731A TM-731E | TM-631A | TM-731A | TM-731E |
| Display | | | | |
| + | + 600 kHz | + 1.6 MHz | + 5 MHz | + 1.6 MHz |
| - | - 600 kHz | - 1.6 MHz | - 5 MHz | - 1.6 MHz |
| - - | | | | - 7.6 MHz |

• Offset Direction

To select the desired transmitter offset direction press the SHIFT key. Each time you press the key the transceiver will advance from one offset to the other, i.e. + to - (- to - - with European version) to no offset (simplex).

The transceiver allows you to store the frequency, and offset in memory, or you can select these functions directly from the keyboard.

• Auto-Offset (TM-631A/731A, U.S.A. version)

The TM-631A/731A have been programmed according to the standard ARRL Band Plan, regarding transmitter offsets. Please see the accompanying chart for additional information. You can, of course, override this by using the SHIFT function, if desired.

| | | | | | |
|---------|--------|---------|---------|--------|--------|
| 144.00 | 145.10 | 146.00 | 146.60 | 147.40 | 148.00 |
| S | S | - | S | + | S |
| | | | | | |
| | 145.50 | 146.40 | 147.00 | 147.60 | |
| | | | | | |
| 220.000 | | 223.920 | 224.995 | | |
| S | | S | - | S | |

4-4-2. REVERSE FUNCTION

Some repeaters utilize a "Reverse pair", i.e. the transmit/receive frequencies are exactly the reverse of another repeater. For example repeater A uses 146.000 for a transmit frequency (OUTPUT) and 146.600 for receive (INPUT). Repeater B uses 146.000 for its receive and 146.600 for its transmit frequency. It would be inconvenient to have to reprogram the transceiver each time if you were in range of both repeaters.

The REV key allows you to reverse the transmit and receive frequencies. To use the REVERSE function press the REV key. The offset indicator (+ or - / - or - -) will light in the display to remind you that you are working a reverse repeater pair.

To return to normal offsets press the REV key again. This function is also useful to check the input frequency of the repeater, so that you can determine if you are within SIMPLEX communications range.

4-4-3. TONE OPERATION

Some repeaters require the use of a control signal to activate the repeater. Several versions are currently in use worldwide.

In the United States sub-audible tones are sometimes used. 38 different sub-audible tone frequency selections are possible.

With the use of the optional sub-audible tone encoder/decoder (TSU-6) also allows for CTCSS (Tone Squelch) operations. When this option is activated the squelch will only open when the proper sub-audible tone is received.

In Europe a 1750 Hz tone is used in transmit. Press and hold the Microphone 1750 key to transmit with the access tone, you need not press the PTT switch.

Since use of this tone is required in the Europe and the United Kingdom, a 1750 Hz tone encoder is included with models delivered to these countries.

• Tone Activation

To activate the TONE function depress the TONE key. The T indicator will appear in the display to signify the tone has been activated. To turn the tone OFF press the TONE key again.

Tone frequency selection

1. Press the F key and then TONE/T.SEL key.

The current tone frequency will be displayed.

2. Rotate the MAIN Tuning control or press the Microphone UP/DWN switches until the desired tone frequency appears in the display.
3. To turn to the normal frequency display, press the TONE key, any one of the keys, Microphone PTT switch, CALL, VFO, MR or PF key. Or automatically release after 5 seconds of the selection.

• CTCSS Activation

When the CTCSS indicator appears in the display the transceiver will operate in the TONE squelch mode, i.e.

Tone Frequency

| | | |
|------------|----------|----------|
| 67.0 Hz | 107.2 Hz | 167.9 Hz |
| 71.9 Hz | 110.9 Hz | 173.8 Hz |
| 74.4 Hz | 114.8 Hz | 179.9 Hz |
| 77.0 Hz | 118.8 Hz | 186.2 Hz |
| 79.7 Hz | 123.0 Hz | 192.8 Hz |
| 82.5 Hz | 127.3 Hz | 203.5 Hz |
| 85.4 Hz | 131.8 Hz | 210.7 Hz |
| 88.5 Hz | 136.5 Hz | 218.1 Hz |
| 91.5 Hz | 141.3 Hz | 225.7 Hz |
| 94.8 Hz | 146.2 Hz | 233.6 Hz |
| (97.4 Hz) | 151.4 Hz | 241.8 Hz |
| 100.0 Hz | 156.7 Hz | 250.3 Hz |
| 103.5 Hz | 162.2 Hz | |

Note: 97.4 Hz is available only for encode.

Squelch will not open until the same tone is received as a portion of the incoming receive signal.

DUPLEX OPERATION

1. Press the F key. The F indicator will light.
2. Press the DUAL/CTCSS SEL key within 5 seconds of pressing the F key. Alternately the ◀ or ▶ indicator will light. Select the band that you want for tone squelch operation.
3. Press the F key and then press the MUTE/CTCSS key. The CTCSS indicator will be displayed.
4. To turn off the CTCSS function, press the F key and then the MUTE/CTCSS key again.



SIMPLEX OPERATION

1. Press the F key. The F indicator will light.
2. Press the MUTE/CTCSS key within 5 seconds of pressing the F key. The ◀ CTCSS indicator will light.
3. To turn off the CTCSS function, press the F key and then the MUTE/CTCSS key again.



4-4-4. AUTOPATCH (U.S.A. version only)

Some repeaters offer a service known as autopatch. This allows you to dial a telephone number from your transceiver and carry out a telephone conversation, much like a car telephone, or cellular telephone. This function requires the use of a DTMF (Dual Tone Multi Frequency) pad. In addition to the normal 12 keys that are found on your telephone the MC-44DM microphone also provides 4 additional keys, A, B, C, and D. These keys are required by some repeater systems for various control functions. You should check with the control operator of your repeater to determine if their use is required. A chart is provided that lists the tones that are generated when you press each key.

1. To activate the DTMF pad, press and hold the PTT switch.
2. Now press the keys just as you would dial a telephone.
3. The transceiver will remain keyed for about 2 seconds after you press each number, so you can release the PTT switch without unkeying the transceiver.

Note: _____

Some repeaters will require a special sequence of keys to activate the Autopatch. Again you should check with the control operator of your repeater for this sequence.

Audio tones (Hz)

| Column Row | 1209 | 1336 | 1477 | 1633 |
|---------------|------|------|------|------|
| 697 | 1 | 2 | 3 | A |
| 770 | 4 | 5 | 6 | B |
| 852 | 7 | 8 | 9 | C |
| 941 | * | 0 | # | D |

4-5. MEMORY

4-5-1. Microprocessor memory back-up

A lithium battery is contained in the transceiver to retain memory. Turning off the POWER switch, disconnecting the power cable, or a power failure will not erase the memory. The battery should last for approximately five years. When the battery discharges, an erroneous display may appear in the display.

Lithium battery replacement should be performed by an authorized KENWOOD service facility; either your KENWOOD dealer, or the factory, since this unit contains CMOS type circuitry.

4-5-2. Microprocessor Initialization

- Initial state of the microprocessor from the factory.

| | MAIN BAND | | SUB BAND |
|-------------------------|--------------------|--------------|----------|
| | TM-631A | TM-731A/731E | |
| VFO | 220 | 430/440 | 144 |
| Memory Channel 0~9, A~d | 220 | 430/440 | 144 |
| CALL Channel | 220 | 430/440 | 144 |
| Scan resume mode | Time operated scan | | |
| microphone PF key | BAND key | | |

(MHz)

- Microprocessor Initialization

When you want to erase all programmed data, or if the display should show erroneous information, you should initialize (reset) the microprocessor using the following procedure.

1. Turn the POWER switch off.
2. Press and hold the MR key and turn on the POWER switch.
3. Release the MR key.

4-5-3. Memory Channel

This transceiver provides 14 Memory Channels (0-9, A-d). In addition to serving as a normal memory channel some of the Memory Channels serve a dual purpose to specify other parameters. The functions of these Memory Channels are described below.

- * Memory Channel 1 is used to store the frequency for the Priority Alert function.
- * Memory Channel A is used to store the lower limit for the Programmable Band Scan function.
- * Memory Channel b is used to store the upper limit for the Programmable Band Scan function.
- * Memory Channel C and d are used to store odd split repeater data.

4-5-4. Memory Contents

Each Memory Channel is capable of storing;

| Memory Channel | 0~9, A, b | C, d | CALL |
|---------------------|--------------|------|------|
| Frequency data | ○ | ○ | ○ |
| Tone Frequency data | ○ | ○ | ○ |
| Tone ON/OFF | ○ | ○ | ○ |
| SHIFT status | ○ | X | ○ |
| REVERSE ON/OFF | ○ | X | ○ |

4-5-5. Memory Entry

Memory Entry must be done in MAIN band.

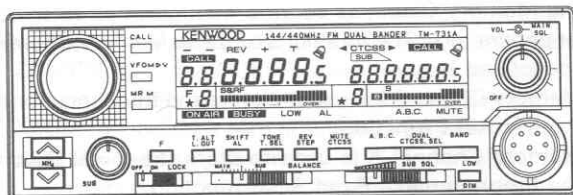

■ Simplex/Normal SHIFT (M.ch 0~9, A and b)

1. Select the desired operating frequency, offset, tone frequency, etc. (For example 146.100 MHz + shift)

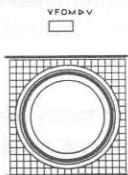

2. Press the F key. The F indicator and the memory channel indicator will light. (For example ch 8.)

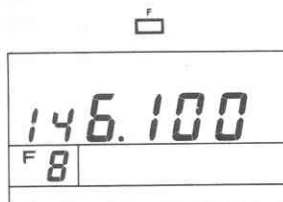

3. Select the desired Memory Channel using the MAIN Tuning control or the microphone UP/DWN switches.

Note:

You must do this within 5 seconds of pressing the F key, or the F indicator will turn off. If the indicator goes off, you must press the F key again.

4. Press the MR key within 5 seconds of selecting the Memory Channel.

Note:

If the indicator goes off, you must press the F key again in order to complete the desired function.

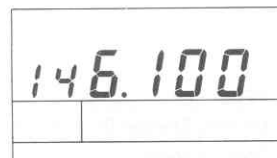
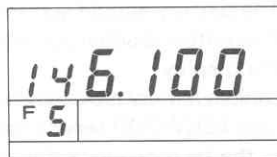
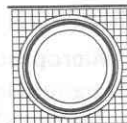

After pressing the MR key the F indicator will turn OFF, and the transceiver will return to the previous mode.

■ Odd Split Channels (M.ch C, and d)

1. Select the desired receiving frequency, Tone frequency, etc. (For example 147.430 MHz)

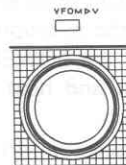

- Press the F key. The F indicator and the memory channel indicator will appear. (For example 5 ch)
- Select Memory Channel C or d using the MAIN Tuning control or the microphone UP/DWN switches. (For example ch d)

Note:

You must do this within 5 seconds of pressing the F key, or the F indicator will turn off. If the indicator goes off, you must press the F key again.

- Press the MR key within 5 seconds of selecting Memory Channel C or d.

Note:

If the indicator goes off, you must press the F key again.

After pressing the MR key the F indicator will remain on and the Memory Channel number will turn off.

- Within 5 second of pressing the MR key, select the transmitting frequency using the MAIN Tuning con-

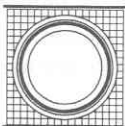
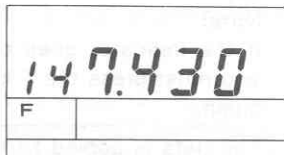
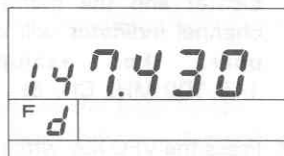
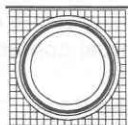

trol or the microphone UP/DWN switches. (For example 146.430 MHz)

- Press the MR key within 5 seconds of selecting the transmitting frequency. The F indicator goes off signaling Split Memory Channel Entry is complete.

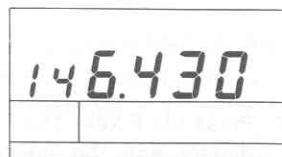
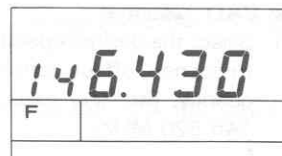

- To confirm the contents of the Split Memory press the MR key and recall the desired channel (C or d). The receiving frequency will appear in the display.

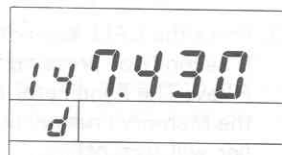

- Press the REV key. The transmitting frequency will appear in the display.

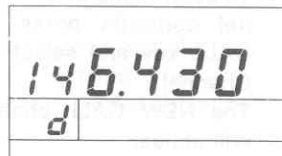

■ CALL Channel

1. Select the desired operating frequency, offset, tone frequency, etc. (For example 146.520 MHz)

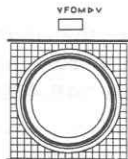

2. Press the F key. The F indicator and the memory channel indicator will light. (For example ch d)



3. Press the CALL key within 5 seconds of pressing the F key. The F indicator and the Memory channel number will turn off.

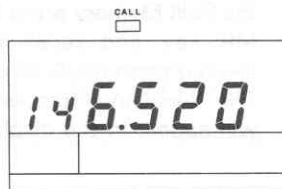

4. To confirm the CALL channel contents press the CALL key and select the Channel. The NEW CALL channel will appear.



4-5-6. Memory Recall

Please refer to Frequency Selection page 16.

4-5-7. Memory Shift

This feature copies memory channel or CALL channel data to the VFO.

This will allow you to after these frequencies without changing the actual contents of the memory or CALL channel.

1. Press the F key. The F indicator and the memory channel indicator will appear. (For example 146.100 MHz CH. 8)



2. Press the VFO key within 5 seconds of pressing the F key.

Note: _____
If the indicator goes off, you must press the F key again.

The data is copied to the VFO mode.

Note: _____
If an Odd split Memory Channel (C or d) is selected, only the receive data will be copied.



4-6. SCAN

4-6-1. Scan Options

The following scan options are available:

PROGRAMMABLE BAND SCAN

The Scan frequency range is determined by the frequencies stored in Memory Channels A and b. (VFO mode)
BAND SCAN

Scan proceeds over the entire band (VFO mode).
MEMORY CHANNEL SCAN

Scan proceeds thru those memory channels that actually have data entered and have not been locked out. (Memory Channel Mode)

DOUBLE SCAN

Scan proceeds simultaneously on the both bands.
Scan will not function when the Tone Alert System is active.

4-6-2. HOLD/RESUME PROGRAMMING

Two type of scan hold/resume have been provided in this transceiver.

Time Operate scan

You may prefer that the radio stops on a busy channel and remains there approximately 5 seconds, and then continues to scan even if the signal is still present.

Carrier Operated scan

In this mode the radio will stop scanning on a busy channel and remain there until the signal drops out. The radio allows a 2 second delay before it resumes scanning so that you don't lose the station when operators change.

This transceiver is delivered from the factory in the Time

operated scan mode. To switch between the two modes use the following procedure.

1. Turn the power switch OFF.
2. Press and hold the VFO key and turn ON the power switch.
3. Release the VFO key.
4. To return to Time operated mode repeat steps 1 ~ 3.

4-6-3. PROGRAMMABLE BAND SCAN/BAND SCAN

1. The lower scan limit must be stored in Memory channel A. The higher scan limit must be stored in Memory channel b.
Caution: _____

If the frequency in Memory Channel A is equal to or greater than the frequency stored in Memory channel b scan will proceed over the entire band "BAND SCAN".

(For the Memory Entry, refer to MEMORY ENTRY page 24.)

2. Press the VFO key to select the VFO mode.
3. Adjust the SQL control to the threshold point.
4. Select a VFO frequency between the two scan limits.
5. Press the VFO key for longer than 1 second to initiate scan. The MHz "●" indicator will flash as a visual reminder that the transceiver is scanning.
6. Scan will begin in an upwards direction. You can reverse the direction by rotating the MAIN Tuning control counterclockwise, or by pressing the microphone UP/DWN switch. The scan step size depends upon the current step programming.
7. Scan will stop whenever a signal is received (that activates the BUSY indicator) for a limited time.
8. Press the VFO key, the microphone PTT switch or VFO key to clear scanning.

4-6-4. MEMORY CHANNEL SCAN

1. Press the MR key to select the Memory Channel mode.
2. Adjust the SQL control to the threshold point.
3. Press the MR key for longer than 1 second to initiate scan. The MHz "●" indicator will flash as a visual reminder that the transceiver is scanning.
4. Scan will begin at the current memory channel and proceed sequentially. i.e. M1 → M2 → M3 etc.
5. Scan will stop whenever a signal is received (that activates the BUSY indicator) for a limited time.
6. Press the MR key the microphone PTT switch or MR key to clear scanning.

4-6-5. DOUBLE SCAN

1. Adjust the MAIN and SUB SQL controls to the threshold point.
2. Press the VFO key (VFO scan) or MR key (MR scan) for longer than 1 second to initiate scan.
3. Press the DUAL key while scan is in progress. The MHz "●" indicators of both bands will flash.
4. Press the DUAL key again to clear DOUBLE SCAN function.
Press the microphone PTT switch, or VFO/MR key to clear SCAN.

4-6-6. Priority Alert

Memory channel 1 will be checked at approximately 5 second intervals to check for activity when this function is selected.

1. Enter the frequency that you wish to monitor in memory channel 1 of the MAIN BAND (See Memory Entry page 23).

2. Adjust the SQL control to the threshold point.
3. Press the F key and then SHIFT/AL key.
"AL" indicator will appear on the LCD display.
If the channel is busy, a beep will sound.

Note:

1. The Priority Alert function will ignore CTCSS programming. The priority Alert works off of signal levels only (Busy ON/OFF).
 2. During the period channel 1 is being monitored, only the beep will sound.
4. Press the F key and then SHIFT/AL key again.
"AL" will disappear, disabling the Priority Alert function.

4-6-7. Memory Channel Lockout

The Memory Channel Lockout function allows you to temporarily skip unwanted Memory Channels during Memory Channel Scan.

1. Press the MR key to select the Memory Channel mode.
2. Select the Memory Channel that you wish to skip by using the MAIN Tuning control or the microphone UP/DWN switches.
3. Press the F key and then the T.ALT/L.OUT key.

Whenever the F key is pressed, the F indicator will turn ON.



Note:

You must complete the desired action within 5 seconds, or the F indicator will turn OFF. If the indicator goes off, you must press the F key again.

A star (★) will appear to the left of the Memory Channel number. This indicates the Memory Channel will be skipped during Memory Channel Scan operations.



4. Repeat steps 2 and 3 to lockout any other Memory Channels that you want to skip.
5. To cancel the lockout, select the desired Memory Channel as described in steps 1, 2, and 3 above. The star (★) will go out. The Memory Channel will now be scanned normally.

4-7. TONE ALERT SYSTEM

The Tone Alert function will provide an audible "alarm" to signal when someone is transmitting on the frequency you are monitoring on both bands.



1. Adjust each SQL control to the threshold point.
2. If you will be using the TSU-6 for CTCSS decode you should select the desired tone frequency and then press the F key and CTCSS key. Please refer to page 21.
3. Press the T.ALT/L.OUT key. T.ALT indicators will light.
4. When a signal is present: The T.ALT indicator will flash. The busy indicator will light. The transceiver will beep ON and OFF for approximately 10 seconds.

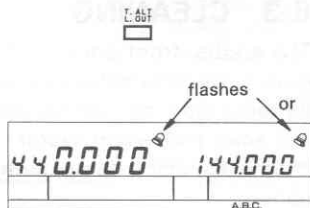

NOTE:

During in the T.ALT operation voice from MAIN band can be heard by using microphone MONITOR function (Please refer to page 14.).

When using CTCSS the incoming signal must be present for approximately 1 second in order for the T.ALT to function properly.

5. The T.ALT function can be released by pressing the T.ALT/L.OUT key again, or pressing the PTT switch.

6. MAINTENANCE

6-1. GENERAL INFORMATION

Your transceiver has been factory aligned and tested to specification before shipment. Under normal circumstances the transceiver will operate in accordance with these operating instructions. All adjustable trimmers and coils in your transceiver were preset at the factory and should only be readjusted by a qualified technician with proper test equipment.

Attempting service or alignment without factory authorization can void the transceiver's warranty.

When operated properly, the transceiver will provide many years of service without requiring realignment. The information in this section gives some general service procedures which can be accomplished without sophisticated test equipment.

6-2. SERVICE

Should it ever become necessary to return the equipment to your dealer or service center for repair, pack it in its original box and packing, and include a full description of the problems involved. Also include your telephone number. You need not return accessory items unless directly related to the service problem.

Caution: _____

Do not pack the equipment in crushed newspapers for shipment. Extensive damage may result, during shipment.

Service note: _____

Dear OM, if you desire to correspond on a technical or operational problem, please make your note short, complete, and to the point, and PLEASE make it readable.

Please list: Model and Serial Number

The problem you are having.

Please give sufficient detail to diagnose. Information such as other equipment in the station, meter readings and anything else you feel might be useful in attempting diagnosis should be included.

Notes: _____

1. Record the Date of Purchase, Serial Number and Dealer from whom purchased.
 2. For your own information, retain a written record of any maintenance performed on the unit.
 3. When claiming warranty service, a photocopy of the bill of sale, or other proof of purchase showing the date of sale must accompany the radio.
-

6-3. CLEANING

The knobs, front panel and cabinet of the transceiver are likely to become soiled after extended use. The knobs should be removed from the transceiver and cleaned with a neutral soap and warm water. Use a neutral soap (no harsh chemicals) and a damp cloth to clean the cabinet and front panel.

6-4. IN CASE OF DIFFICULTY

The problems described in this table are failures caused, in general, by improper operation or connection of the transceiver, not by defective components. Examine and check according to the following table.

| Symptom | Probable cause | Corrective action |
|--|--|--|
| Indicators do not light and no receiver noise is heard when the POWER switch is turned on. | <ol style="list-style-type: none"> 1. Bad power cable or connections. 2. Blown power supply fuse. | <ol style="list-style-type: none"> 1. Check cables and connections. 2. Check for the cause of the blown fuse and replace the fuse. |
| No sound from the speaker. No signal can be received. | <ol style="list-style-type: none"> 1. Squelch is closed. 2. In the wrong BALANCE key position. 3. With the TSU-6: CTCSS is operating. | <ol style="list-style-type: none"> 1. Turn the SQL control counterclockwise. 2. Readjust the BALANCE key. 3. Press the F key and then MUTE/CTCSS key to turn off the CTCSS. |
| No transmitter output | <ol style="list-style-type: none"> 1. Microphone jack is not plugged in. 2. Poor antenna connection. | <ol style="list-style-type: none"> 1. Plug jack in. 2. Connect antenna securely. |
| Signals from the SUB band cannot be controlled by VOL control. | <ol style="list-style-type: none"> 1. MUTE is ON. 2. BALANCE key is switched to MAIN position. | <ol style="list-style-type: none"> 1. Press the MUTE key to clear MUTE. 2. Set the BALANCE key to center position. |
| Weak signal cannot be received. | <ol style="list-style-type: none"> 1. Poor antenna connection. | <ol style="list-style-type: none"> 1. Connect antenna securely. |
| Display is dark. | <ol style="list-style-type: none"> 1. Power voltage is low. 2. The DIM key had been pressed. | <ol style="list-style-type: none"> 1. Check voltage for 13.8 VDC \pm 15%. 2. Press the F key and the LOW/DIM key. |
| No control works. | <ol style="list-style-type: none"> 1. LOCK is ON. 2. During A.B.C. operation, being exchanging the bands each other. | <ol style="list-style-type: none"> 1. Set the Lock key to OFF position. 2. See A.B.C. Page 18. |
| Programmable band scan fails during 12.5 kHz VFO step. | <ol style="list-style-type: none"> 1. The frequencies stored in Memory Channels A and/or b are not in 12.5 kHz step. | <ol style="list-style-type: none"> 1. Make even the frequency steps. |
| Memory cannot be backed up. | Backup battery voltage is low. | See Microprocessor memory back-up page 23. |

7. OPTIONAL ACCESSORIES

7-1. CTCSS unit TSU-6

The use of the optional sub-audible tone decoder TSU-6 allows for CTCSS (Tone squelch) operations. When this option is activated the squelch will only open when the proper sub-audible tone is received.

7-1-1. Installation

Caution: _____

Before installation, be sure to disconnect the DC power cord, or damage may result to the transceiver or the unit.

1. Loosen the 2×2 side screws.
2. Remove the 2 screws securing the Top cover.
3. Remove the 2 screws securing the rear panel.
4. Gently remove the top cover. Be sure not to disconnect the wire to speaker.
5. Remove the backing from the cushion (small) that was provided the TSU-6 and attach it to the back of the TSU-6. (Fig. 2)

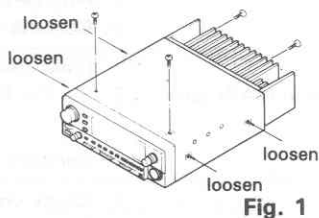

Fig. 1

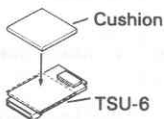

Fig. 2

6. Remove the resistor inserted into the connector. Attach the cable from TSU-6 as shown in the diagram. (Fig. 3)
7. Remove the backing from the other side of the cushion and attach the TSU-6 to the transceiver.

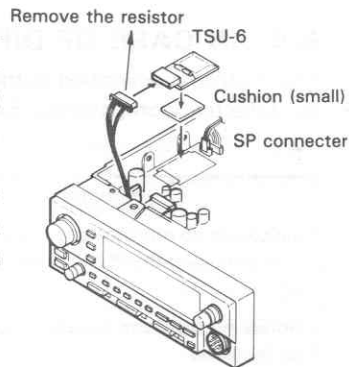

Fig. 3

8. Route the wiring as shown in the diagram. (Fig. 4)

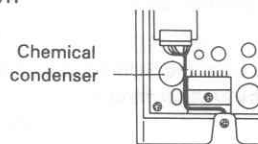

Fig. 4

9. Replace the covers and tighten the screws to complete the installation.

7-2. REMOTE CONTROLLER RC-10

CAUTION: _____

ENSURE THE TRANSCEIVER AND THE RC-10 ARE TURNED OFF BEFORE MAKING THE CONNECTION.

7-2-1. Reception

- Set the switches and controls as follows:
POWER (VOL) control : OFF (Fully counterclockwise)
POWER switch of the DC power supply (Fixed Station) : OFF
MAIN SQL control : Fully counterclockwise
LOCK switch : OFF
- Set the RC-10 switches as follows:
VOL MAIN/RMT switch : MAIN
Volume selection switch: minimum
- Turn on the DC power supply and then turn the transceiver ON. The display panels will indicate as shown below.

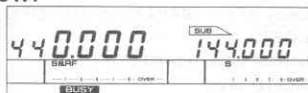

Transceiver



RC-10

- Noise or a signal will be heard from the RC-10 speaker. Select the desired volume level with the volume selection switch, on the side of the RC-10 handset.

Note: _____

RC-10 receives only from the MAIN band.

- Place the VOL MAIN/RMT switch to RMT. Noise or a signal can be heard from the transceiver's speaker. Adjust the volume with the VOLUME ▲/▼ keys on the RC-10 handset.

Note: _____

The VOL control of the transceiver is not effective during RMT operation.

- Rotate the MAIN Tuning control and select an open channel. The RC-10 numeric keys may also be used to select a frequency.
- Turn the MAIN SQL control clockwise until the noise disappears and the BUSY indicator goes OFF (Threshold point) on the transceiver.
- Select the desired frequency, VOL, and MAIN/RMT position.

Note: _____

Turn off the transceiver's POWER switch before you turn off the power supply.

7-2-2. Duplex operations with a single transceiver.

Note: _____

It is impossible to operate duplex operations if the transceiver is operating as follows.

- Single Bander
- A.B.C.

Example:

- To select a receive frequency in the MAIN Band, and a transmitter frequency in the SUB Band.



Transceiver

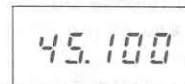

RC-10

- Press the F key and then 1 key of the RC-10. Press the PTT switch to transmit. The LCD display of the RC-10 displays the transmitter frequency that is the SUB band frequency.



Transceiver

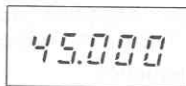

RC-10

Note:

The **DUP** indicator of the RC-10 is not ON with single transceiver duplex operation.

During the DUPLEX operation with a single transceiver, the LCD display of the transceiver indicates as follows:

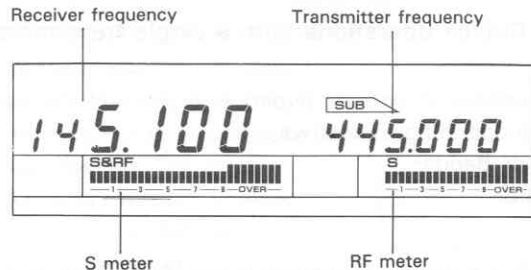

- To release Duplex operation, press the F key and then 1 key of the RC-10 again.

Note:

- The TONE frequency is selected in the MAIN band.
- During the DUPLEX operations, speaker output depends upon the following SQL conditions.
 - SQL is closed: No signal or noise is heard.
 - SQL is opened: The receiving signal or noise of the MAIN Band is heard.

SQL is controled by the MAIN SQL control of the transceiver. SQL can be controled by pressing the F key and then the 2 key of the RC-10.

7-2-3. Function Selection

The various control functions of the RC-10 when used with the TM-631A/731A/731E are as follows:

| Key operations | Function |
|----------------|---|
| F then 1 | Control duplex operation with single transceiver (ON/OFF) |
| F then 2 | SQL OFF/ON control |
| F then 3 | Shift selection |
| F then 4 | Reverse ON/OFF |
| F then 5 | Tone frequency of the MAIN Band (ON /OFF) |
| F then 6 | CTCSS ON/OFF |
| F then 7 | Memory Channel Lock out (ON/OFF) |
| F then 8 | Key Lock (RC-10 only) |
| F then 0 | Duplex Operation with two transceivers ON/OFF |
| F then VFO | CALL Channel ON/OFF |
| F then SCAN | Exchange the MAIN band and SUB band data |

Refer to the RC-10 Instruction Manual for other operations.

7-3. ACCESSORIES

■ MA-700 VHF/UHF DUAL BAND MOBILE ANTENNA (TM-731A/731E)



■ MC-55 MOBILE MICROPHONE (8-pin)

The MC-55 provides UP/DOWN switches, LED display for switching transmit or receive, adjustable microphone gain, automatic timeout circuit (approx. 5 minutes) and many other functions.

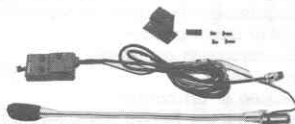

■ MC-85 MICROPHONE (8-pin)

The MC-85 is a unidirectional high-class electret condenser microphone provided with an output selector switch, audio level compensation circuit, low cut filter, level meter, PTT and LOCK switches.



■ MC-44/MC-44E (E: European Version) MULTI FUNCTION MICROPHONE



■ MC-60A MICROPHONE (8-pin)

The zinc die-cast base provides high stability. The MC-60A is complete with PTT and LOCK switches, UP/DOWN switches, impedance selector switch and a built-in pre-amplifier.



■ PG-2N DC POWER CABLE

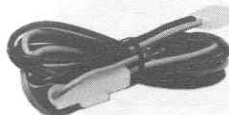

■ MC-44DM/44DME (E: European Version) MULTI FUNCTION MICROPHONE WITH AUTOPATCH



■ MC-80 MICROPHONE (8-pin)

The MC-80 is an omnidirectional electret condenser microphone that is provided with UP/DOWN switches, volume adjustment for output level, PTT and LOCK switches, and a built-in pre-amplifier.



■ PG-3B DC LINE NOISE FILTER

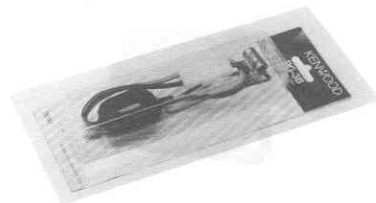

■ **PS-430 DC POWER SUPPLY**

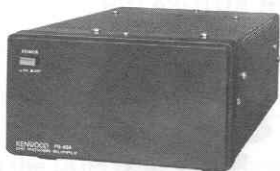

■ **PS-50 HEAVY DUTY DC POWER SUPPLY**

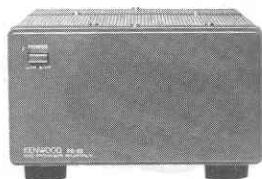

■ **MB-11 MOBILE MOUNTING BRACKET**

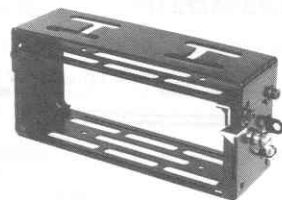

■ **SP-430 EXTERNAL SPEAKER**

The SP-430 is an attractive, compact external speaker. This low-distortion speaker provides clear reproduction of the high-quality audio obtained from the transceiver.



■ **SP-41 MOBILE SPEAKER (4 ohms)**



■ **CTCSS UNIT TSU-6**

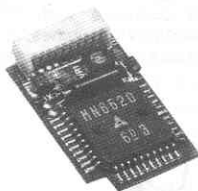

■ **SP-50B MOBILE SPEAKER (8 ohms)**

Compact and smart, high quality external speaker provides flexibility of installation for maximum convenience.



■ **RC-10 REMOTE CONTROLLER**

The RC-10 Remote Controller provides the following functions.

1. Direct entry of the desired Transmit/Receive Frequencies using the numeric keypad.
2. Transmit/Receive Frequency or Memory Channels up or down control.
3. 16-key autopatch operation.
4. Volume control
5. Squelch on or off control.
6. When connected to two transceivers allows duplex communications.

For additional information, please refer to the Instruction Manual provided with the RC-10.

