



KENWOOD

Operating Manual

Model **TS-700G**



Contents

Specifications		Page 3
Section 1	Features	Page 4
Section 2	Installation	Page 6
Section 3	Operating Controls	Page 8
Section 4	Operating Instructions	Page 12
Section 5	Circuit Description	Page 21
Section 6	Accessories	Page 23
Section 7	Alignment	Page 24
Section 8	Troubleshooting	Page 26

TS-700G SPECIFICATIONS

SPECIFICATIONS

TRANSMIT/RECEIVE FREQUENCY RANGE	144 ~ 146 MHz
MODE	SSB, FM, CW, AM
RF OUTPUT	10 watts for SSB, CW and FM 3 watts for AM
ANTENNA IMPEDANCE	50Ω (unbalanced)
CARRIER SUPPRESSION	Better than 40 dB
SIDE-BAND SUPPRESSION	Better than 40 dB
SPURIOUS RADIATION	Less than -60 dB
MAX. FREQUENCY DEVIATION (FM)	±5 kHz
REPEATER FREQUENCY SHIFT WIDTH	600 kHz
RPT TONE FREQUENCY	1750 Hz
MODULATION	Balanced modulation for SSB Variable reactance frequency shift for FM Low power modulation for AM
MICROPHONE	Dynamic microphone, 500Ω
AUDIO FREQUENCY RESPONSE	400 ~ 2600 Hz, within -9 dB
POWER CONSUMPTION	Transmit mode: 95W (AC 120/220V), 4A (DC 13.8V), max. Receive mode (no signal): 45W (AC 120/220V), 0.8A (DC 13.8V)
POWER REQUIREMENTS	AC 120/220V, 50/60 Hz DC 12V ~ 16V (13.8V as reference)
DIMENSIONS	278 (W) × 124 (H) × 320 (D) mm
WEIGHT	11 kg
RECEIVING SYSTEM	SSB, CW, AM: Single-superheterodyne FM: Double-superheterodyne
INTERMEDIATE FREQUENCY	SSB, CW, AM: 10.7 MHz FM: 1st IF ... 10.7 MHz 2nd IF ... 455 kHz
RECEIVING SENSITIVITY	SSB, CW: S/N = 10 dB or better at 0.25μV FM: S/N = 30 dB or better at 1μV 20 dB noise quieting = Less than 0.4μV AM: S/N = 10 dB or better at 1μV
IMAGE RATIO	Better than 60 dB
IF REJECTION	Better than 60 dB
PASS-BAND WIDTH	SSB, CW, AM: More than 2.4 kHz at -6 dB FM: More than 12 kHz at -6 dB
RECEIVER SELECTIVITY	SSB, CW, AM: Less than 4.8 kHz at -60 dB FM: Less than 24 kHz at -60 dB
SQUELCH SENSITIVITY	0.25μV
AUDIO OUTPUT	More than 2W at 8Ω load (10% distortion)
RECEIVER LOAD IMPEDANCE	8Ω
FREQUENCY STABILITY	Within ±2 kHz during one hour after one minute of warm-up, and within 150 Hz during any 30 minute period thereafter.

The above specifications are subject to change without notice for improvement.

SECTION 1. TS-700G FEATURES

1. The Model TS700G is a fully solid-state, all-mode amateur band transceiver designed to provide high quality communications on SSB, FM, AM and CW bands.
2. Basically engineered for fixed station operation but is also used for mobile station operation because of the employment of AC/DC two-way power system.
3. The single and doubleconversion type transceiver incorporates its own built-in VFO that continuously covers the frequency range of 144.00 to 146.00MHz in 2 bands. Repeater operation is also possible in the 145MHz. The repeater frequency is shifted at both NORMAL and REVERSE positions of the repeater knob.
4. A newly developed two-speed dial mechanism facilitates tuning: MAIN TUNING knob (inner) for closer tuning covers a change of 25kHz by one complete rotation, and QUICK TUNING knob (outer) covers a change of 100kHz similarly. You can tune in quickly with pin-point accuracy. This feature is very useful in receiving SSB signals.
5. The main dial is graduated at 1kHz intervals and provides accurate readings up to 100kHz, while the sub-dial is graduated at 50 and 100kHz intervals for reading frequencies up to 1MHz per rotation.
6. A total of 22 fixed channels (11 channels for each band) for all-mode operation including repeater operation. All the necessary crystal oscillator elements are available as optional accessories. Each of working channels can be visually checked by the KENWOOD's unique channel indicator.
7. A noise blanker (NB) circuit of the type normally found in many other HF products of our make is included to eliminate pulse noise such as ignition noise.
8. For improved FM-mode operation, a squelch circuit combined with a noise detector circuit and Schmidt circuit is added to the FM unit.
9. A tuner which uses a voltage variable capacitor is built in the receiver RF stage to minimize cross-talk and spurious interference, and a high "Q" tuning circuit in the antenna input stage for excellent selectivity.
10. A balanced-type mixer circuit based on the use of field effect transistors (FET) is adopted for the pre-mixer and heterodyne mixer to assure improved rejection of spurious signals during transmission.
11. By using the REPEATER knob, either the transmit or the receive frequency can be shifted down by 600kHz; at the NORMAL position of the knob, the transmit frequency is 600kHz below the dial frequency, and at the REVERSE position, the receive frequency is 600kHz below the dial frequency.
12. The IF stage includes a 6-element crystal filter during SSB reception, and the built-in wide and narrow band ceramic filters provide outstanding selectivity during FM reception.
13. The employment of threshold type RF gain control assures excellent S/N ratio at all times during reception of SSB signals.
14. Speaker output is free from distortion because of the use of amplification type AGC circuit. Signals transmitted are accompanied by little or no splutter and free from distortion thanks to the adoption of ALC circuit. The AGC circuit comprises such time-constant element that this constant is "slow" in SSB mode but "fast" in FM, AM or CW mode.
15. The built-in marker signal circuit enables you to calibrate the tuning dial precisely at 100kHz intervals. By setting the CALIBRATE switch to ON, the receiver RF input circuit is disabled, thus permitting frequency calibration without being disturbed by external signals.

16. The unique "S" meter provides accurate reading without causing "scale-out" even when unusually strong FM signal comes in. By manipulating the center meter switch, this meter functions as a center meter (tuning meter) for pin-point tuning of FM stations.
17. Turn the TONE switch upward operates a tone oscillator at 1750Hz, and at the same time, a repeater call signal is automatically transmitted.
18. The ON AIR lamp lights up when the transceiver shifts into transmitting state.
19. The built-in RIT circuit is very useful during reception, particularly in SSB and CW modes. It is designed to be used for both VFO and fixed channel operations.
20. Besides the built-in oval speaker (9cm by 6cm), an external speaker can be used by connecting it to the speaker terminal provided on the transceiver.
21. The transceiver operates on AC 120/220V or on DC 13.8V. It includes DC voltage multiplier of our own development, contributing much to the space-saving design of the model.
22. Significant improvements are embodied in the panel design for making this transceiver much easier to control and use. Dials and knobs are of more advanced type in visual and functional senses. Meter illumination and pilot lighting are included assuming nighttime use of the transceiver.
23. Visual aspects are taken as an important criterion in the designing of this transceiver. Mechanical features too have been treated similarly, with particular emphasis on their reliability.
24. For assuring easier access to the internals, the transceiver enclosure or case is in two parts, complete with special mechanical details to allow the front control panel to be detached. The final unit is also arranged so that it can be removed from the rear panel.
25. A carrying strap is provided for convenience of carrying the transceiver.
26. A high quality microphone is included among the standard accessories.
27. VOX operation is also available. The transceiver has provision for connection of VOX-3 obtained from KENWOOD as optional accessory.

SECTION 2. INSTALLATION

2-1. ACCESSORIES

The Model TS-700G transceiver is supplied with the following accessories. After unpacking, check the accessories against the list:

Operating manual	1
RCA plug connector.....	2
Feet with screws	2
Fuse: 1A (AC 220V).....	1
2A (AC 120V).....	1
2A (DC 20V).....	1
5A (DC cord).....	1
Microphone with hook, 500 ohm	1
AC power cord with connector.....	1
DC power cord with connector.....	1
VOX plug (installed).....	1
Speaker plug	1

2-2. OPERATING LOCATION

As with any solid-state electronic equipment, the place of use must be discriminated with the TS-700G, in order to avoid subjecting to extremes of ambient conditions.

A well-ventilated, dry place, where the transceiver will not be exposed to direct sunlight, should be selected. The TS-700G has a heat sink in its rear panel; be sure to install the transceiver so that there is a proper clearance at the rear and bottom. For better heat dissipation, keep it away from a wall. This precaution also applies when the transceiver is operated on the companion's seat in a car.

When you wish to use the transceiver in a car, you may put it on the seat but sure to secure some heat dissipating clearance under and behind it and to make proper provisions for protecting it against shocks.

2-3. POWER SUPPLY CONNECTION

The TS-700G is designed to operated on AC 120/220 V or DC 13.8 V. Switching between AC and DC is accomplished by replacing the power cord. The DC power cord is color coded (red for "+" and black for "-"). When connecting power cord, be sure to observe the following points:

1. Turn off the power switch and set the standby switch to REC position.
2. When replacing power cord, disconnect it from the AC socket (or battery). Care should be used to prevent electrical shocks when connecting the AC power cord. Each power cord is equipped with a 4-P plug complete with a stopper. When inserting the plug to the transceiver, be sure to press down the stopper with your finger and engage it into the latch on the transceiver side.

To pull the cord off the transceiver, push down the stopper to disengage it from the latch and then give a pull to the cord end. (See Fig. 1)

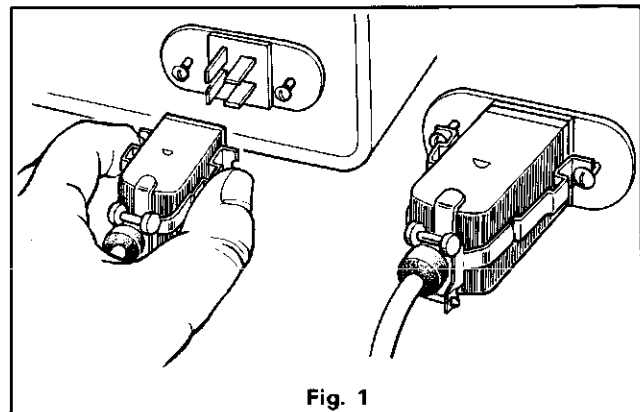

Fig. 1

2-4. ANTENNA CONNECTION

To ensure maximum enjoyment of QSO, the use of a good antenna is important. A standard ground-plane antenna or a Yagi antenna will give you best results. This antenna should be set up about 10 to 20 meters high and a coaxial cable connected to the antenna terminal of your transceiver.

When communicating with a far-away station or with a particular station, the use of a high gain, directional Yagi antenna is recommended. For local communications, use a non-directional antenna.

2-5. MICROPHONE

The microphone supplied with this transceiver is a 500-ohm impedance one designed specially for radio equipment of this class. Any other microphone may be used provided that its type and characteristic are suited to the transceiver. The optimum impedance of a microphone is anywhere between 500 and 600 ohms. For connection of microphone, refer to Fig. 2 and Fig. 3.

2-6. SENDING KEY

For CW operation, connect a sending key device to the KEY jack at the rear of the transceiver. CW mode is defeated by manipulating the mode switch, allowing you to operate in SSB, AM or FM mode.

2-7. EXTERNAL SPEAKER

A small sized speaker is built in TS-700G. If you wish to use an external speaker, connect it to the EXT SP jack at the rear of the transceiver by using the supplied speaker plug.

It is recommended that a speaker rated at 8 ohms of impedance and whose low and high ranges are sharply cut off be used for this purpose. Plugging in an external speaker cord will automatically cut the built-in speaker out of service.

When connecting an external speaker, be careful not to short the AF output and try to minimize the length of the cord, which should preferably be of shielded type, so as to prevent radio-frequency energy from reaching the speaker through the ground.

2-8. VOX CONNECTION

Your TS-700G can also be used for VOX operation in SSB or FM mode by connecting VOX-3 (option) to the 9-pin socket on the rear panel. For VOX operation, refer to the sub-paragraph 4-10 "VOX Operation".

When VOX-3 is not connected, be sure to insert the 9-pin plug provided into the VOX socket; otherwise, the transceiver cannot be set in the transmitting mode.

2-9. MIC HOOK

Attach a microphone hook to the case following the instructions give in fig. 4. The hook is furnished with the equipment.

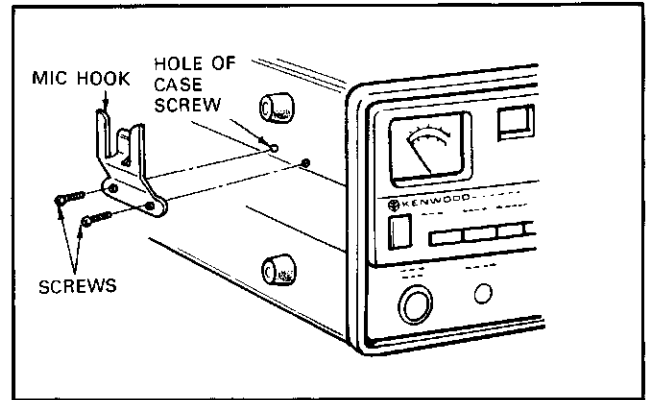

Fig. 4 Mounting of Microphone Hook

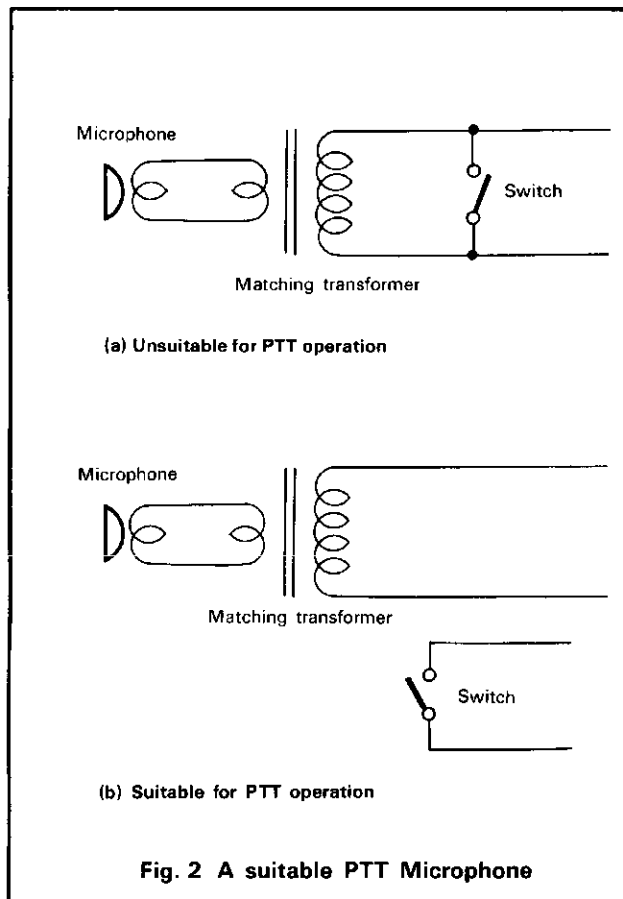

Fig. 2 A suitable PTT Microphone

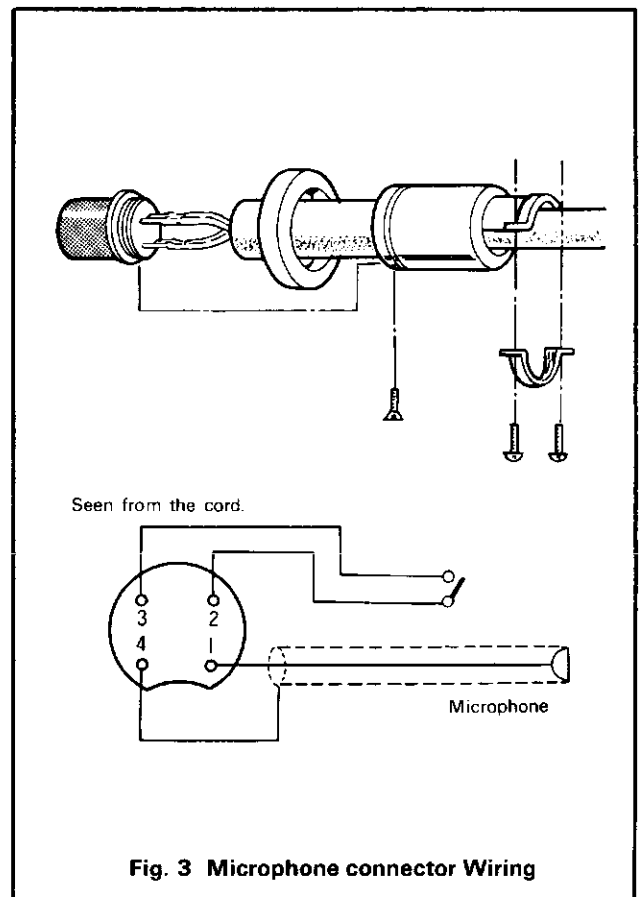
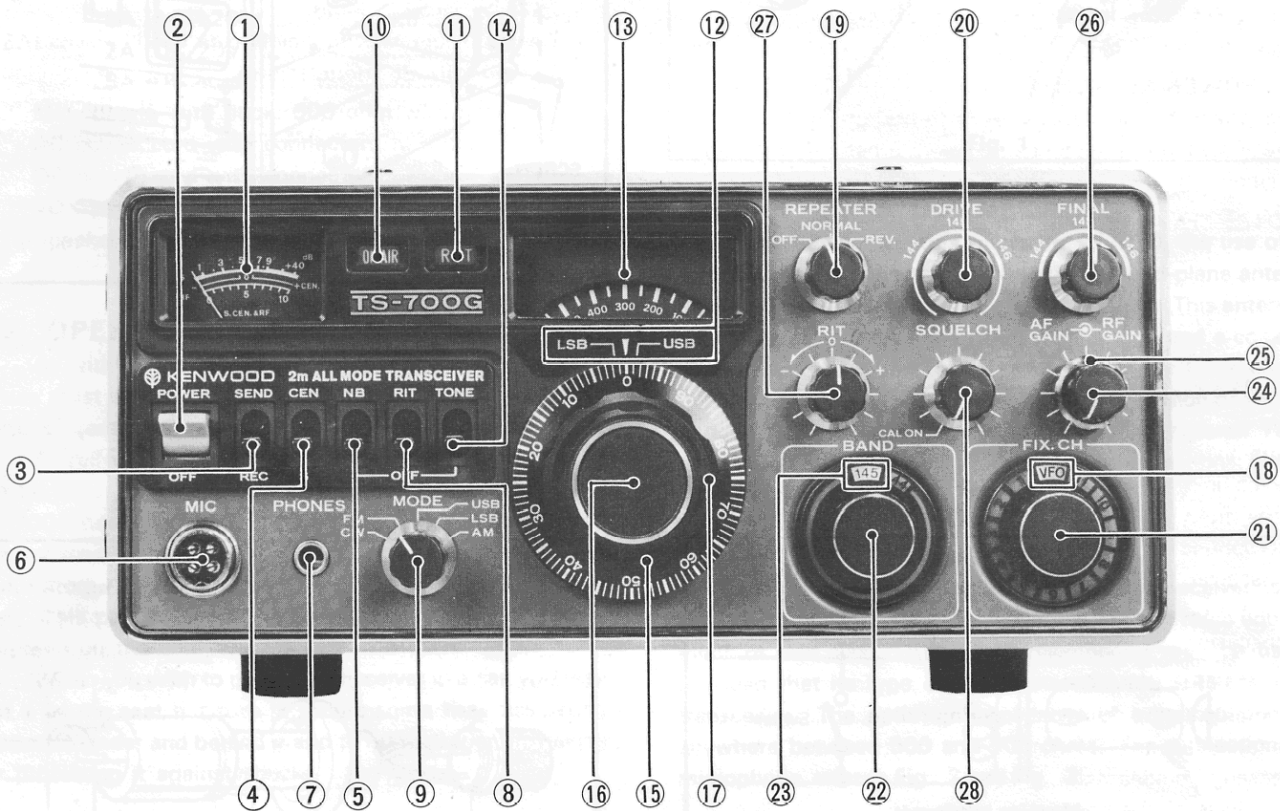

Fig. 3 Microphone connector Wiring

SECTION 3. OPERATING CONTROLS



3-1. Front Panel Controls

① METER

This meter has three functions. During reception, it serves as an "S" meter indicating the strength of received signal on a scale graduated from 1 to 9, 9+ 20dB and 9 + 40dB. During transmission, the meter indicates the strength of RF output signal.

The meter also functions as a center meter (Tuning meter) during FM reception when the METER switch is set to the CEN position.

② POWER SWITCH

The power to the transceiver is turned on by flipping the power switch to the up position, and turned off at the down position.

NOTE: The pilot lamps on the panel will light up with some time lag when the power switch is turned on. This time lag is due to the AVR action of the lamp circuit, and is in no way an indication of fault of the transceiver.

③ STANDBY SWITCH

This is a 2-position switch the SEND position is for transmission and the REC position for reception. With the switch in the REC position, the transceiver automatically shifts from receiving mode to transmitting mode if the microphone PTT switch is set to ON. Do not leave the transceiver in transmitting mode when the transmitting circuit is out of adjustment, as it may result in damage to the transceiver.

④ METER SWITCH

By manipulating this switch during FM reception, the meter functions as an "S" meter or a center meter. In other receiving modes, the meter functions as "S" meter regardless of the position of the switch.

⑤ NB (noise blanker) Switch

Turning on this switch will suppress pulse type noises due to ignition systems of nearby cars. Noiseless audio output can be obtained even when receiving signals are weak.

⑥ MICROPHONE JACK

For connection of microphone. This jack has terminals for both microphone input and PTT circuit.

⑦ PHONES JACK

For connection of headphone with impedance of 8 to 16 ohms. Plugging the headphone will shut off the speaker.

⑧ RIT SWITCH

For on-off control of the RIT (receiver incremental tuning) circuit.

⑨ MODE SWITCH

By using this switch, any of the following five modes can be selected:

CW (sending key):

Morse-code telegraphic communications (A1)

FM (frequency modulation):

Communications with FM waves (F3)

USB (upper side band):

Communications with "upper side band" waves. For operation in 144 MHz 2-meter band, the international practice calls for the use of USB (A3J).

LSB (lower side band):

Communications with "lower side band" waves (A3J).

AM (amplitude modulation):

Communications with AM waves (A3). Reception of LSB or USB signals in AM mode results in unintelligible wow-like audio output.

⑩ ON AIR INDICATOR

This lamp keeps lighting while the transceiver is in transmitting mode.

⑪ RIT INDICATOR

This lamp remains on to indicate that the RIT circuit is operating.

⑫ DIAL GAUGE

This is used as a reference for reading frequencies on the main dial.

⑬ SUB-DIAL

The dial scale is graduated from 0 to 1000, covering a width of 1 MHz. Each graduated interval is 50 kHz. The scale disc rotates in the same direction as the MAIN TUNING knob and COARSE TUNING knob are turned. The rotation ratio of two knobs is such that the whole 0-1000 range is covered when the MAIN knob is rotated 40 times or when the COARSE knob is rotated 10 times.

⑭ TONE SWITCH

This switch is used to call in a repeater station. Turn the switch upward operates a tone oscillator at 1750Hz, and at the same time, a repeater call signal is automatically transmitted.

⑮ MAIN DIAL

This dial scale is graduated at 1 kHz intervals.

⑯ MAIN TUNING KNOB (inner)

For setting the transceiver to the desired operating frequency. One rotation of this knob changes the frequency by 25 kHz.

⑰ COARSE TUNING KNOB

Another name of this knob is the "fast-change" tuning knob. The gear ratio in the mechanical link between this knob and VFO is so small that you can quickly locate your desired frequency. One rotation of the knob corresponds to a change of 100 kHz.

⑱ Channel Indicator

This lamp indicator comes on when VFO or a fixed channel oscillator is in operation. During fixed channel operation, this indicator instantly tells whether your desired channel is loaded with a crystal oscillator element.

⑲ REPEATER KNOB

The REPEATER knob functions only in 145MHz band, and is used to select simplex operation and repeater operation. In 144MHz band, the transmitter is always set in the simplex operation mode regardless of the position of the REPEATER knob.

⑳ DRIVE KNOB

For tuning the RF driver and MIX input coil for best reception and the output circuit of the HET mixer for best transmission. This control adjusts the electronic tuning circuit designed for simultaneous tuning in transmit-receive operation.

㉑ FIX CH SWITCH

For selecting VFO and fixed channels. There are 11 fixed channels in each band (a total of 22 channels in 2 bands). The fractions of oscillating frequencies of the crystal elements in these 2 bands remain the same: for instance, the operating frequency of 144.48 MHz in the 144 MHz band changes to 145.48MHz in the 145MHz bands. The fixed channels can also be used for repeater operation.

㉒ BAND SWITCH

For selecting the frequency band at which the transceiver is to be operated. Two selective bands, 1MHz wide, are provided for all amateur bands in the range from 144MHz to 146MHz.

㉓ BAND INDICATOR

Indicates the frequency band of 144MHz, 145MHz at which the transceiver is operated.

㉔ AF GAIN KNOB (INNER)

This adjusts the gain of the receiving audio amplifier. A clockwise turn of the knob will increase the audio output.

㉕ RF GAIN KNOB (OUTER)

For adjusting the gain of the RF amplifier in the receiver section. With this control turned to extreme clockwise position, the gain is maximized, and vice versa. The "S" meter indicates the gain set by this control. If the pointer of the "S" Meter is at "9", then radio waves of lower than "9" level will be attenuated. This feature emphasizes the wanted signal and suppresses the unwanted signal to produce a clear output. The RF gain can be directly read on the "S" meter.

㉖ FINAL KNOB

The antenna side BPF is tuned by this knob. It provides a very effective control in minimizing the spurious component during transmission and avoiding undesirable modulation due to interfering signals during reception.

㉗ RIT KNOB

This knob is used to fine adjust the receiving frequency when the RIT circuit is ON.

It adjusts the receive frequency without changing the transmit frequency. Here's how to use this control: index the pointer of this control to RIT "O" on the panel face. This will introduce coincidence between transmit frequency and receive frequency. Check the frequency of the other party- if the checked frequency is deviated from yours, shift the receive frequency (without regard to transmit frequency) by about ± 2 kHz to match it to that of the other party. The RIT circuit is operative even when VFO or any of the fixed oscillator channels is in service.

㉘ SQUELCH CAL Knob

Turning this knob clockwise during FM mode of operation will set SQUELCH to ON. This knob is normally turned clockwise so that the internally induced noise can be eliminated. When the knob is turned fully counter-clockwise during reception, the CAL switch is activated to energize the marker oscillator, allowing calibration of the receive frequency at 100 kHz intervals.

Note: The transceiver stops operating when the CAL switch is ON.

When receiving a marker signal with the CAL switch set to ON, do not turn the FINAL knob as it will cause the marker level (marker signal level) to be deviated. In this case, set the FINAL knob to the receive frequency.

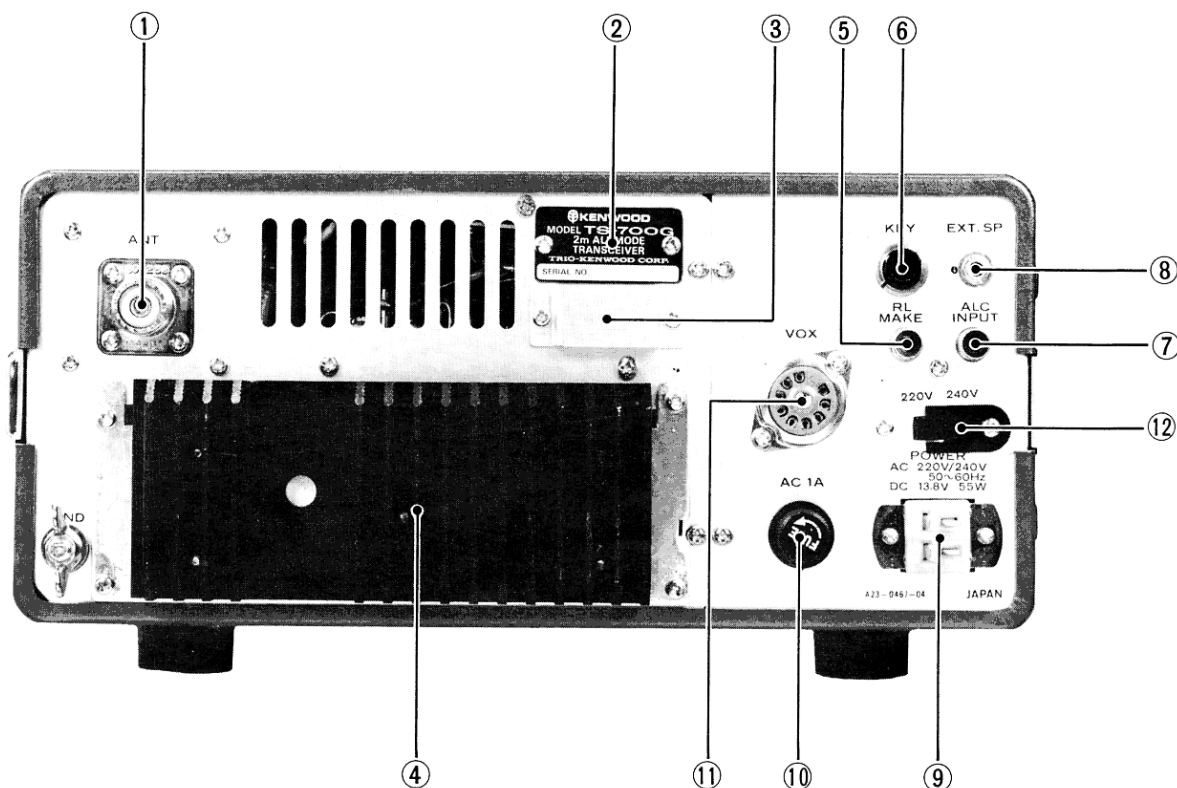

3-2. Rear Panel Controls

① ANT Terminal

For connection of antenna.

② NAME PLATE

TS-700G serial number is marked on this plate.

③ TRANSISTOR PROTECTIVE COVER

The transistors in the AVR circuit for 11V and 20V lines are protected by this cover. The cover also functions as a heat sink for the transistors.

④ HEAT SINK (FOR TRANSMITTER FINAL STAGE)

For protection of transistors from overheating.

⑤ RL-MAKE TERMINAL (RELAY TERMINAL)

This terminal should be OFF during reception, and should be grounded during transmission.

⑥ KEY JACK

This jack is used for operating the transceiver in CW mode. Connect an external telegraphic key device.

⑦ ALC-INPUT TERMINAL

External ALC terminal.

⑧ EXT SP TERMINAL

For connection of an external speaker.

⑨ POWER CORD JACK

For connection of the supplied AC power cord (or DC power cord).

⑩ AC FUSE HOLDER

For AC power fuse (primary). When the position of the ⑫ AC POWER SELECT SWITCH is changed, it is also necessary to change the power fuse. For 120 volt operation a 2 ampere fuse, for 220V operation a 1 ampere fuse provided with the TS-700G should be used.

⑪ VOX SOCKET

For connection of a voice control unit. When VOX unit is not connected, be sure to insert the 9-pin MT plug into the socket.

Failure to observe this precaution will cause the standby relay to be inoperative and thus the transceiver cannot be set in the transmitting mode- also, the RF input circuit cannot be turned off at the ON position of the CAL switch.

⑫ AC POWER SELECT SWITCH

Set this switch to your local AC voltage, 120V or 220V. When the setting position of the switch is to be changed, make sure to replace the fuse with a proper type fuse. (120V → 2A, 220V → 1A)

Note: Always disconnected power supply before setting the switch.

SECTION 4. OPERATING INSTRUCTIONS

4-1. RECEPTION

After connecting the power cord, antenna, microphone, key device, etc., set controls and knobs by following Table 1.

First, turn the POWER switch to ON. The pilot lamps in the meter, sub-dial pointer, band switch and FIX CH switch will all light up, indicating that the transceiver is ready for operation. Because of solid-state design, the transceiver can be put into operation immediately after the POWER switch is ON.

Next, adjust the controls and knobs according to Table 2.

Table 1. Front Panel

POWER Switch.....	OFF
Standby Switch.....	REC
METER Switch.....	S
NB Switch.....	OFF
RIT Switch.....	OFF
MODE Switch.....	CW, FM, USB, LSB, or AM
DRIVE Knob.....	Center position
FINAL Knob.....	Center position
RIT Knob.....	0
SQUELCH Knob.....	Fully counterclockwise (not CAL)
RF GAIN Knob.....	Fully clockwise
AF GAIN Knob.....	Fully counterclockwise
BAND Switch.....	Desired receiving band
FIX CH Switch.....	VFO
REPEATER Switch..	OFF
TONE Switch.....	OFF

The foregoing techniques are common to all modes of operation. Each mode, however, calls for special techniques of its own. Such special techniques will be discussed for each of the five modes.

CW Mode (How to use RIT)

With RIT switch turned off, position MAIN DIAL in such a way that the incoming CW signal will beat at 900 Hz (see Note 1). Under this condition, you can "zero in" your operating frequency to the frequency of incoming CW signal (see Note 2).

Similarly, if the other party calls back with 900 Hz beat tone in response to your call signal, it means that the transceiver of the other party is in "zero in" status. Should the other party call back with a beat tone off 900 Hz or should you want to communicate with a beat frequency of your choice, turn on RIT switch and adjust RIT knob to obtain the desired beat.

Table 2

Controls and Knobs	Adjustment and Setting
AF GAIN	* Turn clockwise for suitable volume.
MODE (CW, FM, USB, LSB, AM)	* Set at the desired mode.
MAIN TUNING Knob	* Turn slowly and set for clearest signal.
DRIVE (use band marks as easy guide.)	* Adjust for maximum sensitivity.
FINAL	* Adjust for maximum sensitivity.
RF GAIN	* Normally, this knob is set at the extreme clockwise position. When the signal is very strong, turn it counterclockwise for suitable gain.
SQUELCH	* This is used for FM mode of operation. Turn the knob clockwise so that noise at no-signal time disappears. This knob is normally set at a position where noise just disappears.
RIT	* With the RIT switch ON, turn the knob in either direction and only the receive frequency will be varied. Refer to paragraph "How to Use RIT".

FM Mode

Set the MAIN dial for optimum reception. By setting the METER switch to the CEN position, the meter functions as a center meter (center frequency indicated). Turn the MAIN dial so that the center meter indicates "0" while receiving the other party's signal. In this way, the transmit frequency will coincide with the receive frequency.

Next, set the METER switch to the S position and the meter will indicate the strength of the incoming signal. If, in this case, the meter pointer fluctuates in response to the sound in the speaker, turn the MAIN dial a little (a few kHz) in either direction until the meter indication is stabilized (meter is stabilized if no fading exists).

Since the TS-700G is so designed that the IF circuit for SSB forms a part of the "S" meter indication circuit for FM, the "S" provides logarithmic indications for FM waves and is free from saturation even when the input signal strength is very high, thus eliminating the need for calibration for each mode of operation.

Since the IF band is wide in FM mode, a slight deviation of frequency does not affect the reception. In transmitting operation, however, the other party could be using a fixed channel. Because of this possibility, it is advisable that you "zero in" your frequency to that of the other party by properly setting the MAIN dial in such a way that the center meter indicates the "O" zone.

If the "S" meter continues to fluctuate or if satisfactory audio output is not available, it is very likely that the other party is sending the message on SSB. You can easily check this by turning the MODE switch to USB or LSB position.

SSB Mode

Of the single sideband mode, USB is traditionally more often used than LSB. As far as the operating technique is concerned, there is no difference between two.

Generally, the "zero in" technique in SSB mode requires a little experience.

A. Discrimination between SSB and FM

(1) Use of "S" Meter

If the "S" meter indication is steady (meter pointer almost stops), the incoming signal is FM; otherwise, it is SSB.

(2) Use of MODE Switch

If a clear signal is heard at the FM position of the MODE switch, the signal is FM. The sound in SSB mode is not heard at this position of the switch

(3) Use of Beat Noise

In FM mode, a beat noise will be heard between the words of signals being received. In SSB mode, no beat noise is heard.

Note: In the case of AM waves, a beat noise will be heard during non-modulation time even in SSB mode.

B. Dial Setting

When the receiving signal is found to be SSB by the above method A, in USB first set the MAIN dial a few kHz below the receiving frequency (turn the dial 2 or 3 divisions counterclockwise). You will hear a high pitch sound such as is heard from a magnetic recording tape set in the fast-forward mode. Turn the dial clockwise for higher frequency and the sound will become clearer. Set the dial at the position where the sound is heard most clearly (this is the "zero in" point).

Note: 1 The "zero in" point can be easily located because the sound loses its clarity suddenly when the dial passes away from the "zero in" point.

If a clear sound cannot be heard even by following the above procedure, it may be an indication that the signal is LSB. Set the MODE switch to LSB position. In this case, the method of setting the MAIN dial should be performed in reverse order.

Note: 1. If the frequency of the other party is deviated after the "zero in" point has been obtained, set the RIT switch to ON and adjust the RIT knob.

2. When the RIT feature is used, the receiving frequency will be deviated from the transmitting frequency. Therefore, the RIT knob must be set to "O" or the RIT switch to OFF before you start to transmit again.

AM Mode

AM waves cannot be demodulated in FM mode; also, they will be heard as a continuous beat noise in SSB mode. Optimum reception of AM signal is secured by tuning the transceiver in such a way as to maximize the deflection of the "S" meter pointer. Since the bandwidth of the receiver crystal filter is somewhat narrow because this filter is primarily for SSB reception, the sound output of the speaker may have its high pitch components suppressed and hence lack clarity. This can be remedied by shifting the receive frequency a little by using the RIT knob. The same effect can be produced by means of the MAIN dial but the use of this dial for that purpose is not recommendable because, should you do so, you will not be able to "zero in" your transmit frequency to the frequency of the other party.

Where your transceiver and that of the other party are both TS-700G (TS-700), it should be noted that, in AM mode, the transmit carrier frequency is 10.7006 MHz which is higher than the receive carrier frequency by 600 Hz.

Accordingly, you first "zero in" your frequency to that of the other party by adjusting your MAIN dial and send out the signal, to which the other party will respond after possibly changing his frequency. If he should do so, the pointer of your "S" meter then would deflect down from the initial maximum level indication; this drop must not be interpreted as a sign of trouble. In such a case, you are expected to re-match your frequency to the new incoming frequency by using your RIT knob with the RIT switch set to ON (refer to Fig 5 on page 14.)

4-2. TRANSMISSION

Before transmitting, perform all the necessary procedures for optimum reception. Make sure that the radio waves you have selected does not interfere with other radio stations.

Adjust the controls and knobs (DRIVE knob, FINAL knob, microphone VR, etc.) for transmission of good quality signals. Connect a 50-ohm dummy load or antenna to the transceiver before starting to adjust the various controls. The use of dummy load is recommended because this prevents the emission of disturbing signals. Use the dummy load, which is sized to dissipate about 20 watts of transmitter power. The tuning procedure should be completed within the least time possible from the viewpoint of the life of the transceiver. Set the controls and knobs as shown in Table 3 below.

Table 3. Initial settings of control on front panel

Standby Switch.....	REC
RIT Switch.....	OFF
MODE Switch.....	CW
RF GAIN Knob.....	Fully clockwise
DRIVE Knob.....	144
FINAL Knob.....	144
RIT Knob.....	0
AF GAIN Knob.....	Set for proper volume on reception
SQUELCH Knob.....	Set for optimum squelch effect (do not set CAL to ON)
BAND Switch.....	144
FIX CH Switch.....	VFO
REPEATER Switch..	OFF

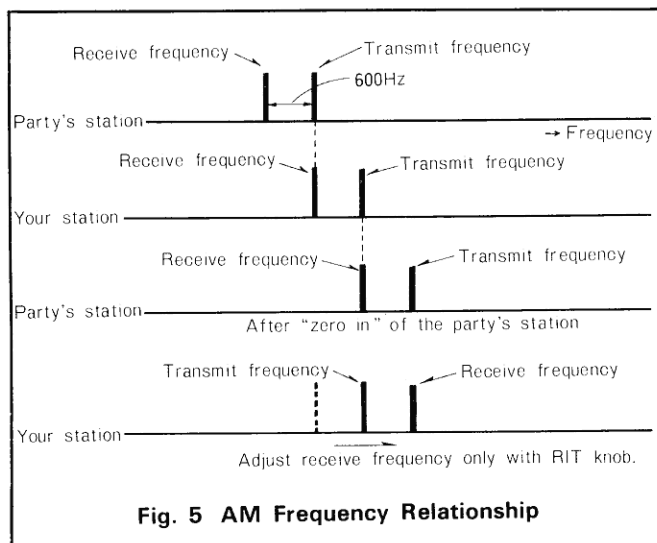

CW Mode

Turn BAND switch to your desired frequency (144—146 MHz). After turning MODE switch to CW position, shift STANDBY switch from REC to SEND position just to make sure that the meter pointer deflects and ON AIR lamp lights up, and then move back this switch to REC position.

Under this condition, move STANDBY switch to SEND side and rotate DRIVE knob for maximum deflection of the meter pointer deflection further. Repeat this manner a few times.

The foregoing procedure should be carried out rapidly, without unnecessary long delay at each step. If the telegraphic key device has already been connected to the transceiver during adjustments, the device should be set in the "key-down" condition. Having adjusted the transceiver as above, you are now ready to use the key for CW communication.

Other Modes

When the transceiver is properly adjusted for operation in CW mode, it is ready for use in other modes (FM, LSB, USB and AM). Connect the microphone and speak after shifting the STANDBY switch to SEND position. Your voice will now be transmitted.

Microphone gain adjustment for FM and SSB (USB, LSB) can be made by the gain adjusters which become accessible when the top lid of the transceiver case is removed. The optimum setting position of these adjusters is about the midway position of their turning range (see Fig. 8). The microphone gain should preferably be reduced as small as possible to assure good quality of transmission. In AM mode, optimum output can be obtained by adjusting the AM CAR knob (see Fig. 8) inside the transceiver until the meter indicates anywhere between "3" and "5".

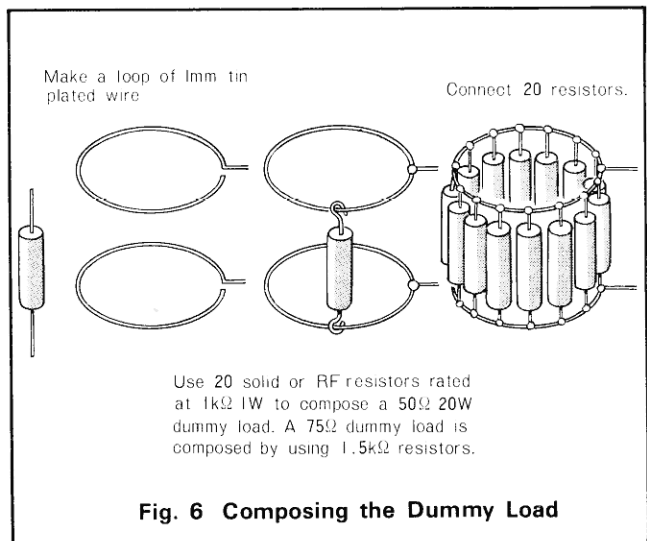

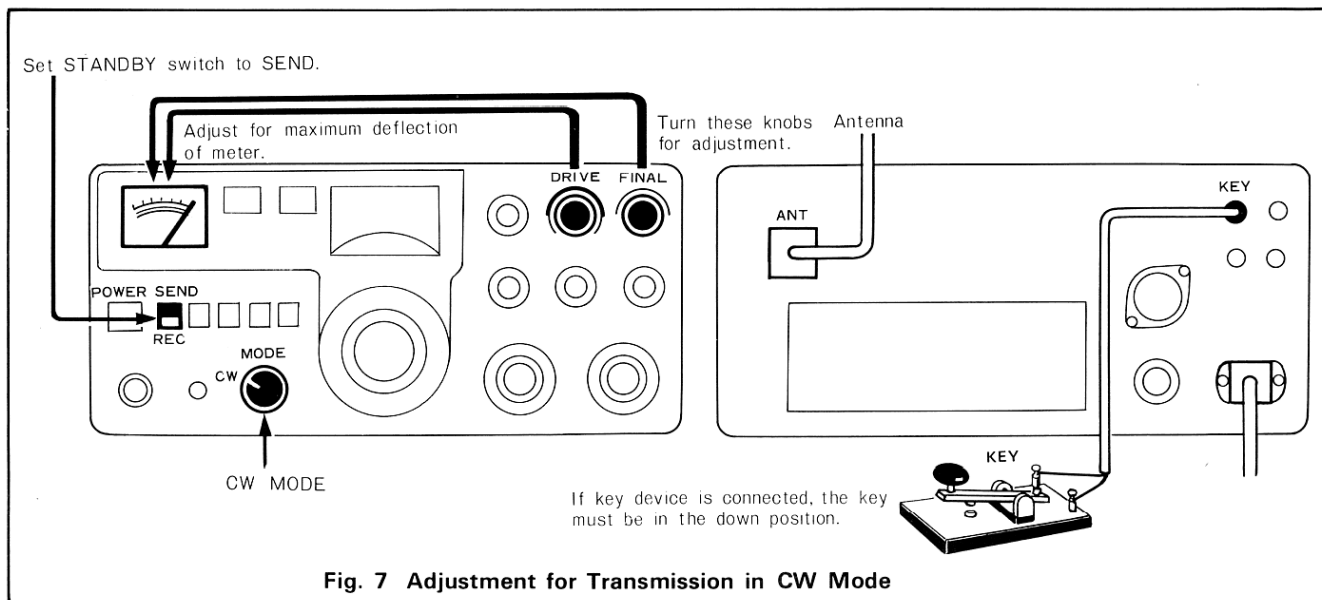

PTT (push-to-talk) Operation

By connecting the supplied microphone or any other microphone equipped with PTT switch (KENWOOD's MC-50, etc.), the transceiver is readily used for PTT operation. For communication, depress PTT switch with STANDBY switch left in the REC position.

4-3. FREQUENCY CALIBRATION (Fig. 9)

To read correct frequencies, the MAIN dial must be calibrated previously by using the 100 kHz marker unit built in the transceiver. The marker unit is operative when SQUELCH knob is turned fully counterclockwise and CAL switch is set to ON. During the operation of the marker unit, the higher harmonics can be received over the entire band exactly at 100 kHz intervals. In this instance, the RF input circuit (relay) is deenergized and, therefore, external waves are scarcely received.

Frequency Calibration for USB

By rotating MAIN TUNING knob clockwise the beat tone of the marker unit changes from high to low pitch and finally disappears at zero-beat position. Hold the MAIN TUNING knob at this position, and displace the MAIN dial to bring the "0" graduation mark to the USB dial gauge (see Fig. 9-a).

Note: The MAIN dial scale and its knob are held together by means of a spring and normally move together, but one can be displaced relative to the other by overcoming the friction due to the spring force when the knob is pressed lightly and turned.

Frequency Calibration for LSB

The method for LSB is similar to the above method for USB, the difference being that the knob is to be turned counterclockwise for "zero-beat". Match the "0" mark on the MAIN dial to the LSB dial gauge (see Fig. 9-b).

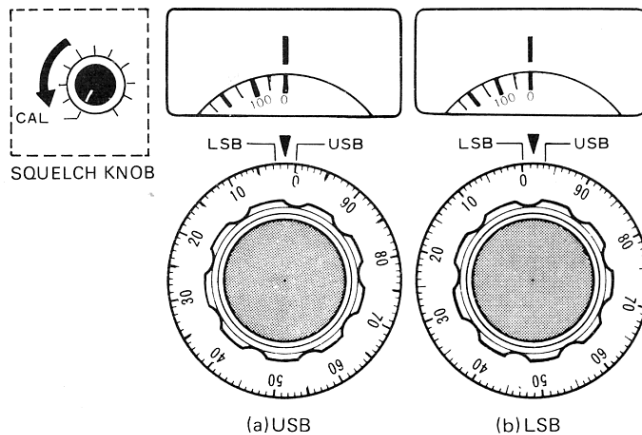
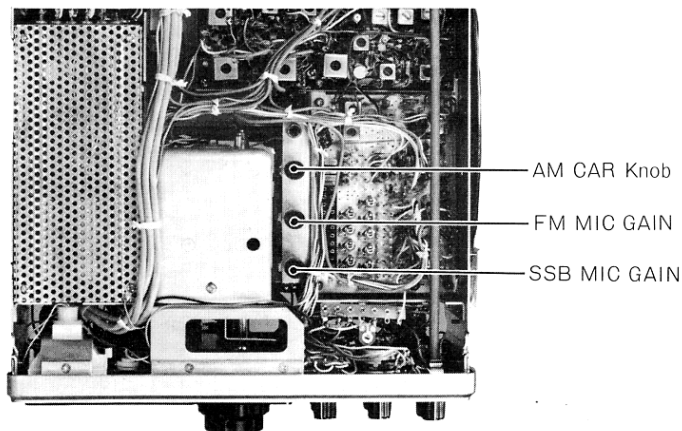

Note: Calibration for both USB and LSB is unnecessary; when the dial is calibrated for either one, it will automatically cover the other one.

Frequency Calibration for CW

The transmit frequency for this mode is about 900 Hz below that for the calibrated position for LSB. For calibration, simply set the "0" mark on MAIN dial against the triangle mark "▼" at the center of the dial gauge after calibrating according to the above method.

Frequency Calibration for FM and AM

Beating by the marker signal in the manner mentioned above does not occur in this calibration. The exact tuning point is obtained where the meter exhibits a maximum deflection by a carrier frequency. In calibrating for FM, use the marker signal. The position at which the center meter indicates the "0" position is where the FM frequency is tuned correctly. Set the MAIN dial against the center position of the dial gauge as in the case of CW.

4-4. READING THE FREQUENCIES

Refer to Fig. 10. Approximate frequency can be read only on the sub-dial; however, the MAIN dial and dial gauges should be used if accurate reading on the order of 1 kHz is required.

When your transceiver is to be operated on CW mode, vary the beat frequency by turning the MAIN TUNING knob from higher side to lower side (counterclockwise rotation) while receiving the desired signal from the other party. Reduce the beat to zero by so turning the knob, and then rotate the knob upward (clockwise rotation) to obtain a beat frequency of about 900 Hz. Under this condition, read the frequency on the MAIN dial by referring to the triangle mark "▼". Note that a beat frequency is present on both sides of the "zero-beat" point; one is a strong main beat and the other is a weak residual beat. Be sure to go by the main beat in your tuning operation

Note: Tuning in the residual beat will result in failure of "zero in" to the frequency of the other party. The residual beat can be easily discriminated from the main beat because the "S" meter deflects little even when the residual beat is tuned in about 900 Hz.

4-5. OPERATION WITH FIXED CHANNEL

The Model TS-700G has built-in semi-synthesizer crystal oscillator circuit for use in fixed channel operation, which is of great advantage where the transceiver has to be operated frequently on certain frequencies. Examples of such a situation are: operation in frequently used FM mode, mobile operation in SSB, communications based on schedules of the other party, mobile operation in a vehicle, etc.

When FIX CH knob is switched from VFO to any of fixed channels, the channel indicator lamp lights up as long as the selected channel is loaded with a crystal. The FIX CH knob has a total of 11 fixed channel position; 1,2,3...11.

The oscillation frequency of fixed channel crystal can be obtained from the following formula:

Crystal Oscillator Frequency for FM, AM and CW

$$\text{Crystal oscillator frequency (MHz)} = X - (125.10 + 10.70)$$

$$X = \text{Desired operating frequency (MHz)}$$

$$125.10 \text{ (MHz)} = \text{Heterodyne frequency for 144 MHz band}$$

$$10.70 \text{ (MHz)} = \text{Transmitter IF frequency}$$

The TS-700G employs a MIX (synthesis) system. If crystals are arranged for 144 MHz band (144–145 MHz), they are also used for 145 MHz (145–146 MHz), bands by switching the BAND switch, where the three places of decimals of the "MHz" figure remains the same.

When crystals are arranged for 144.48 MHz, the frequencies obtained for each band are as follows:

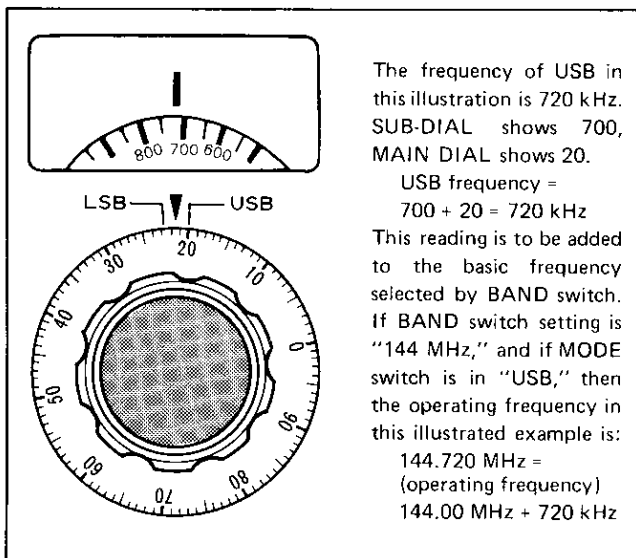

Fig. 10 Reading the Frequencies

144 MHz band

$144.48 - (125.10 + 10.70) = 8.68$ MHz (crystal oscillator frequency)

145 MHz band

$8.68 + (126.10 + 10.70) = 145.48$ MHz

126.10 MHz = HET (heterodyne) frequency for 145 MHz band

Note: The transmitter carrier oscillator gives an IF frequency of 10.7006 MHz in CW or AM mode. For practical purposes, the fractional 600 Hz is too small to require a correction by means of the crystals to be put in the fixed oscillator circuit, and should be no cause for correction.

Crystal Oscillator Frequency for SSB

In SSB mode, your operating frequency will deviate by 1.5 kHz from the center frequency of the filter if the frequency of the crystal in a fixed oscillator circuit happens to be equal to that of FM.

If you use the USB wave (which is dictated by the international amateur practice in 144 MHz band), select a crystal whose frequency is 1.5 kHz above that of FM. For LSB, however, the crystal frequency must be 1.5 kHz below that of FM.

When crystals are arranged for 144.250 MHz of USB, the crystal oscillator frequency is as follows:

$144.250 - (125.100 + 10.700) + 0.0015 = 8.4515$ MHz (crystal oscillator frequency)

0.0015 stands for 1.5 kHz.

Note: When the crystal oscillator frequency is 9.200MHz, the operating frequencies at 144MHz band is 145.000MHz and, therefore, cause no problems. However, if the same crystals are used for 145MHz band, the operating frequency is 146.000MHz; care should be used not to transmit with this 146MHz frequency. Similarly, if the oscillator frequency is 8.200MHz the operating frequency is 144.00MHz at 144MHz band; do not transmit with this 144MHz frequency.

4-6. HOW TO USE RIT

The term "RIT" is a simplified expression of Receiver Incremental Tuning. The RIT feature enables you to shift the receive frequency by about ± 2 kHz without changing the transmit frequency, adjusting the receive frequency to the deviated frequency of the other party.

Here is how to use RIT: Turn ON the RIT switch (RIT indicator lamp will light). Tune your receive frequency to that of the other party by adjusting the RIT knob.

The transceiver tuned this way is off the TRANSCERVE frequency (one and the same frequency for both transmission and reception). To call out the other party during two-way communication when your transceiver is tuned as above, you must turn OFF the RIT switch. The procedures for RIT operation for each mode are given in Paragraph 4-1 Reception.

- Note:**
1. RIT is effective also for fixed channel operation.
 2. If the RIT switch is ON in SSB mode and the transceiver is operated while you are not noticing the receive frequency is deviated by 1—2 kHz, you may not receive the signal of the other party.

4-7. MOBILE OPERATION WITH EXTERNAL DC POWER SUPPLY

The TS-700G operates also with DC 13.8V supplied from an external DC source, and is therefore adapted to duty on a vehicle.

Whether the TS-700G is used as a fixed station or as a mobile station, the techniques of operating it remain the same. A more enjoyable use is possible in mobile application provided that you device one or two provisions as to the place or manner of installation. The place of use depends on where the operator is seated.

If you are to operate your transceiver while driving the vehicle, then you should set up a proper mounting bracket right beside the driver's seat. You may locate the transceiver at the companion's seat provided that is secured firmly by means of seat belt or the like so that it is prevented from falling down.

Mobile Antenna

There are many types of mobile antenna for 144 MHz band use. Most of them will do but a 1/4 wavelength whip or ground-plane antenna, or a 5/8 wavelength antenna is preferred.

Power Capacity

The TS-700G draws about 4 amperes maximum when it is working with full power. This much current is easily supplied by any automobile battery. When the power is supplied from such a battery, it is recommended that the transceiver be operated while the automobile engine is in operation, in order to prevent over-discharge of the battery.

Note: For safe driving of automobile, it is preferable that the transceiver be operated on fixed channels (prepare necessary crystal oscillators).

4-8. REPEATER OPERATION

Operating Frequency

The 3-position REPEATER knob functions as follows:

* OFF Position

Both the transmit and receive frequencies are the same as indicated on the dial.

* NORMAL Position

The dial frequency indicates the receive frequency. The transmit frequency is 600 kHz below the receive frequency.

* REV Position

The dial frequency indicates the transmit frequency. The receive frequency is 600 kHz below the transmit frequency.

The relationship between the sub-dial and the transmit/receive frequencies is shown in Fig. 11.

Repeater Operation

The TS-700G is designed to operate with the repeater system of the following specifications:

Frequency shift: ± 600 kHz

Starting system: Carrier controlled type

Actuate by tone controlled (tone frequency 1750Hz)

The built-in tone oscillator operates at 1750Hz when the TONE SWITCH is moved up, and at the same time, a repeater call signal is automatically transmitted. Releasing the hand from the switch automatically stops the oscillator.

When the REPEATER knob is set to REVERSE, the receive frequency is 600kHz below the transmit frequency (dial frequency). At this position of the knob, the signal from the other station can be directly received if it is occupied by anyone, thus allowing you to check the band condition. If, at this time, the transceiver is set in transmitting mode and then the party using the repeater station responds to your signal, you can communicate directly with the party without having to use the repeater station. Thereafter change to simplex operation, the repeater station is released.

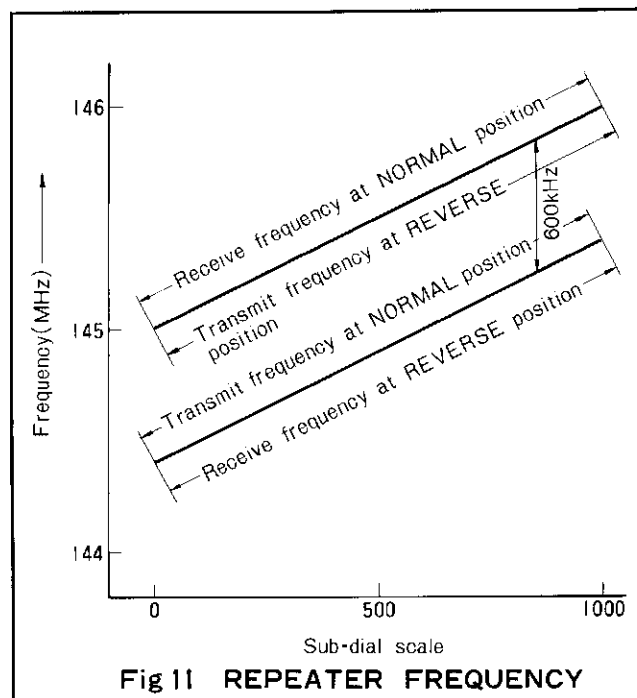

4-9. OSCAR (Artificial Satellite) OPERATION

At present, two amateur radio communication artificial satellites (No. 6 and No. 7) are travelling along the orbit of the earth. These satellites can also be used as your repeater stations. In repeater operation using such satellites, your TS-700G functions as a transmitter of 2m→10m "up-link" repeater frequency or as a receiver of 70 cm→2m "down-link" repeater frequency. The link frequencies in this operation are given in Table 4.

An example of 2m→10m repeater operation using TS-700G and R-599 of our make is shown in Fig. 12 for your reference.

Besides being used as shown in Fig. 12, the OSCAR satellites also provide you with various applications such as tracking of satellite orbit, use of beacon waves, etc., though you need special knowledge on the manner of operation, antenna installation and others which are somewhat different from those on the general amateur radio communication. With basic knowledge, you will be able to enjoy repeater communication through the amateur artificial satellites without difficulty. We suggest that you proceed with "on the air" by referring to guide books available.

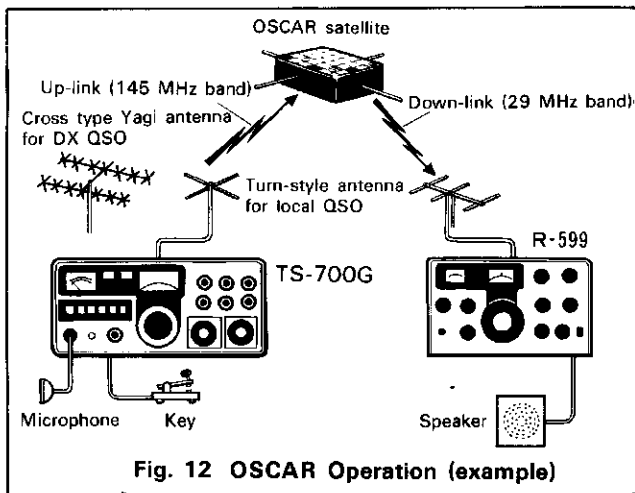

Fig. 12 OSCAR Operation (example)

Table 4

REPEATER		
OSCAR NO. 6	OSCAR NO. 7	
2 m → 10 m	70 cm → 2 m	2 m → 10 m
145.900 ~ 146.000 MHz ↓	432.125 ~ 432.175 MHz ↓	145.80 ~ 145.95 MHz ↓
29.450 ~ 29.550 MHz	145.975 ~ 145.925 MHz	29.40 ~ 29.50 MHz
BEACON		
435.100 MHz (300 mW) 29.450 MHz (200 mW)	29.502 MHz (200 mW) 145.975 MHz (200 mW) 435.10 MHz (300 ~ 400 mW)	

4-10. VOX OPERATION

For VOX operation connect the voice control unit VOX-3 (option), set the STANDBY switch to REC and turn the VOX GAIN control of VOX-3 to ON position. Adjust the VOX sensitivity with the VOX GAIN control. The changeover between transmission and reception can be automatically accomplished by your voice. With the transceiver set in the VOX receiving mode, adjust the ANTI VOX GAIN knob to prevent VOX-3 from being erroneously operated by the sound from the speaker. Note that excessive tuning of the ANTI VOX GAIN knob will cause the ANTI VOX circuit to operate by the speaker noise, resulting in failure of smooth transmission. Use the DELAY TIME control for adjustment of the release time. For the details of the VOX operation, refer to the instruction book of VOX-3.

When the transceiver is used in CW mode, be sure to set the VOX GAIN control to OFF position because otherwise VOX-3 will remain operated.

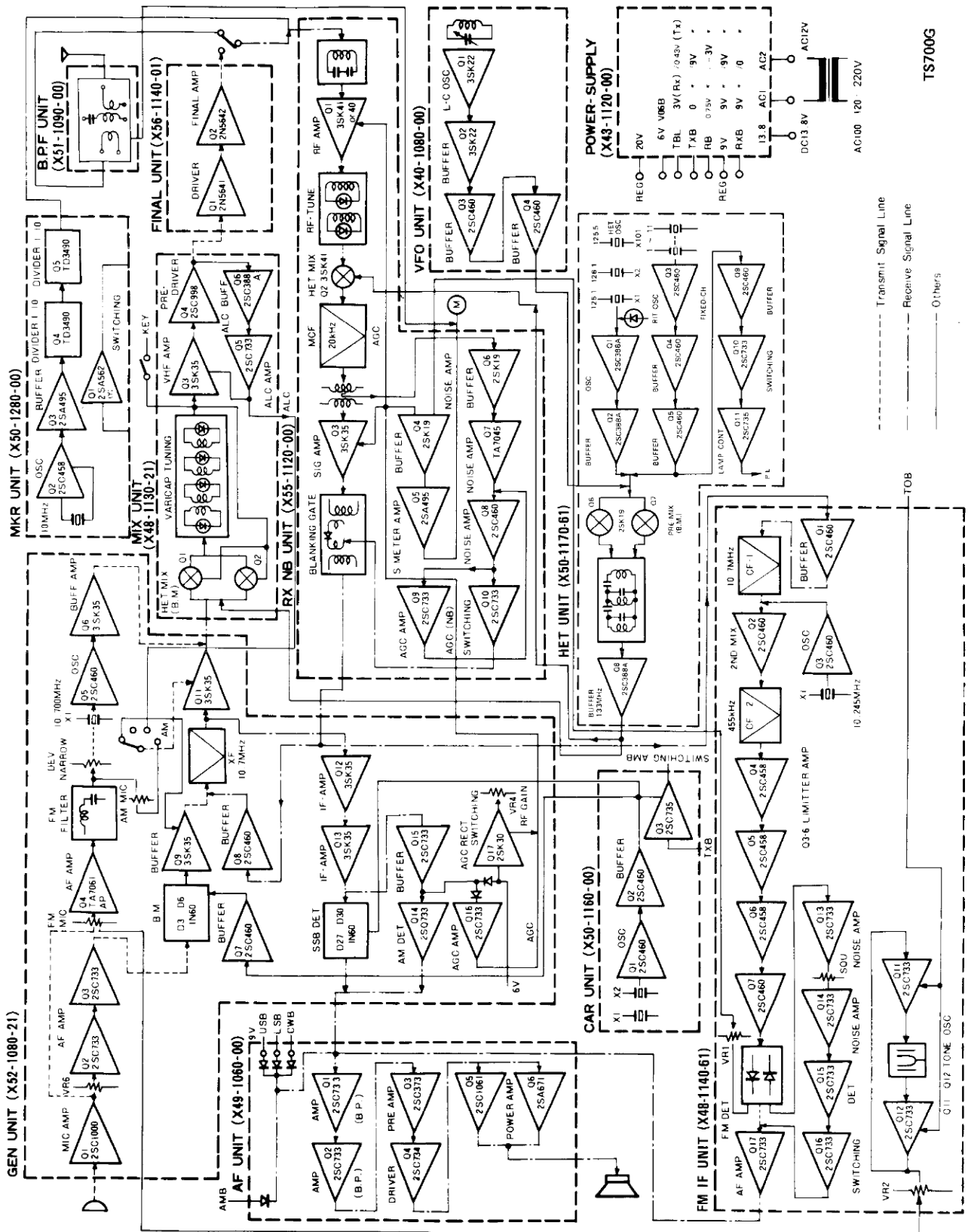

Fig. 13 TS-700G Block Diagram

SECTION 5. CIRCUIT DESCRIPTION

5-1. Block Diagram

The circuit block diagram of TS-700G is shown in Fig. 13. Solid-state parts used in this model are: 69 transistors, 18 FET's, 5 IC's and 117 diodes. Circuits are divided into individual units according to the operating systems and all units, with the exception of band pass filters (BPF), are wired and built on printed-circuit boards.

The receiver section operates as a single superheterodyne receiver in SSB mode and a double superheterodyne receiver in FM mode. The transmitter section is more versatile- it is a single conversion type and operates as a filter type unit in SSB mode, a unit with direct modulator using a variable reactance frequency shift element in FM mode, a unit of low power modulation system in AM, and as a unit of block bias keying system in CW mode.

Crystal Oscillator Frequencies

Carrier unit.....	USB	10.6985 MHz
	LSB	10.7015 MHz
	AM, CW	10.7006 MHz
Generator unit.....	FM	10.700 MHz
HET unit	144	125.100 MHz
	145	126.100 MHz

5-2. Unitized Circuits

(1) Carrier Unit (X50-1160-00)

This unit produces a carrier frequency for the generator unit during transmission but acts as a BFO for ring detection during reception. It is a two-transistor circuit with oscillator crystals and diodes. The diodes are for selecting the USB, LSB or CW crystal, depending on the mode of operation.

(2) Generator Unit (X52-1080-21)

The single-side-band (SSB) signal for transmission originates in this unit. Major components are a microphone amplifier, a two-transistor audio frequency amplifier, a ring modulator composed of 4 diodes, and a buffer. Other devices are: a low power modulator circuit for AM, a variable reactance frequency shift modulator for FM, a ring detector for SSB reception, an IF circuit for SSB, AM and CW, and an AM signal detector.

During SSB operation, this unit generates a double-side-band (DSB) signals- this signal is injected into the crystal filter and comes out as an SSB signal. During CW operation, the ring modulator is forced into unbalanced condition by biasing with a DC voltage and, in the unbalanced condition, produces the carrier.

(3) FM IF Unit (X48-1140-61)

During reception, the input signal to this unit comes

from the RX-NB unit. The signal passes through the 10.7 MHz ceramic filter and is then mixed for 455 kHz- the signal passes through the 455 kHz ceramic filter and is fed to the 455 kHz IF stage, whose 455 kHz output undergoes FM detection in the limiter amplifier circuit. The detected output of the amplifier divides into two paths, one to the squelch circuit and the other to the gate circuit. The output of the squelch circuit enters the same gate circuit. Thus, generation of intermediate frequency and squelching action are the two main functions of this unit for FM operation.

(4) MIX Unit (X48-1130-21)

This unit comprises a heterodyne mixer, voltage and power amplifiers for the transmitter section. The output of the generator unit enters this unit to get converted into a 144 MHz signal by balanced mixing. This signal is then boosted to a higher voltage level through the variable capacitance tuning circuit, and becomes substantially power-amplified by the pre-driver circuit. Block bias keying is effected by the balanced mixer and voltage amplifying FET for CW operation. The MIX unit also includes an ALC circuit.

(5) FINAL Unit (X56-1140-01)

This is a 10-watt power amplifier unit. All the necessary final circuits are built compactly on the chassis. A heat sink is also provided in this unit.

(6) BPF Unit (X51-1090-00)

The two functions of this unit are "antenna coupling" and "spurious signal removal". It couples the transmitter and receiver to the antenna, and removes the spurious during transmission. The RF output level is detected in this unit.

(7) MARKER Unit (X50-1280-00)

This unit is a circuit to generate the 100 kHz marker signal for calibration use. It holds a 10 MHz crystal oscillator and a two-stage IC counter circuit to produce marker signals at 100 kHz intervals.

(8) RX-NB Unit (X55-1120-00)

This unit is the RF part of the receiver section, and includes a noise blanker circuit (NB). The received signal entering this unit passes through the RF amplifier, heterodyne mixer and the crystal filter circuit and is then fed to the IF circuit.

When the NB switch on the front panel is set to OFF, the unit functions as an IF circuit after the crystal filter. With this switch set to ON, the circuit through which the IF signal passes is opened or closed according to the level of noise component of the incoming signal. The noise is discriminated from the signal by transistors on the basis of amplitude and frequency, more accurate noise detection and

removal can be effected, thus a clean information signal is obtained.

Pulse noises (coming from ignition coils of cars) and others which are distinctly at variance with normal signals such as SSB in terms of frequency and amplitude are accurately detected and removed. Not to be confused with such noises are those resembling the normal signals: for example, noise signals due to corona discharge or high-frequency welders near-by or to high-power oscillations (whose frequencies are outside but close to the IF band) in adjacent apparatus are beyond the capability of the noise blanker circuit. In this case, the desired signal will be distorted with noise. The unit also includes adjusting circuits for "S", "RF" and "center" meters.

(9) HET Unit (X50-1170-61)

The 133 MHz band heterodyne frequencies are available from this unit. The output frequency is produced by mixing its 125 MHz with the 8 MHz input from the VFO unit or with the frequency available from any of the crystal oscillator fixed channels. The mixing circuit is of balanced type. A band-pass filter (BPF) circuit which follows is to prevent unwanted frequencies from leaking out of this unit.

(10) VFO Unit (X40-1080-00)

A perfectly shielded VFO consists of 2 FET's, 2 transistors and 2 diodes. It is extremely stable, equivalent to that of the TS-900. Its adjustments are highly delicate; too delicate for a person not skilled to attempt any re-adjustment. For this reason, the user is advised not to disturb the setting of this unit; the warranty on this model is conditioned on the original setting.

(11) AF Unit (X49-1060-00)

This audio amplifier unit drives the speaker. The received signal, modulated, flows through 2 stages of band-pass amplification, 2 stages of AF amplification and 1 stage of complementary amplification. The load impedance is 8 ohms.

(12) Power Supply Unit (X43-1120-00)

An AC bridge rectifier is included in this power supply unit to make it meet both AC and DC needs. The DC 20V supply to the FINAL and AF units is produced by means of a voltage multiplier circuit working with a DC 13.8V input. The regulated 9V supply is made available by an IC through DC 13.8V. The above units are connected to each another through the individual terminals properly marked for easy identification. As a rule, the marking on each terminal corresponds to the name of the part of the units as shown in the table 5 below:

Table 5

Marking	Description
13.8V.....	13.8V
9V.....	9V
-6V.....	-6V
GND.....	Earth
TXX.....	Transmitter section
RXX.....	Receiver section
VRX.....	Variable resistor
IN.....	Input
OUT.....	Output
RL.....	Relay
SX.....	Switch
PLX.....	Pilot lamp

SECTION 6. ACCESSORIES

6-1. Accessories

For more enjoyable operation of your TS-700G, the following accessories are available from your dealer on optional basis:

*** Communication type microphone MC-50**

A uni-directional dynamic microphone exclusively designed for amateur radio band equipment, featuring excellent performance when used in noisy locations or used in VOX mode. Provided with a lock-in type PTT switch, the output impedance is switchable between 50 k Ω and 600 k Ω .

*** Ham clock HC-2**

A clock graduated in 24-hour system on the time dial with main prefixes for convenience of use for ham fans. Operates continuously for more than 1 year with one UM-1 dry battery.

*** Transceiver headphone HS-4**

Dynamic type headphone (8 ohms) specifically designed for use with transceivers to provide maximum clarity of sound. Equipped with functionally designed ear-pads of lightweight material for comfortable fit and extended hours of fatigue-less use.

*** Band-pass filter BPF-2A**

This band-pass filter efficiently eliminates radio interferences such as cross modulation, sensitivity suppression, etc. due to business use equipment whose frequencies are located close to 144 MHz amateur band. It also prevents spurious emissions.

6-2. Connection of VOX Unit

Your TS-700 can be readily connected to the VOX circuit (VOX-3). This connection permits the changeover between transmission and reception automatically by your voice fed into the microphone without using the standby switch or the microphone switch, making your QSO more enjoyable.

VOX-3 (option)

VOX-3 can be used simply by connecting the cord (supplied with VOX-3) to the VOX socket at the rear panel of the transceiver- no tools are required. The standby circuit of TS-700G is shown in Fig. 14 for reference.

Use of VOX-3

To operate the transceiver in combination with VOX-3, first set the STANDBY switch to REC and then turn the VOX GAIN knob of VOX-3 to ON position- VOX-3 is now ready for operation. Speak into the microphone and the transceiver is automatically set in the transmitting mode. If the transceiver fails to shift to the transmitting mode smoothly, adjust the VOX GAIN knob. Stop your talking into the microphone and the transceiver is again set in the receiving mode. The time required for the transceiver to shift from transmission to reception can be adjusted by the DELAY knob as desired. If VOX-3 is activated by the sound fed through the speaker to the microphone during reception, adjust the ANTI VOX knob. If VOX-3 is not used or the transceiver is to be operated in CW mode, the VOX GAIN knob must be set in the OFF position.

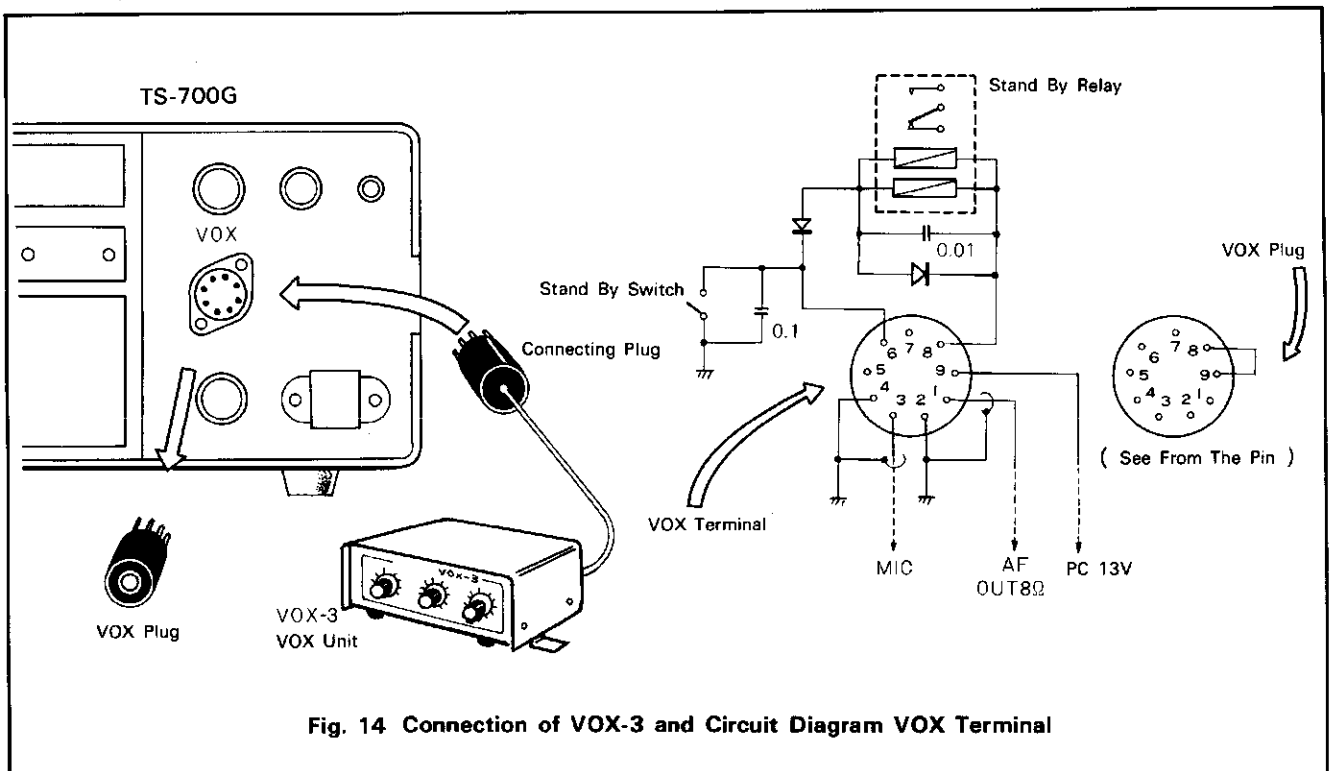

Fig. 14 Connection of VOX-3 and Circuit Diagram VOX Terminal

SECTION 7. ALIGNMENT

Your Model TS-700G is factory adjusted prior to shipment and no further adjustments are required. However, if any trouble is encountered, please send it to your dealer.

Frequency Adjustment

When fixed channel crystal oscillators are added in the transceiver, adjust their frequencies as outlined below (the relationship between the markings on the FIX CH knob and the crystal oscillator sockets are shown in Fig. 15):

1. Remove the two screws securing the top face of the case. Pull up the two grommets and open the top lid.
2. Connect a frequency counter to the point TP2 (Fig. 16) in HET unit (X50-1170-61). The frequency counter should be capable of reading up to 10 MHz.
3. Adjust the trimmers (TC1 ~ TC11) corresponding to the newly used crystal oscillator sockets to produce the desired oscillator frequencies (refer to Paragraph 4-5 "Operation with Fixed Channels").

Table 6

f_0 (MHz)	crystal oscillator frequency for FM, AM, and CW.
f_{USB} (MHz)	crystal oscillator frequency for USB.
f_{LSB} (MHz)	crystal oscillator frequency for LSB.
X (MHz)	desired operating frequency

BAND 1:

$$f_0 = X - (125.10 + 10.70) \text{ (MHz)}$$

BAND 2:

$$f_0 = X - (126.10 + 10.70) \text{ (MHz)}$$

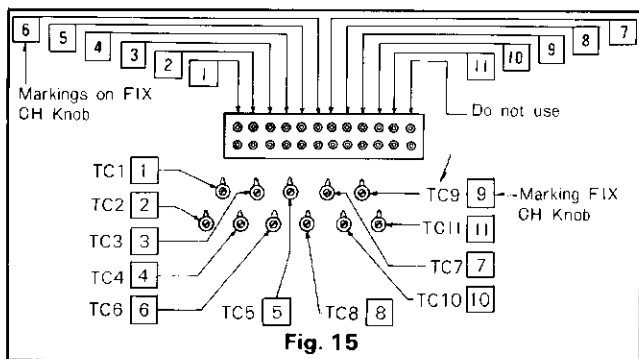

BAND 1:

$$f_{USB} = X - (125.100 + 10.700 - 0.0015) \text{ (MHz)}$$

BAND 2:

$$f_{USB} = X - (126.100 + 10.700 - 0.0015) \text{ (MHz)}$$

BAND 1:

$$f_{LSB} = X - (125.100 + 10.700 + 0.0015) \text{ (MHz)}$$

BAND 2:

$$f_{LSB} = X - (126.100 + 10.700 + 0.0015) \text{ (MHz)}$$

* Specifications for Crystal Oscillator Unit (option)

Type: HC-25/U

Order of oscillation wave: Fundamental wave

Frequency: 8.200 ~ 9.200 MHz

Oscillation circuit: Cl meter

Oscillating condition: 32 pf (parallel capacity)/25Ω or less (effective resistance)

Electrical characteristics:

* Operating temperature

-20°C ~ +60°C

* Allowable frequency deviation

Within $\pm 3 \times 10^{-5}$ (25°C)

* Frequency vs. temperature characteristic:

Within $\pm 3 \times 10^{-5} + (0 \sim 50^\circ\text{C})$

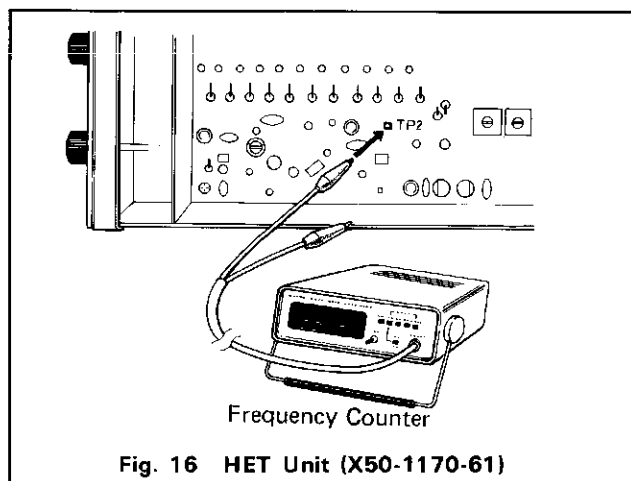

SECTION 8. TROUBLESHOOTING

The symptoms listed below are in no way indications that the transceiver is defective. If trouble with the transceiver cannot be remedied even after the following checks have been performed, consult your dealer or your nearest service station.

SYMPTOM	POSSIBLE CAUSES	REMEDY
* Turning on POWER switch will not light up pilot lamp.	<ol style="list-style-type: none"> 1. AC power cord is not fully inserted into the connector. 2. Improper connection of power cord. 3. Fuse is blown out. 	<ol style="list-style-type: none"> 1. Firmly insert the plug of the cord into the connector. 2. Plug in the cord fully. 3. Replace the fuse (if new fuse blows, the transceiver needs repair).
* Antenna is properly installed but the transceiver will not receive signals.	<ol style="list-style-type: none"> 1. PTT switch on the microphone is in "talk" position. 2. FIX CH switch is set in empty channel position. 3. CAL switch is set in ON position. 	<ol style="list-style-type: none"> 1. Turn PTT switch to "receive" position. 2. Rotate the switch to VFO position or to a channel position where the channel indicator lamp lights. 3. Turn CAL switch (SQUELCH knob) clockwise for OFF position.
* No background noise from the speaker in FM mode.	<ol style="list-style-type: none"> 1. Squelch circuit is in service. 	<ol style="list-style-type: none"> 1. Turn SQUELCH knob fully counterclockwise. (not CAL)
* Transceiver is connected to antenna, but no signal is received while "S" meter pointer remains deflected.	<ol style="list-style-type: none"> 1. RF GAIN control is set too low. 	<ol style="list-style-type: none"> 1. Turn RF GAIN control fully clockwise.
* Even in the absence of signal, "S" meter pointer remains deflected.	<ol style="list-style-type: none"> 1. RF GAIN control is set too low. 2. METER switch is set to CEN position in FM mode. 	<ol style="list-style-type: none"> 1. Turn RF GAIN control fully clockwise (if meter indication remains the same, the transceiver is defective). 2. Set METER switch to "S" position.
* SSB signal is being received but speaker output remains unintelligible.	<ol style="list-style-type: none"> 1. Transceiver is set for a wrong sideband. 	<ol style="list-style-type: none"> 1. Shift MODE switch to USB or to LSB.
* RIT knob is ineffective in fine tuning.	<ol style="list-style-type: none"> 1. RIT switch is in OFF position. 	<ol style="list-style-type: none"> 1. Set the switch to ON position.
* There is a frequency lag between transmission and reception.	<ol style="list-style-type: none"> 1. RIT knob is not in the "0" position while RIT switch is ON. 	<ol style="list-style-type: none"> 1. Set RIT switch to OFF, or set RIT knob to "0" position.
* Noise blanker circuit is not fully effective in suppressing noise.	<ol style="list-style-type: none"> 1. Strong signal exists close to the operating frequency. 2. Some interfering noise similar to SSB signal in waveform is coming in from a nearby source (such as high-frequency welder or corona discharging device). 	
* No RF power.	<ol style="list-style-type: none"> 1. Absence of 9-pin MT plug in VOX socket. 2. CAL switch is set in ON position. 	<ol style="list-style-type: none"> 1. Firmly connect the MT plug. 2. Turn clockwise the CAL.

SYMPTOM	POSSIBLE CAUSES	REMEDY
* No or little AM output	1. AM carrier VR is in the minimum position.	1. Adjust AM carrier VR for suitable output by turning it clockwise (about "5" position on the RF meter).
* Incoming signal is not attenuated at the ON position of CAL knob.	1. Absence of 9-pin MT plug in VOX socket.	1. Fit the MT plug to the socket.
* No output in SSB mode.	1. Microphone plug is improperly connected into the microphone jack. 2. SSB mic volume (MIC 2) is set too low.	1. Firmly connect the microphone plug. 2. Turn clockwise MIC 2 volume in transceiver.
* Too small a modulation factor in FM mode.	1. FM mic volume (MIC 1) is set too low.	1. Turn clockwise MIC 1 volume in transceiver.

TS-700G SCHEMATIC DIAGRAM

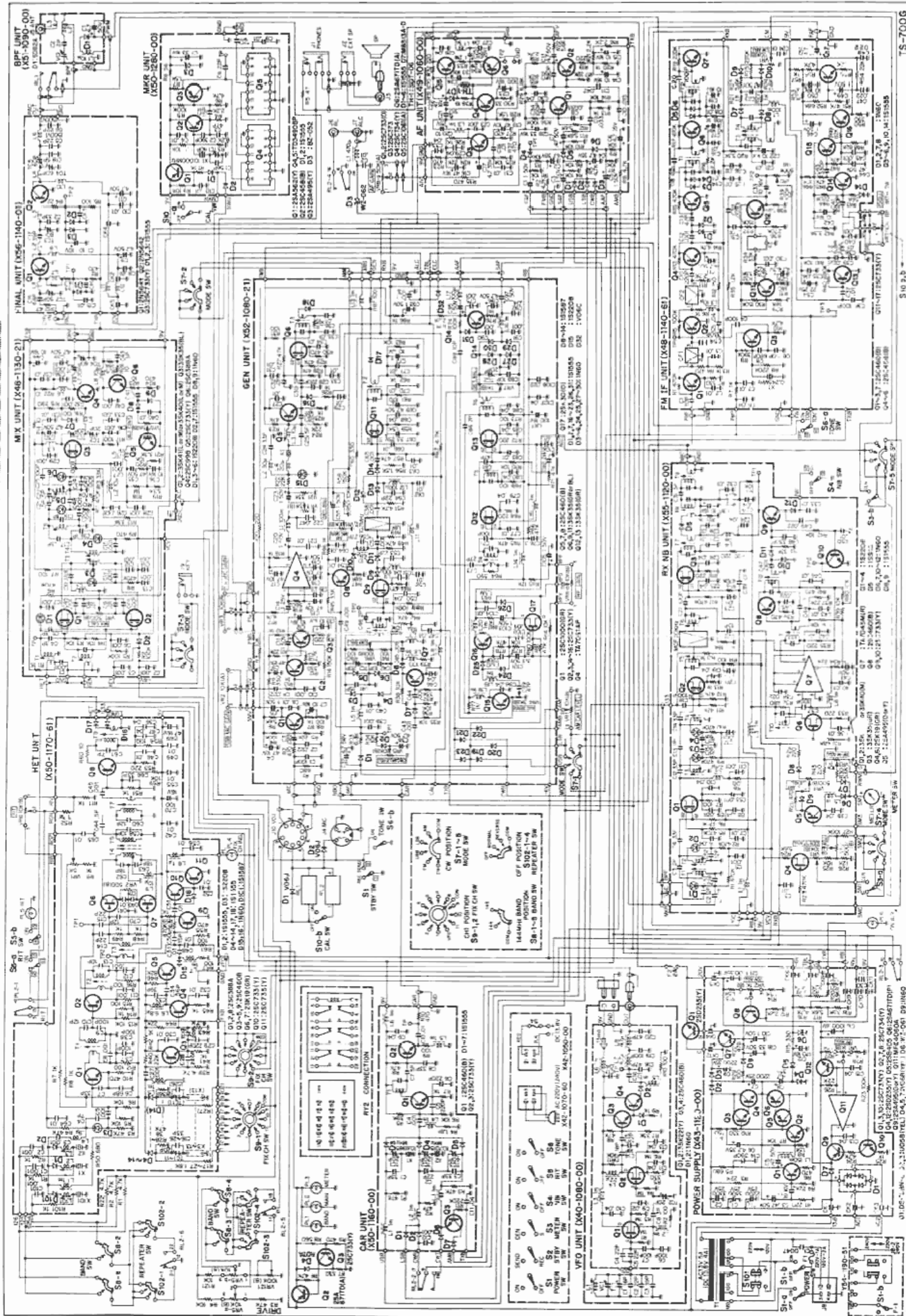

TOP & BOTTOM VIEW OF THE TS-700G

