

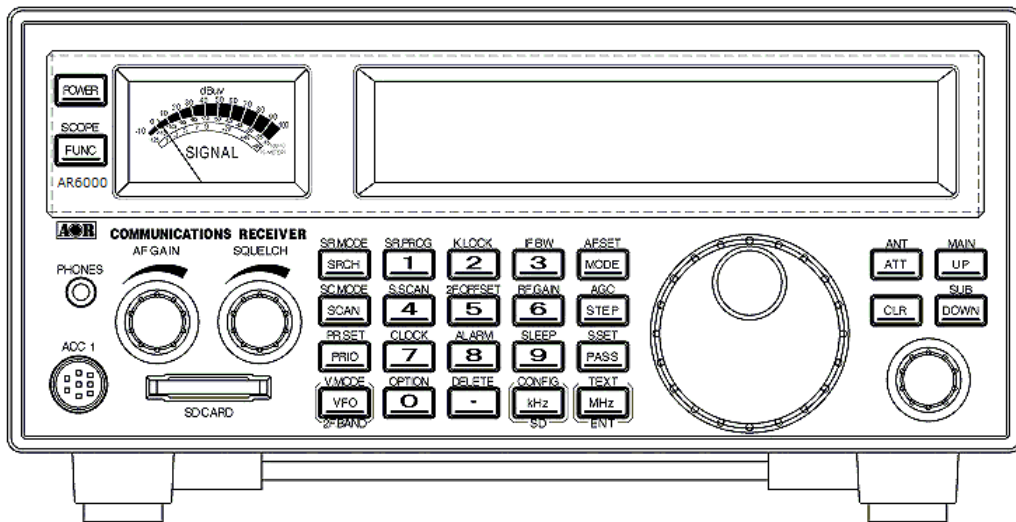

AR6000

Super Wide-band Multi-mode Receiver



Operating manual

AOR, LTD.

Table of Contents

1 INTRODUCTION	5
1-1 INTRODUCTION	5
1-2 TAKE CARE OF YOUR RECEIVER	7
1-3 INCLUDED IN THIS PACKAGE	8
2 CONTROLS AND FUNCTIONS	12
2-1 FRONT PANEL	12
2-2 REAR PANEL	13
2-3 LCD DISPLAY	14
2-4 KEYPAD	15
2-4-1 FRONT PANEL KEYS	15
3 GETTING STARTED	21
3-1 MAKING THE AR6000 READY FOR OPERATION	21
3-1-1 CONNECT THE ANTENNA	21
3-1-2 CONNECT POWER	21
3-2 SWITCHING ON FOR THE FIRST TIME	21
3-3 VOLUME CONTROL	23
3-4 SQUELCH CONTROL	23
3-5 VFO SELECTION	23
3-5-1 TUNING FREQUENCY	24
3-6 RECEIVE MODE	25
3-6-1 AUTO MODE SELECTION	26
3-6-2 RECEIVE MODE SELECTION	27
3-7 CHANGING THE FREQUENCY STEP	27
3-8 IF BANDWIDTH	28
3-8-1 MANUALLY SELECTING IF BANDWIDTH	29
4 ADDITIONAL SETTINGS	30
4-1 AGC (AUTOMATIC GAIN CONTROL)	30
4-2 ATTENUATOR / RF AMPLIFIER	30
4-3 RF GAIN	31
4-4 ANTENNA INPUT	31
4-5 KEYLOCK	32
5 ADVANCED FUNCTIONS	32
5-1 SPECTRUM DISPLAY	32
5-1-1 ACTIVATING THE SPECTRUM DISPLAY	32
5-1-2 CHANGING THE FREQUENCY SPAN	32

5-1-3	MOVING THE SPECTRUM.....	32
5-1-4	CHANGING THE MARKER FREQUENCY.....	33
5-1-5	DEACTIVATING THE SPECTRUM DISPLAY.....	33
5-2	MULTI CHANNEL RECEIVE.....	33
5-2-1	DUAL CHANNEL RECEIVE IN OFFSET MODE.....	33
5-2-2	DUAL BAND RECEIVE.....	34
5-2-3	TRIPLE CHANNEL RECEIVE.....	35
5-3	MANAGING AN SD CARD.....	36
5-3-1	FORMAT AN SD CARD.....	36
5-3-2	SD CARD INFORMATION.....	36
5-3-3	READ DATA FROM SD CARD.....	37
5-3-4	WRITE DATA TO SD CARD.....	38
5-3-5	RECORDING AUDIO.....	39
5-3-6	PLAYBACK AUDIO.....	40
5-3-7	DELETE FILES.....	40
6	MEMORY CHANNELS AND BANKS.....	41
6-1	MEMORY CHANNEL OVERVIEW.....	41
6-2	STORING VFO FREQUENCIES AND DATA INTO MEMORY.....	42
6-3	MEMORY READ.....	44
6-4	DELETE MEMORY CHANNEL.....	44
6-5	DELETE ALL MEMORY CHANNELS IN THE MEMORY BANK.....	44
7	SCAN – SCANNING MEMORY CHANNELS.....	45
7-1	SCAN – OUTLINE INTRODUCTION.....	45
7-2	STARTING SCAN.....	45
7-3	SELECTING A SCAN BANK.....	45
7-4	DISPLAYING A MEMORY CHANNEL TEXT.....	46
7-5	SELECT SCAN.....	46
7-5-1	ADDING SELECT SCAN CHANNELS IN MEMORY READ MODE.....	46
7-5-2	DELETE SELECT SCAN CHANNELS IN MEMORY READ MODE.....	46
7-5-3	STARTING / STOPPING SELECT SCAN.....	47
7-6	LOCKING OUT UNWANTED ACTIVE MEMORY CHANNELS (PASS).....	47
7-6-1	DELETE ALL PASS CHANNELS.....	48
7-7	SCAN GROUP.....	48
7-7-1	BANK LINK SETTING.....	48
7-7-2	SCAN PAUSE.....	49
7-7-3	SCAN DELAY.....	49
7-7-4	VOICE SCAN.....	50
7-7-5	MODE SCAN.....	51

8	SEARCH MODE	51
8-1	SEARCH TYPE	52
8-1-1	VFO SEARCH.....	52
8-1-2	PROGRAM SEARCH.....	53
8-1-3	CYBER SEARCH.....	57
8-2	SEARCH GROUP.....	58
8-2-1	BANK LINK SETTING	58
8-2-2	SEARCH PAUSE	58
8-2-3	SEARCH DELAY.....	59
8-2-4	VOICE SEARCH.....	59
8-2-5	AUTO STORE	60
9	CONFIGURATION MENU	60
9-1	CONFIGURE LAMP.....	61
9-2	CONFIGURE BEEP.....	62
9-3	CONFIGURE BPS (BAUD RATE)	62
9-4	CONFIGURE LOCAL (LOCATION SETTING).....	63
9-5	CONFIGURE SQL SKIP	63
9-6	CONFIGURE UNIT.....	63
9-7	CONFIGURE ANT PROGRAM	64
9-8	CONFIGURE SD INFO	65
9-9	CONFIGURE WRITE TO SD	66
9-10	CONFIGURE READ FROM SD	67
9-11	CONFIGURE SD FORMAT	68
9-12	CONFIGURE VERSION	69
9-13	CONFIGURE INITIALIZE (RESET).....	69
9-14	CONFIGURE MEMORY CHANNEL ASSIGNMENT	69
10	OPTION MENU	70
10-1	NOISE SQL (NOISE SQUELCH)	70
10-2	LSQL HYS (LEVEL SQUELCH HYSTERISIS)	70
10-3	NOTCH (AUTO NOTCH)	71
10-4	NR (NOISE REDUCTION).....	71
10-5	NB (NOISE BLANKER).....	72
10-6	SCR (ANALOG VOICE DESCRAMBLER)	72
10-7	IF-SFT (IF SHIFT).....	72
10-8	AFC (AUTOMATIC FREQUENCY CONTROL).....	73
10-9	CTCSS (CONTINUOUS TONE CONTROLLED SQUELCH SYSTEM).....	73
10-10	DCS (DIGITAL CODED SQUELCH).....	74
10-11	DTMF (DUAL TONE MULTI FREQUENCY).....	75

10-12	PRESEL (PRE-SELECTION FILTER)	76
10-13	VIDEO OUT (VIDEO OUTPUT)	76
10-14	VIDEO IMG (VIDEO MODULATION POLARITY)	77
11	MISCELLANEOUS FUNCTIONS	77
11-1	STEP ADJUST	77
11-2	SUB DIAL SETTING	78
11-3	VFO SETTING	79
11-3-1	TRANSFER FREQUENCY TO VFO	79
11-3-2	VFO SEARCH DELAY	80
11-3-3	VFO VOICE SQUELCH.....	80
11-4	AUDIO FILTERS	80
11-4-1	LPF (LOW PASS FILTER)	80
11-4-2	HF (HIGH PASS FILTER)	81
11-4-3	DE-EMPHASIS	82
11-4-4	CW PITCH.....	82
11-5	CLOCK	83
11-5-1	INITIAL SET	83
11-5-2	DISPLAYING THE CLOCK	85
11-5-3	ALARM PROGRAMMING	85
11-5-4	ALARM ACTIVATION.....	86
11-5-5	SLEEP TIMER.....	86
11-6	PRIORITY FUNCTION	87
11-6-1	CONFIGURING PRIORITY CHANNEL	87
11-6-2	ACTIVATING PRIORITY FUNCTION	88
11-7	RF GAIN CONTROL	88
12	PC CONTROL.....	89
12-1	USB INTERFACE	89
12-1-1	USB DRIVER	89
13	SPECIFICATIONS.....	90
14	LIMITED WARRANTY (USA only).....	91

1 INTRODUCTION

1-1 INTRODUCTION

Thank you for purchasing the AR6000 Super Wide-band Multi-mode Receiver.

AR6000 is designed using the latest technology to ensure the highest level of performance and reliability. If you are familiar with the AR5001D operations and functions, you will find it easy to use the new AR6000 receiver.

To obtain the best possible results from your AR6000, we strongly recommend that you read this manual and familiarize yourself with the receiver. It is acknowledged that sections of this manual are repetitive, but this is to enable the manual to be used as a reference book.

Every effort has been made to make this manual correct and up to date. Due to continuous developments of the receiver, we acknowledge that there may be some errors or omission anomalies.

© This manual is protected by copyright AOR, LTD. 2013. No information contained in this manual may be copied or transferred by any means without the prior written consent of AOR, LTD. AOR and the AOR logo, are trademarks of AOR, LTD. All other trademarks and names are acknowledged.

Main features:

- Wide frequency coverage: 9 kHz to 6 GHz, with no interruptions
(Cellular blocked for the US consumer version)
- 45.05 MHz IF DSP (Digital Signal Processing)
- HF direct sampling
- No AGC in the analog processing circuit
- Computer simulated high grade RF frontend
- PC controllable
- DDS (Direct Digital Synthesizer) local oscillator
- Accurate reference frequency (0.01 ppm with an optional GPS unit)
- Analog TV reception in both NTSC and PAL formats
- IF analog signal output (45.05 MHz, +/- 7.5 MHz for a total of 15 MHz bandwidth)
- Multi-mode unit capable of receiving AM (Synchronous), ISB, USB, LSB, CW, AIQ (AF-IQ),
WFM including FM stereo (optional headphone or stereo speakers required), NFM and
P25 (APCO25) digital (optional)
- Composite video output on the rear panel of the unit
- SD card interface
- Selectable IF bandwidths: 200 Hz, 500 Hz, 1kHz, 3 kHz, 6 kHz, 15 kHz, 30 kHz, 100 kHz, 200 kHz,
along with the ability to shift the IF
- CTCSS and DCS selectable squelch functions
- DTMF tone decode
- Built-in voice-inversion descrambling (Not available for the US consumer version)
- CW pitch control, AGC, AFC
- Auto-notch, noise reduction (NR), noise blanker (NB)
- Fast Fourier Transform (FFT) analyzer for fast spectrum display processing
- 12 kHz (analog) I/Q output for DRM® PC receiver
- USB 2.0 interface
- Two antenna ports (Type N)
- Up to 4 antenna ports (Optional antenna switch required)
- 5 VFO's, 2,000 alphanumeric memories
- Simultaneous monitoring of up to three channels
- Digital Voice Recording (with a SD memory card)
- I/Q output with 0.9 MHz bandwidth (with an optional I/Q unit)
- LAN (Local Area Network) control (with an optional LAN interface)
- P25 (APCO25) decode (conventional mode) (with an optional P25 unit)
- Antenna input level readout (in dBm, dB μ selectable)

1-2 TAKE CARE OF YOUR RECEIVER

There are no internal operator adjustments needed. In the unlikely event of service being required, please contact us for technical assistance.

Do not use or leave the receiver in direct sunlight. It is best to avoid locations where excessive heat, humidity, dust and vibrations are present. Always keep the AR6000 free from dust and moisture. Use a soft, dry cloth to gently wipe the external surfaces clean; never use abrasive cleaners or organic solvents which may damage certain parts.

Treat the AR6000 with care; avoid spilling or leaking liquids into the receiver and the associated power supply. Special care should be taken to avoid liquids from entering the area around the controls and through the speaker grill or via the connection jacks.

The AR6000 is designed to operate from a good quality regulated DC power supply of 10.7 to 16.0 V, which should be capable of supplying 2A. Never connect the AR6000 directly to an AC power outlet.

The polarity of the DC input jack is clearly marked; the chassis of the receiver is at negative ground.

SAFETY NOTICE – Always disconnect the power supply from the AC outlet or switch off the main power switch on the rear panel when the receiver is not in use for a long period of time. If used mobile, it should be noted that the AR6000 has NOT been manufactured or tested to meet any specific mobile safety requirements. The AR6000 has no user adjustable internal parts.

If using the AR6000 as a base station, the best short wave reception is usually achieved by grounding your shortwave antenna with a separate external earth (or ground) rod. However, consider the implications carefully if your AC building supply uses a Protective Multiple Earth (PME) system.

If in doubt, consult a qualified electrician. Never earth (ground) to a gas pipe!

The AR6000 has two antenna connectors. These are intended for connection to a 50Ω (unbalanced) coaxial fed antenna such as a discone, dipole, Yagi, etc.

When installing an antenna, avoid power cables. Ensure that you do not confuse the antenna and the IF output connector as they are located close to each other.

Operating anomalies

Should the AR6000 appear to behave strangely, normal operations may be easily achieved by performing the following steps:

1. **Symptom:** No control of the receiver.
Action: Turn off the power switch on the front panel. Leave it off for approximately 10 seconds. Turn the power switch back on again.
Normal operation should be restored.
2. **Symptom:** The display freezes.
Action: Turn off the main power switch on the rear panel. Leave it off for approximately 10 seconds. Turn the power switch back on again.
Normal operation should be restored.

Should the AR6000 still behave strangely, try a RESET as explained in chapter 9-13.

1-3 INCLUDED IN THIS PACKAGE

The following items are provided in this package:

- 1 AR6000 receiver
- 1 AC power adapter
- 1 Operating manual (this booklet)
- 1 Control command list
- 1 4GB SD memory card

Terminology

Search & Scan

If you have not used a wide band receiver before or is not familiar with the terminology used, it is very important to understand the difference between **SEARCH** and **SCAN** modes.

SEARCH: The AR6000 provides several operations where transmissions (active frequencies) may be automatically located by sweeping the receiver over a wide frequency range, either from the currently displayed frequency traveling upwards (or downwards) in a specified tuning increment (step) or by sweeping over-and-over between two specified frequency limits. This process is known as **SEARCHING**. As the name implies, this process can take a long time to find transmissions due to their 'often intermittent' and brief nature. For this reason, it is best to slice large frequency ranges into smaller, more manageable pieces

where they may be intensely monitored.

When examining large frequency segments, it is common to find that 90% of the frequencies are inactive and only a small number of the remaining constitute what you really want. Searching still remains the best way to initially locate active and interesting transmissions (in conjunction with a good frequency listing and band plan).

SCAN: Once active transmissions have been identified (either by searching or by using a good frequency guide), it is more efficient to store the data into memories which can be rapidly and automatically monitored in succession, stopping when activity is encountered. This is a much more efficient means of monitoring the most wanted frequencies as you have targeted 100% of what you most want to hear. By contrast, searching is very inefficient for day-to-day monitoring.

Note: For the search & scan functions to operate properly, it is very important to advance the squelch to cancel background noise. This is because the AR6000 believes that it has found an active frequency when the squelch opens and the "BUSY" indicator lights up. Advance the squelch control clockwise until the background noise is just cancelled; this is known as the "threshold" position. If the squelch control is advanced too far, weaker signals may be missed.

More details about the remarkable features of the AR6000

High frequency (45.05 MHz) IF output

The AR6000 has a 45.05 MHz analog IF output with 15 MHz bandwidth. The input signal to the 45.05 MHz IF stage is directly sent to the A/D converter for digital processing. This IF output signal may be suitable as an RF front end for radio signal analysis applications.

High Stability Frequency Standard

When an optional GPS unit is connected, the internal reference oscillator (10 MHz) will be locked by the GPS receiver, and the highest stability reference signal (0.01 ppm) will be obtained. This is ideal for frequency coherent operation and DF (Direction Finding) applications.

DDS (Direct Digital Synthesizer)

The AR6000 uses a high speed DDS for the 1st local oscillator. Unlike a standard PLL (Phased Locked Loop) circuit for the local oscillator, the DDS enables very high speed scanning as it generates signals instantaneously, controlled by the CPU (Micro Processor).

I/Q Digital Output (Optional)

The I/Q stands for In-Phase/Quadrature-Phase.

In the 45.05 MHz IF stage, I/Q output is available as an optional feature. The I/Q digital signal consists of two (2) different digital signals with phases shifted 90 degrees. The I/Q output is provided through a continuously isochronous USB 2.0 standard interface. By using the I/Q digital output, the streamed data can be stored on a PC hard disk for future signal analysis.

The I/Q digital output of the AR6000 has a wide dynamic range (without AGC processing) floating point data format.

FFT (Fast Fourier Transform)

The AR6000 utilizes FFT (Fast Fourier Transform) technology for high speed spectrum scanning.

FFT enables refreshment of the spectrum display more than 10 times per second for a 10 MHz span (at 500 Hz RBW). The AR6000 scans 10 MHz of bandwidth.

LAN (Local Area Network) connection

When an optional (external) LAN interface is connected, the AR6000 can be remotely controlled through the internet.

Triple channel reception (Receive three frequencies simultaneously)

Any frequency below 25 MHz can be received independently, separate from a frequency above 25 MHz. Therefore, two (2) separate frequencies can be received simultaneously. Furthermore, any two (2) frequencies above 25 MHz (within a range of +/- 5 MHz from the receive frequency) can also be selected and received simultaneously. Therefore, up to three (3) frequencies can be received at the same time.

Receive Mode / Additional Features

WFM (Wide FM)

- Stereo sound (auto detected), Selectable de-emphasis 50 μ S/75 μ S
- Stereo output is available from the 3.5 mm stereo jack on the front panel.
(External stereo headphones or speakers required to monitor stereo transmissions.)

NFM (Narrow FM)

- Built-in DCS (Digital Coded Squelch)
- Built-in CTCSS (Continuous Tone Coded Squelch System)
- Built-in Voice Inversion Descrambler (2,000 Hz ~ 7,000 Hz in 50 Hz step) (Not available on US consumer version)

- P25 (APCO25) decoding (with optional APCO25 board) (conventional non-encrypted mode only)
- Built-in AFC (Automatic Frequency Control)

AM (Amplitude Modulation)

- Envelope Detection (Normal AM decoder)
- Synchronous Detection
 1. DSB (Double Side Band) synchronous
 2. SSB (Single Side Band) USB/LSB (Upper Side Band/Lower Side Band) selectable synchronous
- AGC (Automatic Gain Control) mode/Manual RF gain mode

SSB (Single Side Band)

- USB/LSB selectable
- AGC mode/Manual RF gain mode

ISB (Independent Side Band)

- Simultaneously decoded LSB and USB (Stereo Output)
- AGC mode/Manual RF gain mode

CW (Continuous Wave)

- Built-in narrow band IF filter 200 Hz/500 Hz
- Adjustable tone pitch 300 ~ 1100 Hz (50 Hz step)

NB (Noise Blanker)

- Operates in AM, SSB, and ISB modes

Auto Notch Filter

- Effective to suppress a cyclic noise signal.

IF Shift

- Operates in SSB, AM, and CW mode.
- Shift width: -1200 Hz ~ +1200 Hz (50 Hz step)

Selectable Squelch mode

- VSQ (Voice Squelch) or LSQ (Level Squelch) can be selected.

DVR (Digital Voice Recorder)

- Received audio can be recorded on a SD memory card in WAV format.

Analog output for DRM® (Digital Radio Mondiale)

- 12 kHz IF (I/Q) analog output for DRM® PC receiver

2 CONTROLS AND FUNCTIONS

2-1 FRONT PANEL

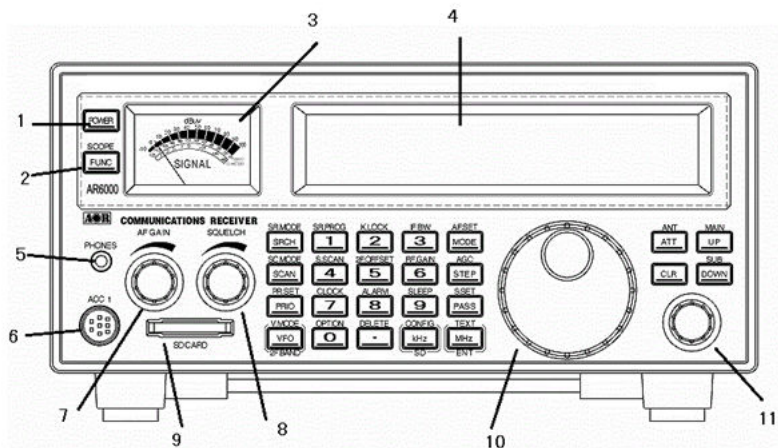

1. Power On/Off switch
2. Function switch
3. Analog S meter
4. LCD (Liquid Crystal Display)
5. Stereo headphone jack (3.5 mm stereo type)

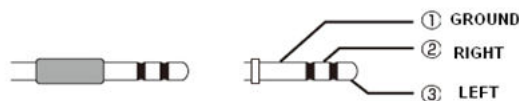

6. ACC1 (Accessory connector)

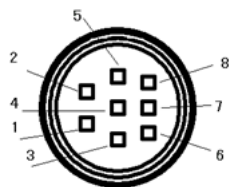

Pin #1	12 VDC output (30 mA max.)
Pin #2	Detector output
Pin #3	External mute input
Pin #4	Control 1
Pin #5	Control 2
Pin #6	GPS time pulse input
Pin #7	Low level audio output (2.5 mV @600 Ω)
Pin #8	Ground

7. AF Gain control
8. Squelch control
9. SD card slot
10. Main dial
11. Sub dial

2-2 REAR PANEL

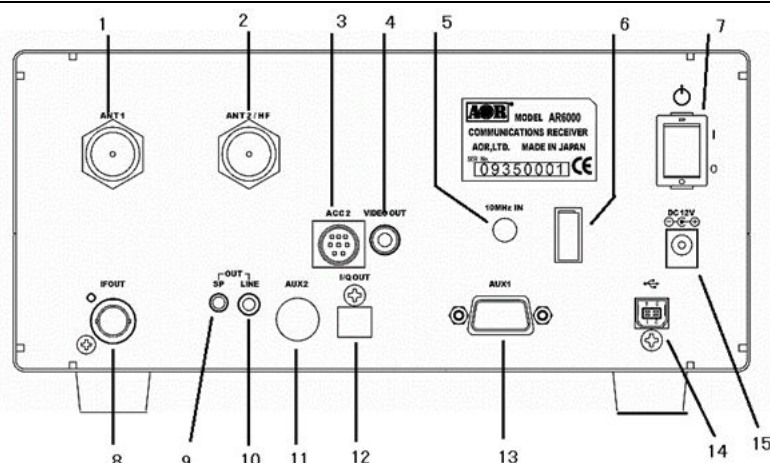

1. Antenna connector 1 (N type)
 2. Antenna connector 2 (N type)
 3. ACC2 (Accessory 2) connector
- | | AF | IF | I/Q |
|-------|--------------|---------------|---------------|
| ANT 1 | 25MHz-6GHz | 100kHz-6GHz | 100kHz-6GHz |
| ANT 2 | 9kHz-3.15GHz | 25MHz-3.15GHz | 25MHz-3.15GHz |

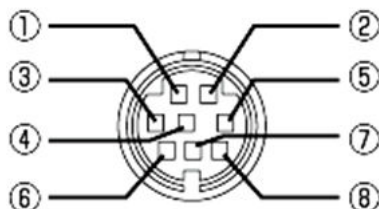

Pin #	Description	Pin #	Description
1	12V DC output (50mA max.)	5	Antenna switch A
2	No Connection	6	Antenna switch B
3	No Connection	7	No connection
4	No Connection	8	Ground

4. Composite video output (RCA type) 75Ω 1V p-p
5. External 10 MHz reference signal input connector (SMA type) (2 dBm +/- 2dB)
6. Power cable clamp
7. Main power switch
8. 45.05 MHz IF output connector (BNC type). +/-7.5MHz between 100kHz and 6GHz.
9. External speaker output (3.5 mm mono)
10. Line output connector (3.5 mm stereo, -10 dBm/600Ω). (Can be selected as 12 kHz I/Q output)
11. AUX2 (Auxiliary connector 2) Interface for an optional GPS unit
12. I/Q output connector (Optional, USB type B connector). 0.9MHz BW from 100kHz to 6GHz.
13. AUX1 (Auxiliary connector 1) D-Sub 9 Male, for expanded function (such as optional Ethernet controller) or RS-232C serial control interface.
14. USB (2.0) connector (USB type B connector)
15. 10.7-16 VDC power input (2A@12V)

2-3 LCD DISPLAY



Frequency display mode



Band scope mode

Icon	Function
F	Function switch
O	Dual channel receive (offset mode)
D	Dual band receive (HF and V/U)
	GPS status (optional) Lit: Frequency reference 0.01 ppm Blink: Frequency reference 0.1 ppm Not lit: No GPS installed
	Key lock/Remote control mode
ALARM	Alarm function activated
SLEEP	Sleep function activated
REC	SD card status (REC: Recording, SD: Card detected)
PRIO	Priority function activated
ANT	Antenna input
B	Busy (Squelch open)
-120.0dB	S reading / Antenna input level (in dBm when amplifier is off.)
ATT	Attenuation level
AMP	RF amplifier on
AUTO	Auto receive mode
ST: 009.000k	Frequency step
L-BANK	Bank link
VFO	Operation mode (VFO, MEM, SCAN, S.SCAN, SRCH, CYBER)
PAUSE	Scan/Search pause
VCS	Voice scan mode
PASS	Frequency pass
AS-M	Auto memory store function activated
DCS	DCS (Digital Code Squelch) function activated
TONE	CTCSS function activated
STEP-ADJ	Step adjust function activated
145.000000	Receiving frequency
=	AGC off
BW 15k	IF bandwidth
FM	Receive mode
VA	VFO, channel number
SPAN	FFT display span (0.4 ~ 10.0 MHz)
	Audio balance (displayed in offset mode, dual band receive mode)

2-4 KEYPAD

Keypad conventions

Most keys have secondary functions; their functions are printed on the panel. However, due to the restriction of available size, not all functions can be shown on the keypad printing.

For the secondary functions of the AR6000, they are indicated with white characters above each key. To access the secondary function, press the **[FUNC]** key, and then press the respective key.

2-4-1 FRONT PANEL KEYS

POWER

This key is located on the upper left corner of the front panel.

Press this key to power on the AR6000. To power off the AR6000, press and hold this key for two seconds.

FUNC

The function key is used to select secondary functions on the keypad. When pressed, “F” in reverse contrast appears on the top left corner of the LCD. The first function of the keys is printed on their face; the secondary function is printed in white directly above the corresponding key.

To cancel the **[FUNC]**, press this key again.

Press and hold the **[FUNC]** key for two seconds to go into the FFT display mode. To cancel the FFT display mode, press the **[FUNC]** key again.

SRCH - SR. MODE

Press this key to go into search mode and initiate **SEARCH**. If the receiver stops on an unwanted busy channel during search, it can be resumed using the **[UP]** key or **[DOWN]** key or by rotating the main dial.

To cancel search, press the **[SRCH]** key again or press the **[VFO]** key.

Press the **[FUNC]** key, and press the **[SRCH]** key to activate a sub menu where bank link, pause, delay, voice search, and auto-store function can be configured.

SCAN – SC. MODE

Press this key to go into memory recall mode.

The bank number can be selected using the sub dial, channel number using the main dial and four digit bank/channel number using the numeric key switch.

Press the **[SCAN]** key again to initiate **SCAN**. If the receiver stops on an unwanted busy channel during

scan, it can be resumed using the **[UP]** key or **[DOWN]** key or by rotating the main dial.

To cancel scan, press the **[SCAN]** key again or press the **[VFO]** key.

Press the **[FUNC]** key, and press the **[SCAN]** key to activate a sub menu where bank link, pause, delay, level squelch, and voice squelch function can be configured.

PRIO – PR. SET

Press the **[PRIO]** key to activate/deactivate the priority function.

“PRIO” appears on the center top of the LCD when priority frequency is currently active (busy).

Press the **[FUNC]** key, and press the **[PRIO]** key to select the priority channel followed by the interval of sampling.

VFO – V. MODE / 2F. BAND

Press this key to select **VFO** mode. The AR6000 has 5 **VFOs** (**VFO-A** through **VFO-E**) and the selected VFO is identified by “VA”, “VB”, “VC”, “VD”, and “VE” icons on the right bottom of the LCD.

Press the **[FUNC]** key, and press the **[VFO]** key to access the VFO search menu where Delay, Voice squelch and Mode squelch can be configured.

Press the **[FUNC]** key, then press and hold the **[VFO]** key for two seconds to activate/deactivate the dual band receive function.

1 – SR. PROG

Figure ONE for the numeric input of frequencies, bank, channel numbers, etc.

Press the **[FUNC]** key, and press the **[1]** key to activate the Search Program menu where bank number, lower frequency limit, upper frequency limit, receive mode, and text tag can be programmed.

2 – K. LOCK

Figure TWO for the numeric input of frequencies, bank, channel numbers, etc.

Press the **[FUNC]** key, and press the **[2]** key to activate the Key lock function. While activated, all front panel keys except the **[FUNC]** key, and **[POWER]** key are disabled to prevent accidental misoperation of the receiver. However, the volume and squelch controls remain operative.

3 – IF BW

Figure THREE for the numeric input of frequencies, bank, channel numbers, etc.

Press the **[FUNC]** key, and press the **[3]** key to activate the IF bandwidth menu. In normal operation, “AUTO” will be displayed on the LCD and the IF bandwidth will be automatically selected according to the band plan. To change the bandwidth manually, rotate the sub dial to select the desired bandwidth. To accept the new bandwidth, press the **[MHz]** key.

4 – S. SCAN

Figure FOUR for the numeric input of frequencies, bank, channel numbers, etc.

Press the **[FUNC]** key, and press the **[4]** key to activate SELECT SCAN. Select scan enables you to ‘tag’ memory channels to make a temporary list of up to 100 channels in the same memory bank for scanning in a separate list called SELECT SCAN LIST.

5 – 2F. OFFSET

Figure FIVE for the numeric input of frequencies, bank, channel numbers, etc.

Press the **[FUNC]** key, and press the **[5]** key for two seconds to activate/deactivate the dual frequency receive function in offset mode.

6 - RF. GAIN

Figure SIX for the numeric input of frequencies, bank, channel numbers, etc.

Press the **[FUNC]** key, and press the **[6]** key to activate the manual RF gain control. To change the RF gain manually, rotate the squelch knob. To cancel the manual RF gain control, repeat the above steps.

Note: The manual RF gain control is not available while the receiver is in AGC mode.

7 - CLOCK

Figure SEVEN for the numeric input of frequencies, bank, channel numbers, etc.

Press the **[FUNC]** key, and press the **[7]** key to display the current time.

Rotating the sub dial allows you to select between the two clocks.

To set the clock, press the **[FUNC]** key and then press and hold the **[7]** key for two seconds.

On the screen, you can select 12H/24H, set the date and time using the sub dial.

Press the **[MHz]** key to confirm entry.

8 - ALARM

Figure EIGHT for the numeric input of frequencies, bank, channel numbers, etc.

Press the **[FUNC]** key, and press the **[8]** key to activate the alarm function which automatically turns on the receiver at the preprogrammed time or sound a beep.

9 - SLEEP

Figure NINE for the numeric input of frequencies, bank, channel numbers, etc.

Press the **[FUNC]** key, and press the **[9]** key to activate the sleep function to turn the receiver off automatically at the preprogrammed time.

0 - OPTION

Figure ZERO for the numeric input of frequencies, bank, channel numbers, etc.

Press the **[FUNC]** key, and press the **[0]** key to activate the option menu.

. - DELETE

Use during the MHz frequency input to separate the MHz from the rest of the entry of kHz and Hz.

For example, the entry of 88.300000 MHz would be **[8][8][.][3]** [MHz].

Note: Frequencies below 3.0 MHz (3000 kHz) are always displayed as kHz regardless of input format.

In memory mode, press the **[FUNC]** key, and press the **[.]** to display the memory channel to be deleted.

Press the **[FUNC]** key, and then press and hold the **[.]** key for two seconds to activate the delete menu.

kHz – CONFIG/SD

The **[kHz]** key is used to accept frequency input from the numeric keypad in kHz format.

For example, entering of 954 kHz, press **[9][5][4][kHz]**. The LCD will display 954.000 kHz.

Note: Entering a decimal [.] before the number will result a preceding zero to be added automatically.

Press the **[FUNC]** key, and press the **[kHz]** key to activate the configuration menu.

Press the **[kHz]** while an SD memory card is inserted to activate the audio playback function.

Using the **[UP]** key or **[DOWN]** key to select the recorded file, press the **[MHz]** key to playback audio. To stop playback, press the **[CLR]** key.

Press and hold the **[kHz]** for two seconds while an SD memory card is inserted to start recording audio. To stop recording, press the **[CLR]** key.

MODE – AF. SET

Press this key to select the receive mode. Rotate the sub dial to select the desired received mode, and press the **[MHz]** key to confirm the selection.

To select AUTOMODE, press and hold the **[MODE]** key for two seconds. The AR6000 will automatically select the receive mode, IF bandwidth, and frequency step from the pre-programmed band plan. When in auto mode, “AUTO” is displayed above the frequency on the LCD.

Press the **[FUNC]** key, and press the **[MODE]** key to activate the AF. SET (Audio frequency setup) menu to configure the LPF (Low Pass Filter), HPF (High Pass Filter), De-emphasis, and CW pitch frequency.

STEP - AGC

Press this key to select the frequency step size for tuning the receiver. If “AUTO” is displayed on the LCD, the frequency step will automatically be determined from the receiver’s band plan.

To change the frequency step, press the **[STEP]** key. Rotate the sub dial to select the desired frequency step, and then press the **[MHz]** key.

Press the **[FUNC]** key, and then press the **[STEP]** key to activate the AGC (Automatic Gain Control) menu. In this menu, “FAST”, “MIDDLE”, “SLOW”, or “OFF” can be selected. Usually, **FAST** is used to receive CW, **MEDIUM** for AM and FM, and **SLOW** for SSB mode. However, this option cannot be configured in the FM mode.

When AGC is set to OFF, two horizontal bars are displayed on the LCD above the “kHz” or “MHz” icon.

PASS – S. SET

This key is used to PASS (skip over) unwanted active frequencies in search mode and scan mode.

In search mode, the unwanted frequencies are stored in the PASS LIST where they may be added to, deleted, or edited.

In scan mode, the memory is locked out and is skipped. While in scan mode or memory channel read mode, press the **[FUNC]** key, and then press the **[PASS]** key. This will add the displayed channel to the SELECT SCAN list. This is a special temporary notepad memory bank.

The **[PASS]** key is also used to select on/off of certain options such as step adjust and select defaults in other menus.

MHz – ENT/TEXT

This key has three functions.

MHz – This key is used to enter frequencies as MHz in VFO mode.

For example, to set a frequency of 88.300 MHz, enter the key sequence **[8][8][.][3][MHz]**.

There is no need to add the remaining zeros to the right once the **[MHz]** key is pressed.

ENT – This key is used to confirm entry in most menus.

If this key is held for two seconds in VFO mode, the AR6000 goes in to memory write mode.

Use the main dial knob to select the desired memory channel number, sub dial for memory bank to store into memory. Press this key again to enter a memory text screen of up to 12 characters to be added to each memory channel.

TEXT – Press the **[FUNC]** key, and then press the **[MHz]** key to display the memory texts.

ATT – ANT

This key is used to select the RF attenuator menu. The menu has a selection of AUTO, AMP 0 dB, 0 dB, -10 dB, or -20 dB.

Press the **[FUNC]** key, and then press the **[ATT]** key to activate the antenna input selection menu.

The menu has a selection of 1, 2, 3, 4, and PRG. To use the antenna 3 and 4, an optional AS5001 antenna relay will be required.

CLR

The CLEAR key is used to cancel frequency entry during programming or exit from a menu.

UP - MAIN

In VFO mode, press this key to change the displayed frequency to be incremented in an upward direction by one step.

In VFO mode, press and hold this key for two seconds to activate frequency search.

In memory read mode, press and hold this key for two seconds to activate scan.

In memory text input mode, this key will move the cursor to the next space.

In dual band/dual frequency mode, press the **[FUNC]** key, and then press and hold this key to activate the audio level balance adjust menu for the main band.

DOWN - SUB

In VFO mode, press this key to change the displayed frequency to be incremented in a downward direction by one step.

In VFO mode, press and hold this key for two seconds to activate frequency search.

In memory read mode, press and hold this key for two seconds to activate scan.

In memory text input mode, this key will move the cursor to the next space.

In dual band/dual frequency mode, press the **[FUNC]** key, and then press and hold this key to activate the audio level balance adjust menu for the sub band.

3 GETTING STARTED

3-1 MAKING THE AR6000 READY FOR OPERATION

3-1-1 CONNECT THE ANTENNA

There are two N antenna connectors on the rear panel:

	AF	IF	I/Q
ANT 1	25MHz-6GHz	100kHz-6GHz	100kHz-6GHz
ANT 2	9kHz-3.15GHz	100kHz-3.15GHz	100kHz-3.15GHz

3-1-2 CONNECT POWER

Connect the power to the DC power jack on the rear panel of the AR6000.

A supplied AC power adapter or a regulated DC power supply (10.7 ~ 16.0V with capacity 2A) may be used.

Do not connect to a 24V system.

3-2 SWITCHING ON FOR THE FIRST TIME

Turn on the power switch on the rear panel of the AR6000. This is the main power switch.

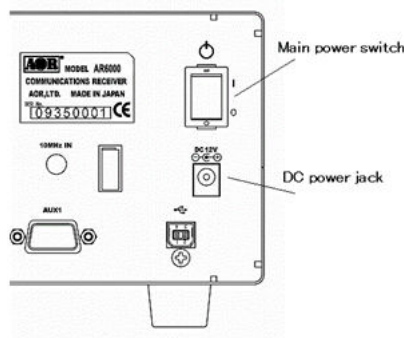

The clock will be displayed on the LCD.

Press the power switch on the front panel of the AR6000.

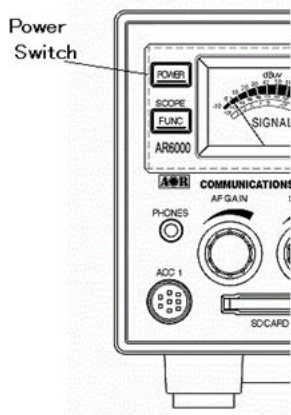

As you press the power switch, a 'click' will be heard.

Please be careful NOT to switch on the receiver with an earphone connected because there may be an audible click when the unit is switched on and the volume may be accidentally set too high.



Opening screen

After the opening screen appears on the LCD, the main screen will then be displayed.



Main screen (sample)

To power off the AR6000, press and hold the power switch on the front panel for two seconds. After "AR6000 SHUT DOWN" message is displayed, the receiver will automatically power off.

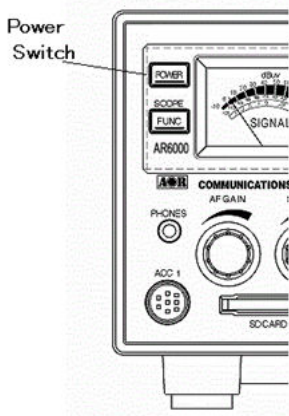

3-3 VOLUME CONTROL

To change the volume (audio) level, rotate the volume control (AF gain) clockwise to increase, and counterclockwise to decrease.

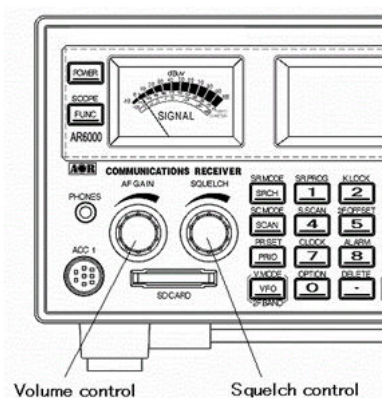

The audio level bar will be indicated on the LCD.

3-4 SQUELCH CONTROL

To change the squelch level, rotate the squelch control clockwise to increase, and counterclockwise to decrease. The squelch level will be indicated on the LCD.



After setting the squelch level, the LCD will return to original display.

While squelch opens, “B” (busy) will appear in reverse contrast on the top left of the LCD.

3-5 VFO SELECTION

The AR6000 has five (5) VFOs identified as “VA” through “VE” on the right bottom of the LCD.

The term VFO historically means ‘*Variable Frequency Oscillator*’ and today refers to a tunable data storage which contains frequency, step, step-adjust, attenuator etc. Pressing the [VFO] key each time will select the one VFO out of five.

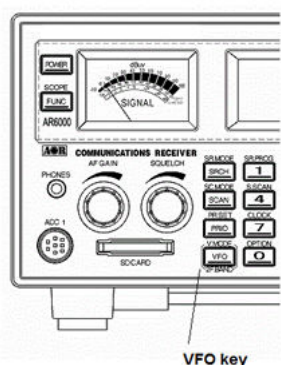

Each VFO has a specific function under certain configurations.

VFO-A --- Used for manual search between VFO-A frequency to VFO-B frequency

VFO-B --- Used for manual search between VFO-A frequency to VFO-B frequency

VFO-C --- Used to transfer frequency from the memory channel

VFO-D --- Used to transfer frequency from the search channel

VFO-E --- Used to receive frequency below 25 MHz while in dual frequency receive mode

The AR6000 has an auto mode setting, therefore, in most cases a proper receive mode and frequency steps are automatically selected.

3-5-1 TUNING FREQUENCY

3-5-1-1 ENTERING A FREQUENCY USING THE NUMERIC KEYPAD

While in VFO mode, enter the required frequency using MHz format followed by the [MHz] key.

(Example) Frequency entry of 81.3 MHz

Press the [8] key. Press the [1] key. Press the [.] key. Press the [3] key. Press the [MHz] key.



(Example) Frequency entry of 1134 kHz (1.134 MHz)

Press the [1] key. Press the [1] key. Press the [3] key. Press the [4] key. Press the [kHz] key.



Aborting frequency input

If you do not wish to complete the frequency data input, press the [CLR] key before completing the input sequence with the [MHz] key.

Correcting frequency input

Press the [UP] key to delete the entry from the right hand side.

3-5-1-2 CHANGING FREQUENCY USING THE MAIN DIAL

In VFO mode, the active VFO frequency may be 'tuned' in using the main dial which is mounted on the right side of the front panel. Rotate the dial 'clockwise' to increase frequency or turn 'counterclockwise' to decrease frequency.

3-5-1-3 CHANGING FREQUENCY USING [UP] KEY OR [DOWN] KEY

The [UP] and [DOWN] keys provide a convenient method to change the frequency.

The speed the receiver steps up or down depends on the step size which is set to default to auto. In auto mode, step size, receiver mode etc. are taken from the factory pre-programmed band plan but may be overridden at any time.

Press the **[UP]** key to tune the receiver upward in whichever step size is selected, use the **[DOWN]** key to tune the receiver downward in frequency.

3-6 RECEIVE MODE

Due to the necessities of signal bandwidth, channel occupancy and transmission efficiency, different receive modes are used by various services. The tuning step and receive mode are allocated by departments of Governments following international discussions so they are not consistent throughout the world. For this reason, it is necessary to change receive mode in order to monitor various transmissions.

For your convenience, receive mode and tuning step size have been pre-programmed into the AR6000 auto mode band plan data at the factory to simplify the operations of the receiver, especially while you familiarize yourself with the functions. If needed, the defaults may be manually overridden at anytime so that you may select an alternative receive mode and tuning step on any frequency.

AM – Amplitude Modulation

Used by broadcast services throughout the world on long wave, medium wave and shortwave. AM is also used by VHF airband, UHF military airband.

SAM – Synchronous AM

Helps to listen to SW (Shortwave) AM broadcast stations with fading signals.

FM – There are two common types of FM (Frequency Modulation):

NFM – Narrow Band Frequency Modulation

Provides high quality communication for relatively short distance operation.

FM uses a greater frequency bandwidth than other modes.

NFM is the most common mode used above 30 MHz with the exception of the airbands. NFM is widely used on the VHF bands: VHF marine band, 2m amateur band, 70 cm amateur band, PMR (Private Mobile Radio) and utilities.

In the absence of a signal, the background white noise may appear quite loud. For easier listening, the squelch control should be rotated clockwise until the background noise disappears; this should be carried out while no signal is present. The point at which the background noise is cancelled is known as the *threshold point*. Do not advance the squelch control more than necessary or the

receiver will appear to be desensitized and weaker signals will be missed.

WFM – Wide Band Frequency Modulation

Used by VHF and UHF broadcast stations as excellent audio quality.

This is available due to the relatively wide frequency bandwidth employed.

Used only for local services such as VHF band stereo channels.

LSB – Lower Side Band / A form of SSB (Single Side Band).

Not intended for commercial use, but extensively used by Radio Amateurs on frequencies below 10MHz.

This assists in the separation of Commercial and Amateur users on traditionally shared bands and prevents them from speaking to each other.

SSB is a very efficient method of transmission as the unwanted second sideband and carrier have been removed. This allows the full transmitter power to be employed in carrying useful information within the wanted sideband. As a result, greater distances are possible on SSB and a smaller frequency bandwidth is required than with most other modes.

USB – Upper Side Band

The same comments apply as for LSB. By convention, Radio amateurs also use USB above 10 MHz.

ISB – Independent Side Band

Similar to SSB, however, 2 independent SSB signals are transmitted on the same frequency.

Decoded signals can be heard separately from the headphone jack on the front panel.

CW - Continuous Wave

Also referred as Carrier Wave or Morse Code.

Commonly used on the short wave bands by radio amateurs toward the lower end of each band allocation. Some commercial use is still made by shipping etc, although its use is being phased out due to the introduction of automated stations.

AIQ – Analog IQ for DRM

New digital communication format for SW (Shortwave) broadcast.

Proper software and external hardware are required to decode DRM (not included).

3-6-1 AUTO MODE SELECTION

When in auto mode, the receive mode and tuning step size are automatically selected for you by the AR6000 microprocessor.

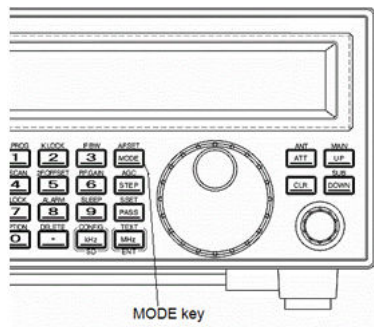

To activate auto mode or reconfirm its selection while in VFO mode, press and hold the **[MODE]** key for two seconds. “AUTO” will appear above the frequency portion of the LCD.



Note: Auto-mode is cancelled as soon as the receive mode, tuning step or other related data are changed. Remember that auto-STEP and auto-MODE are linked, reselect **AUTO MODE** if either have been adjusted and you require the auto band plan selection.

3-6-2 RECEIVE MODE SELECTION

Various receive modes may be selected for any frequency within the receiver’s frequency coverage. To access the receive mode menu, press the **[MODE]** key.



The following modes are available:

FM stereo, FM, NFM, SFM, WAM, AM, NAM, SAM, USB, LSB, CW, ISB, and AIQ.

Use the sub dial to select the desired mode. To accept the selection, press the **[MHz]** key.

3-7 CHANGING THE FREQUENCY STEP

The specification for channel occupancy, step (separation) and mode are decided by and allocated by the Departments of Governments following international discussions.

The allocation of frequency bands are not the same all over the world and channel separation (step) varies from band to band. As an example, the channel separation (step) for the MW (medium wave) band in the U.S.A. is 10 kHz, and is 9 kHz in Europe and Japan.

For above reasons, it is necessary to change the frequency step size according to the local band plan. The AR6000 has been pre-programmed at the factory with all the band plan data (specific to each market area) so that the AR6000 will automatically select the appropriate step size and mode for the frequency chosen. This greatly simplifies operation of the receiver while you are familiarizing yourself with all the functions.

The pre-programming of step size may be manually overridden so you may choose alternative settings at will or when band plans are updated.

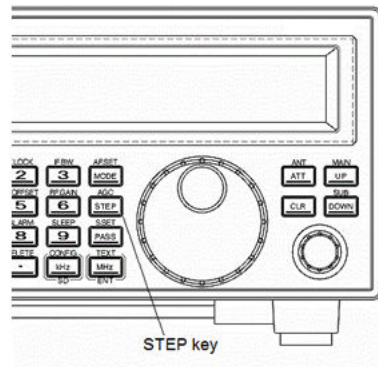

If you wish to change the default tuning frequency step, press the **[STEP]** key. The LCD will display the current frequency step and the blinking “STEP” while waiting for the new parameter. Use the sub dial to select the desired step.

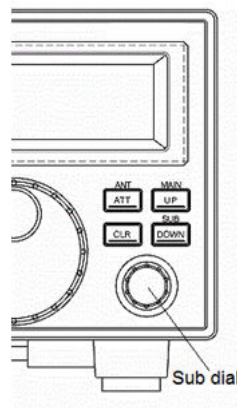

To accept the displayed tuning step size, press the **[MHz]** key.

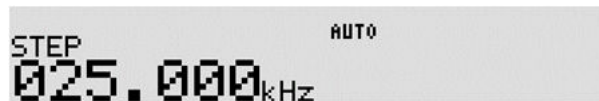

The tuning step size may also be programmed in 1 Hz (2 Hz over 3.15 GHz) (via the keypad) so that unusual step sizes other than those stated are possible. The acceptable step size range is less than 1 MHz in 1 Hz steps (or 2 Hz over 3.15 GHz).

3-8 IF BANDWIDTH

The IF bandwidth selects how SELECTIVE the receiver will be when monitoring signals off air. However, it is not simply a case of using the narrowest filter at all times; particular modes require differing amounts of bandwidth in order to operate. Otherwise the receive system will not produce intelligible sound.

Correct receive mode and IF bandwidth must always be selected for optimum reception. If the bandwidth selection is too narrow, distortion or signal break-up may occur. If the bandwidth selection is too wide, adjacent interference may be encountered. For this reason, a selection of IF filter bandwidths are provided as standard.

Typical examples of receive mode and IF bandwidth are:

- 200 kHz** – VHF FM broadcast
- 30 kHz, 100 kHz** – Wireless microphone, etc. (30 kHz for satellite FAX, too)
- 15 kHz** – PMR, amateur band, etc. FM 6 kHz may also be used
- 6 kHz** – VHF/UHF airband, short wave broadcast, medium & long wave, PMR, etc.
- 3 kHz** – Short wave amateur band, short wave utility, such as oceanic airband etc.
- 500 Hz** – Morse code used by radio amateurs and some marine traffic on short wave

An appropriate IF filter is automatically selected when auto mode is selected. However other combinations of IF filter and receive mode are possible in the manual mode. When you have manually selected an IF filter bandwidth, auto mode will be cancelled, but the receive mode, frequency step, etc will be retained until they are changed manually.

3-8-1 MANUALLY SELECTING IF BANDWIDTH

Press the [FUNC] key, and then press the [3] key.

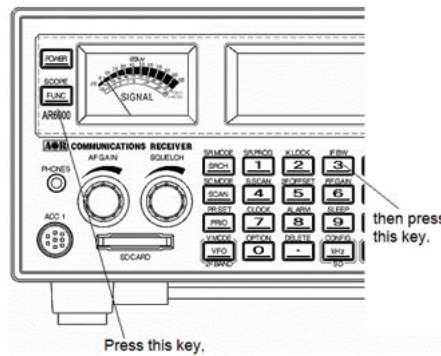

Select a new bandwidth from the list by rotating the sub dial. To accept the new bandwidth selection, press the [MHz] key.

Mode	Bandwidth	Remarks	Mode	Bandwidth	Remarks
WFM1 (IF100k)	100 kHz	N/A below 25 MHz	CW2 (200)	200 Hz	
WFM2 (IF 200k)	200 kHz	N/A below 25 MHz	AIQ (15 k)	15 kHz	
FMST (IF 200 k)	200 kHz	N/A below 25 MHz	FM	3, 6, 15, 30 kHz	N/A below 25 MHz
NFM (15 k)	15 kHz	N/A below 25 MHz	FMST	100, 200 kHz	N/A below 25 MHz
SFM (6 k)	6 kHz	N/A below 25 MHz	AM	3, 6, 15, 30 kHz	
WAM (15 kHz)	15 kHz	Wide AM	SAM	3, 6, 15, 30 kHz	
AM (6 k)	6 kHz		USB	3, 6, 15, 30 kHz	
NAM (3 k)	3 kHz	Narrow AM	LSB	3, 6, 15, 30 kHz	
SAM (6 k)	6 kHz	Synchronous AM	CW	500 Hz 200, 500 Hz	Below 25 MHz Above 25 MHz
USB (3 k)	3 kHz		AIQ	3, 6, 15, 30 kHz	
LSB (3 k)	3 kHz				
CW1 (500)	500 Hz				

4 ADDITIONAL SETTINGS

4-1 AGC (AUTOMATIC GAIN CONTROL)

To change the AGC parameter setting, press the [FUNC] key and then press the [STEP] key.

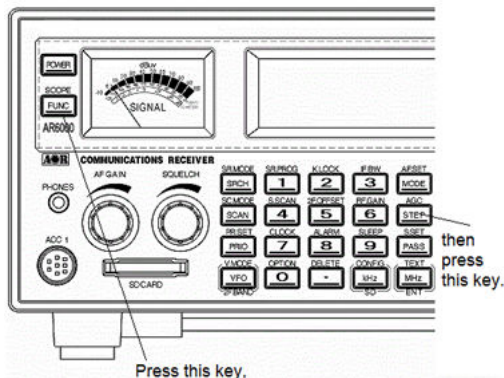

Select a new AGC parameter from the list of “FAST”, “MIDDLE”, “SLOW”, or “OFF (MANUAL)” by rotating the sub dial.

AGC: SLOW

To accept the new AGC parameter, press the [MHz] key.

Usually, **FAST** is used to receive CW, **MEDIUM** for AM and FM, and **SLOW** for SSB mode.

However, this option cannot be configured in FM mode.

When AGC is set to OFF, two horizontal bars are displayed on the LCD above “KHz” or “MHz”.



When AGC is set to OFF, the RF gain control can be adjusted.

4-2 ATTENUATOR / RF AMPLIFIER

Activating the attenuator reduces signal to the RF input stages of the AR6000 in order to prevent overloading due to connection to an external antenna or when the receiver is used close to strong transmissions.

The AR6000 has 5 settings for the attenuator, 0 dB (AMP), 0 dB, -10 dB, -20 dB, and AUTO.

To change the parameter setting, press the [ATT] key.



Select a new attenuator parameter from the list by rotating the sub dial. To accept the new parameter, press the [MHz] key.

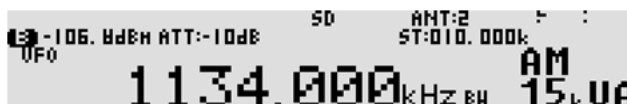

4-3 RF GAIN

Press the [FUNC] key, and press the [6] key to activate the manual RF gain control.

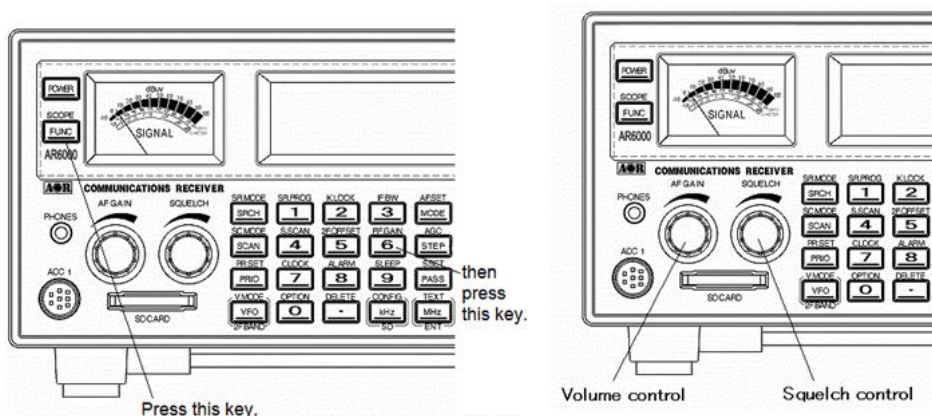

To change the RF gain manually, rotate the squelch knob. To cancel the manual RF gain control, repeat above steps.

Note: The manual RF gain control is not available while the receiver selects AGC mode.

4-4 ANTENNA INPUT

The AR6000 has two antenna input ports. However, a total of four antennas can be used with the optional antenna relay switch.

Press the [FUNC] key, and then press the [ATT] key to activate the antenna input selection menu.

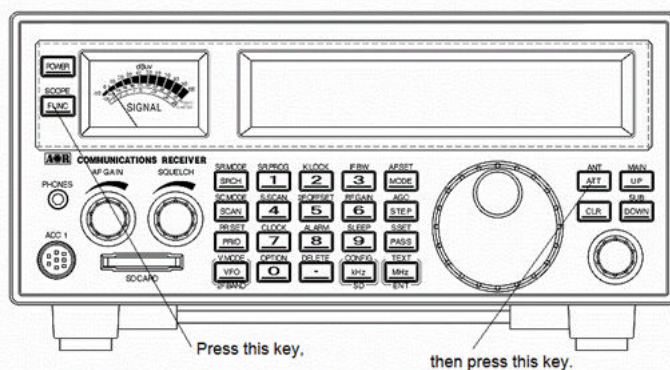

The menu has a selection of 1, 2, 3, 4, and PRG.

Rotate the sub dial to select the desired antenna input.



When PRG is selected and programmed, the antenna input will be automatically selected according to the receive frequency. If not programmed, the antenna 1 is selected.

4-5 KEYLOCK

Press the **[FUNC]** key, and press the **[2]** key to activate the key lock function.

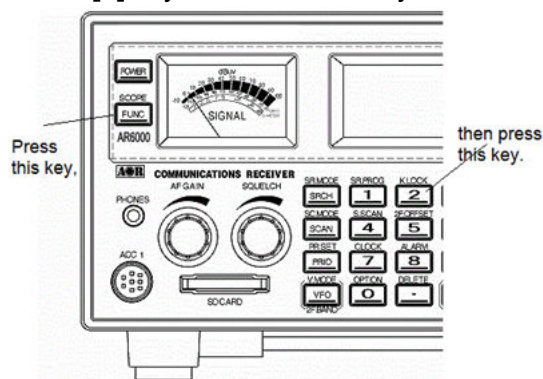

While activated, all front panel keys except the **[FUNC]** key, and **[POWER]** key are disabled to prevent accidental misoperation of the receiver. However, the volume and squelch controls remain operative.



5 ADVANCED FUNCTIONS

5-1 SPECTRUM DISPLAY

The AR6000 has a spectrum display function.

The frequency span can be selected between 0.4 MHz ~ 10 MHz.

5-1-1 ACTIVATING THE SPECTRUM DISPLAY

In VFO mode, press and hold the **[FUNC]** key for two seconds, then the spectrum display screen appears on the LCD.



Spectrum Display screen

5-1-2 CHANGING THE FREQUENCY SPAN

To change the frequency span, press the **[FUNC]** key, and then rotate the main dial. The new frequency span will be displayed on the bottom left on the LCD. To confirm entry, press the **[FUNC]** key again.

5-1-3 MOVING THE SPECTRUM

Rotate the main dial or sub dial to move the spectrum frequency. The current frequency will be displayed on the top middle on the LCD. However, the frequency marker will not change in this mode.

Note: The spectrum display function will be disabled while in dual band receive mode.

5-1-4 CHANGING THE MARKER FREQUENCY

To change the marker frequency, press the [CLR] key. A small square black box will appear on the top of the frequency marker. As you rotate the main dial or sub dial, the frequency cursor will move back and forth on the spectrum screen.

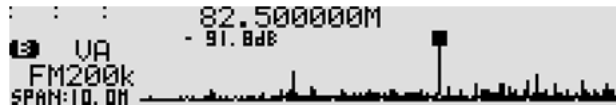

5-1-5 DEACTIVATING THE SPECTRUM DISPLAY

To exit from the spectrum display, press and hold the [FUNC] key for two seconds.

5-2 MULTI CHANNEL RECEIVE

The AR6000 is capable of monitoring of up to three channels simultaneously.

5-2-1 DUAL CHANNEL RECEIVE IN OFFSET MODE

In VFO mode, any two frequencies above 25 MHz, which are within +/- 5 MHz can be received simultaneously in offset mode with the following conditions.

1. Both frequencies must be above 25 MHz.
2. The frequency offset must be within +/- 5 MHz.
3. IF bandwidth must be less than 100 kHz.
4. The receive mode must be the same, and must not be WFM.

5-2-1-1 ACTIVATING DUAL CHANNEL IN OFFSET MODE

In VFO mode, press the [FUNC] key, then press the [5] key. The dual frequency display screen appears on the LCD.

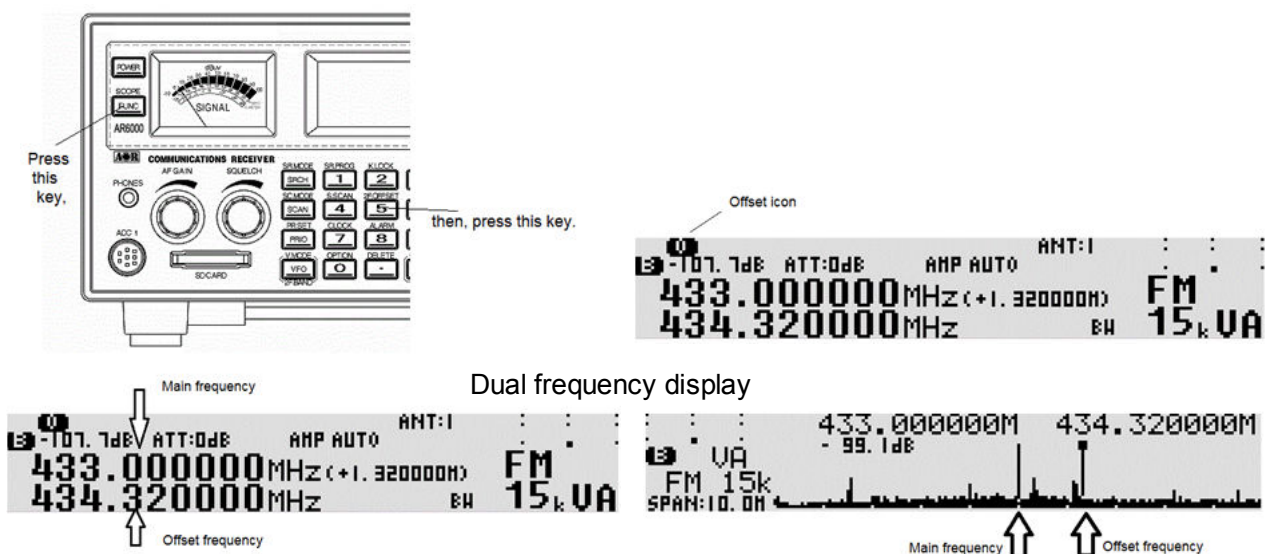

The offset frequencies can also be displayed in the spectrum display mode by pressing and holding the [FUNC] key for two seconds.

5-2-1-2 CHANGING THE OFFSET FREQUENCY

To change the offset frequency, rotate the sub dial. The frequency will change according to the step frequency of the sub dial.

5-2-1-3 CHANGING THE AUDIO BALANCE

Press the [FUNC] key, and then rotate the AF GAIN (Volume). The balance adjustment screen appears.

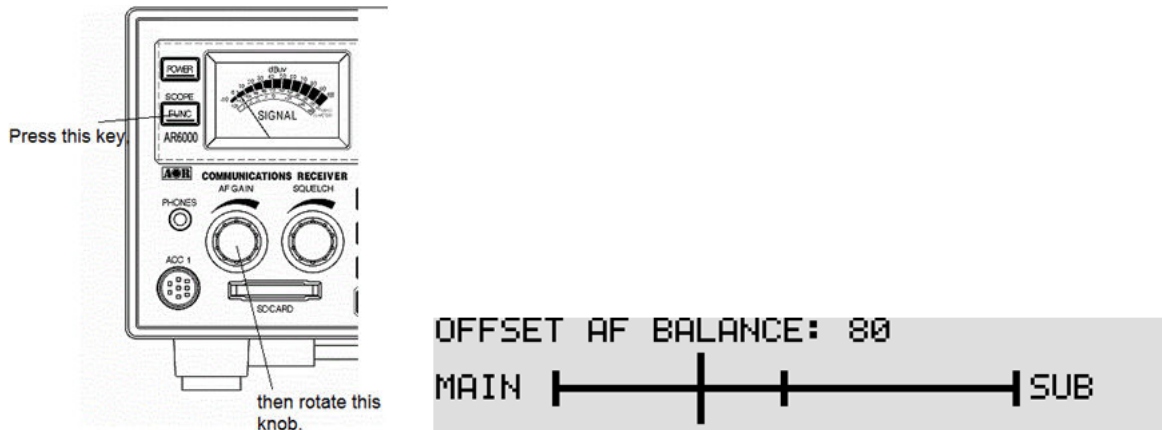

Rotate the AF gain (volume) to the desired audio level for both frequencies.

Press the [FUNC] key to accept setting.

5-2-1-4 DEACTIVATING DUAL CHANNEL RECEIVE

Press the [FUNC] key, then press the [5] key.

5-2-2 DUAL BAND RECEIVE

In VFO mode, one frequency below 25 MHz (defined as Sub frequency) and another frequency above 25 MHz (defined as Main frequency) can be received simultaneously.

5-2-2-1 ACTIVATING DUAL BAND RECEIVE

In VFO mode, press the [FUNC] key, and then press and hold the [VFO] key for two seconds. The dual band screen appears on the LCD.

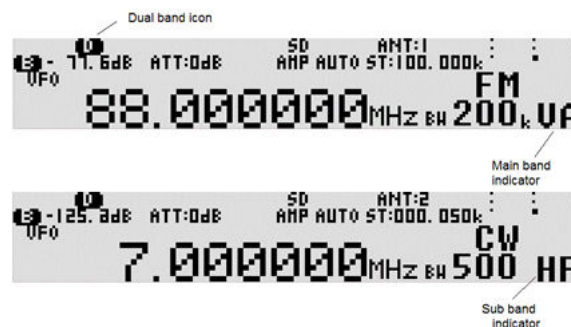

5-2-2-2 SETTING THE FREQUENCIES

To set the main frequency, press the [UP] key and enter the frequency using the numeric keypad.

To set the sub frequency, press the [DOWN] key and enter the frequency using the numeric keypad.

Note: The main frequency must be above 25 MHz, and the sub frequency must be below 25 MHz. However, separate modes can be selected for both frequencies.

5-2-2-3 CHANGING THE AUDIO BALANCE

Press the [FUNC] key, and then rotate the AF GAIN (Volume). Balance adjustment screen shown below appears.

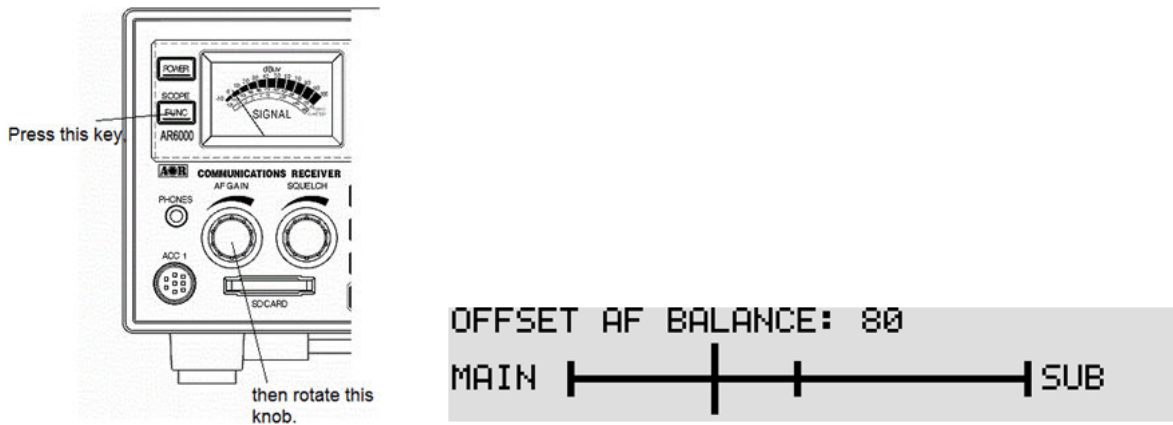

Rotate the AF gain (volume) to the desired audio level for both frequencies.

Press the [FUNC] key to accept setting.

5-2-2-4 DEACTIVATING DUAL BAND RECEIVE

Press the [FUNC] key, then press and hold the [VFO] key for two seconds.

5-2-3 TRIPLE CHANNEL RECEIVE

Using both the Dual channel receive mode and Dual band receive mode at the same time, a total of three channels can be received simultaneously.

5-2-3-1 SETTING FREQUENCIES

1. Set the first two frequencies by following the procedures for dual frequency receive in offset mode as described above. Those are used as the main frequencies.
2. Set the third frequency by following the procedures for dual band receive as described above. It is used as the sub frequency.
3. When all three frequencies are properly selected, both offset icon and dual band icon will appear on the LCD indicating the three frequencies have been stored successfully.

5-2-3-2 DEACTIVATING TRIPLE CHANNEL RECEIVE

1. Press the [FUNC] key, and then press the [5] key to exit dual frequency receive mode.
2. Press the [FUNC] key, and then press and hold the [VFO] key for 2 sec. to exit dual band mode.

5-3 MANAGING AN SD CARD

The AR6000 has a built-in SD memory card interface used for voice recording and/or memory management. Once formatted, all data on the card will be deleted and lost.

5-3-1 FORMAT AN SD CARD

The supplied SD card does not need to be formatted. However, if you wish to format the SD card, perform the following steps.

(Note: Once formatted, all data on the card will be deleted and lost.)

1. Insert a new SD memory card with a printed label upward facing, until you can hear a click.
2. Wait until “SD” appears on the top middle of the LCD.

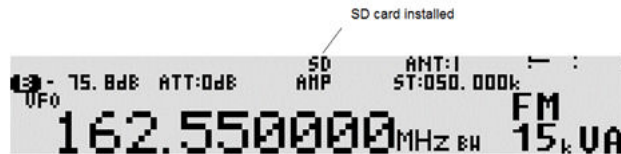

3. Press the [FUNC] key, and then press the [kHz] key. The configuration menu will be displayed.

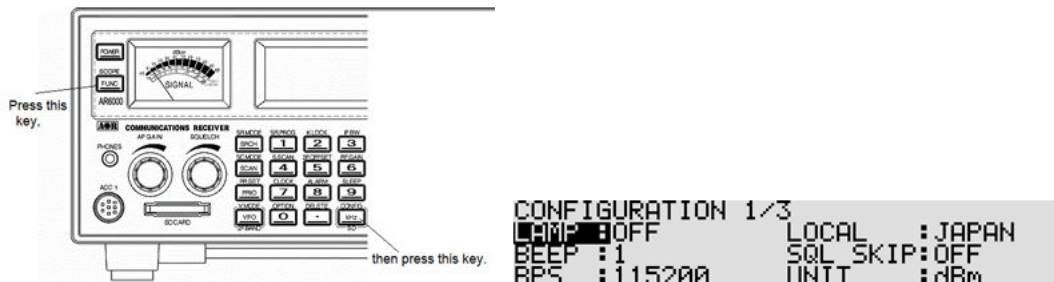

4. When the configuration menu is displayed, press the [UP] key four times to select “SD FORMAT” in reverse contrast.
5. Press the [MHz] key.



6. If you wish to proceed to format, press the [MHz] key.
To cancel formatting, press the [CLR] key.
7. Format will start.
8. Press the [CLR] key to exit the configuration menu.

5-3-2 SD CARD INFORMATION

1. Insert a SD memory card with the printed label upward facing the slot on the front panel until you

can hear a click.

2. Wait until "SD" appears on the top of the LCD.



3. Press the [FUNC] key, and then press the [kHz] key.

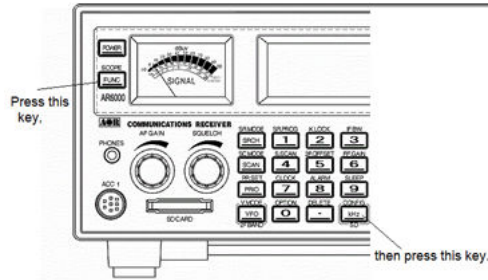

4. When the configuration menu is displayed, press the [UP] key seven times to select "SD INFO" in reverse contrast.
5. Press the [MHz] key. A sub screen will appear and the total available recording time and total size of the SD memory card information is displayed.



6. Press the [MHz] key to exit from this screen.
7. Press the [CLR] key to exit the configuration menu.

5-3-3 READ DATA FROM SD CARD

To read memory contents of the AR6000 on the SD memory card, perform the following steps:

1. Insert a SD memory card with a printed label upward facing the slot on the front panel until you can hear a click.
2. Wait until "SD" appears on the top of the LCD.

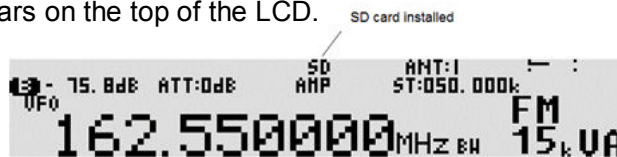

3. Press the [FUNC] key, and then press the [kHz] key.

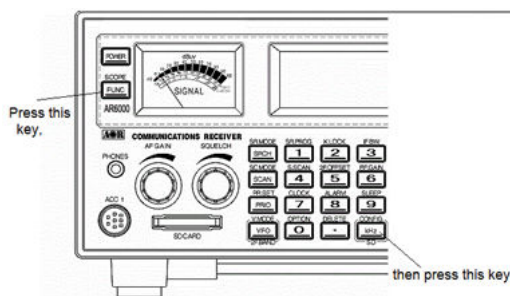

- When the configuration menu is displayed, press the [UP] key five times to select “READ FROM SD” in reverse contrast.
- Press the [MHz] key. The file list screen appears. (No file list will be displayed for the first time.)



- Use the [UP] key or [DOWN] key to select the file. To select the next page, rotate the sub dial.
- Press the [MHz] key. (An “SD CARD ERROR” message will be displayed if there is no file.)
- After reading from the file, the LCD will display the original screen.

5-3-4 WRITE DATA TO SD CARD

To write memory channel or search bank contents of the AR6000 to the SD memory card, perform the following steps:

- Insert a SD memory card with a printed label upward facing the slot on the front panel until you can hear a click.
- Wait until “SD” appears on the top of the LCD.

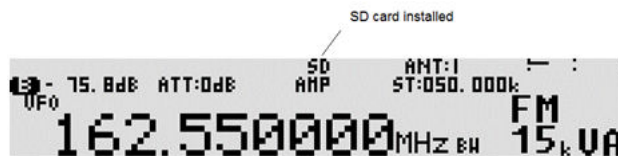

- Press the [FUNC] key, and then press the [kHz] key.

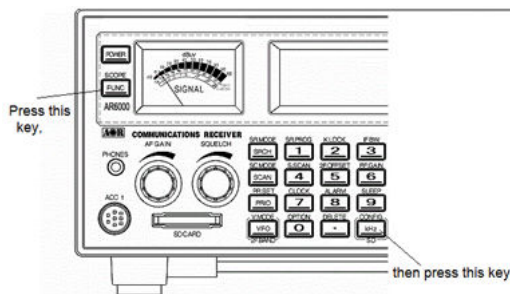

- When the configuration menu is displayed, press the [UP] key six times to select “WRITE TO SD” in reverse contrast.
- Press the [MHz] key.
- Using the numeric keypad, enter the desired file name. (No file extension required.)

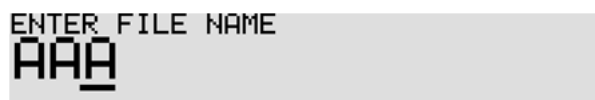

A text of up to eight characters can be assigned to each file name.
Each numeric keypad is assigned to have the following characters:

Key Characters

1	SPACE	
2	1	
3	A	(Example) To select "B", press the [3] key, then rotate
4	M	the sub dial clockwise.
5	Z	
6	9	
0	-	

To move the cursor, press the [DOWN] key to the left, [UP] key to the right.

7. To confirm entry, press the [MHz] key.



8. When it is completed, the LCD will display the original screen.

5-3-5 RECORDING AUDIO

Received audio can be recorded on the SD memory card. To record audio, perform the following steps:

1. Insert a SD memory card with a printed label upward facing the slot on the front panel until you can hear a click.
2. Wait until "SD" appears on the top of the LCD.

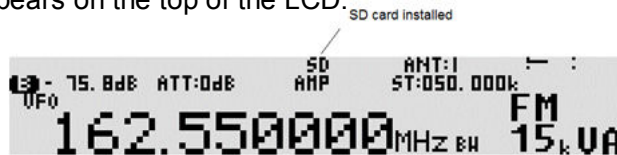

3. Press and hold the [kHz] key for two seconds. Recording will start and the "SD" icon will change to "REC".
4. To stop recording, press the [CLR] key and wait for 2 ~ 3 seconds. The "REC" icon will change to "SD" and recorded audio file name will be automatically assigned.
5. To change the file name, press and hold the [MHz] key for two seconds. The file name screen will appear.



6. A text of up to eight characters can be assigned to each file name.
Each numeric keypad is assigned to have the following characters:

Key Characters

- 1 SPACE
- 2 1
- 3 A (Example) To select "B", press the [3] key, then rotate the sub dial clockwise.
- 4 M
- 5 Z
- 6 9
- 0 -

To move the cursor, press the [DOWN] key to the left, [UP] key to the right.

7. To confirm entry, press the [CLR] key.

5-3-6 PLAYBACK AUDIO

To playback a recorded audio, perform the following steps:

1. Insert a SD memory card with a printed label upward facing the slot on the front panel until you can hear a click.

2. Wait until "SD" appears on the top of the LCD.



3. Press the [kHz] key. The file name screen will appear.



4. Use the [UP] key or [DOWN] key to select the file. To select the next page, rotate the sub dial.
5. Press the [MHz] key to playback audio.
6. To stop, press any key.

5-3-7 DELETE FILES

To delete a recorded audio file on the SD memory card, perform the following steps:

1. Insert a SD memory card with a printed label upward facing the slot on the front panel until you can hear a click.

2. Wait until "SD" appears on the top of the LCD.

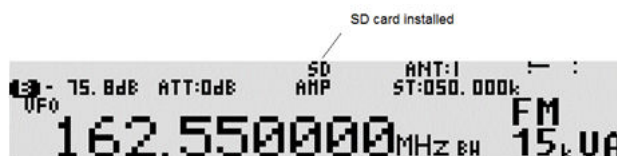

3. Press the [kHz] key. The file name screen will appear.

File name	Recording time	Recorded date and time
00000004. WAV	00:00:04. 6	2080/00/30 15:56:56
00000005. WAV	00:00:02. 7	2080/00/30 15:58:22
00000006. WAV	00:01:59. 3	2080/00/30 15:59:46
00000007. WAV	00:00:26. 0	2080/00/30 16:10:44

4. Use the [UP] key or [DOWN] key to select the file. To select the next page, rotate the sub dial.
5. Press the [FUNC] key, and then press [.] (period) key.
6. To delete the file, press the [MHZ] key. To cancel, press the [CLR] key.

6 MEMORY CHANNELS AND BANKS

It is convenient to store commonly used frequencies into a memory channel along with mode etc, as this saves having to key the data in over and over again. Memory read is very straightforward and quick when compared to retyping all data.

6-1 MEMORY CHANNEL OVERVIEW

Think of memory channels as pages in a notebook each of which is numbered to identify it. Data may be written to each new page (memory channel) and each page may be overwritten with new data, so they can be used over and over again. The AR6000 has **2,000 memory channels** and one **priority channel**.

Each memory channel may hold:

- **One receive frequency**
- **Receive mode**
- **Tuning step**
- **Frequency step adjust**
- **Attenuator setting**
- **Text comment of up to twelve characters**
- **De-emphasis**
- **Antenna input**
- **AGC mode**
- **CTCSS**
- **DCS**
- **Auto notch**

The alphanumeric comment may be used to ease identification at a later date. The 2,000 memory channels are divided into 40 banks, and each bank has 50 channels. The memory banks are identified by the first **BANK** number 0, 1, 2, 3, ..., 38, 39 and the individual channels are numbered from 00 to 49.

(Example): "1234" is the location: memory bank "12" and memory channel "34"

The data contents of memory and search banks are held in an EEPROM so that no backup battery is required for memory retention.

The stored data may be quickly and easily recalled, changed or deleted using the memory recall and delete functions.

Note: When the receiver is switched OFF, all VFO data will be automatically stored into EEPROM memory storage.

6-2 STORING VFO FREQUENCIES AND DATA INTO MEMORY

The process to save a displayed VFO frequency to memory is as follows:

1. In VFO mode, select the required frequency, mode, attenuator etc.
2. Press and hold the **[MHz]** key for two seconds. The AR6000 will automatically find the next available vacant memory channel.
3. Using the keypad, select the desired memory location (bank and channel).
4. Add a text comment (optional) or delete an existing comment.
5. Press the **[MHz]** key to exit the menu and save the data to the specified memory location.

(Example) Storing the frequency of 123.500 MHz into memory bank “**3**” location “**25**” (0325) while in VFO mode with the text comment of “**AIRBAND**”.

If a mistake is made during programming, press the **[CLR]** key to abort entry and return to VFO mode.

1. Start by selecting VFO mode, then enter the frequency of 123.500 MHz, “mode and step size” are set to the default auto mode.
 - a) Press the **[VFO]** key to set the AR6000 into the VFO mode.
 - b) Press the **[1]** key.
 - c) Press the **[2]** key.
 - d) Press the **[3]** key.
 - e) Press the **[.]** (decimal) key.
 - f) Press the **[5]** key.
 - g) Press the **[MHz]** key.
2. Press and hold the **[MHz]** key for two seconds to find the next available vacant memory channel.
3. Using the numeric keypad,
 - a) Press the **[0]** key.
 - b) Press the **[3]** key.
 - c) Press the **[2]** key.
 - d) Press the **[5]** key,

to store the frequency into the location. (memory bank 03, channel number 25.)

When the [----.-----] is displayed on the right bottom of the LCD, the selected channel is vacant.

```
123.500000MHz
MEM SET      UFO COPY(Press[.])
BANK: 3
CH  :25      ----.-----
```

(To change the memory bank, rotate the sub dial. To change the memory channel, rotate the main dial.)

4. Press the [MHz] key.

5. Add the text comment "AIRBAND"

Key Characters

1 SPACE

2 1

3 A (Example) To select "B", press the [3] key, then rotate

4 M the sub dial clockwise.

5 Z

6 9

0 -

- a) To enter "A", press the [3] key.
- b) Press the [DOWN] key to move the cursor to the right.
- c) Press the [3] key. Rotate the sub dial to select "1".
- d) Press the [DOWN] key.
- e) Press the [4] key.
- f) Rotate the sub dial to select "R".
- g) Press the [DOWN] key.
- h) Press the [3] key.
- i) Rotate the sub dial to select "B".
- j) Press the [DOWN] key.
- k) Press the [3] key. ("A" appears.)
- l) Press the [DOWN] key.
- m) Press the [4] key.
- n) Rotate the sub dial to select "N".
- o) Press the [DOWN] key.
- p) Press the [3] key.
- q) Rotate the sub key to select "D".

7. Press the [MHz] key to confirm entry.

A maximum of 12 characters may be added to each memory channel.

6-3 MEMORY READ

Once frequency and mode data have been stored into a memory location, retrieval is quick and simple. Let's assume that you are going to retrieve the frequency of 123.500 MHz which has been programmed into memory "0325" during an earlier example in the preceding section of this manual.

1. In VFO mode, press the [**SCAN**] key to go into memory read mode.
2. Rotate the sub dial to select the memory bank "03" displayed on the right bottom of the LCD.
3. Rotate the main dial to select the memory channel "25" displayed on the right bottom of the LCD.
4. The memory frequency of 123.500 MHz will be displayed on the LCD.



5. If you already know the memory bank and memory channel, simply press the [**0**],[**3**],[**2**],[**5**] key.
6. The AR6000 will monitor whatever memory channel you enter into memory read.
7. To return to VFO mode, press the [**VFO**] key.

6-4 DELETE MEMORY CHANNEL

To delete the contents of a single memory channel, perform the following steps.

1. In memory read mode, press the [**FUNC**] key, and then press the [. (decimal)] key.
2. The memory delete menu will appear and blink.

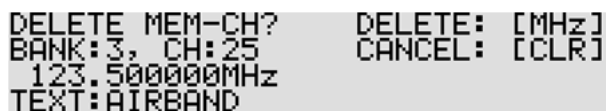

3. If you wish to delete this memory channel contents, press the [**MHz**] key.
4. To cancel, press the [**CLR**] key.

6-5 DELETE ALL MEMORY CHANNELS IN THE MEMORY BANK

To delete the contents of an entire memory channel in the memory bank, perform the following steps:

1. In memory read mode, press the [**FUNC**] key, and then press and hold the [. (decimal)] key for two seconds.
2. The following delete menu will appear with "DEL MEM-CH" in reverse contrast.



3. Rotate the sub dial to select the memory bank to delete.
4. When the selected bank has registered memory channels, "***" will be displayed on the bottom right corner of the LCD. If the selected memory bank has no registered channel, "- -" will appear.
5. To delete, press the [**PASS**] key. To cancel, press the [**CLR**] key.
6. Press the [**MHz**] key to exit from this menu.

7 SCAN – SCANNING MEMORY CHANNELS

The AR6000 has a scan mode whereby the contents stored in the memory channels are automatically recalled and monitored very quickly for activity – scanned.

*Note: It is important that you do not confuse **SCAN** and **SEARCH** modes.*

SEARCH mode (covered later in this manual) automatically tunes the receiver through all frequencies between two specified frequency limits looking for active frequencies.

7-1 SCAN – OUTLINE INTRODUCTION

During scan, the AR6000 automatically recalls memory channels which contain data in numeric order and monitors looking for activity. When an ‘active’ memory channel is located (when a signal is found and the squelch is open), the AR6000 will temporarily stop scanning.

7-2 STARTING SCAN

Presuming that some memory channels are programmed with data, start the scan process with one press of the [SCAN] key. The “SCAN” is displayed on the middle left of the LCD to indicate that the scan process has been started, a bank number will also be displayed representing the current bank.

Ensure that the squelch is set to threshold point so that background noise is cancelled and the squelch closes (otherwise scan will not operate).

When scan has been selected, only the currently displayed memory bank which contains data will be scanned, and receive mode and frequency are not important. Any memory channels which contain no data (empty) will be ignored and skipped.

7-3 SELECTING A SCAN BANK

The memory bank identifier (such as “03”) will be displayed on the middle right of the LCD.



If more than one memory channel is programmed into the current memory bank, and when an ‘active’ channel has been located (busy, so the squelch opens), the scan process will temporarily pause on the active channel. The memory location (such as “25”) will be displayed along with any accompanying text.

To select another memory bank for scanning, rotate the sub dial or enter the two digits of the memory bank number from the numeric keypad.

To exit from scan mode, press the [VFO] key.

7-4 DISPLAYING A MEMORY CHANNEL TEXT

To display a memory channel text, press the **[FUNC]** key and then press the **[MHz]** key.

Each time the above step is performed, the display contents change as follows:

- 
1. Text only
 2. Text and frequency
 3. Frequency only (normal display)

7-5 SELECT SCAN

Select scan enables you to ‘tag’ memory channels to make a temporary list up to 100 channels in the same memory bank for scanning in a separate list called the select scan list. The selected memory channels in the select scan list will be received even though they are set to be passed (skipped).

7-5-1 ADDING SELECT SCAN CHANNELS IN MEMORY READ MODE

In memory read mode, press the **[FUNC]** key, and then press the **[PASS]** key to toggle the select scan tag on/off. “S” appears on the left of the memory bank of the LCD.

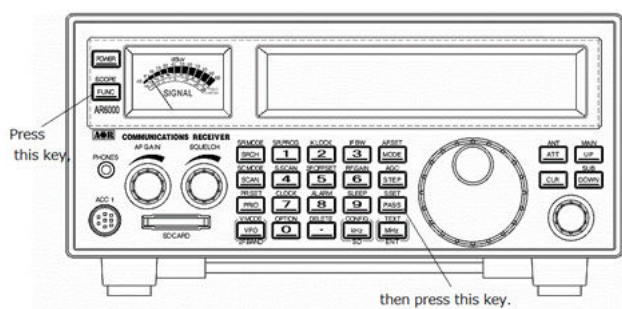

7-5-2 DELETE SELECT SCAN CHANNELS IN MEMORY READ MODE

To delete all selected scan channels, perform the following steps:

1. Press the **[FUNC]** key, and then press and hold the **[.]** (period) key for two seconds.
2. The following delete menu will appear with “DEL MEM-CH” in reverse contrast.

```
DEL MEM-CH DEL F-PASS BANK
DEL SEL-CH   00
DEL M-PASS   **
DEL SRCH
```

3. Press the **[DOWN]** key to move the cursor downward. Select “DEL SEL-CH” in reverse contrast.
4. When the select scan memory has registered channels, “**” will be displayed on the bottom right corner of the LCD. If there is no registered channel, “-” will appear.

```
DEL MEM-CH DEL F-PASS BANK
DEL SEL-CH   **
DEL M-PASS
DEL SRCH
```

5. To delete all selected scan channels, press the **[PASS]** key. To cancel, press the **[CLR]** key.

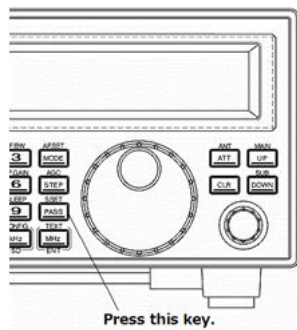

6. Press the **[MHz]** key to exit from this menu.

7-5-3 STARTING / STOPPING SELECT SCAN

To start select scan, you must first have at least two memory channels tagged for select scan.

Press the **[FUNC]** key, and then press the **[4]** key to start select scan.

The direction of the scan can be reversed using the sub dial.



To stop select scan, press the **[VFO]** key.

7-6 LOCKING OUT UNWANTED ACTIVE MEMORY CHANNELS (PASS)

It is possible to lock out (PASS) unwanted memory channels while in scan mode. This is useful to eliminate unwanted permanent transmissions. It is important to understand the PASS function before taking action or transmissions may be missed.

In memory read mode or while stopped on an unwanted frequency, press the **[PASS]** key.

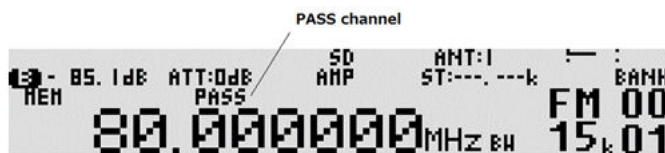
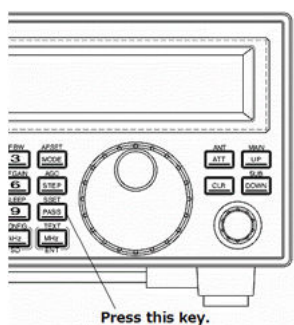

Pressing the **[PASS]** key again on the same memory channel will de-select pass channel.

The scan process will resume. It will appear that all channels are still scanned, however, locked out channels will be 'skipped', the scan will not stop on locked out channels.

7-6-1 DELETE ALL PASS CHANNELS

To delete all pass channels in a memory bank, perform the following steps:

1. Press the **[FUNC]** key, and then press and hold the **[.]** (period) key for two seconds.
2. The following delete menu will appear with "DEL MEM-CH" in reverse contrast.

```

DEL MEM-CH DEL F-PASS BANK
DEL SEL-CH      00
DEL M-PASS     **
DEL SRCH
  
```

3. Press the **[DOWN]** key to move the cursor downward. Select "DEL M-PASS" in reverse contrast.

```

DEL MEM-CH DEL F-PASS BANK
DEL SEL-CH      00
DEL M-PASS     **
DEL SRCH
  
```

4. Rotate the sub dial to select the memory bank. When the pass channel memory has registered channels, "***" will be displayed on the bottom right corner of the LCD. If there is no registered channel, "- -" will appear.

5. Press the **[PASS]** key.

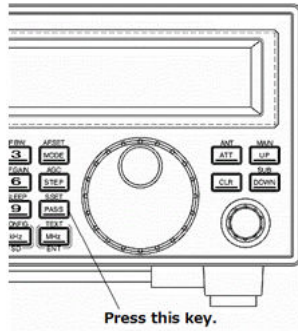

6. Press the **[MHz]** to exit from this menu.

7-7 SCAN GROUP

The AR6000 has 20 scan groups to be used with the bank link function and other functions.

The following parameters can be registered for each of the scan groups.

- Bank link setting
- Scan pause
- Scan delay
- Voice scan
- Mode scan

7-7-1 BANK LINK SETTING

To activate the bank link function, perform the following steps:

1. Press the **[FUNC]** key, and then press the **[SCAN]** key. The bank link screen will appear.

```

→ -- -- -- -- -- -- -- -- -- -- SCAN GRP: 0
-- -- -- -- -- -- -- -- -- -- LINK: OFF
-- -- -- -- -- -- -- -- -- --
  
```

2. Rotate the sub dial to select the bank link group. Pressing the **[PASS]** key will toggle the link on/off.

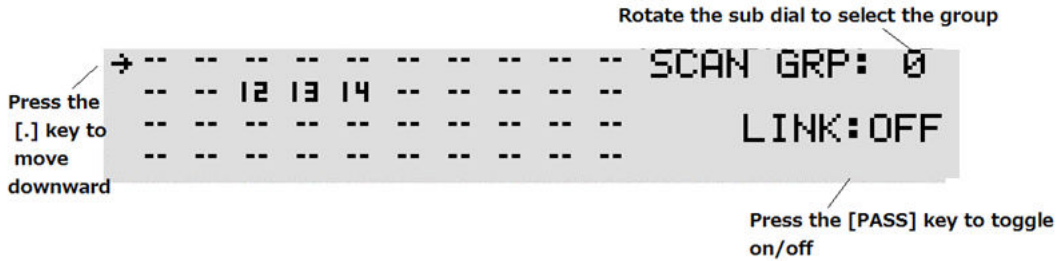

3. To select the memory bank to be linked, enter the memory bank number using the numeric keypad. If the memory bank is between 10 ~ 19, press the [.] key to move the cursor to the second row and enter only the first digit of the memory bank number from the numeric keypad. (Example: If the memory bank is 12, enter "2".)
4. Press the [MHz] key to complete setting.

7-7-2 SCAN PAUSE

The scan pause parameter determines how long the receiver will remain on an active channel before resuming scanning even if the channel is still busy. Scan pause helps keep you from having to manually intervene to force the scan to continue or use channel lockout (pass).

The parameter ranges are off and 1 to 60 seconds. When the parameter is set to off, the receiver remains on the busy channel until the received signal disappears or the memory channel is changed.

To set the scan pause parameter, perform the following steps:

1. Press the [FUNC] key, and then press the [SCAN] key. The bank link screen will appear.



2. Select the bank link group number, and then press the [DOWN] key. The pause setting screen will appear.

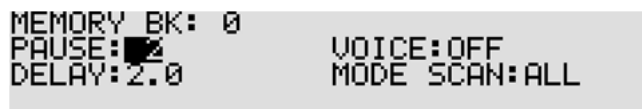

3. Rotate the sub dial to set scan pause parameter (between 1 ~ 60 or off). To set scan pause to off (zero), press the [PASS] key or enter "0" from the numeric keypad.
4. To confirm entry, press the [MHz] key. To set other parameters, press the [DOWN] key.

7-7-3 SCAN DELAY

The scan delay parameter affects the time the AR6000 will remain on an active channel in the scan mode once the received signal has disappeared and the squelch is closed. This is particularly useful for customizing how long the receiver will wait for a reply before continuing to scan.

The parameter ranges are off, hold and 0.1 to 9.9 seconds.

To set the scan delay parameter, perform the following steps:

1. Press the **[FUNC]** key, and then press the **[SCAN]** key. The bank link screen will appear.

```

→ -- -- -- -- -- -- -- -- -- -- SCAN GRP: 0
-- -- -- -- -- -- -- -- -- --
-- -- -- -- -- -- -- -- -- -- LINK: OFF
-- -- -- -- -- -- -- -- -- --
  
```

2. Select the bank link group number, and then press the **[DOWN]** key. The pause setting screen will appear.

```

MEMORY BK: 0
PAUSE: 2
DELAY: 2.0
VOICE: OFF
MODE SCAN: ALL
  
```

3. Press the **[DOWN]** key again.
4. Rotate the sub dial to select the scan delay. If “hold” is selected, the receiver will stop scanning when the signal is received until either the **[UP]** key, or **[DOWN]** key is pressed.

```

MEMORY BK: 0
PAUSE: 2
DELAY: 2.0
VOICE: OFF
MODE SCAN: ALL
  
```

5. To confirm entry, press the **[MHz]** key. To set other parameters, press the **[DOWN]** key.

7-7-4 VOICE SCAN

When the voice scan function is activated, the scan process will stop only on active channels which have modulation (such as voice) present. The AR6000 will not remain on unmodulated channels (such as blank carriers). The parameter ranges are off, and 1 ~ 7.

To set the voice scan parameter, perform the following steps:

1. Press the **[FUNC]** key, and then press the **[SCAN]** key. The bank link screen will appear.

```

→ -- -- -- -- -- -- -- -- -- -- MEMORY BK: 0
-- -- -- -- -- -- -- -- -- --
-- -- -- -- -- -- -- -- -- -- LINK: OFF
-- -- -- -- -- -- -- -- -- --
  
```

2. Select the bank link group number, and then press the **[DOWN]** key.
The pause setting screen will appear.

```

MEMORY BK: 0
PAUSE: 2
DELAY: 2.0
VOICE: OFF
MODE SCAN: ALL
  
```

3. Press the **[DOWN]** key twice to select “VOICE:” parameter in reverse contrast.

```

MEMORY BK: 0
PAUSE: 2
DELAY: 2.0
VOICE: ON
MODE SCAN: ALL
  
```

4. Rotate the sub dial to set voice scan parameter (between 1 ~ 7 or off). To set scan pause to off, press the **[PASS]** key or enter “0” from the numeric keypad.
5. To confirm entry, press the **[MHz]** key. To set other parameters, press the **[DOWN]** key.

7-7-5 MODE SCAN

The mode scan parameter determines whether all specified memory channels will be scanned or only those of a certain receive mode.

This function can be very useful if, for example, you have a mixture of VHF AM airband frequencies in a memory bank along with VHF NFM marine. Rather than having to scan all channels or lockout (pass) certain channels, a specific receive mode only can be quickly selected and scanned.

To set the mode scan parameter, perform the following steps:

1. Press the **[FUNC]** key, and then press the **[SCAN]** key. The bank link screen will appear.

```

→ -- -- -- -- -- -- -- -- -- -- SCAN GRP: 0
-- -- -- -- -- -- -- -- -- --
-- -- -- -- -- -- -- -- -- -- LINK: OFF
-- -- -- -- -- -- -- -- -- --

```

2. Select the bank link group number, and then press the **[DOWN]** key.

The pause setting screen will appear.

```

MEMORY BK: 0
PAUSE: 2
DELAY: 2.0
VOICE: OFF
MODE SCAN: ALL

```

3. Press the **[DOWN]** key three times to select “MODE SCAN:” parameter in reverse contrast.

```

MEMORY BK: 0
PAUSE: 2
DELAY: 2.0
VOICE: 3
MODE SCAN: [ ]

```

4. Rotate the sub dial to select voice scan parameter.
5. To confirm entry, press the **[MHz]** key. To set other parameters, press the **[DOWN]** key.

8 SEARCH MODE

In search mode, the AR6000 is programmed to automatically tune between two specified frequency limits looking for activity.

Before activating search mode, the squelch must be set to threshold where the background noise disappears.

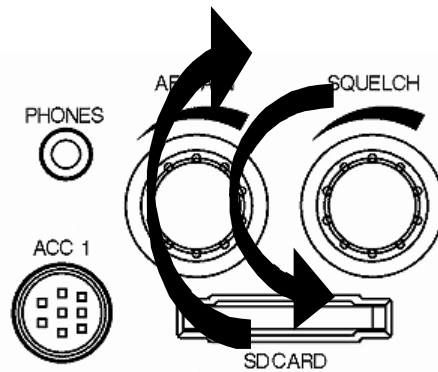

8-1 SEARCH TYPE

The AR6000 is equipped with VFO search, program search, and Cyber search.

VFO SEARCH = Search between two VFO frequencies

PROGRAM SEARCH = Search between user preprogrammed frequency limits

CYBER SEARCH = Ultra high speed search

8-1-1 VFO SEARCH

The VFO search is the easiest way of searching without programming.

When the VFO-A is selected as a primary VFO, the AR6000 will search between two frequencies on VFO-A and VFO-B with receive mode, frequency step set in the VFO-A.

When the VFO-C, VFO-D, or VFO-E are selected, the AR6000 will search between those frequencies to the upper limit (6 GHz) or the lower limit (9 kHz) frequency.

To activate the VFO search, perform the following steps:

1. In VFO mode, press and hold either the **[VFO]** key, **[UP]** key, or **[DOWN]** key for two seconds. The search process starts. The search direction can be changed by rotating the main dial or pressing the **[UP]** key or **[DOWN]** key.



2. When the receiver stops on a busy frequency, you can resume manual search by rotating the main dial or pressing the **[UP]** key or **[DOWN]** key.
3. While the receiver stops on receive signal, pressing the **[PASS]** key will register the receive frequency to the VFO pass frequencies. This frequency will be locked out (passed) after the next search and not be received.
4. While the receiver stops on receive signal, pressing the **[MHz]** key will transfer the receive frequency to the VFO-D and quit searching.
5. To stop the manual search, press the **[VFO]** key.

8-1-2 PROGRAM SEARCH

The AR6000 has 20 program search banks (referred to simply as search banks) which can be programmed with specific parameters:

- LO (lower) start frequency
- HI (upper) stop frequency
- Receive mode (or set to AUTO MODE)
- Text comment

The program search banks are identified by numbers (00 ~ 19). To help with identification, each bank may be labeled with an alphanumeric text comment.

8-1-2-1 STARTING PROGRAM SEARCH

Presuming that data is already stored into a search bank.

Press the [SRCH] key to start the program search process.



“SR” icon will be displayed on the right bottom of the LCD. As long as the squelch is closed, the search process will start from the lower frequency limit and will progress toward the upper frequency limit. When the program limit is reached, the search loops around and starts the process again.

Note: If no search banks have been programmed, the search will not operate.

8-1-2-2 REVERSING THE SEARCH DIRECTION

To reverse the search direction, rotate the main tuning dial or press the [UP] key or [DOWN] key.

This is useful to enable you to search back over an interesting point of the search process.

8-1-2-3 FORCING THE SEARCH TO RESUME

If the AR6000 stops on an unwanted busy frequency, rotate the main tuning dial knob or press the [UP] key or [DOWN] key to force the search process to resume from the current frequency displayed.

8-1-2-4 STOPPING THE SEARCH

While the search process is in progress (not stopped), press the [VFO] key (displaying the data on-screen before search was started).

8-1-2-5 SELECTION OF SEARCH BANK

There are 20 search banks. While searching, rotate the sub dial to step through search banks which contain data. If no data is programmed in the nominated search bank, the next bank containing valid data will be used.

8-1-2-6 PROGRAMMING A SEARCH BANK

Each of the 20 search banks may be programmed with different frequency limits, receive modes, etc.

To program a search bank, perform the following steps:

1. Press the **[FUNC]** key, and then press the **[1]** key to access the search program menu.

```
BANK: 1
LO: ----.-----
HI: ----.-----
MODE: AUTO
IFB: 200
STEP: ---.---k
TEXT: No Data
```

2. Rotate the sub dial to select the search bank to program or overwrite.

```
BANK: 3
LO: ----.-----
HI: ----.-----
MODE: AUTO
IFB: 15k
STEP: ---.---k
TEXT: No Data
```

3. Press the **[DOWN]** key to move the cursor downward. Using the numeric keypad, enter the lower frequency limit in MHz format. After an entry of the frequency, the cursor will automatically move downward.

```
BANK: 3
LO: 0144.000000
HI: ----.-----
MODE: AUTO
IFB: 15k
STEP: ---.---k
TEXT: No Data
```

4. Using the numeric keypad, enter the upper frequency limit in MHz format. After an entry of the frequency, the cursor will automatically move downward.

```
BANK: 3
LO: 0144.000000
HI: 0148.000000
MODE: AUTO
IFB: 15k
STEP: ---.---k
TEXT: No Data
```

5. Rotate the sub dial to select the receive mode. If "AUTO" is selected, the IF bandwidth and frequency step will be entered automatically.
6. If you selected other than auto mode, press the **[DOWN]** key and enter the IF bandwidth and frequency step manually.
7. Press the **[DOWN]** key to enter the search text.

8. For example, enter **No Data** as search bank text.

```
SEARCH BANK: 3
No Data
[UP,DOWN] <->
[SUB Dial] ↓
[1]' ', [3]'A'
[2]'1', [0]'-'
```

"2M BAND" as a

To enter "2", press the **[2]** key and rotate the sub dial clockwise for one click.

Then press the **[UP]** key.

To enter "M", press the **[4]** key and then press the **[UP]** key.

To enter " " (space), press the **[1]** key and then press the **[UP]** key.

To enter "B", press the **[3]** key and rotate the sub dial clockwise for 1 click.

Then press the **[UP]** key.

To enter "A", press the **[3]** key and then press the **[UP]** key.

To enter “N”, press the [4] key and rotate the sub dial clockwise for 1 click.

Then press the [UP] key.

To enter “D”, press the [3] key and rotate the sub dial clockwise for 3 clicks.

To accept data entry, press the [MHz] key.



[Key assignment for text input]

[1]: “ ” (space) [2]: “1” [3]: “A” [4]: “M” [5]: “Z” [6]: “9” [0]: “-“

(Example: Press the [3] key and rotate the sub dial clockwise.

The character will change as A → B → C → D ----.)

[UP] key: Move the cursor rightward [DOWN] key: Move the cursor leftward

[PASS] key: Delete this character

8-1-2-7 DELETING SEARCH BANKS

A delete menu is provided so that you can delete program search data (of course you may simply overwrite the data, too).

To delete search bank, perform the following steps:

1. Press the [FUNC] key, and then press and hold the [.] key for two seconds.

The following delete menu will appear with the “DEL MEM-CH” in reverse contrast.

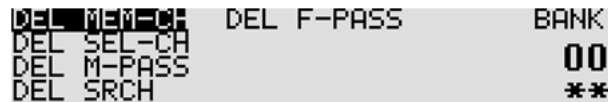

2. Press the [DOWN] key to move the cursor downward. Select “DEL SRCH” in reverse contrast.

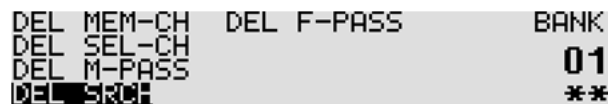

3. Rotate the sub dial to select the search bank. When the search bank has registered frequencies, “**” will be displayed on the bottom right corner of the LCD. If there is no registered frequency, “- -“ will appear. When “v” is appeared on the bank number, then it indicates the VFO search pass frequencies.

4. Press the [PASS] key to delete.

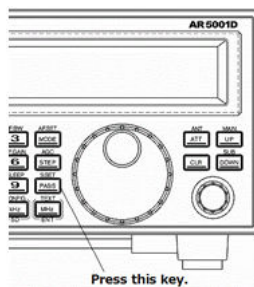

5. Press the [MHz] to exit from this menu.

8-1-2-8 LOCKING OUT UNWANTED ACTIVE FREQUENCIES (PASS)

It is possible to lock out (pass) unwanted frequencies while in the program search mode. This is useful to eliminate unwanted permanent transmissions. Up to 30 pass frequencies can be registered for each search bank. A total of 1200 pass frequencies can be registered in the AR6000. It is important to understand the pass function before taking action or transmissions may be missed.

While stopped on unwanted frequency, press the **[PASS]** key.

To enter or add program search pass frequencies, perform the following steps:

1. Press and hold the **[PASS]** key for two seconds.

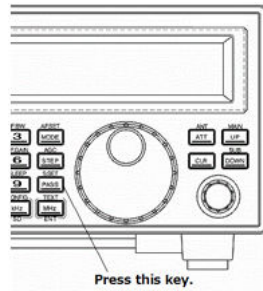

2. The search pass menu appears.



3. Rotate the sub dial to select the search pass bank.
4. Press the **[DOWN]** key.
5. Rotate the sub dial to select the channel.
6. Enter the lower limit frequency from the numeric keypad.
7. Enter the upper limit frequency from the numeric keypad.

If there is an entry error, press the **[PASS]** key.



8. To accept data entry, press the **[MHz]** key.

8-1-2-9 DELETING PASS CHANNELS

To delete one pass channel, perform the following steps:

1. Press and hold the **[PASS]** key for two seconds.
2. Rotate the sub dial to select the bank.
3. Press the **[DOWN]** key.
4. Rotate the sub dial to select the desired channel to delete.
5. Press the **[PASS]** key.

To delete search pass bank (all channels in a search bank), perform the following steps:

1. Press the **[FUNC]** key, and then press and hold the **[.]** key for two seconds.

The following delete menu will appear with “DEL MEM-CH” in reverse contrast.

```

DEL MEM-CH DEL F-PASS BANK
DEL SEL-CH      00
DEL M-PASS     **
DEL SRCH

```

2. Press the **[DOWN]** key to move the cursor downward. Select “DEL F-PASS” in reverse contrast.

```

DEL MEM-CH DEL F-PASS BANK
DEL SEL-CH      01
DEL M-PASS     **
DEL SRCH

```

3. Rotate the sub dial to select the search bank. When the search bank has registered frequencies, “**” will be displayed on the bottom right corner of the LCD. If there is no registered frequency, “- -” will appear. When “v” appears on the bank number, it indicates the VFO search pass frequencies.
4. Press the **[PASS]** key to delete.

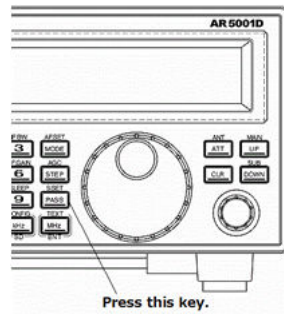

5. Press the **[MHz]** to exit from this menu.

8-1-3 CYBER SEARCH

A special function has been provided to speed up the search process (which is capable of searching about 100 channels per second).

Unlike other normal searching processes, the Cyber search automatically searches all frequencies in the search bank with a signal level above the squelch level and monitors them at the same time.

The search results will be displayed in the signal level order (the strongest signal displays first) not in frequency order.

To activate the Cyber search function, perform the following steps:

1. Press and hold the **[SRCH]** key for two seconds and Cyber search will start.

```

- 57.5dB ATT:0dB AMP ANT:1 ST:010.000k BANK
CYBER CYBER SEARCH | FM 00
430.000000H -- 440.000000H | BH 15.01

```

2. The search indicator will appear on the right of the frequency display.
3. While stopping on the busy frequency, press the **[MHz]** key to transfer the frequency to VFO-C.
4. To stop Cyber search, press the **[VFO]** key.

8-2 SEARCH GROUP

The AR6000 has 20 search groups to be used with the bank link function and other functions.

The following parameters can be registered for each of the search groups.

- Bank link setting
- Search pause
- Search delay
- Voice search
- Auto store

8-2-1 BANK LINK SETTING

To activate the bank link function, perform the following steps:

1. Press the **[FUNC]** key, and then press the **[SRCH]** key. The search link screen will appear.



2. Rotate the sub dial to select the bank link group. Pressing the **[PASS]** key will toggle the link on/off.



3. To select the search bank to be linked, enter the search bank number using the numeric keypad.
If the search bank is between 10 ~ 19, press the **[.]** key to move the cursor to the second row and enter only the first digit of the search bank number from the numeric keypad.
(Example: If the search bank is 12, enter "2".)
4. Press the **[MHZ]** key to complete setting or press the **[DOWN]** key to set other parameters.

8-2-2 SEARCH PAUSE

The search pause parameter determines how long the receiver will remain on an active frequency before resuming searching even if the frequency is still busy. Search pause helps keep you from having to manually intervene to force the search to continue or use frequency lockout (pass).

The parameter ranges are off and 1 to 60 seconds. When the parameter is set to off, the receiver remains on the busy frequency until the received signal disappears or the search frequency is changed.

To set the search pause parameter, perform the following steps:

1. Press the **[FUNC]** key, and then press the **[SCAN]** key. The search link screen will appear.

```

→ -- -- -- -- -- -- -- -- SRCH GRP: 0
-- -- -- -- -- -- -- --
-- -- -- -- -- -- -- -- LINK: OFF
-- -- -- -- -- -- -- --

```

2. Select the bank link group number, and then press the **[DOWN]** key.

The pause setting screen will appear.

```

SRCH BK: 1
PAUSE: 2 VOICE: OFF
DELAY: 2.0 AUTO STORE: OFF

```

3. Rotate the sub dial to set search pause parameter (between 1 ~ 60 or off). To set search pause to off (zero), press the **[PASS]** key or enter “0” from the numeric keypad.
4. To confirm entry, press the **[MHz]** key. To set other parameters, press the **[DOWN]** key.

8-2-3 SEARCH DELAY

The search delay parameter affects the time the AR6000 will remain on an active frequency in search mode once the received signal has disappeared and the squelch is closed. This is particularly useful for customizing how long the receiver will wait for a reply before continuing to search.

The parameter ranges are off, hold and 0.1 to 9.9 seconds.

To set the search delay parameter, perform the following steps:

1. Press the **[FUNC]** key, and then press the **[SRCH]** key. The search link screen will appear.

```

→ -- -- -- -- -- -- -- -- SRCH GRP: 0
-- -- -- -- -- -- -- --
-- -- -- -- -- -- -- -- LINK: OFF
-- -- -- -- -- -- -- --

```

2. Select the bank link group number, and then press the **[DOWN]** key twice.

The pause delay screen will appear.

```

SRCH BK: 1
PAUSE: OFF VOICE: OFF
DELAY: 2.0 AUTO STORE: OFF

```

3. Rotate the sub dial to select the search delay. If “hold” is selected, the receiver will stop searching when the signal is received until either the **[UP]** key, **[DOWN]** key is pressed.
4. To confirm entry, press the **[MHz]** key. To set other parameters, press the **[DOWN]** key.

8-2-4 VOICE SEARCH

When the voice search function is activated, the search process will stop only on active frequencies which have modulation (such as voice) present. The AR6000 will not remain on unmodulated frequencies (such as blank carriers).

The parameter ranges are off, and 1 ~ 7.

To set the voice search parameter, perform the following steps:

1. Press the [FUNC] key, and then press the [SRCH] key. The search link screen will appear.

```
→ -- -- -- -- -- -- -- -- -- SRCH BK: 1
-- -- -- -- -- -- -- -- --
-- -- -- -- -- -- -- -- -- LINK:OFF
-- -- -- -- -- -- -- -- --
```

2. Select the bank link group number, and then press the [DOWN] key three times.

The voice search screen will appear.

```
SRCH BK: 1
PAUSE:OFF VOICE: 3
DELAY:2.0 AUTO STORE:OFF
```

3. Rotate the sub dial to set voice search parameter (between 1 ~ 7 or off). To set voice search to off, press the [PASS] key or enter "0" from the numeric keypad.
4. To confirm entry, press the [MHz] key. To set other parameters, press the [DOWN] key.

8-2-5 AUTO STORE

The auto store function automatically stores the received frequencies into memory. The received frequencies will be saved on memory bank 39. If there is no space to save frequencies on the bank, the auto store function will not work. If the received frequencies are already on the bank, it will not be changed.

To set the auto store function, perform the following steps:

1. Press the [FUNC] key, and then press the [SRCH] key. The search link screen will appear.

```
→ -- -- -- -- -- -- -- -- -- SRCH BK: 1
-- -- -- -- -- -- -- -- --
-- -- -- -- -- -- -- -- -- LINK:OFF
-- -- -- -- -- -- -- -- --
```

2. Select the bank link group number, and then press the [DOWN] key four times.

The auto store screen will appear.

```
SRCH BK: 1
PAUSE:OFF VOICE:OFF
DELAY:2.0 AUTO STORE:ON
```

3. Rotate the sub dial to set on/off.
To delete all auto stored frequencies on the memory bank, press the [PASS] key.
4. To confirm entry, press the [MHz] key. To set other parameters, press the [DOWN] key.

9 CONFIGURATION MENU

The configuration menu is used to set fundamental operating parameters and other variables which do not appear in any menu heading.

```
CONFIGURATION 1/3
LOCAL : JAPAN
BEEP : 1 SQL SKIP:OFF
BPS : 115200 UNIT : dBm
```

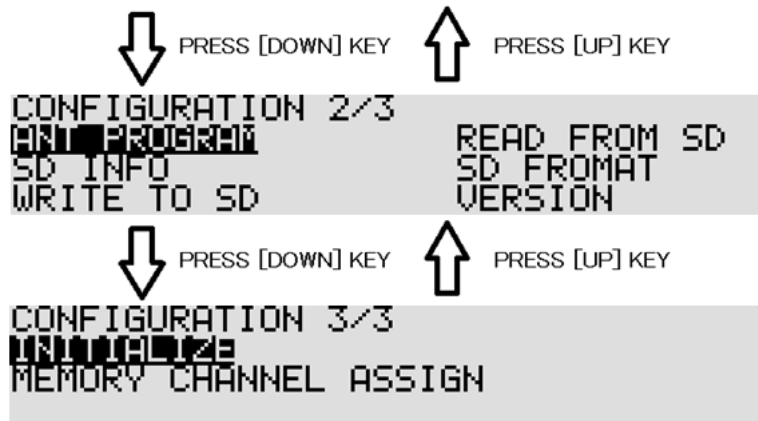

CONFIGURATION MENU 1/3

LAMP	LCD& keypad illumination
BEEP	Confirmation & error tone
BPS	Data communication speed
LOCAL	User's location setting
SQL SKIP	Record audio continuously/ stop while squelch closes
UNIT	Antenna input level unit

CONFIGURATION MENU 2/3

ANT PROGRAM	Antenna input programming
SD INFO	SD card information
WRITE TO SD	Write data to SD card
READ FROM SD	Read data from SD card
SD FORMAT	Format SD card
VERSION	Display the firmware of the receiver

CONFIGURATION MENU 3/3

INITIALIZE	Return the receiver to the factory's default settings
MEMORY CHANNEL ASSIGN	Assign a number of memory channels

9-1 CONFIGURE LAMP

The AR6000 is equipped with high intensity green LEDs to illuminate the LCD when operating in areas of low level lighting.

The lamp may be configured in two ways:

- ON** This is **default** setting. The lamp will continuously illuminate the LCD.
- OFF** The lamp remains permanently extinguished. This is useful when used in areas of high light levels.

To access the configuration menu, press the **[FUNC]** key, and then press the **[kHz]** key.

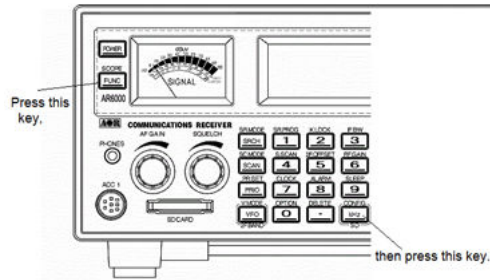

When the “LAMP” is displayed in reverse contrast, rotate the sub dial to toggle the lamp on or off.

Press the **[MHz]** key to accept the entry and return to a standard display.

Alternatively, press the **[CLR]** key to abort entry.

Or, press the **[DOWN]** key to move to the next item on the configuration menu.

9-2 CONFIGURE BEEP

The AR6000 emits confirmation ‘beeps’ while the keypad is used. A ‘HIGH’ pitched beep indicates correct operation while a ‘LOW’ pitched beep indicates that an error or unexpected entry has taken place. The volume of the beep is independent of the main volume control and can be separately defined. It is recommended that the beep function be enabled, especially while learning operation of the receiver.

To access the configuration menu, press the **[FUNC]** key, and then press the **[kHz]** key.

Press the **[DOWN]** key to select “BEEP” in reverse contrast. Rotate the sub dial to select the desired beep level between the range of 0 (off) to 7 (loudest).

Press the **[MHz]** key to accept the entry and return to a standard display.

Alternatively, press the **[CLR]** key to abort entry.

Or, press the **[DOWN]** key to move to the next item on the configuration menu.

9-3 CONFIGURE BPS (BAUD RATE)

The Remote BPS Set menu is used to configure the communication port control settings as it is important that they exactly match those of an associated computer connection.

To access the configuration menu, press the **[FUNC]** key, and then press the **[kHz]** key.

Press the **[DOWN]** key twice to select “BPS” in reverse contrast. Rotate the sub dial to select the desired baud rate from 9600, 19200, 38400, 57600, 115200 bps.

Press the **[MHz]** key to accept the entry and return to a standard display.

Alternatively, press the **[CLR]** key to abort entry.

Or, press the **[DOWN]** key to move to the next item on the configuration menu.

9-4 CONFIGURE LOCAL (LOCATION SETTING)

The AR6000 is capable of selecting the user's location settings. This function is especially useful when you travel abroad with your receiver. The AR6000 has preprogrammed data for three different locations (Europe, Japan, and U.S.A.) which contain the respective band plans and receive modes, etc.

To access the configuration menu, press the **[FUNC]** key, and then press the **[kHz]** key.

Press the **[DOWN]** key three times to select "LOCAL" in reverse contrast. Rotate the sub dial to select the current location from Europe, Japan, and U.S.A.

Press the **[MHz]** key to accept the entry and return to a standard display.

Alternatively, press the **[CLR]** key to abort entry.

Or, press the **[DOWN]** key to move to the next item on the configuration menu.

9-5 CONFIGURE SQL SKIP

The squelch skip menu is used to configure the SD card voice recording when squelch is open or closed.

When squelch skip is set to off, the recording process will take place even when the squelch is closed and no audio signal is present.

When squelch skip is set to on, the recording process will take place only when the squelch is opened and an audio signal is present.

To access the configuration menu, press the **[FUNC]** key, and then press the **[kHz]** key.

Press the **[DOWN]** key four times to select "SQL SKIP" in reverse contrast.

Rotate the sub dial to select either on or off.

Press the **[MHz]** key to accept the entry and return to a standard display.

Alternatively, press the **[CLR]** key to abort entry.

Or, press the **[DOWN]** key to move to the next item on the configuration menu.

9-6 CONFIGURE UNIT

The AR6000 is capable of displaying antenna input level in dBm or dBu.

To access the configuration menu, press the [FUNC] key, and then press the [kHz] key.

Press the [DOWN] key five times to select "UNIT" in reverse contrast.

Rotate the sub dial to select either dBm or dBu.

Press the [MHz] key to accept the entry and return to a standard display.

Alternatively, press the [CLR] key to abort entry.

Or, press the [DOWN] key to move to the next item on the configuration menu.

9-7 CONFIGURE ANT PROGRAM

The AR6000 has two antenna input ports and may be assigned according to the receive frequencies.

Note: 1. When the receiving frequency is below 25 MHz, antenna 2 must be used.

2. When the optional (external) antenna relay switch is connected,
up to 4 antennas may be used.

Configuring example: Antenna 1: 25 MHz ~ 100 MHz

Antenna 2: 200 MHz ~ 300 MHz

To configure the antenna program, perform the following steps:

1. Press the [FUNC] key, and then press the [kHz] key.
2. Press the [DOWN] key six times to go to "Configuration 2/3" and select "ANT PROGRAM" in reverse contrast.

```
CONFIGURATION 2/3
ANT PROGRAM      READ FROM SD
SD INFO          SD FROMAT
WRITE TO SD      VERSION
```

3. Press the [MHz] key.

4. Rotate the main dial to select Antenna 1.

```
ANT: 1
No.   HI           LO
0:   [REDACTED]  [REDACTED]
```

5. Rotate the sub dial to select the desired program number 0.

If the programmed channel is empty, "----.-----" is displayed.

To delete the current channel, press the [PASS] key.

6. Press the [1], [0], [0], [MHz] key to enter the upper limit frequency.

```
ANT: 1
No.   HI           LO
0:   100.000000  [REDACTED]
```

7. Press the [2], [5], [MHz] key to enter the lower limit frequency.
8. On the next screen, rotate the main dial to select Antenna 2.



9. Rotate the sub dial to select the desired program number 0.
10. Press the [3], [0], [0], [MHz] key to enter the upper limit frequency.



11. Press the [2], [0], [0], [MHz] key to enter the lower limit frequency.
12. To confirm programming, press the [CLR] key.

To continue programming, repeat above steps from step 3.

9-8 CONFIGURE SD INFO

The AR6000 has a built-in SD memory card interface used for voice recording and/or memory management.

To display information of the inserted SD memory card, perform the following steps:

1. Insert a SD memory card with a printed label upward facing the slot on the front panel until you can hear a click.
2. Wait until “SD” appears on the top of the LCD.

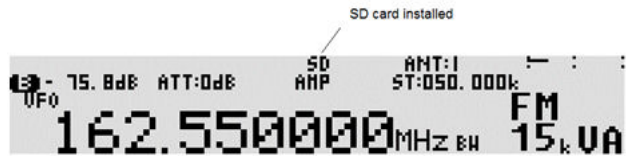

3. Press the [FUNC] key, and then press the [kHz] key.

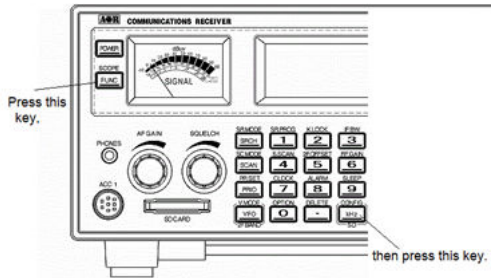

4. When the configuration menu is displayed, press the [DOWN] key seven times to select “SD INFO” in reverse contrast.
5. Press the [MHz] key.

- A sub screen will appear and display information showing total available recording time and the total size of the SD memory card.



- Press the **[MHz]** key to exit from this screen.
- Press the **[CLR]** key to exit the configuration menu.

9-9 CONFIGURE WRITE TO SD

To write memory channel or search bank contents to the SD memory card, perform the following steps:

- Insert a SD memory card with a printed label upward facing the slot on the front panel until you can hear a click.
- Wait until “SD” appears on the top of the LCD.

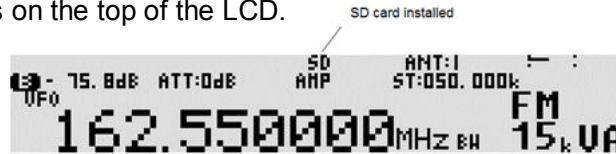

- Press the **[FUNC]** key, and then press the **[kHz]** key.

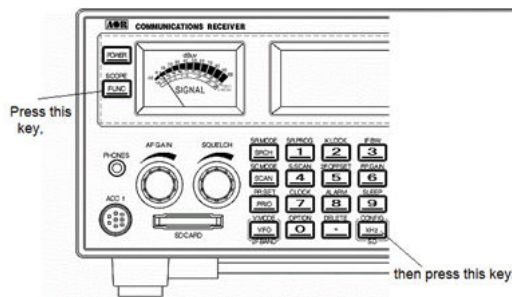

- When the configuration menu is displayed, press the **[DOWN]** key eight times to select “WRITE TO SD” in reverse contrast.

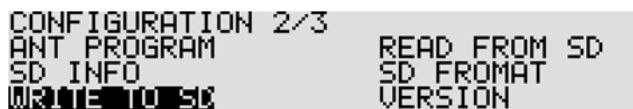

- Press the **[MHz]** key.
- Using the numeric keypad, enter the desired file name. (No file extension required.)



A text of up to eight characters can be assigned to each file name.
Each numeric keypad is assigned to have the following characters:

Key Characters

1	SPACE	
2	1	
3	A	(Example) To select “B”, press the [3] key, then rotate
4	M	the sub dial clockwise.
5	Z	
6	9	
0	-	

To move the cursor, press the [DOWN] key to the left, [UP] key to the right, [PASS] key to erase the character.

7. To confirm entry, press the [MHz] key.



8. When completed, the LCD will display the original screen.

9-10 CONFIGURE READ FROM SD

To read memory channel or search bank contents from the SD memory card, perform the following steps:

1. Insert a SD memory card with a printed label upward facing the slot on the front panel until you can hear a click.
2. Wait until “SD” appears on the top of the LCD.

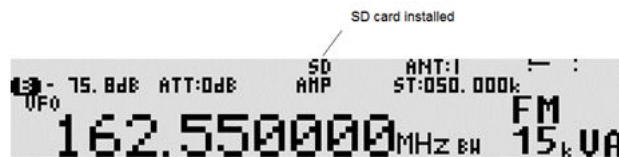

3. Press the [FUNC] key, and then press the [kHz] key.

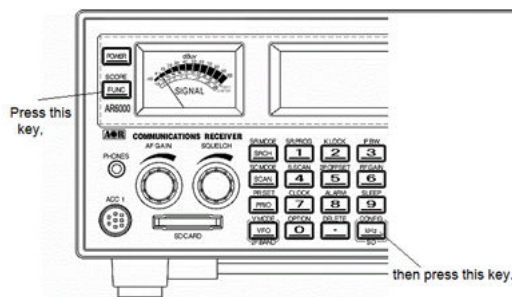

4. When the configuration menu is displayed, press the [UP] key five times to select “READ FROM SD” in reverse contrast.

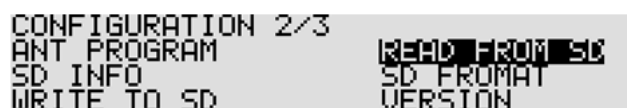

5. Press the **[MHz]** key.
6. A sub screen will appear with a list of memory data file displayed.



7. To change the memory page, rotate the sub dial to select.
8. Using the **[UP]** key or **[DOWN]** key, select the desired file name.
9. Press the **[MHz]** key. Alternatively, press the **[CLR]** key to abort entry.
10. After reading the file data, the receiver will return to a standard display.

9-11 CONFIGURE SD FORMAT

To format an SD card, perform the following steps:

1. Insert a new SD memory card with a printed label upward facing the slot on the front panel until you can hear a click.
2. Wait until “SD” appears on the top of the LCD.

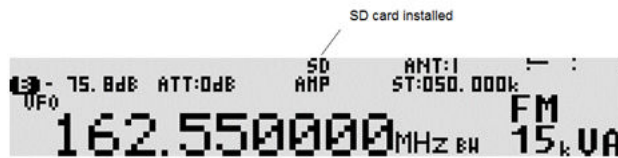

3. Press the **[FUNC]** key, and then press the **[kHz]** key.

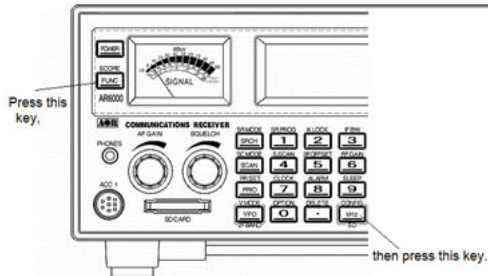

4. When the configuration menu is displayed, press the **[UP]** key four times to select “SD FORMAT” in reverse contrast.
5. Press the **[MHz]** key.
6. If you wish to proceed to format, press the **[MHz]** key.
To cancel formatting, press the **[CLR]** key.



7. Formatting will start.

9-12 CONFIGURE VERSION

To display the current firmware version of the AR6000, perform the following steps:

1. Press the [FUNC] key, and then press the [kHz] key.
2. Press the [UP] key three times to select "VERSION" in reverse contrast.
3. Press the [MHz] key to display the current firmware version of the receiver.



```
CONFIGURATION MESSAGE
ANT PROGR Main_004F D004B MEM SET
SD INFO
EXPORT ME LIZE
```

(Note: Version may vary.)

4. Press any key to return to a standard display.

9-13 CONFIGURE INITIALIZE (RESET)

Initializing the AR6000 will return it to the original factory default settings and all memory contents will be deleted.

To initialize the AR6000, perform the following steps:

1. Press the [FUNC] key, and then press the [kHz] key.

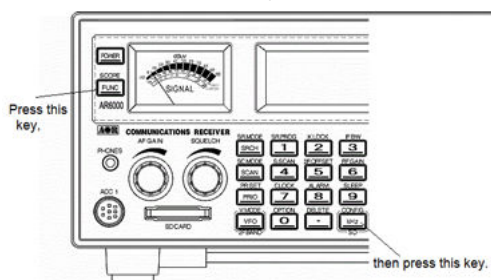

2. Press the [UP] key to select "INITIALIZE" in reverse contrast.



```
CONFIGURATION 3/3
INITIALIZE
```

3. Press the [MHz] key to continue.



```
MESSAGE
ANT P INITIALIZE RECEIVER SET
SD IN OK[MHZ] CANCEL[CLR]
EXPOR
```

4. If you wish to initialize, press the [MHz] key. To cancel, press the [CLR] key.
5. After initialized, the receiver will be powered off automatically, and then restart.

9-14 CONFIGURE MEMORY CHANNEL ASSIGNMENT

A number of memory channels of each memory bank can be freely assigned by user between 5 ~ 95 (not exceeding a total of 2000 channels.)

The default setting is 50 channels x 40 banks.

To change the number of memory channels, perform the following steps:

1. Press the **[FUNC]** key, and then press the **[kHz]** key.
2. Press the **[UP]** key to select "MEMORY CHANNEL ASSIGN" in reverse contrast..
3. Rotate the sub dial to select the desired memory bank.
4. Rotate the main dial to select a new number of the memory channels.
5. To accept entry, press the **[ENT]** key.
6. To cancel, press the **[CLR]** key.

10 OPTION MENU

On the option menu, noise squelch, level squelch hysteresis, notch, noise reduction, noise blanker, voice descrambler, IF shift, AFC, CTCSS, DCS, DTMF, pre-selector, video output, video polarity function may be configured.

10-1 NOISE SQL (NOISE SQUELCH)

This allows control of the signal-to-noise ratio required to unmute the receiver. Only active in AM, FM, WFM, NFM, SFM, FMST receive modes.

To activate the function, perform the following steps:

1. Press the **[FUNC]** key, and then press the **[0]** key.

```

OPTION 1/3 [AM,FM ONLY]
NOISE SQL : OFF NR : OFF
LSQL HYS : 6dB NB : OFF
NOTCH : OFF SCR : OFF
    
```

2. Rotate the sub dial to select the noise squelch level between 1 and 255. (This function can be set to OFF by pressing the **[PASS]** key.)
3. Press the **[MHz]** key to accept the entry and return to a standard display.

10-2 LSQL HYS (LEVEL SQUELCH HYSTERISIS)

This function is to set the depth of hysteresis for level squelch.

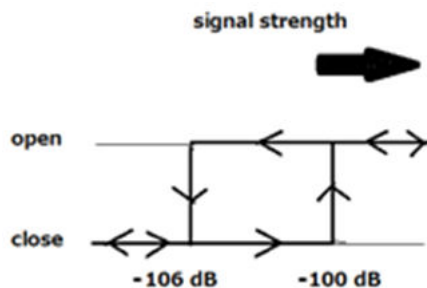

[Example]: Squelch level: -100 dB, Hysteresis: 6 dB

Squelch opens when the input level is above -100 dB.

Squelch will not close until the input level drops below -106 dB.

To activate the function, perform the following steps:

1. Press the **[FUNC]** key, and then press the **[0]** key.

```
OPTION 1/3 [AM,FM ONLY]
NOISE SWL :OFF NR :OFF
LSQL HYS :6dB NB :OFF
NOTCH :OFF SCR :OFF
```

2. Press the **[DOWN]** key to select “LSQL HYS” in reverse contrast.
3. Rotate the sub dial to select the hysteresis level from the range of 0 ~ 9 dB.
4. Press the **[MHz]** key to accept the entry and return to a standard display.

Alternatively, press the **[CLR]** key to abort entry, or press the **[DOWN]** key to move to the next item on the configuration menu.

10-3 NOTCH (AUTO NOTCH)

Auto notch function is effective for cycle noise on the receive signal.

To activate the function, perform the following steps:

1. Press the **[FUNC]** key, and then press the **[0]** key.

```
OPTION 1/3 [AM,FM ONLY]
NOISE SWL :OFF NR :OFF
LSQL HYS :6dB NB :OFF
NOTCH :OFF SCR :OFF
```

2. Press the **[DOWN]** key to select “NOTCH” in reverse contrast.
3. Rotate the sub dial to select the level from the choice of OFF, LOW, MID, and HIGH.
4. Press the **[MHz]** key to accept the entry and return to a standard display.

Alternatively, press the **[CLR]** key to abort entry, or press the **[DOWN]** key to move to the next item on the configuration menu.

10-4 NR (NOISE REDUCTION)

Noise reduction function is effective for random noise on the receive signal.

To activate the function, perform the following steps:

1. Press the **[FUNC]** key, and then press the **[0]** key.

```
OPTION 1/3 [AM,FM ONLY]
NOISE SWL :OFF NR :OFF
LSQL HYS :6dB NB :OFF
NOTCH :OFF SCR :OFF
```

2. Press the **[DOWN]** key three times to select “NR” in reverse contrast.
3. Rotate the sub dial to select the level from the choice of OFF, LOW, MID, and HIGH.
4. Press the **[MHz]** key to accept the entry and return to a standard display.

Alternatively, press the **[CLR]** key to abort entry, or press the **[DOWN]** key to move to the next item on the configuration menu.

10-5 NB (NOISE BLANKER)

Noise blanker function is effective for pulse noise on the receive signal.

To activate the function, perform the following steps:

1. Press the [FUNC] key, and then press the [0] key.

```
OPTION 1/3 [AM,FM ONLY]
NOISE BLANKER : OFF NR : OFF
LSQL HYS : 6dB NB : OFF
NOTCH : OFF SCR : OFF
```

2. Press the [DOWN] key four times to select “NB” in reverse contrast.
3. Rotate the sub dial to select on/off.
4. Press the [MHz] key to accept the entry and return to a standard display.

Alternatively, press the [CLR] key to abort entry, or press the [DOWN] key to move to the next item on the configuration menu.

10-6 SCR (ANALOG VOICE DESCRAMBLER)

(Not available for US consumer version)

Analog voice descrambler is used to decode scrambled analog voice transmission by frequency inversion.

Note: This function operates only in the NFM mode.

To activate the function, perform the following steps:

1. Press the [FUNC] key, and then press the [0] key.

```
OPTION 1/3 [AM,FM ONLY]
NOISE BLANKER : OFF NR : OFF
LSQL HYS : 6dB NB : OFF
NOTCH : OFF SCR : OFF
```

2. Press the [DOWN] key five times to select “SCR” in reverse contrast.
3. Rotate the sub dial to select the inversion frequency from the range of 2000 Hz ~ 7000 Hz in 10 Hz step.
Once properly selected, the decoded voice becomes intelligible.
4. Press the [MHz] key to accept the entry and return to a standard display.

To disable this function, press the [PASS] key.

10-7 IF-SFT (IF SHIFT)

IF shift is effective to reject any adjacent signal frequencies that cause interference to the receive frequency. The IF shift operates to shift the IF filter passband to keep away from the interfering signal without changing the receive frequency.

Note: This function operates only in the AM, SSB, AIQ modes.

To activate the function, perform the following steps:

1. Press the [FUNC] key, and then press the [0] key.
2. Press the [DOWN] key six times to select "IF-SFT" in reverse contrast.

```

OPTION 2/3 [AM, USB, LSB, AIQ]
IF-SFT : OFF  DCS : OFF
AFC : OFF  DTMF : OFF
CTCSS : OFF  PRESEL : ON

```

3. Rotate the sub dial to select the shift frequency from the range of -1200 Hz ~ +1200 Hz, in 50 Hz steps.
4. Press the [MHz] key to accept the entry and return to a standard display.

Alternatively, press the [CLR] key to abort entry, or press the [DOWN] key to move to the next item on the configuration menu.

10-8 AFC (AUTOMATIC FREQUENCY CONTROL)

To activate the function, perform the following steps:

1. Press the [FUNC] key, and then press the [0] key.

```

OPTION 1/3 [AM, FM ONLY]
NOISE SQL : OFF  NR : OFF
LSQL HYS : 6dB  NB : OFF
NOTCH : OFF  SCR : OFF

```

2. Press the [DOWN] key several times to select "AFC" in reverse contrast.

```

OPTION 2/3 [AM, USB, LSB, AIQ]
IF-SFT : OFF  DCS : OFF
AFC : OFF  DTMF : OFF
CTCSS : OFF  PRESEL : ON

```

3. Rotate the sub dial to select on/off.
4. Press the [MHz] key to accept the entry and return to a standard display.

* AFC does only work in NFM mode with a filter setting up to 30kHz.

* It does not automatically retune the receiver to the nearest strong signal.
 Example: If there is a signal at 150MHz, but the user tunes the receiver to 149.5MHz, the AFC function will NOT retune the receiver to 150MHz!

* Real function of AFC: It tunes the IF filter's frequency automatically when an unstable frequency is received. It does not change the receive frequency. Since only IF is changed, there is no "visual" change on the control program's spectrum or frequency display. The change can only be heard on "audio".

* It only works if the sending station's frequency shifts are within the selected IF filter's bandwidth.
 For example: IF=15kHz >> +/-7kHz, IF=30kHz >> +/-15kHz

10-9 CTCSS (CONTINUOUS TONE CONTROLLED SQUELCH SYSTEM)

CTCSS function will enable the AR6000 to selectively receive only specifically modulated sub-audible tones or to verify the CTCSS frequency used.

Note: This function operates only in the NFM mode with a frequency of 25 MHz or higher.

To activate the function, perform the following steps:

1. Press the [FUNC] key, and then press the [0] key.

```

OPTION 1/3 [AM, FM ONLY]
NOISE SQL : OFF  NR : OFF
LSQL HYS : 6dB  NB : OFF
NOTCH : OFF  SCR : OFF

```

2. Press the [DOWN] key several times to select "CTCSS" in reverse contrast.

```

OPTION 2/3 [FREQ >25MHZ]
AFC :OFF DTMF :OFF
CTCSS :71.9 PRESEL :OFF
DCS :OFF VIDEO OUT:OFF

```

3. Rotate the sub dial to toggle between OFF, ALL, or to select the inversion frequency from the range of 60 Hz ~ 254.1 Hz as from the list below. To set CTCSS to ALL, you can also press the **[PASS]** key.

60.0	67.0	69.3	71.9	74.4
77.0	79.7	82.5	85.4	88.5
91.5	94.8	97.4	100.0	103.5
107.2	110.9	114.8	118.8	120.0
123.0	127.3	131.8	136.5	141.3
146.2	151.4	156.7	159.8	162.2
165.5	167.9	171.3	173.8	177.3
179.9	183.5	186.2	189.9	192.8
196.6	199.5	203.5	206.5	210.7
218.1	225.7	229.1	233.6	241.8
250.3	254.1	ALL		

CTCSS frequencies (in Hz)

4. Press the **[MHz]** key to accept the entry and return to a standard display.

Alternatively, press the **[CLR]** key to abort entry, or press the **[DOWN]** key to move to the next item on the configuration menu.

10-10 DCS (DIGITAL CODED SQUELCH)

DCS function is used to decode a selected digital code that uses 23 bit code data sent lower than the voice frequency. The data speed is 134.3 bit/sec in NRZ (Non-Return-Zero) format FM modulation.

Note: This function operates only in the NFM mode with a frequency of 25 MHz or higher.

To activate the function, perform the following steps:

1. Press the **[FUNC]** key, and then press the **[0]** key.

```

OPTION 1/3 [AM,FM ONLY]
NOISE SW :OFF NR :OFF
LSQL HYS :6dB NB :OFF
NOTCH :OFF SCR :OFF

```

2. Press the **[DOWN]** key several times to select "DCS" in reverse contrast.

```

OPTION 2/3 [FREQ >25MHZ]
AFC :OFF DTMF :OFF
CTCSS :OFF PRESEL :OFF
DCS :023 VIDEO OUT:OFF

```

3. Rotate the sub dial to toggle between OFF, ALL or to select the DCS code from the list below.

To set DCS to ALL, you can alternatively press the **[PASS]** key.

017	023	025	026	031	032	036	043	047	050
051	053	054	065	071	072	073	074	114	115
116	122	125	131	132	134	143	145	152	155
156	162	165	172	174	205	212	223	225	226
243	244	245	246	251	252	255	261	263	265
266	271	274	306	311	315	325	331	332	343
346	351	356	364	365	371	411	412	413	423
431	432	445	446	452	454	455	462	464	465
466	503	506	516	523	526	532	546	565	606
612	624	627	631	632	654	662	664	703	712
723	731	732	734	743	754	ALL			

DCS codes

4. Press the **[MHz]** key to accept the entry and return to a standard display.

Alternatively, press the **[CLR]** key to abort entry, or press the **[DOWN]** key to move to the next item on the configuration menu.

10-11 DTMF (DUAL TONE MULTI FREQUENCY)

DTMF tones are used by many VHF/UHF communications services and amateur radio operators to control switching devices and to enable selective calling. The AR6000 has the capability to decode all 16 DTMF tones.

The decoded DTMF characters will automatically be displayed on the LCD when the function has been activated.

Frequency	1209 (Hz)	1336 (Hz)	1447 (Hz)	1633 (Hz)
697 (Hz)	1	2	3	A
770 (Hz)	4	5	6	B
852 (Hz)	7	8	9	C
941 (Hz)	*	0	#	D

DTMF tones

To activate the function, perform the following steps:

1. Press the **[FUNC]** key, and then press the **[0]** key.

```

OPTION 1/3 [AM,FM ONLY]
NOISE SWL :OFF NR :OFF
LSQL HYS :6dB NB :OFF
NOTCH :OFF SCR :OFF

```

2. Press the **[DOWN]** key several times to select "DTMF" in reverse contrast.

3. Rotate the sub dial to select on/off.

4. Press the **[MHz]** key to accept the entry and return to a standard display.

Alternatively, press the **[CLR]** key to abort entry, or press the **[DOWN]** key to move to the next item on the configuration menu.

10-12 PRESEL (PRE-SELECTION FILTER)

The AR6000 has a built-in selectable pre-selection (bandpass) filter which will work for any frequency below 25 MHz.

To select the pre-selection filter, perform the following steps:

1. Press the [FUNC] key, and then press the [0] key.

```
OPTION 1/3
SQL HWs 92dB NB : OFF
NOTCH : OFF SCR : OFF
NR : OFF IF-SFT : OFF
```

2. Press the [DOWN] key several times to select "PRESEL" in reverse contrast.
3. Rotate the sub dial to select on/off.

4. Below is a list of pre-selection filters.

Band	Passband
1	9 kHz ~ 500 kHz
2	500 kHz ~ 1.6 MHz
3	1.6 MHz ~ 3 MHz
4	3 MHz ~ 5 MHz
5	5 MHz ~ 10 MHz
6	10 MHz ~ 15 MHz
7	15 MHz ~ 20 MHz
8	20 MHz ~ 25 MHz

5. Press the [MHz] key to accept the entry and return to a standard display.

Alternatively, press the [CLR] key to abort entry, or press the [DOWN] key to move to the next item on the configuration menu.

Note: On the spectrum scope screen, signals of only the selected frequency range can be displayed while the filter is on.

10-13 VIDEO OUT (VIDEO OUTPUT)

Note: This function operates with a frequency of 25 MHz or higher.

The AR6000 has a built-in (analog) video decoder and composite video signal output is available from the video output connector on the rear panel.

Note: Digital broadcast TV cannot be decoded with the AR6000.

To activate the video output function, perform the following steps:

1. Press the [FUNC] key, and then press the [0] key.

```

OPTION 1/3 [AM,FM ONLY]
NOISE SWL :OFF NR :OFF
LSQL HYS :6dB NB :OFF
NOTCH :OFF SCR :OFF

```

2. Press the [DOWN] key several times to select "VIDEO OUTPUT" in reverse contrast.
3. Rotate the sub dial to select on/off.
4. Press the [MHz] key to accept the entry and return to a standard display.

Alternatively, press the [CLR] key to abort entry, or press the [DOWN] key to move to the next item on the configuration menu.

10-14 VIDEO IMG (VIDEO MODULATION POLARITY)

Note: This function operates with a frequency of 25 MHz or higher.

In some cases, certain FM video signals may be transmitted with an IF frequency reversed, and consequently, the received video signal cannot be properly decoded.

The AR6000 has a shift direction reverse function to correct the problem.

To activate the video modulation polarity function, perform the following steps:

1. Press the [FUNC] key, and then press the [0] key.

```

OPTION 1/3
LSQL HYS :6dB NB :OFF
NOTCH :OFF SCR :OFF
NR :OFF IF-SFT :OFF

```

2. Press the [DOWN] key several times to select "VIDEO IMG" in reverse contrast.
3. Rotate the sub dial to select normal or reverse.
4. Press the [MHz] key to accept the entry and return to a standard display.

Alternatively, press the [CLR] key to abort entry, or press the [DOWN] key to move to the next item on the configuration menu.

11 MISCELLANEOUS FUNCTIONS

11-1 STEP ADJUST

Step adjust function is used when the receiving frequency is not divisible by the current step size to follow unusual band plans. (It is automatically adjusted in the auto mode.)

(Example):

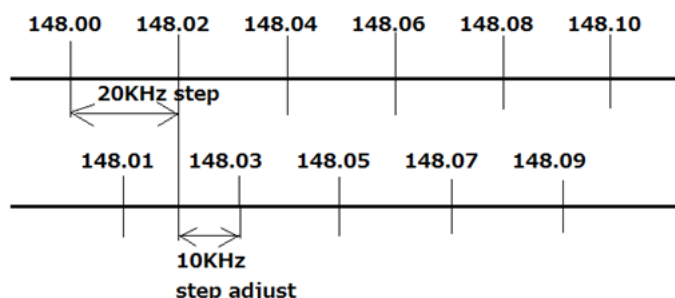

To activate the step adjust function, perform the following steps:

1. Press the [STEP] key.

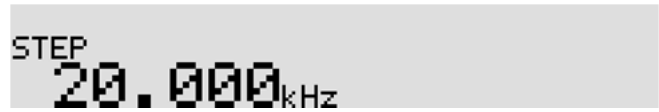

2. Press the [PASS] key. "*" (asterisk) appears right next to "STEP".



3. Enter the new step frequency using a numeric keypad or rotating the sub dial.
4. Press the [MHz] key to accept the entry and return to a standard display.
Alternatively, press the [CLR] key to abort entry.
5. "STEP-ADJ" will appear right above the frequency.



6. To cancel step adjust, repeat above steps.

11-2 SUB DIAL SETTING

The sub dial can be used to select the receive frequency in three different ways.

- Same step size as the main dial
- 10 times faster than the main dial
- One of the step sizes from 0.1 kHz (100 Hz), 0.5 kHz (500 Hz), 1 kHz, 5 kHz, 10 kHz, 50 kHz, 100 kHz, 500 kHz, 1000 kHz (1 MHz)

To select the sub dial step frequency, perform the following steps:

1. Press the [STEP] key.
2. Press the [UP] key.
3. Rotate the sub dial to select the new step frequency.
4. Press the [MHz] key to accept the entry and return to a standard display.
Alternatively, press the [CLR] key to abort entry.

Sub dial step frequency list

MAIN, X10, 0.1 kHz, 0.5 kHz, 1 kHz, 5 kHz, 10 kHz, 50 kHz, 100 kHz, 500 kHz, 1000 kHz



(***Note: MAIN: Same step frequency with the main dial
X10: 10 times faster than the main dial***)

11-3 VFO SETTING

11-3-1 TRANSFER FREQUENCY TO VFO

11-3-1-1 WHILE IN SEARCH MODE

- While stopping on the busy frequency

Press the [**SRCH**] key or [**MHz**] key. The active frequency will be transferred to VFO-D, and the AR6000 will switch to VFO-D automatically.

- While searching

Press the [**SRCH**] key. The active frequency will be transferred to VFO-D, and the AR6000 will switch to VFO-D automatically.

```
SRCH -117.9dB ATT:0dB SD AMP ANT:1 BANK
144.940000MHz FM 00
15k SR
```

11-3-1-2 WHILE IN SCAN MODE

- While stopping on the busy channel or in memory read mode

Press the [**MHz**] key. The active channel will be transferred to VFO-C, and the AR6000 will switch to VFO-C automatically.

- While scanning

Press the [**SCAN**] key, and then press the [**MHz**] key. The active channel will be transferred to VFO-C, and the AR6000 will switch to VFO-C automatically.

```
SCAN -117.4dB ATT:0dB SD AMP ANT:1 BANK
144.170000MHz FM 38
15k 01
```

11-3-1-3 BETWEEN VFOs

This function enables you to copy the current VFO frequency to another VFO.

To activate the VFO copy function, perform the following steps:

1. In VFO mode, press and hold the [**MHz**] key for two seconds.

```
144.940000MHz
MEM SET VFO COPY(Press[.])
BANK:00
CH :00
```

2. Press the [**.**] key.

```
VFO COPY VFO-D -> [2]:B
144.940000MHz [3]:C
[4]:D
```

3. Rotate the sub dial to select the desired VFO to be copied.
4. Press the [**MHz**] key to accept the entry and return to a standard display.
Alternatively, press the [**CLR**] key to abort entry.

11-3-2 VFO SEARCH DELAY

The VFO search delay parameter affects the time the AR6000 will remain on an active frequency in VFO search mode once the received signal has disappeared and the squelch closed. This is particularly useful for customizing how long the receiver will wait for a reply before continuing to search.

The parameter ranges are off, hold and 0.1 to 9.9 seconds in 0.1 second step.

To set the VFO search delay parameter, perform the following steps:

1. Press the **[FUNC]** key, and then press the **[VFO]** key.



VFO MODE
DEL:VFO.2
VOICE: 4

2. Rotate the sub dial to select the delay time. To set it “OFF”, press the **[PASS]** key.
3. To confirm entry, press the **[MHz]** key. To set other parameters, press the **[DOWN]** key.

11-3-3 VFO VOICE SQUELCH

When the VFO voice squelch function is activated, the audio will be muted on unmodulated voice signals.

The squelch parameter ranges are off and 1 ~ 7.

To set the voice squelch parameter, perform the following steps:

1. Press the **[FUNC]** key, and then press the **[VFO]** key.



VFO MODE
DEL:VFO.2
VOICE: 4

2. Press the **[DOWN]** key to select “VOICE” in reverse contrast.
3. Rotate the sub dial to set voice squelch parameter (between 1 ~ 7 or off).

To set it to off, press the **[PASS]** key.

4. To confirm entry, press the **[MHz]** key. To set other parameters, press the **[DOWN]** key.
5. While the VFO squelch function is activated, “VCS” will appear on the LCD.



VOICE SQUELCH FUNCTION ACTIVATED.

- 95.1dB ATT:0dB ANT:1
VFO VCS 81.300000MHz Bk 200k VA FM

11-4 AUDIO FILTERS

11-4-1 LPF (LOW PASS FILTER)

The audio low pass filter cuts off high tones to improve intelligibility of weak signals close to adjacent interference and removes hiss. This makes listening for extended periods of time easier on the ears.

There are three available selections for cut off frequencies: 3 kHz, 6 kHz, and THROUGH.

The low pass filter is automatically selected according to the IF bandwidth.

Conditions	Cut off frequency
IF bandwidth: Less than 6 kHz	3 kHz
IF bandwidth: 15 kHz	6 kHz
IF bandwidth: More than 30 kHz	THRU

Note: Low pass filter is not selectable in CW mode.

To select low pass filter cut off frequency, perform the following steps:

1. Press the **[FUNC]** key, and then press the **[MODE]** key.

```
AF SETTING
A-LPF :THRU CW.PITCH :800Hz
A-HPF :THRU
WFM DE.EMP:50uSEC
```

2. Rotate the sub dial to select the desired cut off frequency.
3. Press the **[MHz]** key to accept the entry and return to a standard display.
Alternatively, press the **[CLR]** key to abort entry.

11-4-2 HF (HIGH PASS FILTER)

The audio high pass filter limits the audio base response improving intelligibility in certain circumstances.

There are three available selections for cut off frequencies: 0.3 kHz, 0.6 kHz, and THRU.

The high pass filter is automatically selected according to the IF bandwidth.

Conditions	Cut off frequency
IF bandwidth: 0.5 kHz ~ 15 kHz	0.3 kHz
IF bandwidth: More than 30 kHz	THRU
AM, LSB, USB modes	THRU

To select high pass filter cut off frequency, perform the following steps:

1. Press the **[FUNC]** key, and then press the **[MODE]** key.

```
AF SETTING
A-LPF :THRU CW.PITCH :800Hz
A-HPF :THRU
WFM DE.EMP:50uSEC
```

2. Press the **[DOWN]** key to select "A-HPF" in reverse format.

```
AF SETTING
A-LPF :THRU CW.PITCH :800Hz
A-HPF :THRU
WFM DE.EMP:50uSEC
```

3. Rotate the sub dial to select the desired cut off frequency.
4. Press the **[MHz]** key to accept the entry and return to a standard display.

Alternatively, press the **[CLR]** key to abort entry.

11-4-3 DE-EMPHASIS

The audio de-emphasis is only applicable to WFM mode and affects the sharpness of recovered audio.

The value of de-emphasis varies from country to country.

There are two available selections for audio de-emphasis of value: 50 μ S, and 75 μ S.

To select audio de-emphasis value, perform the following steps:

1. Press the [FUNC] key, and then press the [MODE] key.

```
AF SETTING
A-LPF : THRU CW.PITCH : 800Hz
A-HPF : THRU
WFM DE.EMP: 50uSEC
```

2. Press the [DOWN] key twice to select "W. FM DE. EMP" in reverse format.

```
AF SETTING
A-LPF : THRU CW.PITCH : 800Hz
A-HPF : THRU
WFM DE.EMP: 50uSEC
```

3. Rotate the sub dial to select the desired de-emphasis value.
4. Press the [MHz] key to accept the entry and return to a standard display.

Alternatively, press the [CLR] key to abort entry.

11-4-4 CW PITCH

Comfortable listening to CW is usually centered around a tone of 700 Hz to 800 Hz. However, the center frequency may be changed according to personal preferences. The selectable range is between 300 Hz ~ 1100 Hz in 50 Hz step. Note this function is available only in CW mode.

To select the CW pitch frequency, perform the following steps:

1. Press the [FUNC] key, and then press the [MODE] key.

```
AF SETTING
A-LPF : THRU CW.PITCH : 800Hz
A-HPF : THRU
WFM DE.EMP: 50uSEC
```

2. Press the [DOWN] key three times to select "CW.PITCH" in reverse format.

```
AF SETTING
A-LPF : THRU CW.PITCH : 800Hz
A-HPF : THRU
WFM DE.EMP: 50uSEC
```

3. Rotate the sub dial to select the desired CW pitch frequency.
4. Press the [MHz] key to accept the entry and return to a standard display.

Alternatively, press the [CLR] key to abort entry.

11-5 CLOCK

The AR6000 is equipped with two independent real time clocks capable of either 12 H/ 24 H format displaying hours, minutes, and seconds. Each clock can also display a three character text comment for identification.

When the AR6000 is switched off, but power is still connected, the clock is displayed on the LCD without back illumination.

11-5-1 INITIAL SET

To access the clock set menu, perform the following steps:

11-5-1-1 CLOCK 1

1. Press the **[FUNC]** key, and then press and hold the **[7]** key for two seconds.



2. Rotate the sub dial to select either 12H or 24H. This selection affects both clocks.
3. Press the **[DOWN]** key to select "CLOCK" in reverse format.
4. Using the main dial, adjust hours.
5. Using the sub dial, adjust minutes.
6. Press the **[DOWN]** key to select "TEXT" in reverse format.
7. Add the text comment (three characters) using the numeric keypad and sub dial.

(Example): "PST"

Key Characters

1	[SPACE]
2	1
3	A
4	M
5	Z
6	9
0	-

(Example) To select "P", press the **[4]** key, then rotate the sub dial 3 times clockwise.

- a) Press the **[4]** key. Rotate the sub dial to select "P".
- b) Press the **[UP]** key to move the cursor to the right.
- c) Press the **[4]** key. Rotate the sub dial to select "S".
- d) Press the **[UP]** key.

e) Press the [4] key. Rotate the sub dial to select “T”.

If needed, the [.] key adds as blank space and the [PASS] key erases the selected character.

8. Press the [MHz] key to adjust clock 2.

11-5-1-2 CLOCK 2

1. Using the main dial, adjust hours. The minutes and seconds are taken from clock 1.

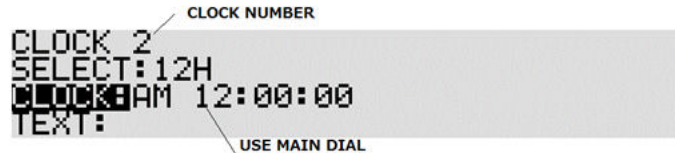

2. Press the [DOWN] key.

3. Add the text comment (three characters) using the numeric keypad and sub dial.

(Example): “UTC”

Key Characters

1 [SPACE]

2 1

3 A (Example) To select “U”, press the [4] key, then rotate the sub dial 8 times clockwise.

4 M

5 Z

6 9

0 -

a) Press the [4] key. Rotate the sub dial to select “U”.

b) Press the [UP] key to move the cursor to the right.

c) Press the [4] key. Rotate the sub dial to select “T”.

d) Press the [UP] key.

e) Press the [3] key. Rotate the sub dial to select “C”.

If needed, the [.] key adds as blank space and the [PASS] key erases the selected character.

4. Press the [MHz] key to adjust calendar.

11-5-1-3 CALENDAR

1. Rotate the sub dial to adjust year.

CALENDAR
YEAR: 2010
MONTH: 4
DAY: 5

2. Press the [DOWN] key.

3. Rotate the sub dial to adjust month.

4. Press the [DOWN] key.

5. Rotate the sub dial to adjust day.
6. Press the [MHz] key to confirm entry.

11-5-2 DISPLAYING THE CLOCK

Press the [FUNC] key, and then press the [7] key.
 Rotate the sub dial to toggle between clock 1 and clock 2.

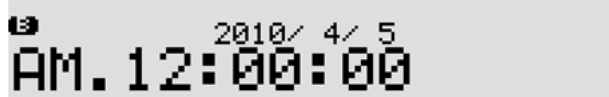

To return to a standard display, press the [FUNC] key, and then press the [7] key.

11-5-3 ALARM PROGRAMMING

To access the alarm menu, perform the following steps:

1. Press the [FUNC] key, and then press and hold the [8] key for two seconds.
2. Rotate the main dial to set the hour, and the sub dial to select the minutes for automatic switch on.

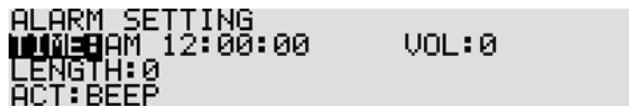

3. Press the [DOWN] key to select "LENGTH" in reverse contrast.
4. Rotate the sub dial to select how long (in minutes) the ALARM or RADIO will stay powered-on once the alarm has activated. The available time period is from 1 to 120 minutes.

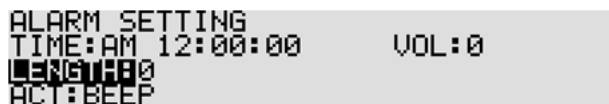

5. Press the [DOWN] key to select "ACT" in reverse contrast.

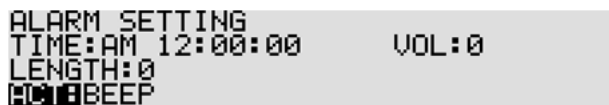

6. Rotate the sub dial to select from "BEEP", "RADIO", "RADIO (SD REC, SQL SKIP ON)", and "RADIO (SD REC, SQL SKIP OFF)".

- BEEP
 Beep sounds for the period set below when clock 1 reaches the time set here.
- RADIO
 Radio will be switched on at the time set here and remain on for the period set below.
- RADIO (SD REC, SQL SKIP ON)
 Radio will be switched on at the time set here and audio signal is recorded on SD card while squelch opens.

- RADIO (SD REC, SQL SKIP OFF)

Radio will be switched on at the time set here and audio signal is recorded on SD card even when squelch is closed.

7. Press the [DOWN] key to select “VOL” in reverse contrast.

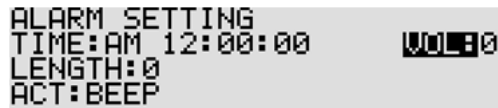

```

ALARM SETTING
TIME: AM 12:00:00    VOL: 0
LENGTH: 0
ACT: BEEP
  
```

8. Rotate the sub dial to select the volume level from the range of 0 ~ 7 for beep and 0 ~ 255 for radio during alarm activation.

9. Press the [MHz] key to accept the entry and return to a standard display.

Alternatively, press the [CLR] key to abort entry.

11-5-4 ALARM ACTIVATION

Once the alarm has been activated, “ALARM” will be displayed on the top middle of the LCD. The AR6000 will switch on automatically once per day (presuming the receiver had been switched off) on a daily basis at the defined volume level and for the programmed length time before automatically switching off again until the same time on the following day.

To activate the alarm function, perform the following steps:

1. Press the [FUNC] key, and then press the [8] key. “ALARM” will be displayed on the top middle of the LCD.



```

ALARM
ATT: 0dB
SD ANP AUTO ST: 025.000k
ANT: 2
81.300000 MHz FM 200k VA
  
```

2. Switch the AR6000 off by pressing the [POWER] switch on the front panel.

Note: Do not turn the main power switch off or unplug the power cable from the receiver.

3. When the preset time has arrived, either the beep will sound or the radio will automatically switch on (the receive frequency will be the last one used.)

Press any key to stop alarm when automatic switch on has occurred.

The receiver will remain active for the duration set above.

11-5-5 SLEEP TIMER

Once the sleep timer is activated, the AR6000 will automatically switch off after the sleep time duration has expired.

To set sleep timer, perform the following steps:

1. Press the [FUNC] key, and then press and hold the [9] key for two seconds.

2. On the sleep timer screen, rotate the sub dial to select sleep time from the period from 1 ~ 120 (minutes) in one minute increments.



3. Press the [MHz] key to accept the entry and return to a standard display.
Alternatively, press the [CLR] key to abort entry.

To activate the sleep timer, press the [FUNC] key, and then press the [9] key.
“SLEEP” will be displayed on the top middle of the LCD.



To de-activate the alarm function, press the [FUNC] key and then press the [9] key.

Note: Do not press the [POWER] key while the sleep timer is activated.

11-6 PRIORITY FUNCTION

The priority function enables you to carry on scanning, searching or monitoring while the AR6000 checks a selected frequency for activity (taken from one of the 2,000 memory channels periodically).

The priority checking is accomplished by momentarily tuning the receive circuit to the priority frequency to see if it is **active**. If the activity is found, the AR6000 will remain on the active frequency until the signal disappears. If no activity is detected, the receiver returns to the VFO frequency, scan channel or search bank from where it originated.

The priority function has a large number of applications and is particularly useful for keeping an eye on a distress frequency while scanning or searching another frequency band.

Note: Depending upon the frequency and mode stored as priority, an audible **click** may be heard when the priority function is in operation. This is quite normal and is caused by the internal switching of circuitry necessary to accomplish the frequency change.

11-6-1 CONFIGURING PRIORITY CHANNEL

Once activated, the frequency is periodically checked for activity based on the preset period set by the configuration menu.

To configure the priority function, perform the following steps:

(Example): Select memory bank 1, memory channel 30, priority sampling interval 10 seconds

1. Press the [FUNC] key, and then press the [PRIO] key.

The priority channel configuration menu appears.

```
PRIO: 81.300000MHz
SEIBANK 01 CH 30
      80.000000MHz
P-INTER:10
```

2. Rotate the sub dial to select the memory bank. (Select 1 on this example.)
3. Rotate the main dial to select the memory channel. (Select 30 on this example.)
4. Press the [DOWN] key to select “P-INTER” in reverse contrast.
5. Rotate the sub dial to select the desired time from the range of 1 ~ 60 seconds. (Select 10 on this example.)
6. Press the [MHz] key to accept the entry and return to a standard display.
Alternatively, press the [CLR] key to abort entry.

11-6-2 ACTIVATING PRIORITY FUNCTION

To activate the priority function, press the [PRIO] key. “PRIO” will be displayed on the top of the LCD.

```
SD PRIO ANT:2 : : :
ARP AUTO ST:025.000k
-106.3dB ATT:0dB
UF0 80.000000MHz FM
200k VA
```

To de-activate the function, press the [PRIO] key again.

11-7 RF GAIN CONTROL

It is possible to configure the squelch control to function as RF gain control by pressing the [FUNC] key, and then pressing the [6] key.

The RF gain control reduces the level of amplification applied to the receiver’s circuits. This has the effect of reducing the sensitivity of the receiver.

The normal position for the AR6000 RF gain control is fully counterclockwise when set at its most sensitive. As the control is rotated clockwise, the S-meter will advance to indicate what strength signal is required to produce solid and readable results.

The control is most useful on SSB most where RF gain should be adjusted so that the peaks of SSB signals just deflect the S-meter. This will greatly reduce the level of background noise especially during pauses in speech or inactivity.

Note: RF gain control is not available in FM mode.

Before using the RF gain control, the AGC must be set to off.

To activate RF gain control, press the [FUNC] key, and then press the [6] key.

To change RF gain, rotate the squelch knob.

To de-activate RF gain, repeat above steps.

12 PC CONTROL

12-1 USB INTERFACE

The USB (type B) connector is designed to connect directly to the USB port of a PC.
All functions of the AR6000 can be controlled by a PC by means of the USB interface.
A free control and memory management software can be downloaded at:

<http://www.aorja.com/support/software.html>

12-1-1 USB DRIVER

To enable PC control, the USB driver for the AR6000 needs to be installed.
You can download the latest driver from the USB device manufacturer's website at:

<http://www.ftdichip.com/ftdrivers.htm>

Click "VCP Drivers" and then select version corresponding to your operating system.

The following are the specifications for the communication protocol.

Communication speed: 115,200 bps (default), 57,600 bps, 38,400 bps, 19,200 bps, 9,600 bps

Data: 8 bit

Stop bit: 1

Parity: None

Flow control: None or RTS/CTS

Echo: Off

Return Code: (PC→ AR6000): <CR>(0x0d) <LF> ignore

Return Code: (AR6000→ PC): <CR><LF>(0x0d, 0x0a)

Refer to the AR6000 control command list for details for PC control.

13 SPECIFICATIONS

GENERAL

Frequency range	9kHz to 6 GHz
Frequency resolution	1Hz (2Hz - Frequency above 3.15GHz)
Tuning steps - program	1Hz to 999.999kHz (2Hz - Frequency above 3.15GHz)
Receiving mode	USB/LSB, CW, AM, FM, WFM, FM-Stereo, APCO P-25 Optional
Number of VFO	5 (A through E)
Memory channel	2,000 channels (50 channels x 40 Memory banks)
Memory bank	40 banks (each bank can be customized between 5 to 95 channels)
Pass frequencies	1,200 frequencies or 1,200 frequency ranges 30 frequencies(ranges) x 40 banks
Priority channel	1 (one)
Selected memory channel	100 channels through memory banks
Typical scanning speed	Approx. 100 channels/steps per second
Antenna impedance	50Ω
Operating temperature range	0°C to +50°C / 32°F to 122°F
Frequency stability	Less than ±0.1ppm after warm-up (5 minutes). Less than ±0.01ppm with optional GPS unit.
Power supply requirement	10.7V to 16V DC, 2.0A @ 12V
Audio output	> 1.5W 10% T.H.D. (8Ω)
Power consumption *	Stand-by: 400mA, Max. Audio : 1.5A
Dimensions *	304mm(D) x 220mm(W) x 97mm(H)
Ground system	Negative ground
Weight*	5kg. (11 lb.)

RECEIVER

Receiver system	9kHz - 25MHz	Direct conversion
	25MHz - 220MHz	Double conv. super-heterodyne
	220MHz - 360MHz	Triple conv. super-heterodyne
	360MHz - 3.15GHz	Double conv. super-heterodyne
	3.15GHz - 6GHz	Down conversion
Intermediate frequencies	1st - 321.95MHz / 1.32145GHz	
	2nd - 45.05MHz / 321.95MHz	
	3rd - 45.05MHz	
Third-order IMD (IP3)	> +20 dBm at 14.1MHz	Pre-selector off
Typical Value	> +6 dBm at 50MHz	Preamp off
	> +8 dBm at 620MHz	"
	> 0 dBm at 1250MHz	"
	> +3 dBm at 2450MHz	"
Spurious and image rejection	> 70dB for 40kHz - 25MHz	Preamp off
	> 50dB for 25MHz - 2GHz	"
	> 40dB for 2.0GHz - 3.15GHz	"
Noise Figure (NF)	> 7dB for 25MHz - 1GHz	Preamp on
Typical Value	> 10dB for 1GHz - 2.75GHz	"
	> 12dB for 2.75GHz - 4.6GHz	"
	> 14dB for 4.6GHz - 5.8GHz	"
	> 18dB for 5.8GHz - 6GHz	"

Sensitivity (Specifications not guaranteed for received frequencies below 40kHz.)

Mode	SSB, CW	AM	FM	WFM
Test Method	10dB S/N	10dB S/N	12dB SINAD	12dB SINAD
Filter B/W	3kHz	6kHz	15kHz	200kHz
40kHz to 50kHz	6.0μV	15.0μV	/	
50kHz to 60kHz	4.0μV	10.0μV		
60kHz to 80kHz	3.0μV	7.0μV		
80kHz to 100kHz	1.5μV	4.0μV		
100kHz to 25MHz	0.7μV	2.0μV	0.4μV	1.5μV
25MHz to 2.75GHz	0.5μV	1.0μV	0.6μV	2.5μV
2.75GHz to 3GHz	0.7μV	1.7μV	0.6μV	2.5μV
3GHz to 3.15GHz	1.5μV	4.0μV	0.6μV	3.5μV
3.15GHz to 4.6GHz	/		0.5μV	
4.6GHz to 5.8GHz			0.7μV	
5.8GHz to 6GHz	/		1.5μV	

AUXILIARY FUNCTIONS

Simultaneous reception	Two types of simultaneous reception (dual-watch) are possible.
2 band reception	One HF (9kHz-25MHz) frequency plus one VHF/UHF(25MHz and above) frequency.
Offset reception	Main frequency plus sub-frequency (within ±5MHz from the center frequency) Offset reception is possible only for VHF/UHF.
Triple reception	Triple receptions are possible by combining simultaneous reception mode. I.E. One HF frequency plus offset reception.
Squelch system	CTCSS, DCS
Demodulation Aid	Auto Notch Filter (NOTCH), Noise Reduction (NR), Noise Blanker, IF Shift, CW Pitch, AGC, AFC, DTMF APCO (P-25) Phase 1 conventional mode only (optional)

AUDIO RECORDING

Type of recording	Record/Playback through SD or SDHC
SD card type	SD or SDHC card per SD Card Association More than 256MB is required. Use card adapter for miniSD and microSD cards. FAT16 and 32 only.
File Format	Windows(R) compatible WAV file format. RIFF (little-endian) data, WAVE audio, Microsoft PCM, 16-bit mono 17.578kHz
Recording time	Approximately 8 hours of continuous recording by 1GB SD Card. Squelch synchronization is possible to eliminate inactive time.

INPUT & OUTPUT

Antenna Input	ANT 1: 25MHz - 6 GHz, N female ANT 2: 9kHz - 3.15GHz, N female
10MHz reference input	SMA female Typical input: +2dBm for 50Ω
45.05MHz Analog IF output	BNC female, 45.05MHz±7.5MHz Typical output: Antenna input +10dB for 50Ω Frequency range 100kHz - 6GHz.
Digital I/Q output (Optional)	USB2.0 compatible isochronous transfer Digital I/Q output through USB Type-B Jack. Frequency range 100kHz - 6GHz.
12kHz offset output	12kHz offset analog I/Q Φ 3.5mm stereo-phone jack.
Line output	Φ 3.5mm stereo-phone jack.
Accessory	8-pin miniature DIN
DC Power Input	EIAJ MP-121C (5.5 x 2.1mm) plug. Positive center.
External speaker	Φ 3.5mm miniature phone jack (2-wire)
RS-232C	9-pin D-subminiature type (Male) - Firmware update and remote control by PC.
USB	USB Type-A; USB 1.1/2.0 Jack for PC control.
VIDEO output (Rear Panel)	RCA Jack, 75Ω 1V p-p

Specifications not guaranteed for received frequencies below 40kHz.

Specifications subject to change without prior notice for product improvement or modification.

Power consumptions, size and dimensions are only approximate values. Dimensions do not include projections. E. & O. E.

14 LIMITED WARRANTY (USA only)

AOR USA, Inc. (AOR) warrants its receivers as described below:

AOR will repair or exchange equipment as a result of defects in parts or workmanship for a period of one year from the date of original retail purchase from an authorized AOR dealer.

Exclusions

The following items are not covered by the AOR limited warranty:

1. Products that are damaged through accident, abuse, misuse, neglect, or user modifications.
2. Problems that arise through failure to follow directions in the owner's manual.
3. Exposure of the product to adverse or severe weather conditions, including lightening, temperature extremes or water, including rainfall or immersion.
4. Exposure to toxic materials, biohazards, radioactive materials or other contamination.
5. Repairs attempted by parties other than AOR or its authorized personnel.
6. Damage that results from improper installation, including improper voltage and/or reversed polarity, or exposure of a receiver to signal levels exceeding specifications.
7. Damage resulting through the use of accessories from manufacturers other than AOR.
8. Equipment that has had serial numbers removed or altered in any way.
9. Damage that occurred as a result of shipment. Claims must be presented to the carrier.
10. AOR is not responsible for any costs arising from installation or reinstallation of the equipment, nor for any consequential (such as loss of use) damage claims.

Obtaining Warranty Service

1. You are responsible for shipping the product to AOR and any related costs.
2. Warranty claim must be accompanied by a legible copy of the original product purchase receipt.
3. You must include a description of the problem(s) encountered with the product.
4. You must include your name, a valid ground shipping address (including zip code) and telephone contact information.
5. AOR will ship the repaired (or replaced) product by ground transport.

Limitations

Any and all implied warranties, including those pertaining to merchantability and utility for a specific purpose are limited to the duration of this limited warranty.

AOR's limits on warranty pertain only to the repair or, at its option, replacement of defective products. AOR shall not be liable for any other damages, including consequential, incidental or otherwise, arising from any defect.

Some states do not allow limitations on how long an implied warranty lasts and may not allow the exclusion of incidental or consequential damages. As such, the above limitations may not apply in every case. This warranty gives you specific legal rights and you may have other rights that apply in your state.

If you have questions about this limited warranty, or the operation of your AOR product, contact AOR at (310) 787-8615 during normal business hours (9 am ~ 5 pm Pacific Time Zone), or write to AOR, 20655 S. Western Ave., Suite 112, Torrance, CA 90501. You may also send a fax to AOR at (310) 787-8619. Additional information is available at the AOR web site: www.aorusa.com

We suggest attaching your purchase receipt to this half of the warranty card and keeping this information in a secure location.

AOR Model Number _____

Serial Number _____

Dealer Name _____

Purchase Date _____

**Manufacturer: AOR, LTD.
2-6-4, Misuji, Taito-Ku,
Tokyo, 111-0055, Japan
URL: www.aorja.com**

**US distributor: AOR USA, INC.
20655 S. Western Ave. Suite 112
Torrance, CA 90501
Phone: 310-787-8615
Fax: 310-787-8619
URL: www.aorusa.com
e-mail: info@aorusa.com**

Dec.15, 2017

Printed in Japan