

TB 11-6625-1636-35

Change 1

DEPARTMENT OF THE ARMY TECHNICAL BULLETIN

**CALIBRATION PROCEDURE FOR
ANTENNA COUPLER TEST SET AN/ARM-109
(NSN 6625-00-691-6594)**

Headquarters, Department of the Army, Washington, DC
29 April 1977

TB 11-6625-1636-35, 14 October 1975, is changed as follows:

Change the title as shown above

Page 5, paragraph 10a (3), line 2 "Vac" is changed to read: "VDC"

By Order of the Secretary of the Army:

Official

*PAUL T SMITH
Major General, United States Army
The Adjutant General*

**BERNARD W ROGERS
General, United States Army
Chief of Staff**

Distribution

To be distributed in accordance with DA Form 12-36A, Calibration requirements for AN/ARM-109

***TB 11-6625-1636-35**

DEPARTMENT OF THE ARMY / TECHNICAL BULLETIN

**CALIBRATION PROCEDURE
FOR
ANTENNA COUPLER TEST SET
AN/ARM-109
(NSN 6625-00-627-8592)**

**Headquarters, Department of the Army, Washington, DC
14 October 1975**

	Paragraph	Page
SECTION I. INTRODUCTION AND DESCRIPTION		
Purpose and scope	1	2
Reporting of technical bulletin improvements	2	2
Descriptive data	3	2
General instructions	4	2
Differences among models	5	3
II. EQUIPMENT REQUIREMENTS		
Equipment required	6	3
Accessories required	7	3
III. CALIBRATION PROCESS		
Preliminary procedure	8	4
Negative error	9	4
Positive error	10	5
Self-test circuit	11	5
Meter check	12	5
Input power	13	6
Rf load	14	7
Resistance check	15	7
Final procedure	16	7

**SECTION I
INTRODUCTION AND DESCRIPTION**

1. Purpose and Scope. This bulletin provides information for the periodic calibration of Antenna Coupler Test Set AN/APM-109 (fig. 1). It is to be used by

personnel trained and qualified in the use of calibration equipment.

*This bulletin supersedes TB 11-6625-1636-35/1, 18 July 1968.

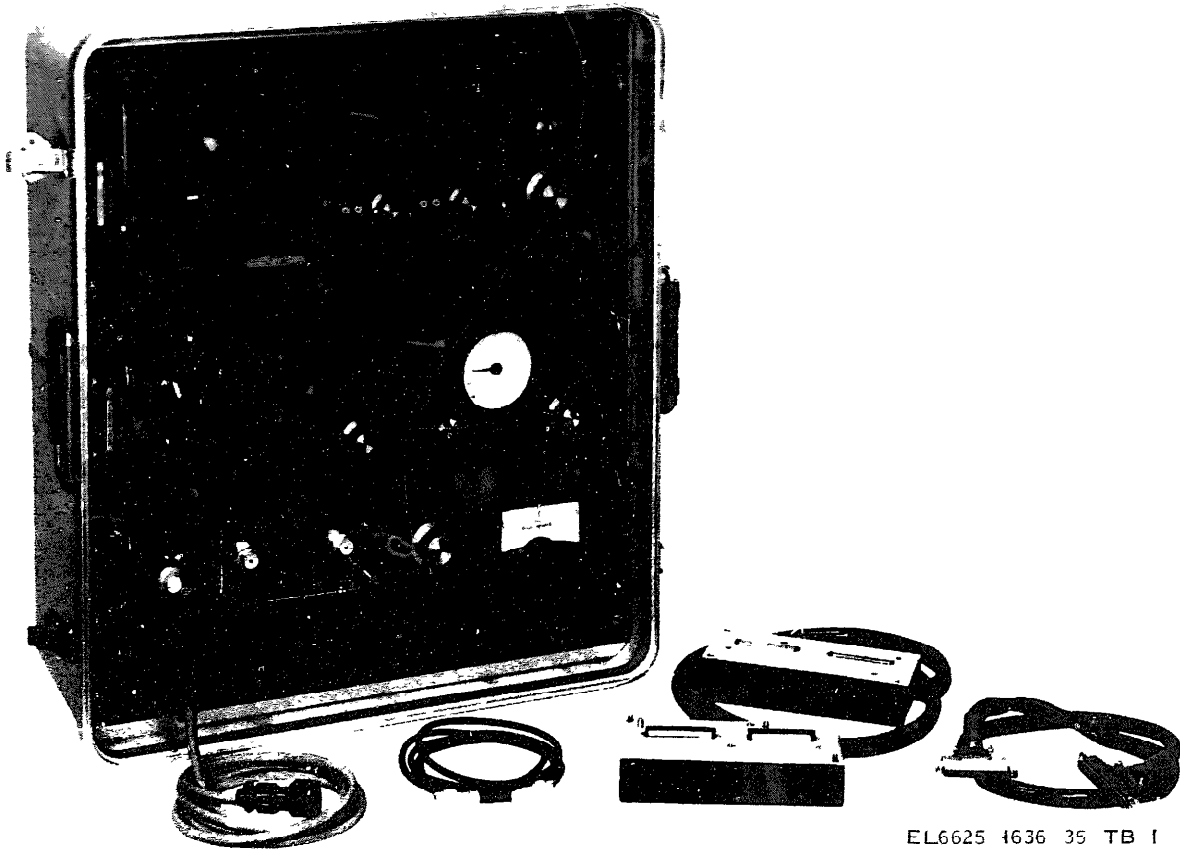

EL6625 4636 35 TB I

Figure 1 Antenna Coupler Test Set,
AN/ARM-109

2. Reporting of Technical Bulletin Improvements.

The reporting of errors, omissions, and recommendations for improving this bulletin is authorized and encouraged. Submit reports on DA Form 2028 (Recommended Changes to Publications and Blank Forms) and forward direct to Commander, US Army Electronics Command, ATTN: AMSEL-MA-Q, Fort Monmouth, NJ 07703.

3. Descriptive Data. Antenna Coupler Test Set AN/ARM-109 contains all material required to test the electronic modules of Antenna Couplers CU-1669/GRC and CU-1658/A.

Identification.

Nomenclature	Antenna Coupler Test Set AN/ARM-109
National stock number	6625-00-627-8592
Manufacturer	Collins Radio Company
Model number	9890H-1

Size	24 1/2 x 13 1/4 x 22 in (622 x 337 x 559 mm)
Weight	65 lbs (29.4 kg)
Reference	TM 11-6625-1636-15
b. Specifications.	
Duty cycle	Continuous, except for TS-2352/U, 5 minutes on and 5 minutes Off
Negative error	-0.212 ± 2.006V
Positive error	+0.100 ± 0.025V
TORQUE meter	90° ± 2°
Rf load	50 ohms at 30 mHz
c. Calibration.	
Time required	2 hours (approx)
Interval	In accordance with TB 43-180

4. General Instructions. a. Calibration Reporting.

(1) Forms, records, and reports required for calibration personnel at all levels are prescribed by TM 38-750. DA Form 2416 (Calibration Data Card)

must be annotated in accordance with TM 38-750 for each calibration performed.

(2) Adjustments to be reported on DA Form 2416 are designated (R) at the end of the sentence in which they appear. When the adjustments are in tables, the (R) will follow the designated adjustment. Report only those adjustments made and designated

with (R).

b. *Test Instrument.* Antenna Coupler Test Set AN/ARM-109 or its components Discriminator Test Set AN/ARM-118, Control Test Set AN/ARM-116, and Amplifier Test Set AN/ARM-117 will be referred to as the TI (Test Instrument).

5. Differences Among Models. None.

SECTION II EQUIPMENT REQUIREMENTS

NOTE

Minimum use specifications are the principle parameter required for performance of the calibration, and are included to assist in the selection of alternate equipment, which may be used at the discretion of the calibration, activity. Satisfactory performance of alternate items shall be verified prior to use. AU applicable equipment must bear evidence of current calibration.

6. Equipment Required. Equipment required for calibration performance tests is listed in table 1 and is referenced within the text by common name and item identification number prefixed A.

7. Accessories Required. Accessories required for calibration performance tests are listed in table 2 and are referenced within the text by common name and item identification number prefixed B.

Table 1 Equipment Required

Item Number	Common name	Minimum use specifications	Calibration equipment* (identifying number)
A1	Electronic Voltmeter	Range. -0.206 and -0.218 Vdc; +0.0975 Vdc and +0.1025 Accuracy $\pm 0.5\%$	ME-202/U or Dana, Model 5703-S-2127 (7912606)
A2	Multimeter	Range. 0 to 70 Vac RF, 2 MHz Accuracy $\pm 3\%$	ME-26B/U or H-P, Model 410C (7910902)
A3	Meter Test Set	Range 245 mV to 5 1V Accuracy: $\pm 0.5\%$	TS-682/GSM-1 (Espy Mfr, Model 3 180) or Fluke, Model 332B/AF
A4	Resistance Test Set	Resistance range: 0 1 M Ω to 11 M Ω Accuracy $\pm 1\%$	ESI, Model 230B (7912150-2)
A5	Rf Power Source	Range: 2 to 30 MHz, 50 volts RMS	AN/ARC-102 or MCL, Model 15009 (7912151-2)
A6	Rf Impedance Bridge	Ohms range 45 to 55 ohms Frequency range 30 MHz	ZM-61/U H-P/Boonton 250A RX Meter) or ESI Model 290A (794449-2)
A7	Power Source	Range 110 to 120 Vac, 1.8A, 400 Hz Accuracy $\pm 1\%$	NH Research, Model SF-613-1 (MIS10222)

*The calibration equipment utilized in this procedure was selected from those known to be available at Department of Defense facilities, and the listing by make or model number carries no implication of preference, recommendation, or approval by the Department of Defense for use by other agencies. It is recognized that equivalent equipment produced by other manufacturers may be capable of equally satisfactory performance in the procedure.

Table 2 Accessories Required

Item Number	Common name	Description (identifying number)
B1	Adapter Connector	UG-201A/U, BNC jack to N plug (10519457)
B2	Adapter Probe	MX-3341/U, connects ac probe to N jack and N plug (8899531)
B3	Cable Assembly	NSN 5995-00-557-7483
B4	Test Lead Set	CX-1331/U, 48 in, test prod to pin-plug, one black and one red

Item Number	Common name	Description (identifying number)
B5	Adapter Connector	UG-1441/U BNC male to binding posts (7909401)
B6	Adapter Box	Six binding posts (SKD4850-3)

SECTION III CALIBRATION PROCESS

8. Preliminary Procedure

NOTE

It is recommended that personnel familiarize themselves with the entire procedure before performing calibration,

- Position test instrument on its back.
- Remove SB-3100/ARM-109 Power Distribution Panel to gain access to power cables.
- Connect TS-2354/ARM-109 power cord to 115/Vrms, 400 Hz source. Refer to figure 2 for typical hookup.

- Insulate unused power cord plug on test instrument Power Distribution Panel.

CAUTION

Power source must be within $\pm 5V$ rms of 115V, ± 1 Hz of 400 Hz and waveshape must be sinusoidal for correct calibration.

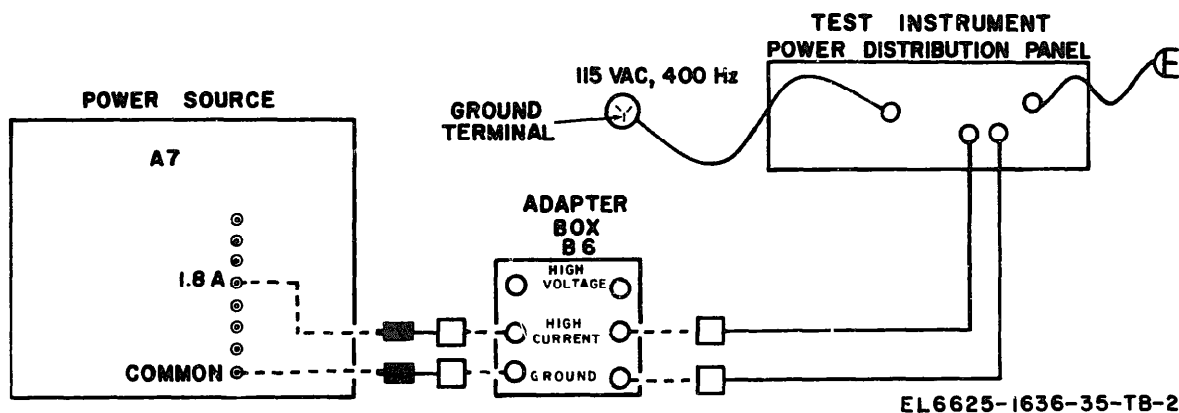

Figure 2 Typical 400 Hz power application.

- Check zero indicator of the Test instrument METER and adjust if necessary.

WARNING

HIGH VOLTAGE is used during the performance of this calibration. DEATH ON CONTACT may result if personnel fail to observe safety precautions.

NOTE

The following paragraphs are divided into subparagraph a, performance check, and subparagraph b, adjustments. When the performance check is within tolerance, do not perform the corresponding adjustment. When the performance check is not within tolerance, perform the corresponding ad-

justment before continuing with the calibration procedure. When the performance check is not within tolerance and the adjustment cannot bring it into tolerance, the deficiency must be corrected before continuing with the procedure.

9. Negative Error. a. Performance Check.

(1) Position the test instrument controls as follows:

- POWER switch to ON.
- OFF/SELF-TEST ON switch to ON.
- FUNCTION switch to 1.

(2) Connect electronic voltmeter (A1) to connector J1, pin 33 (fig. 3) and chassis ground using test lead set (B4).

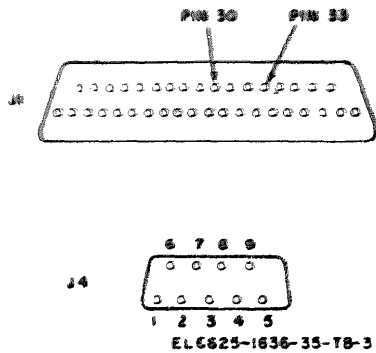

Figure 3. Test instrument connectors J1 and J4

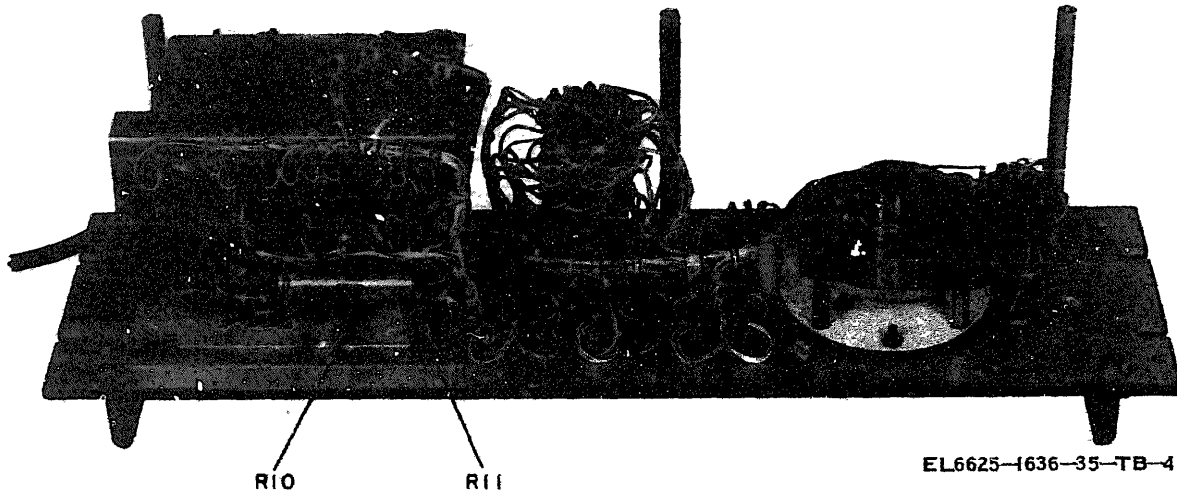

Figure 4 Negative and positive error adjustment

b. Adjustments.

(1) Deenergize test instrument and remove TS-2354/ARM-109 from protective case, if not previously removed.

(2) Energize test instrument and adjust (R11) (fig. 4) for an indication of +0.100 on the electronic voltmeter. (R)

(3) Carefully insert test instrument amplifier in carrying case.

11. Self-Test Circuit. a. Performance Check.

(1) Set test instrument POWER switch to OFF. Check for an indication on the TORQUE meter of 0.0 to +0.01 inch ounce (two needle widths is approximately 0.01 inch ounce).

(2) Turn test instrument OFF/SELF-TEST/ON switch to SELF-TEST.

(3) The electronic voltmeter will indicate between -0.206 and -0.218 Vdc.

b. Adjustments.

(1) Deenergize test instrument, remove TS-2354/ARM-109 from carrying case, and remove protective case.

(2) Energize test instrument and connect as in (2) above.

(3) Adjust R10 (fig. 4) for an indication of -0.212 Vdc on the electronic voltmeter. (R)

(4) Carefully insert test instrument amplifier panel in carrying case for next check. Do not fasten at this time.

10. Positive Error. a. Performance Check.

(1) Turn the test instrument FUNCTION switch to 2.

(2) Move the test lead from pin 33 to pin 30 of J1.

(3) The electronic voltmeter (A1) will indicate between +0.0975 and +0.1025 Vac.

(3) Set the POWER switch to ON and allow 5 minutes for warm-up.

(4) The TORQUE meter shall indicate between 0.39 and 0.41.

(5) Disconnect amplifier panel from 115V, 400 Hz power source.

(6) Reinstall amplifier in test instrument carrying case.

b. Adjustments. No adjustments can be made.

12. Meter Check. a. Performance Check.

(1) Set test instrument (or Discriminator Panel) in an upright position.

(2) Connect meter test set (A3) to the appropriate pin (fig. 3) of connector J4 (common to ground) as shown in table 3.

(3) Turn the test instrument **CIRCUIT SELECTOR** switch to the positions as shown in table 3.

(4) Adjust the meter test set for a full-scale indication to the left on the test instrument meter.

Readjust the meter test set for a full-scale indication to the right. In each case the meter set will indicate as shown in table 3.

b. *Adjustments* No adjustments can be made.

Table 3 Meter Test Settings

Test instrument		Meter test set	
CIRCUIT SELECTOR switch	J4 pin	Minimum	Maximum
PHASE	2	245 mV	255 mV
LOAD	1	245 mV	255 mV
REFL POWER	5	0.98V	1.02V
FWD POWER	6	4.9V	5.1V

13. Input Power. a. *Performance Check.*

(1) Connect the equipment as shown in figure 5.

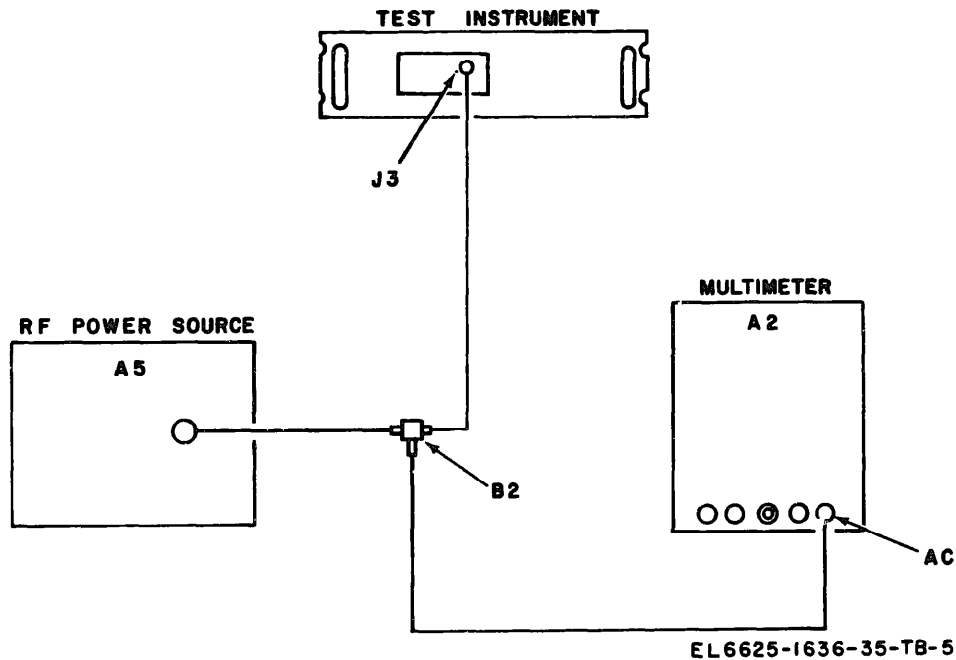

Figure 5 Input power check test setup

(2) Adjust Rf power source (A5) to a frequency of 2.000 MHz.

(3) Turn the test instrument **CIRCUIT SELECTOR** switch to **INPUT POWER**.

(4) Key the rf power source and adjust the output for 70V Rf (50) as indicated by multimeter (A2).

(5) The test instrument **METER** shall indicate

between 6 and 8 (4 and 6) scale, divisions.

b. *Adjustments.*

(1) Deenergize test instrument and remove TS-2352/ARM-109 from its protective case.

(2) Perform steps a (1) through (4) above.

(3) Adjust potentiometer **R2** (fig 6) for an indication of 7 (5) on the meter (R)

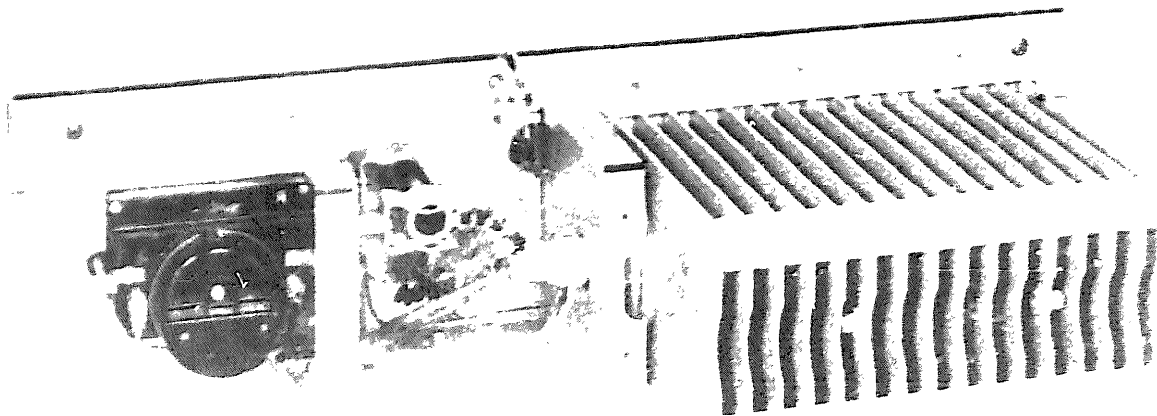

14. Rf load *a. Purpose Check*

1. Remove Discriminator Test Set AN ARM-118 from its protective case, remove the dust cover, and disconnect P1 connector from R5 (fig. 6).

NOTE

Make sure that the interconnecting coaxial cable between the Rf bridge and the test instrument is less than 12 inches long. In the absence of the Hewlett-Packard Boonton 250A RX Meter, substitute Resistance Test Set AN URM-90, and proceed to paragraph 15.

(2) Connect Rf impedance bridge (A6) to R5.

(3) Position the controls on the RF bridge for a frequency of 30 MHz, a parallel resistance of 50 ohms, and a parallel capacitance of 0 pF.

(4) Adjust the fine tuning of the Rf bridge for a sharp indication on the NULL meter.

(5) Move the connector from R5 to connector J3 on front of the test instrument. Reconnect Connector P1 to R5 and replace dust cover.

(6) Turn the test instrument CIRCUIT SELECTOR switch to LOAD and observe the NULL meter.

NOTE

The NULL meter will indicate a sharp null

with a parallel resistance setting of 50 ± 5 ohms.

b. Adjustments. Adjust C7 (fig. 6) on the test instrument for a sharp null. If necessary, adjust the parallel resistance control on the impedance bridge along with C7 to maintain the sharp null. Make sure that the parallel resistance setting is within tolerance (50 ± 5 ohms) (R).

15. Resistance Check. *a. Purpose Check.*

(1) Connect resistance test set (A4) between test instrument J3 and ground (outer J3) and measure the resistance.

(2) The resistance test set shall indicate between 45 and 55 ohms.

b. Adjustments. No adjustments can be made.

16. Final Procedure. *a. Deenergize and disconnect all equipment.*

b. Replace test instrument protective case.

c. In accordance with TM 38-750, annotate and affix DA Label 80 (US Army Calibration System). When the test instrument cannot be adjusted within tolerance, annotate and affix red tag, DA Form 2417 (Unserviceable or Limited Use Tag).

By Order of the Secretary of the Army:

Official:

PAUL T. SMITH
Major General, United States Army
The Adjutant General

FRED C. WEYAND
General, United States Army
Chief of Staff

Distribution:

To be distributed in accordance with DA Form 12-36A, (qty rqr block no. 815) Requirements for Calibration Procedures, AN/ARM-109.

END

7-18-83

DATE



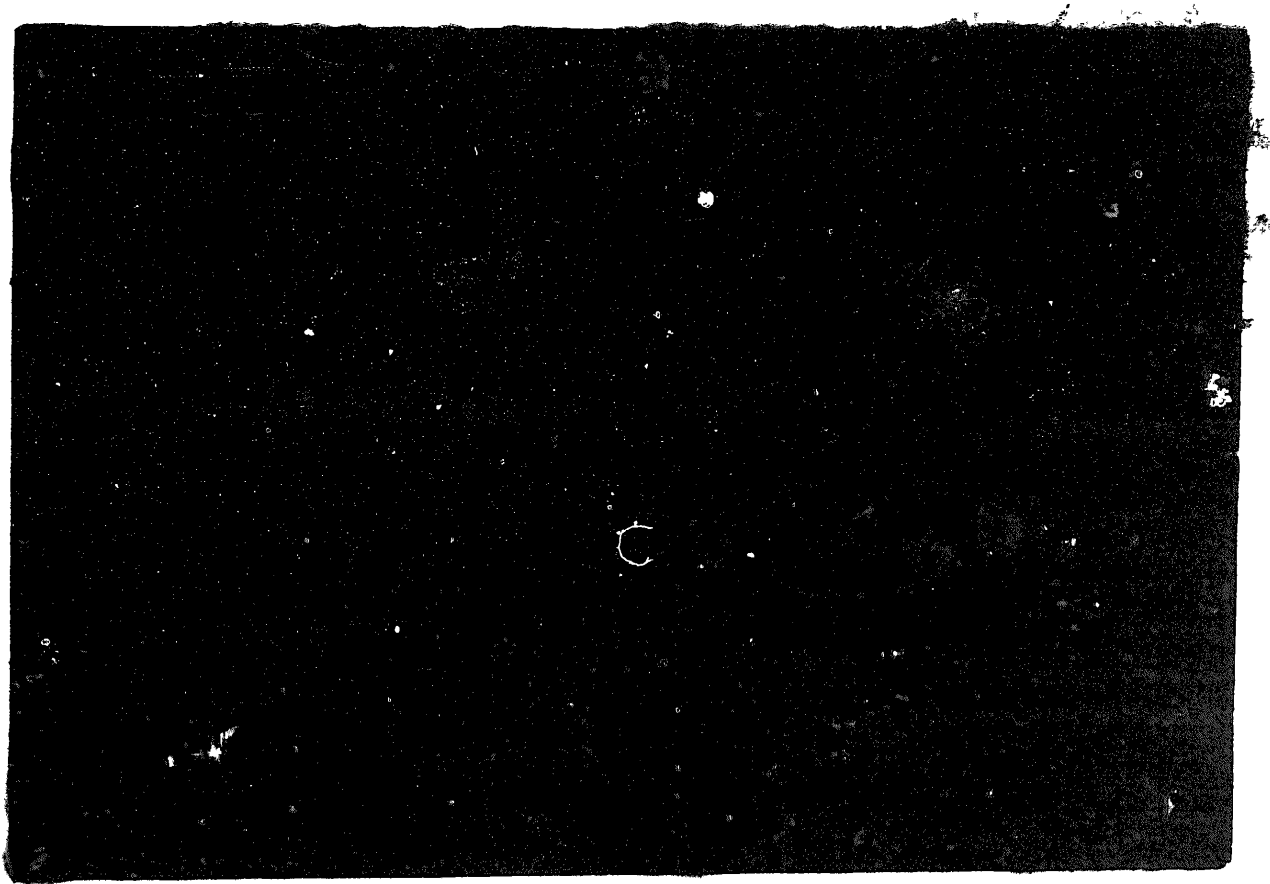

DEPARTMENT OF THE ARMY

MICROFORM TEST TARGET

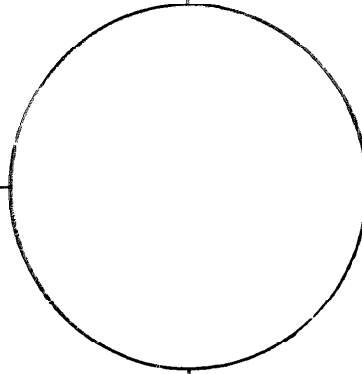
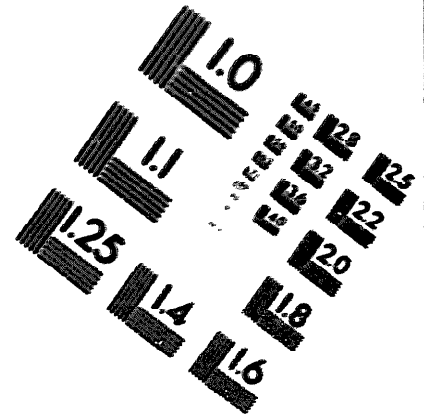
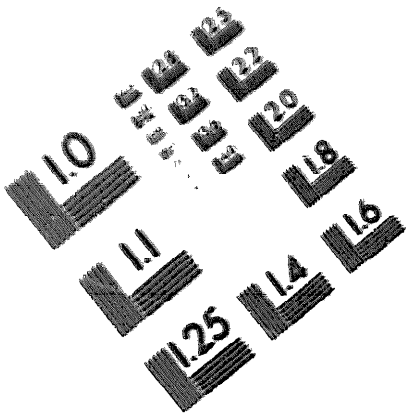

150 MM

0 mm (ø = 81 mm)

ABCDEFGHIJKLMN OPQRSTUVWXYZ 1234567890
abcdefghijklmnopqrstuvwxyz \$%&' /%# 1/2 1/4 3/4 —+ x&@*

1.5 mm (ø = 1.09 mm)

ABCDEFGHIJKLMN OPQRSTUVWXYZ 1234567890
abcdefghijklmnopqrstuvwxyz \$%&' /%# 1/2 1/4 3/4 —+ x&@*

2.0 mm (ø = 1.37 mm)

ABCDEFGHIJKLMN OPQRSTUVWXYZ
abcdefghijklmnopqrstuvwxyz
1234567890 \$%&' /%# 1/2 1/4 3/4 —+ x&@*

2.5 mm (ø = 1.77 mm)

ABCDEFGHIJKLMN OPQRSTUVWXYZ
abcdefghijklmnopqrstuvwxyz
1234567890 \$%&' /%# 1/2 1/4 3/4 —+ x&@*

10 mm (ø = 81 mm)

ABCDEFGHIJKLMN OPQRSTUVWXYZ 1234567890
abcdefghijklmnopqrstuvwxyz \$%&' /%# 1/2 1/4 3/4 —+ x&@*

1.5 mm (ø = 1.09 mm)

ABCDEFGHIJKLMN OPQRSTUVWXYZ 1234567890
abcdefghijklmnopqrstuvwxyz \$%&' /%# 1/2 1/4 3/4 —+ x&@*

2.0 mm (ø = 1.37 mm)

ABCDEFGHIJKLMN OPQRSTUVWXYZ
abcdefghijklmnopqrstuvwxyz
1234567890 \$%&' /%# 1/2 1/4 3/4 —+ x&@*

2.5 mm (ø = 1.77 mm)

ABCDEFGHIJKLMN OPQRSTUVWXYZ
abcdefghijklmnopqrstuvwxyz
1234567890 \$%&' /%# 1/2 1/4 3/4 —+ x&@*

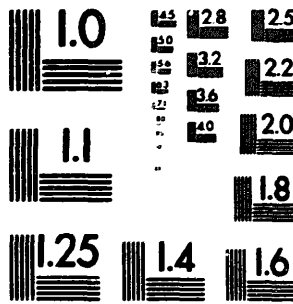

200 MM

250 MM

