

HF SSB transceiver type 8528
Operators handbook



No part of this handbook may be reproduced,
transcribed, translated into any language or transmitted
in any form whatsoever without the prior written
consent of Codan Pty Ltd.

© Copyright 1993 Codan Pty Ltd.

Codan Part No. 15-04016 Issue 4, April 1994



Contents

1. About this handbook.....	1-1
Who should use this handbook	1-1
Icons and standards.....	1-1
Glossary.....	1-2
2. Overview	2-1
The transceiver control panels	2-5
The transceiver and control head rear panel	2-9
3. Installation	3-1
Mounting the transceiver	3-3
Code 117 mounting cradle—front entry.....	3-4
Code 118 mounting cradle—top/bottom entry.....	3-5
Mounting the extended control head.....	3-6
Power supply	3-8
Grounding.....	3-9
Antennas and antenna tuners.....	3-9
4. Using the transceiver.....	4-1
Switching the transceiver on or off.....	4-2
Switching on or off without a PIN	4-2
Switching on or off with a PIN.....	4-3
The transceiver display	4-4
Option codes	4-4
Displaying the channel option.....	4-5
Dimming the display indicators	4-6
Reviewing the EPROM version and options.....	4-7

Selecting channels	4-9
Using the Channel Up or Down buttons.....	4-9
Using the recall buttons.....	4-10
Adjusting the volume	4-11
Using the clarifier	4-12
Changing the operating mode (USB - LSB)	4-13
Using the mute controls	4-14
Voice mute	4-14
Selective call mute	4-14
Tuning the antenna	4-15
Automatic tuning whip antenna.....	4-15
Multi-frequency tapped whip antenna.....	4-16
Antenna tuners	4-17
Tune receive only mode.....	4-19
Using the Tune Rx Frequency \wedge or \vee buttons	4-20
Selecting the desired frequency.....	4-21
Storing a tuned receive only frequency.....	4-23
Transmitting.....	4-24
Using the microphone	4-24
Transmitting a message.....	4-25
Making an emergency call (Australia only).....	4-27

5. Using selective call5-1

Selective call terms	5-2
Setting up selective call	5-4
Setting the pre-amble time period	5-5
Setting the fixed called address.....	5-6
Setting the self-identification address	5-7
Enabling the beacon mode	5-7
Setting tone calls	5-8
Setting up the selective call switches	5-9
Checking if a channel is enabled for selective call	5-10
Checking if a selective decode (SD) option is fitted.....	5-11
Selective call mute enable or inhibit.....	5-12
Enabling a channel for selective call.....	5-14
Transmitting a selective call	5-16

Receiving a selective call 5-19
 Answering a received call 5-21
 Returning a received call 5-22
 Reviewing the list of received calls in memory 5-23
 Reviewing calls held in memory 5-24
 Recalling calls held in memory 5-26
 Using the beacon feature..... 5-27
 Selective beacon mode 5-29
 (99) beacon mode..... 5-31
 Using the external alarm feature 5-33
 Testing the selective call functions 5-34

6. Using the receiver in scan mode 6-1

Scan mode terms..... 6-2
 Setting up the scan mode 6-3
 Programming the channels to be scanned 6-6
 Receiving in scan mode 6-8
 Start scanning 6-8
 Stop scanning 6-8
 Changing the scan mode..... 6-9
 Using selective call in scan mode 6-11
 Programming frequency band scan 6-13
 Scanning frequency bands 6-17
 Deleting unwanted scan channels 6-19

7. Programming channels 7-1

Setting up the P-channel inhibit options 7-2
 Checking if the inhibit link is fitted to the PCB 7-3
 Changing the inhibit options 7-5
 Copying channels to P-channels 7-7
 Creating receive only P-channels..... 7-10
 Creating transmit and receive P-channels 7-12
 Deleting unwanted P-channels 7-15
 Programming display messages 7-16
 Setting up temporary channels..... 7-18

8. Using tone call	8-1
Setting up tone call	8-2
Enabling a channel for tone call.....	8-5
Using the tone call mode	8-8
Transmitting a tone call.....	8-8
Receiving a tone call	8-9
9. Making a telephone interconnect call.....	9-1
Enabling the telephone mode.....	9-2
Making a telephone call.....	9-3
Sending a disconnect message	9-6
Storing a telephone number	9-8
Reviewing the stored telephone numbers.....	9-10
Calling a stored telephone number	9-12
Deleting a stored telephone number	9-15
Received call messages.....	9-17
Reviewing the list of received calls in memory	9-18
Returning a call.....	9-20
10. Operating with ARQ-FEC data.....	10-1
11. Changing the set-up options	11-1
Set-up option links.....	11-1
Front panel link.....	11-2
Changing the position of the front panel link	11-3
The microprocessor PCB link	11-4
Inserting the microprocessor PCB link	11-5
Reviewing set-up options.....	11-6
PTT timer	11-8
Enter a PIN (Personal Identification Number).....	11-10
Changing or deleting a PIN	11-12

Power-on settings.....	11-14
Mute settings.....	11-14
Beep volume	11-16
Clear all settings and P-channels	11-17
Antenna select output.....	11-18
12. Display messages	12-1
Messages and operator errors	12-2
System errors	12-7
Reviewing the EPROM program content.....	12-8
13. Front and rear panel sockets	13-1
Microphone socket	13-2
Options SD and PP - external alarm and battery.....	13-3
power outlet socket	
Option PS - miscellaneous facilities socket	13-4
Antenna control socket	13-5
Remote control socket	13-8
14. Specification.....	14-1
15. Options and accessories.....	15-1
Appendix A—The 9300 ALE Controller	A-1
ALE operation	A-1
ALE station addressing.....	A-2
ALE scanning	A-2
ALE sounding.....	A-2
LQA exchange	A-2
Setting up the ALE system.....	A-3
Setting the self-identification address	A-4
Programming the channels to scan	A-6
Setting the preamble time period.....	A-8
Changing the sounding interval.....	A-9

Using the 9300.....	A-10
Scanning.....	A-10
Calling a remote ALE station.....	A-11
Making a selective call to an ALE station.....	A-10
Receiving an ALE call	A-12
9300 settings.....	A-13
Disabling the 9300 ALE Controller.....	A-19
Link establishment time	A-20
Limitations.....	A-21

List of drawings

Figure	Title	Page
2.1	Front panel control transceiver.....	2-11
2.2	Extended control head transceiver	2-12
2.3	The transceiver rear panel.....	2-13
2.4	The extended control head rear panel	2-13
3.1	Typical base station installation.....	3-1
3.2	Typical mobile installation.....	3-2
5.1	Selective call switches.....	5-9
9.1	Telephone interconnect block diagram	9-1
11.1	The front panel link.....	11-2
11.2	The microprocessor link.....	11-4







1. About this handbook

Who should use this handbook

This handbook is written for the person who installs and operates the Codan 8528 transceiver.

Icons and standards

The following icons and standards have been used throughout this handbook.

This icon...	Means...
	the subject is continued over the page.
	the end of a subject.
	this is a warning, and information associated with this symbol must be adhered to.
	a button on the transceiver.
	an antenna symbol used in drawings.

Glossary

AD	Antenna Driver
ARQ	Automatic Repeat Request
FEC	Forward Error Correction
LCD	Liquid Crystal Display
LSB	Lower Side Band
PIN	Personal Identification Number
PS	Miscellaneous facilities
PTT	Press To Talk
R	Remote
RFDS	Royal Flying Doctor Service (Australia only)
Rx	Receive
SD	Selective call Decode
Telstra	Telstra (formerly OTC Australia)
Tx	Transmit
USB	Upper Side Band



2. Overview

Your 8528 HF SSB transceiver employs the latest concepts in design and reliability for long range communications. It has been designed for 12V DC operation in fixed base and mobile installations.

There are two versions of the transceiver; one with front panel control and the other with extended control. The extended control unit consists of a transceiver and a separate control head which can be located up to 100 metres away from the transceiver.

The control head can also be used as an accessory with the front panel control version to enable local and extended control of the transceiver.

You operate the transceiver through the front control panel, or control head, which contains sealed membrane switches (or buttons) and a liquid crystal display (LCD). The LCD shows the selected channel number along with the transmit and receive frequencies. In addition, the display shows messages about the operation of the transceiver.

Continual research and development has produced different versions of the 8528 SSB HF transceiver. The different version means a later issue of EPROM which provides different operating features. To check the version of your transceiver, refer to section 4, *Review the EPROM version and options*. This issue of the handbook incorporates operating information for EPROM versions 4.1 to 4.3.

The main facilities and features of the transceiver are:

- channels
- selective call
- scanning
- free tuning receiver
- tone calling
- telephone interconnect
- ARQ-FEC.

Channels

Your transceiver has a capacity of 600 channels, these cover:

- transmit frequency range 2 MHz to 24 MHz
- receive frequency range 0.25 MHz to 30 MHz.

A maximum of 501 transmit and receive channels can be pre-programmed in the factory, or by an authorised Codan dealer. You, as a user, can program the remaining 99 channels from the front panel as P-channels.

Selective call

This facility allows you to transmit a call to a single transceiver or a group of transceivers. To receive a selective call, your transceiver must be fitted with option SD.

Your transceiver can store details of up to ten stations that have called you while your transceiver was left unattended.

Scanning

This facility scans selected channels for audio signals. You can program a maximum of 15 channels to be scanned in sequence for audio signals. When a selective call decode option (SD) is fitted, a maximum of eight selective channels can be programmed and scanned.

Free-tuning receiver

Your transceiver can be used as a free-tuning receiver covering the world broadcast bands over the frequency range of 250 kHz to 30 MHz.

Tone calling

This facility allows you to send a tone call (two tones transmitted simultaneously) to signal another transceiver.

Telephone interconnect

A base transceiver can be connected to an IPC-500 telephone interconnect. This allows you to use your transceiver to make telephone calls into the public telephone system.

ARQ-FEC





For remote data transmission applications, your transceiver can be connected to a data source comprising computer terminal and interface modem. There are two types of transmission available:

- ARQ - Automatic Repeat Request
- FEC - Forward Error Correction.







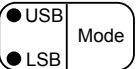

The transceiver control panels

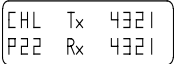



The front panel control transceiver (figure 2.1 on page 2-11) and the extended control transceiver (figure 2.2 on page 2-12) have the following control panel designations:

Item No.	Item	Function
1		Transmits either a selective call or tone call on the selected channel.
2		Transmits a tone alarm call on selected frequencies operating within the Royal Flying Doctor Service of Australia.
3		Switches the transceiver on or off.
4		Transmits a carrier signal so that antenna tuners and automatic antenna systems can be tuned.
5		Sets the transceiver to accept programmed information.
6		Selects USB or LSB mode. The indicators show which side band is selected.



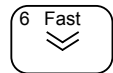
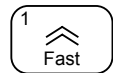
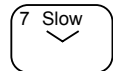
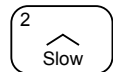

Item No.	Item	Function
7		The indicator is lit when the transceiver is transmitting.
8		Liquid Crystal Display (LCD) shows the channel number and frequency. It also shows messages regarding the operation of the transceiver.
9		Selects either channel or band scan. The indicator is lit when the scan mode is 'on'.
10		Mutes all audio until a selective call is received (option SD required). The indicator is lit when the mute is 'on'.
11		Removes normal background noise when there is no audio signal. The indicator is lit when the mute is 'on'. In addition, it switches the selective call mute off.
12		Shows the options programmed for the selected channel exhibited on the LCD. It is also used to interrogate received selective call memory.
13		Microphone socket.

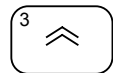

Item No.	Item	Function
14		Loudspeaker.
15		Selects a specific channel when used with the numeric buttons. Dims the display and indicators when pressed twice within one second.
16		Reduces the programmed frequency in steps of 1 kHz. It also keys in number 6.
17		Raises the programmed frequency in steps of 1 kHz. It also keys in number 1.
18		Reduces the programmed frequency in steps of 100 Hz. It also keys in number 7.
19		Raises the programmed frequency in steps of 100 Hz. It also keys in number 2.
20		Reduces the received audio frequency in steps of 10 Hz to help clarify the received speech. It also keys in the number 8.
21		Raises the received audio frequency in steps of 10 Hz to help clarify the received speech. It also keys in number 3.

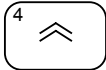

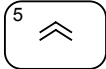





Item No.	Item	Function
22		Selects the next lower channel. It also keys in number 9.
23		Selects the next higher channel. It also keys in number 4.
24		Decreases the audio volume. It also keys in the number 0 and the letter P.
25		Increases the audio volume. It also keys in number 5.

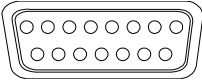
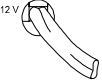

The transceiver and control head rear panel

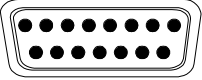
The front panel control and extended control head transceivers rear panels (figures 2.3 and 2.4 on page 2-13) show the following items:

Item No.	Item	Function
1		Antenna socket.
2		Earth (ground) screw.
3		Automatic antenna control socket.
4		12V DC power lead.
5		External 8 ohm loudspeaker socket. You can still use the internal speaker with an external speaker connected.
6		Remote control unit socket.
7		External alarm, battery power output and the miscellaneous facilities socket position.



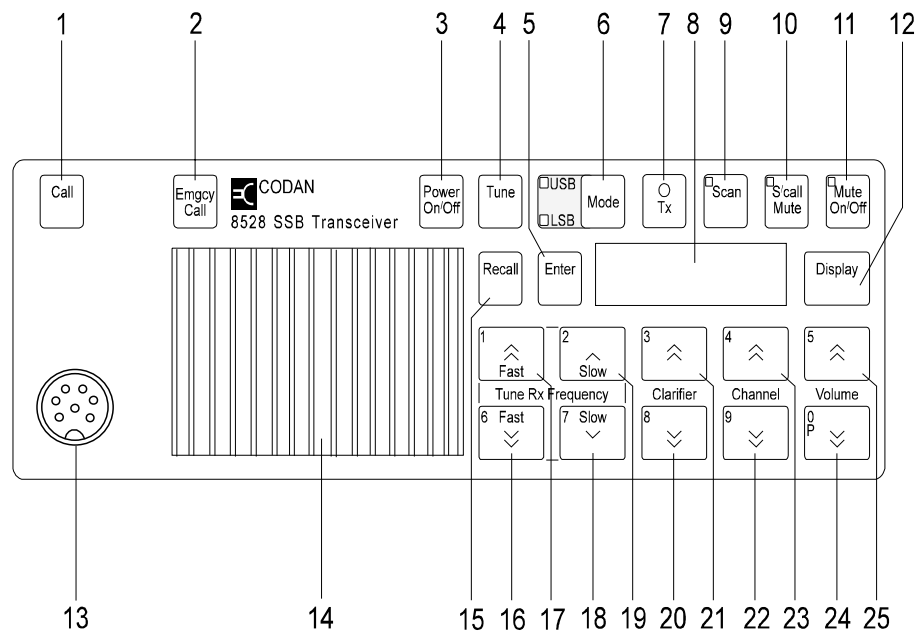

Figure 2.1: Front panel control transceiver

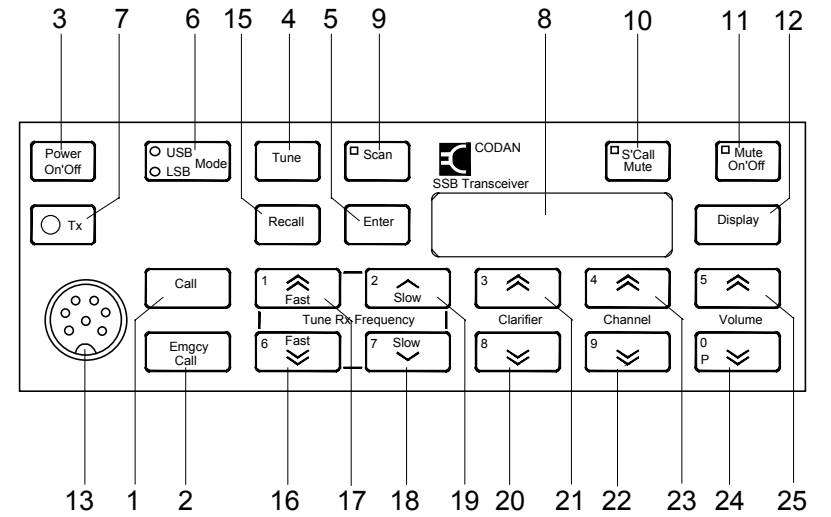

Figure 2.2: Extended control head transceiver

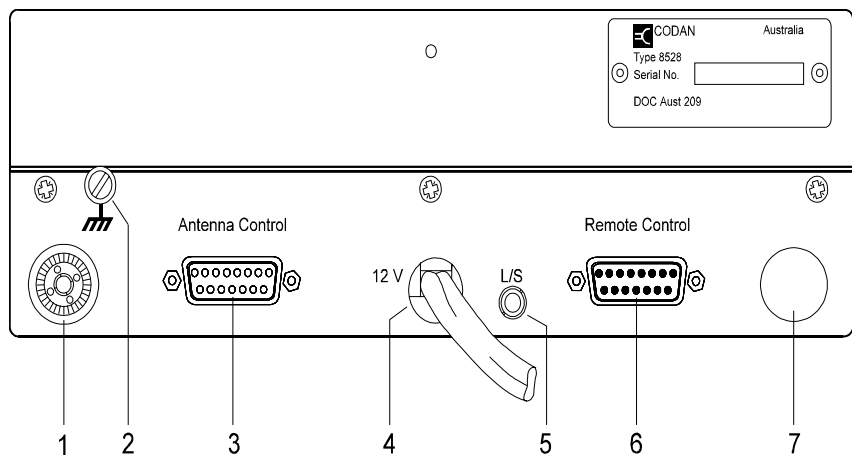

Figure 2.3: The transceiver rear panel

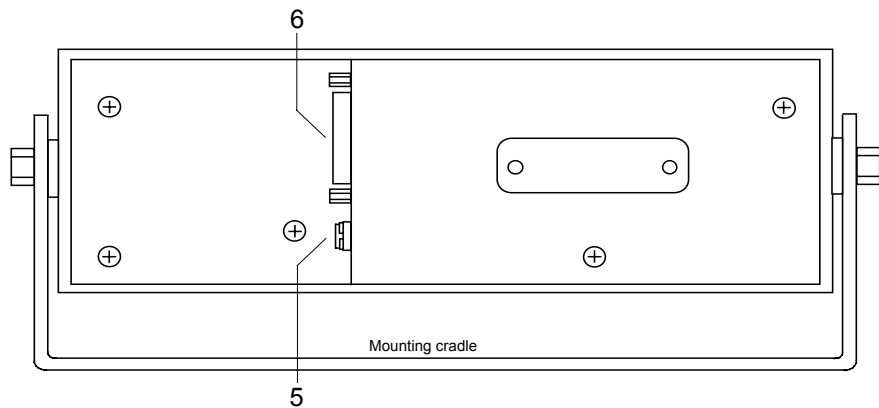

Figure 2.4: The extended control head rear panel

3. Installation

On receipt of your transceiver, check the contents against the packing list. Ensure all items are available before commencing installation.

The following notes provide guidance to installation but are not intended to be comprehensive procedures. It is recommended that installation is carried out by qualified and experienced personnel.

There are two types of installation:

- fixed base station
- mobile.

Fixed base station

The fixed base station installation (figure 3.1) typically consists of an AC power supply connected directly to the mains. DC output from the power supply is connected to the transceiver, which in turn is connected to an antenna.

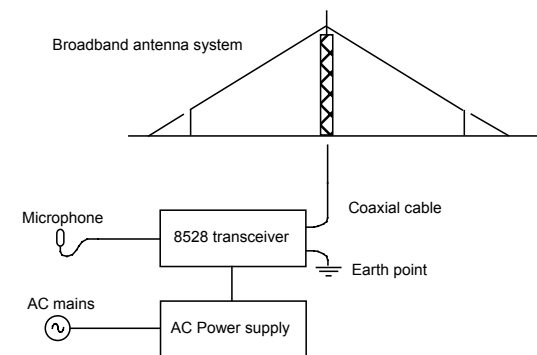

Figure 3.1: Typical fixed base station installation

Mobile

The mobile installation (figure 3.2) typically consists of a 12V DC power supply (battery) connected to the transceiver; the antenna is connected to the transceiver with coaxial cable and, for auto tuning antennas, with a control cable.

Installations may be either with front control transceivers or extended control transceivers which include a separate control head and speaker.

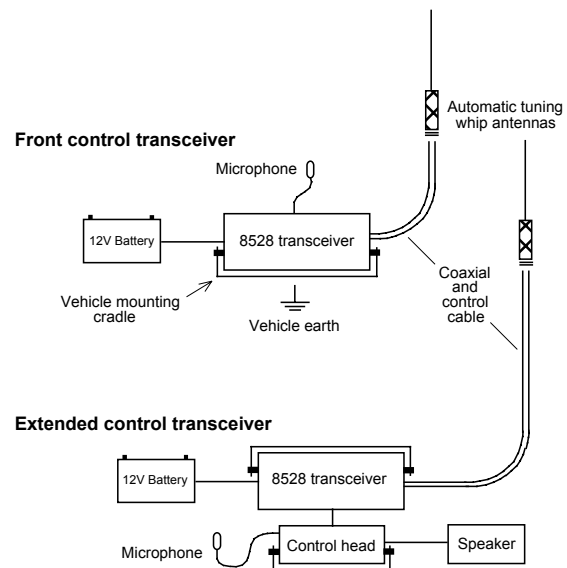

Figure 3.2: Typical mobile installation

Mounting the transceiver



In mobile installations, the transceiver must be mounted in a position that will not cause injury to occupants in the event of a motor vehicle accident.

Mount the transceiver and control head in a position that allows:

- **easy access to the control panel**
- **a free flow of air through the rear cooling fins.**

There are two types of mounting cradles that can be used when installing your transceiver:

- code 117 mounting cradle—front entry
- code 118 mounting cradle—top/bottom entry.

Both types of cradle (supplied with 6 metres of DC power cable) can be used to mount the transceiver. You must determine the mounting position to best suit your needs.

Code 117 mounting cradle—front entry

- Step** **Action**
1. The cradle can support the transceiver from above or below permitting roof or floor mounting.
- Secure the mounting cradle into position with the rotating cam catches to the front. Ensure there is sufficient space at the rear of the cradle to take the transceiver heat sink and connectors.

2. Align both cam catch slots with the T-section slides.

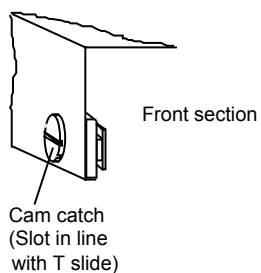

3. Insert the transceiver side rails into the T-section slides and push the transceiver fully into the cradle.
4. Apply gentle pressure to the front panel of the transceiver and lock into the cradle by turning the cam catches one quarter of a turn in either direction with a suitable tool or small coin.



Code 118 mounting cradle—top/bottom entry

- | Step | Action |
|------|---|
| 1. | Secure the mounting cradle into position with its spring clips nearest the front. Ensure there is sufficient space at the rear of the cradle to take the transceiver heat sink and connectors. |
| 2. | Remove the front and rear fixing screws of the transceiver side rails (the centre screw to be left untouched).

Note: Adaptor plates have to be fitted to the transceiver side rails to secure the transceiver to the cradle. |
| 3. | Secure the adaptor plates flush to the transceiver side rails with the new screws provided, and fit one 'O' ring over each projecting stud. The adaptor plates projecting studs fit into the slides in the cradle. |
| 4. | Insert the transceiver adaptor plate studs into the cradle slides and push fully into the cradle. |
| 5. | Secure the transceiver into the cradle with the spring clips. |



Mounting the extended control head



The control head must be connected to the transceiver before power is applied. Failure to do this may result in damage to the transceiver in the following ways:

- **the internal fuse blows and must be replaced**
- **the control head fails to operate. The power must be disconnected from the transceiver and then reconnected and switched on.**

Step	Action
1.	Remove the two cradle screws and washers securing the mounting cradle to the control head.
2.	Secure the mounting cradle into position. Ensure there is sufficient space at the rear of the cradle for the control cable.
3.	Secure the control head to the mounting cradle with the two screws and washers.
4.	Mount the transceiver (refer to <i>Mounting the transceiver</i> on page 3-3).



Step Action

5. Connect the interface cable between the control head and transceiver. Ensure the cable connectors are securely fastened to the control head and the transceiver.

Notes: The extended control head is supplied with a cable approximately 6 m long. To enable correct installation, the cable has different connectors at each end.

If necessary, remove the cover from one connector to pass the cable through restricted openings.

If the cable is too long, gather the excess neatly at one point.

6. Connect the extension speaker cable to either the control head or the transceiver.



Power supply

Ensure that the power supply to operate your transceiver is 12V DC. Transceiver series 8528H operating with the 400 watt PA (type 4404) will require a 24V DC supply.

Power can be provided by either a 12V battery (for mobile installations) or a suitable AC power supply (for base station installations).

All installations should be checked by a qualified technician before power is applied to the transceiver.

The heavy duty six metre length of power cable—supplied with the vehicle mounting cradle for mobile installations—has been selected to minimise the voltage drop between the battery and transceiver when in transmit mode. Installation using a smaller core cable size is not recommended.

All cables should be protected from sharp edges and mechanical abrasions.

For mobile installations, it is recommended that a suitable cartridge fuse (32 Amp-accessory code 711) is fitted in the active wire, close to the battery, to protect the power cable from the possible risk of fire through damaged insulation coming in contact with the vehicle chassis. Normal glass in-line automotive fuses are not recommended. The transceiver is fitted with adequate internal protection.

Connect the power cable between the transceiver and the battery or the transceiver and AC power supply.

Note: In extended control installations where the power and control cables are long and follow a common path, keep the cables separate by a minimum of 200 mm. The cables can be brought together for short distances, for example, to pass through the same hole in a bulkhead. Failure to observe this warning will cause distortion of the transmitted audio signals.



Grounding

In all installations an adequate ground, or earth, is essential for satisfactory operation of the transceiver.

A chassis ground or earthing position is provided on the rear panel of the transceiver.

The control head should also be earthed.

In fixed installations, install an earth cable between the transceiver ground screw and an earth point. Use copper braid or heavy duty cable.

Antennas and antenna tuners

Correct installation of these two units is of prime importance to the operation of your transceiver.

To obtain the best performance and good radiation efficiency from your transceiver installation, it is important to consider the physical location-distance from the transceiver-and earthing of the antenna and tuner.

Detailed and specific installation instructions are provided with each antenna and antenna tuner. These instructions must be used to gain the best possible results from your antenna, antenna tuner and transceiver.

4. Using the transceiver

This section covers the basic steps necessary to operate your transceiver.

It outlines how you use the control buttons to make various adjustments and settings, and includes transmitting and receiving calls.

Throughout this section all displays show examples of channel and frequency numbers. You must insert your selected channel and frequency numbers as appropriate.

Unless otherwise stated, it is assumed throughout this section that:

- the 12V DC power is supplied to your transceiver
- the front panel Power On/Off button is switched on.

Refer to *Switching the transceiver on or off* on page 4-2.





Switching the transceiver on or off

When you switch the transceiver on, the display usually shows the last settings before the transceiver was switched off. If your transceiver has a personal identification number (PIN) allocated, then the display will request you to enter your PIN.

This section covers two methods of switching your transceiver on or off:

- switching on or off without a PIN
- switching on or off with a PIN

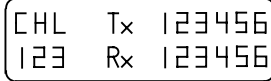

Switching on or off without a PIN

Step	Action...	Display shows...	Remarks...
1.	Ensure power is supplied to your transceiver.		
2.	Press 	You will see this display for one second  and then the last channel and frequencies selected 	The Mute and Mode indicators and the LCD display illuminate. The transceiver is turned on and automatically set to the last channel and volume settings used.
3.	To switch off, press 	The display and indicators go off.	The transceiver is turned off.

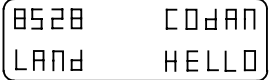
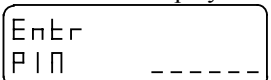
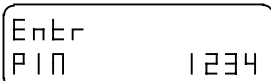

Switching on or off with a PIN

It is most important not to forget your PIN, otherwise you will never be able to switch on your transceiver. If this happens, you will have to return your transceiver to Codan for them to delete the allocated number.

Step	Action...	Display shows...	Remarks...
1.	Ensure power is supplied to your transceiver.		
2.	To switch on, press 	You will see this display for one second  and then this display 	The Mute and Mode indicators and the LCD display illuminate.
3.	Use the numeric buttons to enter your PIN.		You must enter the correct PIN, otherwise your transceiver will never turn on to the operating mode.
4.	Press 	The display is automatically set to the last channel and volume settings used.	The transceiver is turned on and can now be operated.
5.	To switch off, press 	The display and indicators go off.	The transceiver is turned off.



The transceiver display

The display provides you with visual indication of the selected channel numbers, and the transmit and receive frequencies. In addition, it shows you messages that will assist you when operating your transceiver. A detailed description of all the messages can be found in section 12, *Display messages*.

The display– and button legends of the control head– are back-lit to give you the clearest view. If necessary, the brightness can be adjusted to suit your needs, refer to Dimming the display and indicators on page 4-6.

This section explains what the option codes mean and how to reveal the option codes on the display.

The display contains two rows of information. Each row is split into three groups. What you see in each group depends on the transceiver mode selected.

Option codes

Code	Description
S	in the far left hand position indicates that selective call is enabled for this channel.
E	indicates that emergency calling has been enabled for this channel.
L	indicates the lower side band has been enabled for this channel.
U	indicates the upper side band has been enabled for this channel.
t1-4	indicates this channel has been programmed for tone calling. (Four tone pairs can be used, t1 to t4.)

Displaying the channel option

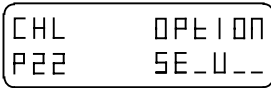

There are several options that you can select your transceiver to use. The display button gives you the freedom to check the options that have been selected (enabled) at the time of purchase by viewing the option bar in the display.

Step	Action...	Display shows...	Remarks...
1.	Press 		<p>The option bar indicates the options enabled for the channel currently selected.</p> <p>There are six spaces in the option bar that contain either a code (see Option codes) or an underscore (_). An underscore indicates that no function has been enabled.</p>



Dimming the display and indicators

The backlit display and indicators are at maximum brightness when you switch the transceiver on. This procedure explains how to reduce the brightness of the display and indicators.

Step	Action...	Display shows...	Remarks...
1.	Press  twice within one second		This reduces the brightness of the indicators and dims the display background lighting.
2.	To restore the brightness, press  again, twice within one second.		This restores both the display and indicators to their maximum brightness





Review the EPROM version and options

This facility allows you to review the EPROM version and some of the options fitted to your transceiver.

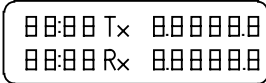
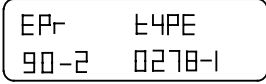
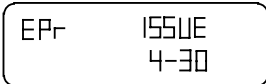
This procedure is repeated in section 12, *Reviewing the EPROM program content*.

Step	Action...	Display shows...	Remarks...
1.	Ensure your transceiver is switched on.		
2.	Press and hold down 	 at three second intervals the display changes and shows the following displays.	Displays lamp test: all segments must be on and all the indicators lit.
			This shows the Program (EPROM) type number (example 90-20278-1). Some indicator lamps will turn off.
			Program (EPROM) issue number. This is an example of EPROM issue 4.3.

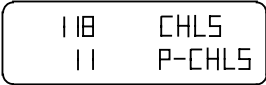
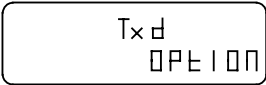
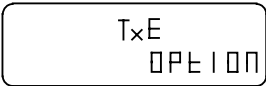
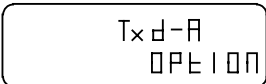
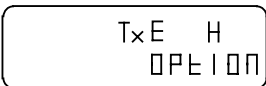

Step	Action...	Display shows...	Remarks...
2. cont.			<p>The top line shows the number of channels programmed by the factory or agent, this can be up to 501.</p> <p>The second line shows the number of channels programmed by the user, this can be up to 99 or 89 with the telephone mode enabled.</p>
	The following displays indicate some of the options fitted to your transceiver.		d indicates that the transceiver is inhibited from entering transmit frequencies from the front panel.
			E indicates that the transceiver is enabled for entering transmit frequencies from the front panel.
			A indicates that the transceiver is programmed for use on the amateur band.
			H indicates that the transceiver is set for use with an external power amplifier.
3.	Release the 		This switches off your transceiver.



Selecting channels

There are two methods of selecting channels:

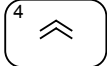
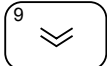
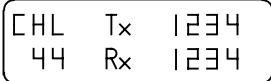
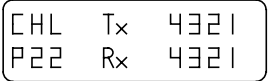

- Using the Channel Up or Down buttons—this method is preferable when you are changing to an adjacent channel
- Using the Recall button—since there may be up to 600 channels available, this method is preferable when you are changing channels over a large range.

Using the Channel Up or Down buttons

Step	Action...	Display shows...	Remarks...
1.	Press either of the Channel buttons  or 	The channel number selected appears in the lower left hand corner of the display, and the transmit and receive frequencies to the right.  Channels you have programmed from the front panel will have either an F or P in front of the number. 	Pressing these buttons moves to the next higher or lower channel. Keep the button pressed to move quickly through the channels. For details on F and P channels, refer to sections 6 & 7 respectively.

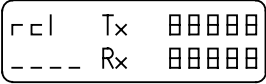
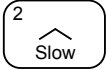
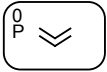
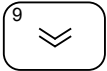
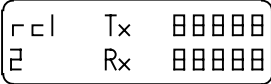
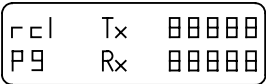

Using the recall button

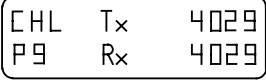



Step	Action...	Display shows...	Remarks...
1.	Press 		
2.	If the channel was installed by the factory, press  If the channel was installed by you, (F or P channels) press  and 	 	This is an example of how to recall channel 2. For details on F and P channels, refer to sections 6 & 7 respectively. This is an example of how to recall channel P9.
3.	Press 		The channel you selected will be recalled (in this case channel P9). If you enter an incorrect channel, the display shows the message 'NOT FOUND', and reverts to the next lowest programmed channel to the one you selected.
	Note: F numbers must always be selected as P numbers.		

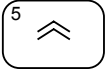

Adjusting the volume

This procedure tells you how to adjust the volume. When the mute is on, pressing any of the volume control buttons opens the mute for approximately one second. This allows you to hear the background noise, thus assisting you to select the correct level.





When you switch your transceiver on, the volume level is at the last used setting.

Step	Action...	Display shows...	Remarks...
1.	Press either of the Volume buttons  or 	The display does not change.	The  button increases the volume. The  button decreases the volume. You will hear a "pip" when the volume control has reached its operating limit.

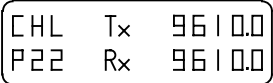

Using the clarifier

The clarifier buttons raise or lower the frequency in steps of 10 Hz. This allows you to fine tune the transceiver to obtain the best clarity for received voice calls.

Step	Action...	Display shows...	Remarks...
1.	Press either of the Clarifier buttons  or 		Alternate between the  and  buttons to obtain the best clarity. You will hear a "pip" when the clarifier control has reached its operating limit. Note: the clarifier resets to the mid range when you change channels, or switch off.



Changing the operating mode (USB - LSB)

Your transceiver has the facility to operate in either Upper Side Band (USB) or Lower Side Band (LSB) mode. You must have option L fitted and enabled on your transceiver on selected frequencies in order to use the LSB mode.

Unless otherwise advised, your transceiver is normally programmed to operate in the USB mode.

Step	Action...	Display shows...	Remarks...
1.	Press the mode button to switch between USB or LSB.	The display does not change.	The relevant indicator lights up.

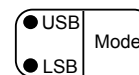

Using the mute controls

There are two mute controls that inhibit background noise until a signal is received:



- Mute On'Off—this function inhibits background noise until a voice signal appears.
- S'call Mute—this function inhibits background noise until your transceiver has been selectively called (this function is only available if your transceiver has option SD fitted).

Voice mute

Step	Action...	Display shows...	Remarks...
1.	To switch on and off press 	The display does not change.	The indicator is lit when this option is selected. Inhibits background noise until a voice call is received.



Selective call mute

Step	Action...	Display shows...	Remarks...
1.	To switch on press  to switch off press 	The display does not change.	The indicator is lit when this option is selected. Inhibits background noise until a selective call is received.





Tuning the antenna

Before using the selected channel, the antenna must be tuned to the transmission frequency. The procedure used to tune the antenna depends upon the type of antenna or antenna tuner you are using:

- automatic tuning whip antenna
- multi-frequency tapped whip antenna
- antenna tuner.

Automatic tuning whip antenna

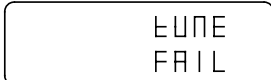
Step	Action...	Display shows...	Remarks...
1.	Select the required channel.		Refer to page 4-9, <i>Selecting channels</i> .
2.	Press 	<p>If tuning was successful</p>  <p>If tuning was unsuccessful</p> 	<p>The Tx indicator will be lit during this procedure. You will hear 'pips' while the antenna is tuning (this can take between 20 and 30 seconds). Once tuned successfully you will hear two high pitched 'pips'.</p> <p>If tuning is unsuccessful you will hear two low pitched tones. For further information, refer to the antenna handbook.</p>



Multi-frequency tapped whip antenna

For specific details on how to use the antenna, refer to the relevant antenna handbook.

Step	Action...	Display shows...	Remarks...
1.	Select the correct tap on the antenna to match the transmit frequency.	The display does not change.	The antenna will either have: <ul style="list-style-type: none">• the frequency printed next to the tap• a number that corresponds to a frequency on the list supplied with the antenna.



Antenna tuners

There are two types of antenna tuners, manual and automatic. For specific details refer to the relevant antenna tuner handbook.



Manual

Step	Action...	Display shows...	Remarks...
1.	Select the required channel.		Refer to page 4-9, <i>Selecting channels</i> .
2.	Press and hold  while adjusting the antenna tuner.	The display does not change.	



Automatic

There are two models of Codan automatic antenna tuners, the 4203 and the 9103. The 4203 will produce display messages on the transceiver; the 9103 will not. Further information on these antenna tuners can be found in the relevant handbooks.

Step	Action...	Display shows...	Remarks...
1.	Select the required channel.		Refer to page 4-9, <i>Selecting channels</i> .
2.	Press 	<p>If tuning on model 4203 was successful</p>  <p>If tuning on model 4203 was unsuccessful</p>  <p>For the 9103, the display is unchanged throughout this procedure.</p>	<p>The Tx indicator will be lit during this procedure.</p> <p>You will hear 'pips' while the antenna is tuning (this can take between 20 and 30 seconds).</p> <p>Once tuned successfully you will hear two high pitched 'pips'.</p> <p>If tuning was unsuccessful you will hear two low pitched tones. For further information, refer to the antenna handbook.</p>



Tune receive only mode

Your transceiver can be tuned to receive frequencies in the range 0.25 MHz to 30 MHz.



Note: Due to internally generated signals, it will be difficult to receive on and near frequencies 6599, 9998, 13199, 19799, 19995 and 26399 kHz.

While you are in tune receive mode you cannot receive selective calls or tone calls.







If the transceiver is used with an automatic antenna tuning system, the Tune button should be pressed to improve reception. If the transceiver is used with a manual tuner, the tuner controls should be set to the Scan settings.

Note: This is also recommended for transmit inhibit channels.

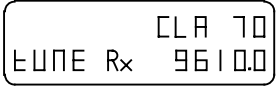
This procedure covers the two methods of changing the receiver frequency, and how to store a receive only frequency:

- using the Tune Rx Frequency  or  buttons—this method is preferable for small changes in frequency.
- selecting the desired frequency—this method is preferable for large changes in frequency
- storing a tuned receive only frequency.





Using the Tune Rx Frequency or buttons

Step	Action...	Display shows...	Remarks...
1.	Press and hold any Tune Rx Frequency button	The display scrolls through the numbers until you release the button. 	Use the Fast buttons for coarse tuning (1 kHz steps) and the Slow buttons for medium tuning (100 Hz steps). For fine tuning, the Clarifier  and  buttons can be used to make final adjustment in 10 Hz steps.
2.	There are three ways to exit this mode, either press the Channel  or  buttons, the  button, or the PTT button on the microphone.		



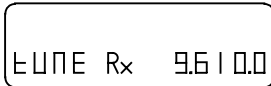

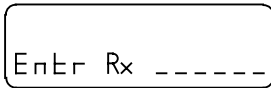
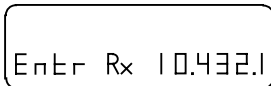
Selecting the desired frequency

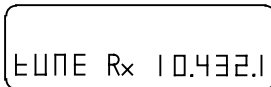
This procedure allows you to select the frequency you desire, and therefore save time. Once you have selected a frequency you have the option to store the frequency as a P-channel or exit this facility.

Step	Action...	Display shows...	Remarks...
1.	Press any Tune Rx Frequency button.		The display shows the last selected channel.
2.	Press 		Your next action must start within 60 seconds, otherwise you will have to repeat this procedure.
3.	Enter the frequency number using the numeric buttons.		The decimal point is automatically inserted by the transceiver. The example shows the display reading if you typed in 104321.
4.	Press  If required, you can fine tune reception by using the Tune Rx Frequency buttons.		The transceiver now receives this frequency. Note: after pressing the Enter button, the MHz decimal point disappears for frequencies below 10 MHz.





Step	Action...	Display shows...	Remarks...
5.	If you wish to store this selection as a P-channel, refer to the procedure <i>Storing a tuned receive only frequency</i> on page 4-23.		
6.	There are three ways to exit this mode, either press the Channel  or  buttons, the  button, or the PTT button on the microphone.		



Storing a tuned receive only frequency

You can store a tuned receive only frequency as a personal channel number in the range P1 to P99. This frequency can then be selected as outlined on page 4-9, *Selecting channels*.

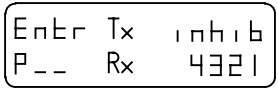
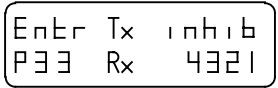
This procedure can only take place if your transceiver is in the tune receive only mode, as outlined on page 4-21 *Selecting the desired frequency*

Step	Action...	Display shows...	Remarks...
1.	Press the Enter button twice in rapid succession. 		The display will be different if you only press the Enter button once.
2.	Use the numeric buttons to enter a channel number you have selected between 1 and 99.		The P is automatically inserted. The example is given for number P33.
3.	Press 		The frequency is now stored as channel P33 and your transceiver has returned to the normal operating mode.



Transmitting

It is important when transmitting to use the microphone to its best advantage. By following the notes under *Using the microphone* you will obtain the best transmitting results. This section covers two topics:

- using the microphone
- transmitting a message.

Using the microphone

To connect the microphone to the transceiver; push the microphone plug gently into the microphone socket and fasten the locking ring finger tight, do not over tighten.

Please observe the following notes when using the microphone.

- Hold the microphone side-on and close to your mouth.
- Press and hold down the PTT (press to talk) button.
- When starting a transmission, always state the call sign of the person you are addressing and then your own call sign.
- Speak clearly at normal volume and rate.
- Do not use abusive language, remember others may be listening to your conversation and it can offend.
- Use the word 'over' to indicate you have finished speaking and release the PTT button.
- The transceiver has a 'time out' facility that stops the transmission after a pre-set period. This facility prevents problems occurring if you have jammed the PTT button down. The time out period can be adjusted to suit your requirements; refer to section 11, *Changing the set-up options*.

Transmitting a message

Step	Action...	Display shows...	Remarks...												
1.	Select a channel for transmission.	The display shows the channel number and the transmit (Tx), and receive (Rx) frequencies.	Refer to page 4-9, <i>Selecting channels</i> .												
2.	Check the display to see if the channel transmit frequency has been enabled.	<div style="border: 1px solid black; padding: 5px; display: inline-block;"> <table style="border-collapse: collapse;"> <tr> <td style="padding: 2px 10px;">CHL</td> <td style="padding: 2px 10px;">Tx</td> <td style="padding: 2px 10px;">4321</td> </tr> <tr> <td style="padding: 2px 10px;">P22</td> <td style="padding: 2px 10px;">Rx</td> <td style="padding: 2px 10px;">4321</td> </tr> </table> </div> <p>If the display shows 'inhib' then the channel frequency is for receive only purposes.</p> <div style="border: 1px solid black; padding: 5px; display: inline-block;"> <table style="border-collapse: collapse;"> <tr> <td style="padding: 2px 10px;">CHL</td> <td style="padding: 2px 10px;">Tx</td> <td style="padding: 2px 10px;">i n h i b</td> </tr> <tr> <td style="padding: 2px 10px;">P15</td> <td style="padding: 2px 10px;">Rx</td> <td style="padding: 2px 10px;">3600</td> </tr> </table> </div>	CHL	Tx	4321	P22	Rx	4321	CHL	Tx	i n h i b	P15	Rx	3600	<p>If the channel has been enabled, continue with step 3.</p> <p>If not and the display shows 'inhib' then you will have to select another channel on which to transmit.</p>
CHL	Tx	4321													
P22	Rx	4321													
CHL	Tx	i n h i b													
P15	Rx	3600													
3.	Tune the antenna.		Refer to page 4-15, <i>Tuning the antenna</i> .												
4.	Listen and check that the channel is free from traffic.														





Step	Action...	Display shows...	Remarks...
5.	Press the PTT button on the microphone and commence talking. Transmit your message following the notes outlined in <i>Using the microphone</i> on page 4-24.		The Tx indicator flashes during transmission.



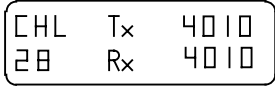

Making an emergency call (Australia only)

The Emergency Call button is used in Australia to call the Royal Flying Doctor Service. This button will only function if the selected channel is enabled for emergency calls.

Step	Action...	Display shows...	Remarks...
1.	Select the correct RFDS channel for the base station required. You can use the channel or recall buttons, then tune the antenna.		Refer to page 4-15, <i>Tuning the antenna.</i>
2.	Press  Keep pressing until you hear a single 'pip' (approx. two seconds), then release the button.		When you press the Emgcy Call button you will hear a tone. After the 'pip', the tone continues for 20 seconds. During this period the Tx indicator will be lit.
3.	If you hear a single low pitched tone and the display shows 'Not ENABLE', the channel is not an RFDS frequency and cannot be used for an emergency call.		Try again and select a correct RFDS channel.



Step	Action...	Display shows...	Remarks...
4.	Wait for a reply before transmitting your message.	The display does not change.	<p>If the call was received by an attended RFDS base, they will reply immediately.</p> <p>If the call was received by an unattended RFDS base, they will transmit a tone within two minutes.</p> <p>If the tone call is not received, you should try again or go to another channel.</p>
5.	<p>To cancel a call during the 20 second transmission time either press</p> <p></p> <p>the PTT switch on the microphone or</p> <p>the</p> <p></p> <p>button.</p>		



5. Using selective call

Selective call allows you to call an individual transceiver or a group of transceivers. This can be best likened to a normal telephone system where the called station has a unique calling address or number. However, the operator can also call a group of stations if desired.

Each transceiver has its own identification number. The identification number is a four digit code that is either:

- self programmed into the transceiver using the front panel buttons
- pre-set at the factory.

The selective call feature operates by the transmission and reception of coded signals. These signals contain the identification number of the transceiver being called (the called address) and the number of the transceiver making the call (the self-identification).

All 8528 transceivers can make selective calls. To receive a selective call however, option SD must be fitted to your transceiver.

All displays in this section show examples of channel and frequency numbers. You must insert your selected channel and frequency numbers.

Selective call terms

The following terms are used in this section.

This term...	Means...
Called address	The four digit identification number of the transceiver being called.
Beacon call	A call used to check signal conditions.
Decoding	Receiving and translating the encoded message.
Encode	The translation of the identification number and instructions into a coded message for transmission.
Group call	A call to all transceivers within a selected group. For example, a call using the identification address 0200 (group call) will be received by all transceivers whose identification address falls in the two hundred digit range (0201 to 0299).
Preamble	Part of the coded selective call message structure which is transmitted when you press the Call button. The message contains the preamble tone which precedes the called address and the self-identification address codes.
Program	Setting the identification addresses into the transceiver.



This term...	Means...
Revertive Signal	<p>A signal automatically transmitted back from the receiving transceiver to indicate message received and decoded satisfactorily.</p> <p>This signal does not apply to group calls.</p>
Selective beacon call	A call used to check signal conditions to a selected station.
Self-identification	The four digit identification number of the calling transceiver.
Station	A term used for the location of a transceiver, either mobile or fixed based.
Selective call encode only	<p>The transceiver can only transmit a selective call—NOT receive. There are two operating conditions that apply:</p> <ul style="list-style-type: none"> • front panel entry • pre-set controls.
Selective call encode/decode	<p>The transceiver, fitted with option SD, can transmit and receive a selective call. There are two operating conditions that apply:</p> <ul style="list-style-type: none"> • front panel entry • pre-set controls.



Setting up selective call

There are several features that need to be set up before selective call is used:

- the preamble time period
- the called address
- the self-identification address
- the beacon on or off.

You may cancel the procedure at any time by turning the transceiver off (press the Power On/Off button). Turning the transceiver off stores any changes you made to the features.

This procedure is only appropriate for transceivers with software issue 4.1 or greater. If you own a transceiver with a software issue before 4.1, this procedure will require you to reposition an internal link. Further information on this link can be found in section 11, *Changing the front panel link*.

Once you have commenced this procedure, if no action is required you can skip through all the features by repeatedly pressing the Call button.

Notes: A long preamble is required when scanning selective calls.

The reason for a long preamble is that during scanning, the preamble has to be present throughout the time it takes to scan all eight selective call channels.



Do not use identification addresses ending in '00' and '99' as they are used for the group call and beacon facilities.

You must always enter information within 60 seconds of pressing the Enter button, otherwise the transceiver reverts back to the normal mode.

Step	Action...	Display shows...	Remarks...
------	-----------	------------------	------------

Setting the preamble time period

1. Ensure your transceiver is switched off.

2. Hold down  and press 



Hold the Call button down for approximately three seconds. This turns the transceiver on and into the preamble set-up mode.

3. Press any of the numeric buttons to set the preamble length.



or



Pressing any of the numeric buttons alternates between a long or short preamble.

4. Press 

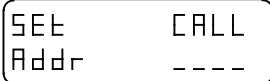

Once enter has been pressed, the pre-amble time has been set and can only be changed by repeating this procedure. If your transceiver has the pre-set selective calling switches fitted, proceed to step 6.



Step	Action...	Display shows...	Remarks...
-------------	------------------	-------------------------	-------------------

Setting the fixed called address

There are three ways of entering the called address:

- a) as below, which is fixed and cannot be changed easily
- b) using the pre-set switches - where applicable
- c) by the method used on page 5.16, *Transmitting a selective call* (Open access selective call) which allows the address to be entered from the front panel and is easy to change to call another transceiver.

Note: by setting a fixed called address the normal function of Call will change. If a fixed call address has been set, pressing Call will automatically send the programmed address. Open access selective calling is disabled.

5. Use the numeric buttons to enter the called address number.
- | | |
|------|------|
| SEE | CALL |
| Addr | 4835 |
- You can override an existing address by entering a new number.
- To delete an address, enter four zeros.

6. Press
- | |
|-------|
| Enter |
|-------|
- | | |
|------|------|
| SEE | SELF |
| Addr | ---- |
- Once Enter has been pressed, the called address has been set and can only be changed by repeating this procedure.
- If your transceiver has the pre-set selective calling switches fitted, proceed to step 8.
- The next step must be completed within 60 seconds.



Step	Action...	Display shows...	Remarks...
------	-----------	------------------	------------

Setting the self-identification address

7. Use the numeric buttons to enter the self-identification address number.



You can override an existing address by entering a new number.

To delete an address, enter four zeros.

8. Press 

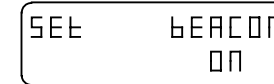

Once Enter has been pressed, the self identification address has been set and can only be changed by repeating this procedure.

The next step must be completed within 60 seconds.

Enabling the beacon mode

9. Press any of the numeric buttons to switch the beacon on or off.



or



Repeatedly pressing any of the numeric buttons switches the beacon on and off.

For more information on this feature, refer to page 5-27, *Using the beacon feature*.



Step	Action...	Display shows...	Remarks...
------	-----------	------------------	------------

10. Press 

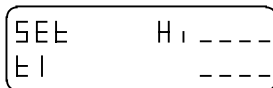

SEE HI ----
EI ----

This sets the new beacon setting and moves to the next feature (tone calling).

For more information on tone calling, refer to section 8, *Using tone call*.

Setting tone calls

11. This procedure is not required at this time.

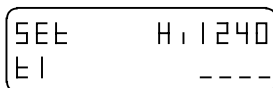

SEE HI 1240
EI ----

This procedure is covered in detail in section 8, *Setting up tone call*.

12. Press 

This turns your transceiver off and registers all the selective call settings you have just made.



Setting up the selective call switches

Some transceivers under special circumstances have selective calling ident code switches fitted within the transceiver. These are eight small rotary switches located on PCB 08-03300 or 08-03303 (refer to figure 5.1).

The *Self ident code switches* and the *Called address code switches* must all be set to allow you to transmit self and called identification addresses. It must be noted that the setting of the code switches overrides all front panel selection of the ident numbers from the transceiver, control head or remote control console 8570. With ALL the *Self ident* or/and *Called address code switches* set to zero (0), front panel selection of the ident numbers is re-established

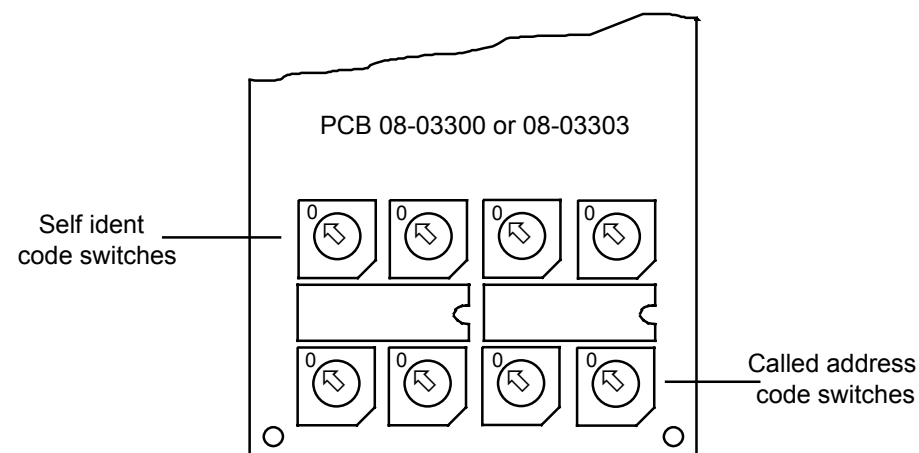
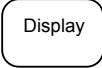

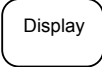

Figure 5.1: Selective call switches

Checking if a channel is enabled for selective call

A channel must be enabled for the selective call facility to operate. If the channel you wish to use has not been enabled, refer to the procedure *Enabling a channel for selective call* on page 5-14.

Step	Action...	Display shows...	Remarks...
1.	Press and hold 		An S in the left hand position of the options bar indicates that the channel is enabled for selective calling.
2.	Release 	The display will return to its original display in approximately one second.	



Checking if a selective decode (option SD) is fitted







Option SD must be fitted to your transceiver to receive selective calls.

Step	Action...	Display shows...	Remarks...
1.	Press 	The display does not change.	If the S'call Mute indicator lights, then option SD is fitted to your transceiver. However, if the mute has been inhibited intentionally the indicator will not light (refer to page 5-10).

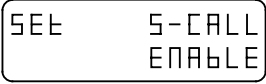

Selective call mute enable or inhibit

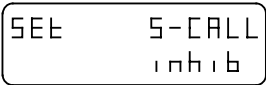
This facility enables or inhibits the operation of the S'call Mute button. When S'call Mute is inhibited, you cannot operate selective call mute. To complete this procedure, you must have option SD fitted to your transceiver (refer to page 5-13).

Step	Action...	Display shows...	Remarks...
1.	Turn the transceiver off and move the front panel link to position 1.	No display.	Before moving the link, note its original position. Refer to section 11, <i>Changing the position of the front panel link.</i>
2.	Hold down  and press 	Hold the S'call Mute button down until the display shows 	Repeatedly pressing S'call Mute will switch between ENABLE and inhib (inhibit).
3.	Press 		Stop at the selection you require.
4.	Press 	No display.	The transceiver is now switched off.



Step	Action...	Display shows...	Remarks...
5.	Return the front panel link to its original position (F or E).		Refer to section 11, <i>Changing the position of the front panel link.</i>
6.	Replace the cover before switching on your transceiver.		







Enabling a channel for selective call

This procedure explains how to enable an existing programmed channel for selective calling. To achieve this you are required to copy the existing programmed channel into the P-channel program, as outlined below.

This procedure is similar to *Enabling a channel for tone call* in section 8.

The displays in this section will vary depending on the channel you select.

Step	Action...	Display shows...	Remarks...						
1.	Use the Recall or Channel  and  buttons to find the channel you wish to enable.	<div style="border: 1px solid black; padding: 5px; display: inline-block;"> <table style="border-collapse: collapse;"> <tr> <td style="padding: 2px 10px;">[HL</td> <td style="padding: 2px 10px;">Tx</td> <td style="padding: 2px 10px;">4321</td> </tr> <tr> <td style="padding: 2px 10px;">29</td> <td style="padding: 2px 10px;">Rx</td> <td style="padding: 2px 10px;">4321</td> </tr> </table> </div> <p>An example for channel 29.</p>	[HL	Tx	4321	29	Rx	4321	Refer to section 4, <i>Selecting channels</i> .
[HL	Tx	4321							
29	Rx	4321							
2.	Press 	<div style="border: 1px solid black; padding: 5px; display: inline-block;"> <table style="border-collapse: collapse;"> <tr> <td style="padding: 2px 10px;">Enter</td> <td style="padding: 2px 10px;">Tx</td> <td style="padding: 2px 10px;">-----</td> </tr> <tr> <td style="padding: 2px 10px;">29</td> <td style="padding: 2px 10px;">Rx</td> <td style="padding: 2px 10px;">4321</td> </tr> </table> </div>	Enter	Tx	-----	29	Rx	4321	You will hear a 'pip'.
Enter	Tx	-----							
29	Rx	4321							
3.	Press 	<div style="border: 1px solid black; padding: 5px; display: inline-block;"> <table style="border-collapse: collapse;"> <tr> <td style="padding: 2px 10px;">Enter</td> <td style="padding: 2px 10px;">Tx</td> <td style="padding: 2px 10px;">4321</td> </tr> <tr> <td style="padding: 2px 10px;">29</td> <td style="padding: 2px 10px;">Rx</td> <td style="padding: 2px 10px;">-----</td> </tr> </table> </div>	Enter	Tx	4321	29	Rx	-----	You will hear a 'pip'.
Enter	Tx	4321							
29	Rx	-----							
4.	Press 	<div style="border: 1px solid black; padding: 5px; display: inline-block;"> <table style="border-collapse: collapse;"> <tr> <td style="padding: 2px 10px;">Enter</td> <td style="padding: 2px 10px;">OPT 00</td> </tr> <tr> <td style="padding: 2px 10px;">29</td> <td style="padding: 2px 10px;">---U---</td> </tr> </table> </div>	Enter	OPT 00	29	---U---	<p>You will hear a 'pip'.</p> <p>The display shows the individual options for the chosen channel.</p>		
Enter	OPT 00								
29	---U---								

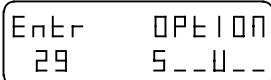

Step	Action...	Display shows...	Remarks...
------	-----------	------------------	------------

6. Press   You will hear a 'pip'!

Repeat this action until an S appears in the left hand position of the options bar.

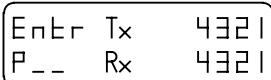
7. Press   You will hear a 'pip'!

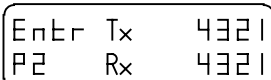
8. Use the numeric buttons to enter the 'P' channel number you wish to use.  You will notice that the display automatically inserts a 'P' to the number.

9. Press  

If the channel is already used the display shows

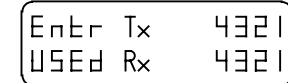



10. If the channel is already used, you can either enter another number or press Enter again to override the existing one. The display reverts back to normal. The information will either be stored under an existing channel number, or you will have created a new one.



Transmitting a selective call

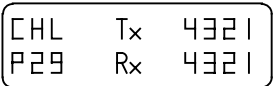

For selective call to operate you must have your self-identification number programmed, refer to *Setting the self-identification address* on page 5-7.

Step	Action...	Display shows...	Remarks...
1.	Select the required channel.		<p>Ensure the channel is enabled for selective call. Press the "Display" button to view the enabled options.</p> <p>If you need to enable the channel, refer to <i>Enabling a channel for selective call</i> on page 5-14.</p>
2.	Press  to turn the Mute On'Off to the off position.	The display does not change.	The indicator will go out, and you will hear background noise.
3.	Check that the channel is free from traffic. If the channel is busy; wait until the channel is free, or try another channel.	The display does not change.	You will need to listen for approximately 10 seconds to ensure the channel is free.



Step	Action...	Display shows...	Remarks...								
4.	<p>If your transceiver has the fixed, or pre-set selective calling switches fitted, press twice in succession</p> <div style="border: 1px solid black; padding: 2px; width: fit-content; margin: 5px auto;">Call</div>	<div style="border: 1px solid black; padding: 5px; display: inline-block;"> <table style="border-collapse: collapse;"> <tr> <td style="padding: 2px 10px;">CHL</td> <td style="padding: 2px 10px;">CALL</td> </tr> <tr> <td style="padding: 2px 10px;">P29</td> <td style="padding: 2px 10px;">1374</td> </tr> </table> </div> <p>This is an example of the called address identification number 1374.</p> <p>If the called address had been programmed, as described on page 5-6, then the permanent address will be displayed.</p>	CHL	CALL	P29	1374	<p>The Tx indicator will be lit and you will hear a 'warbling' sound for approximately 10 seconds.</p> <p>Proceed to step 8.</p>				
CHL	CALL										
P29	1374										
5.	<p>If your transceiver does not have the fixed called address programmed or pre-set selective calling switches fitted, press</p> <div style="border: 1px solid black; padding: 2px; width: fit-content; margin: 5px auto;">Call</div>	<div style="border: 1px solid black; padding: 5px; display: inline-block;"> <table style="border-collapse: collapse;"> <tr> <td style="padding: 2px 10px;">CHL</td> <td style="padding: 2px 10px;">CALL</td> </tr> <tr> <td style="padding: 2px 10px;">P29</td> <td style="padding: 2px 10px;">1374</td> </tr> </table> </div> <div style="border: 1px solid black; padding: 5px; display: inline-block;"> <table style="border-collapse: collapse;"> <tr> <td style="padding: 2px 10px;">CHL</td> <td style="padding: 2px 10px;">CALL</td> </tr> <tr> <td style="padding: 2px 10px;">P29</td> <td style="padding: 2px 10px;">----</td> </tr> </table> </div>	CHL	CALL	P29	1374	CHL	CALL	P29	----	<p>If the display shows the correct address, proceed to step 7.</p> <p>If no address, or an incorrect address is shown, continue with step 6.</p>
CHL	CALL										
P29	1374										
CHL	CALL										
P29	----										
6.	<p>Use the numeric buttons to enter the required selective call address number.</p>	<div style="border: 1px solid black; padding: 5px; display: inline-block;"> <table style="border-collapse: collapse;"> <tr> <td style="padding: 2px 10px;">CHL</td> <td style="padding: 2px 10px;">CALL</td> </tr> <tr> <td style="padding: 2px 10px;">P29</td> <td style="padding: 2px 10px;">1374</td> </tr> </table> </div>	CHL	CALL	P29	1374					
CHL	CALL										
P29	1374										

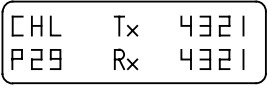

Step	Action...	Display shows...	Remarks...
7.	Press 		You will hear a 'warbling' sound for approximately 10 seconds.
8.	If the call was successfully received and decoded, within 25 seconds you will hear a revertive signal comprising of a number of short tones.		You will hear no sound if it was a group call. Normal transmission can now commence.



Receiving a selective call

Your transceiver must be fitted with option SD in order to receive selective calls. To check, press the S'call Mute button and with option SD fitted the S'call Call button indicator will light.

Step	Action...	Display shows...	Remarks...
1.	No action, the transceiver automatically completes this event.	 <p>When you receive a call the display changes to show you the self-identification address of the calling station.</p>	<p>When you receive a call, tones will be heard on the loudspeaker.</p> <p>You will hear a series of three telephone rings for selective calls, and 16 short 'beeps' for group calls.</p>

Notes: On receipt of a call you have two options:

- either answer it immediately, refer to *Answering a received call* on page 5-21
- let the transceiver automatically store the callers self identification number in memory to await your reply, refer to *Returning a received call* on page 5-22.

If your transceiver was unattended at the time the selective call was received, the callers self identification number is stored in memory for you to review at a later time. Refer to *Reviewing the list of received calls in memory* on page 5-23.

If you do not answer the call immediately, once the call is stored in memory your transceiver will continue to give out 'pips' every four seconds to indicate that a call has been received. If you wish to silence these 'pips', yet still retain the display, press the 'Display' button.

If you only wish to receive selective calls, ensure the S'call Mute button is operated and the indicator lit.



Notes: If the microphone PTT button is not pressed before the end of the tones:
cont.

- the called display will remain on to indicate that a call was received
- a 'pip' will be heard every four seconds
- the external alarm relay contacts will close for approximately two minutes (refer to page 5-33, *Using the external alarm feature*).



Answering a received call





This procedure is used when you want to answer a call that has just been received on your transceiver which is still producing the ringing tone.

Step	Action...	Display shows...	Remarks...
1.	The display shows the channel number and the identification address of the caller.		
2.	Press the microphone PTT button twice in succession.	The display either reverts back to the normal display or shows the details of the next (if any) unanswered calls.	<p>The first press of the PTT button cancels the call and the S'call mute.</p> <p>The second press of the PTT button allows you to transmit to the caller.</p> <p>Proceed to use the transceiver in the normal way..</p>

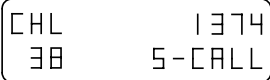

Returning a received call

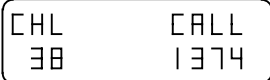
This procedure is used when you want to return a call that has been stored in the memory stack.

Step	Action...	Display shows...	Remarks...
1.	Select the call you wish to return. If necessary, tune the antenna.	 <p>The display shows the channel number and the identification address of the caller.</p>	Refer to <i>Reviewing the list of received calls in memory</i> on page 5-23.
2.	Press 		<p>The transceiver will automatically select the correct channel.</p> <p>The call details are now deleted from memory, but ready to transmit.</p>
3.	Check that the channel is free from traffic, then press 	The display shows the details of the next unanswered call.	<p>The transceiver sends the selective call and the transmit indicator will light.</p> <p>If the call is answered, proceed to use the transceiver in the normal way.</p> <p>The caller details are deleted when you press the PTT button on the microphone.</p>



Reviewing the list of received calls in memory

Your transceiver is able to record up to 10 calls in memory from various stations. These may be on different channels if your transceiver is on scan mode. These calls are recorded in a memory stack awaiting your review. If a station calls more than once on the same channel, your transceiver only records one of the calls. If more than 10 calls are made to your transceiver, the first call stored in memory is deleted to make room for the latest call.

Ensure your transceiver is not in the scan mode before commencing this procedure.



A permanent or brief loss of power to your transceiver will delete information stored in memory . Ensure you record or use all the information stored in the memory stack before switching off the transceiver.

Notes: If the transceiver power is lost momentarily (such as during starting the vehicle engine), the call memory is retained but the number is lost.

Switching the transceiver off using the Power On'Off button deletes all calls stored in the memory stack.



There are two methods of reviewing the list of received calls held in the memory:

- using the Display button to review all calls in the memory
- using the Recall button have direct recall of the called channel.



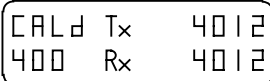

Reviewing calls held in memory

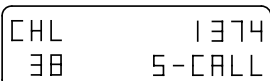
This procedure allows you to review all calls held in the memory in the order received. Ensure the transceiver is not in scan mode when reviewing the list of selective calls received.

If no calls have been made to your transceiver, the display will continue to show both the channel and frequency numbers.

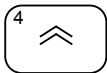
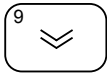
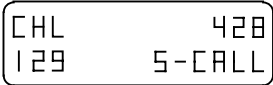
Step	Action...	Display shows...	Remarks...
1.	No action, this is what you will see on the display of your transceiver.		The last call recorded will be shown in the display.
	If scanning, and not on the channel that called, the display will show CALd.		
2.	To view the calls held in memory, press  twice within one second.		The first station to call will be displayed first. The display shows the callers identification code (1374) and the channel used (38).

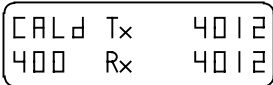





Step	Action...	Display shows...	Remarks...
3.	Press either  or 		Pressing  will change the display to show the next call, and  will reverse the order viewed. The identification address and corresponding channel number will change for each caller.
4.	If you wish to return a call, refer to <i>Returning a received call</i> on page 5-22.		
5.	To delete a call, press the PTT button on the microphone.	The display will show the next caller's details.	When you press the PTT button, the identification number in the display is deleted from memory. You can then select, call or clear the remainder of the calls from memory.
6.	If you don't clear all the calls, the display will show CALd until memory is empty.		If you are on the channel where the call was recorded, the display shown in step 1 will be on view.
7.	Press 	The display shows the standard display.	This returns the transceiver to normal operation.

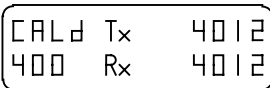

Recalling calls held in memory

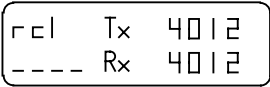
Ensure the transceiver is not in scan mode when recalling a selective call held in memory.

Step	Action...	Display shows...	Remarks...
1.	No action.		
2.	Press  and then 	 	
3.	Check that the channel is free from traffic, then press 	The display shows the details of the next unanswered call.	The transceiver sends the selective call.
4.	Once the recalled channel has been cleared, to recall other calls held in memory they have to be brought forward by repeating steps 2 and 3.		



Using the beacon feature

The beacon facility is used to check signal conditions between two transceivers fitted with selective call.

The beacon facility has two modes of operation:

- selective beacon mode
- base station (99) beacon mode.

Selective beacon mode

This facility is only available to transceivers with EPROM version 4.1 and above.

With the beacon facility enabled on a transceiver, it will transmit a beacon signal on receipt of a selective beacon call from another transceiver. Refer to the *Selective beacon mode* procedure on page 5-30.

Both transceivers must be on the same channel, or the receiver of the selective beacon call must be scanning through the same channel.

(99) beacon mode

The 99 beacon mode is recommended for use in base station applications and for those transceivers that may have operating selective call but do not have the beacon mode facility.

With a base station enabled for beacon mode, it will transmit a beacon signal on receipt of a selective call ending in 99. Refer to the *(99) beacon mode* procedure on page 5-31.

The thousand and hundred digits of the address must be the same for both the beacon transmitting and receiving stations.

If mobile transceivers have the beacon enabled, the first two digits of each mobile transceiver's self-identification address should be set to a different number so that they do not all transmit a beacon response together.



General information for both modes of operation

The beacon signal consists of four long tones.

Self-identification addresses ending in 99 should be avoided as these will cause confusion.



No alarm or call is recorded at the receiving transceiver, only the Tx indicator flashes.

If the receiving transceiver is in scan mode, the scan sequence recommences immediately.



Normal selective call operation is not affected.



Selective beacon mode



Step	Action...	Display shows...	Remarks...
1.	Ensure your transceiver is switched on.	The last channel selected.	
2.	Select the required test channel and tune the antenna.		Refer to section 4, <i>Selecting channels</i> .
3.	Press 		When this button is pressed, the S'call Mute is automatically switched off.
4.	Use the numeric buttons to enter the required selective call address number.		This allows you to send a selective call to a station whose address number is 1374.





Step	Action...	Display shows...	Remarks...
5.	Check that the channel is free from traffic, then press  (beacon call button)	 Immediately the call is received, the display shows the last channel and transmit & receive frequencies used.	The transmit indicator will be lit and you will hear a warbling sound for approximately 10 seconds. If the call is successfully decoded you will hear four long reverive tones. You can check these tones for signal strength and compare them with signal strengths from other channels. Select the channel giving the best return signal strength.



(99) beacon mode

Step	Action...	Display shows...	Remarks...
1.	Ensure your transceiver is switched on.	The last channel selected.	
2.	Select the required test channel and tune the antenna.		Refer to section 4, <i>Selecting channels</i> .
3.	Press 		When this button is pressed, the S'call Mute is automatically switched off.
4.	Use the numeric buttons to enter the required selective call number. Use the first two digits of the stations self identification number and ensure the last two are 99.		This will send a signal to the base station enabled for beacon call, whose four digit self ident address begins with 13.



Step	Action...	Display shows...	Remarks...
5.	<p>Check that the channel is free from traffic, then press</p>  <p>(beacon call button)</p>	 <p>Immediately the call is received, the display shows the last channel and transmit & receive frequencies used.</p>	<p>The transmit indicator will be lit and you will hear a warbling sound for approximately 10 seconds. If the call is successfully decoded you will hear four long reverive tones.</p> <p>You can check these tones for signal strength and compare them with signal strengths from other channels.</p> <p>Select the channel giving the best return signal strength.</p>



Using the external alarm feature

If your transceiver has option SD fitted, an external alarm facility is made available through the external alarm socket on the rear panel (refer to figure 2.3).

A pair of relay contacts are wired to the socket, which close for two minutes when your transceiver receives a selective call. The relay contacts can be used to operate an alarm bell or buzzer.

- Relay contact rating: 50V DC - 1 Amp
- Plug connections: pins 2 and 3.

Further details on the socket can be found in section 13.



These contacts must not be used to switch voltages greater than 50V, or loads that draw more than 1 Amp.





Testing the selective call functions

This is a special test mode which will not be required for normal operations.

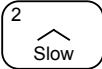

In this mode, the transceiver decodes all selective call signals, and displays the address to which it was sent and the self identification of the calling station.

No called alarms or revertives are generated. (A revertive is a signal transmitted back from the receiving transceiver to indicate message received and decoded satisfactorily.)

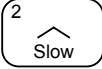
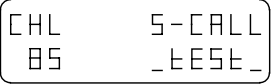
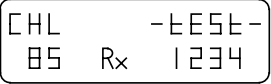
Ensure your transceiver is switched off before entering this mode.

Step	Action...	Display shows...	Remarks...
1.	Press and hold  and press 		Do not hold down the Power On/Off button, just the Slow button for approximately five seconds.
2.	Press  within 10 seconds of releasing the  button.		
3.	No action. After approximately five seconds the display changes.		The display stays the same until a selective call is received.



Step	Action...	Display shows...	Remarks...
4.	No action.		When a selective call is received, the display shows the called station identification address and the self identification address.
5.	To exit this mode, press 		You must switch your transceiver off and on again to clear this mode.



Using selective call



6. Using the receiver in scan mode

In the receiver scan mode your transceiver is able to listen into selected channels for transmitted signals. Once a signal has been detected, the transceiver holds that channel for a pre-selected time before continuing with the scan. This is determined at set-up.

In normal operating conditions, a maximum of 15 channels can be programmed to be scanned in sequence for audio (voice) signals. A maximum of 8 selective call channels can also be included but must be programmed within the first eight entries.

The scanning facilities can only be used with a suitable antenna system. For land based installations you'll need a broadband antenna. For mobile installations you'll need a Codan automatic tuning whip antenna.

It is assumed that before you use any of the procedures in this section, you have turned on the transceiver.

All displays in this section show examples of channel and frequency numbers. You must insert your selected channel and frequency numbers.



Scan mode terms

The following abbreviations are shown in the display.

- F Frequency
- L Lower side band
- LU Lower and upper side band
- U Upper side band







Setting up the scan mode





The scan program allows your transceiver to scan a selected number of frequencies. Your transceiver also has the option to run in normal or Auto-scan mode. The Auto-scan mode automatically puts the transceiver back into scan after five minutes of inactivity (such as no channel change, PTT, tune etc.). These scan facilities have two options:

- Enabled—scan programs can be entered and deleted from the front panel.
- Inhibit—scan programs cannot be entered or deleted from the front panel.

Note: The front panel link does not need to be moved for transceivers with an EPROM issue of 4.1 and above. For these models, ensure the transceiver is switched off and go to step 2.

Step	Action...	Display shows...	Remarks...
1.	Turn the transceiver off and move the front panel link to position 1.	No display.	Before moving the link, note its original position. Refer to section 11, <i>Changing the position of the front panel link.</i>
2.	Hold down  and press 	Hold down the Scan button until the display shows 	This turns the transceiver on, and into the scan set-up mode.
3.	Press 		Each press of the Scan button scrolls to the next option. If this is the option you want, go to step 7.



Step	Action...	Display shows...	Remarks...
4.	Press 		Switches to Auto option. If this is the option you want, go to step 7.
5.	Press  Pressing the Scan button again returns you to the display in step 2.		Switches from inhibit to ENABLE.
<p>Note: If you select automatic scanning, you now have the option of selecting Selective Call Mute to be enabled as soon as you enter the automatic scan mode. If you wish to select this option then continue with step 6, if not, go to step 7</p>			
6.	Press 	The display does not change.	The indicator will be lit. You have now selected selective call mute to be enabled as soon as you enter the automatic scan mode.





Step	Action...	Display shows...	Remarks...
7.	Press 	No display.	Your selection has been made and the transceiver is now switched off. This procedure is now complete for transceivers with EPROM version 4.1 and above. For earlier models, continue with step 8.
8.	Return the front panel link to its original position (F or E).		Refer to section 11, <i>Changing the position of the front panel link.</i>
9.	Replace the cover before switching on your transceiver.		Refer to section 11, <i>Changing the position of the front panel link.</i>





Programming the channels to be scanned

In normal operating conditions, a maximum of 15 channels can be programmed to be scanned in sequence for audio (voice) signals. Channels required to operate on a selective call must be programmed within the first eight entries.

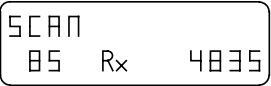
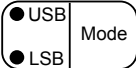
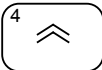
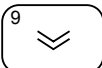
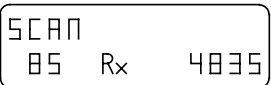
Ensure your transceiver is switched on and scan program has been enabled.

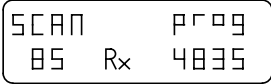

Step	Action...	Display shows...	Remarks...
1.	Press  and then  within one second.		The Scan button indicator flashes. Any previous channels programmed to be scanned will be erased.
2.	Select the required mode Press 		The appropriate mode indicator will light. You can only transmit and receive in the LSB mode if option LU is fitted.
3.	Select the relevant channel Press  or 		Refer to section 4, <i>Selecting channels</i> . Channels required to operate on selective call must be enabled. Refer to section 5, <i>Enabling a channel for selective call</i> .



Step	Action...	Display shows...	Remarks...
4.	Press 		The channel is programmed for scanning. Repeat this procedure until all channels you want to scan have been programmed.
5.	Press  and then  within one second.		The channels you have programmed are now registered within the transceiver.

Notes: If an error is made, the programming mode must be switched off (follow step 5), and the procedure repeated.

If you try to program more than 15 entries, you will hear a single low-pitched tone and the error message 'scan full' displays.

The channel entries can be reviewed while in the scan programming mode. Use the channel  and  buttons to scroll through the channels. Any channel in the scan program is indicated by 'prog' on the display (as shown in step 4 above).

The scan program can be inhibited, refer to *Setting up the scan mode* on page 6-3.



Receiving in scan mode

This procedure covers three topics when receiving in scan mode:

- start scanning
- stop scanning
- changing the scan mode.

Start scanning

Step	Action...	Display shows...	Remarks...
1.	Press 	The display shows details of each channel as it is scanned.	The Scan button indicator will be lit during scanning.

Notes: You cannot transmit while the transceiver is in the scan mode. If you attempt to transmit, you will hear a single 'pip' and the error message 'No Ptt Error' will be displayed.

If you need to transmit, you must stop the scanning operation.



Stop scanning

Step	Action...	Display shows...	Remarks...
1.	Press  or press the microphone PTT button twice in succession.	The display shows the last channel scanned.	The Scan button indicator is off.

Note: If you only press the PTT button once, the display shows 'NO PTT Error'



Changing the scan mode

There are three scan mode options available to you which can be selected by repeatedly pressing the Mute On/Off button. Your transceiver must be in the scan mode to complete this operation (refer to *Receiving in scan mode* on page 6-8).

- Pause scanning. Scanning stops for five seconds when an audio signal is detected.
- Hold scanning. Scanning stops when an audio signal is detected, and continues only when the signal ceases.
- Continuous scanning. Each channel is monitored for one second; scanning continues regardless of any audio signals being detected.

Note: scan modes operate for both voice and selective call reception

Step	Action...	Display shows...	Remarks...
1.	Ensure the transceiver is in the Scan mode.	The display shows the frequencies as they are scanned.	The Scan button indicator will be lit in the Scan mode. Refer to <i>Receiving in scan mode</i> on page 6-8.
2.	Pause scanning Press once 		You will hear a single 'pip' and the Mute On/Off indicator will be lit. If you want <i>Hold scanning</i> , go to step 3. To exit this mode go to step 5.



Step	Action...	Display shows...	Remarks...
------	-----------	------------------	------------

3. Hold scanning

Press again



You will hear two 'pips' and the Mute On/Off indicator will be lit.

If you want *Continuous scanning*, go to step 4.

To exit this mode go to step 5.

4. Continuous scanning

Press again



You will hear a single 'pip' and the Mute On/Off indicator will be off.

5. To exit this mode, press





Using selective call in scan mode

Selective call scanning ensures that you are only alerted when the incoming calls are specifically addressed to you.



This facility also allows the transceiver to store in memory the addresses of up to ten stations that may have tried to contact the transceiver whilst unattended. These addresses may have been transmitted over any of the programmed channels.

The first eight channels of the scan are used for selective call scanning.

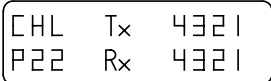
For networks using this facility, it is important for the calling station to transmit a long preamble. For more details on selective calling, refer to section 5, *Using selective call*.

Step	Action...	Display shows...	Remarks...
1.	Press 	The display shows each channel as it is scanned.	The Scan indicator will be lit.
2.	Press 		On detection of a call, scanning stops until the call is decoded. If the call is addressed to your transceiver you will hear a series of three telephone rings followed by pips every four seconds. If the call is not addressed to your transceiver, the scan continues.



Step	Action...	Display shows...	Remarks...
3.	<p>If the call is addressed to the transceiver the display changes.</p> <p>Every time an addressed call is detected, the display will repeat the same message with the appropriate channel frequency.</p>		<p>If the call is not answered immediately, the scanning stops for 2½ minutes and you will hear 'pips' every 4 seconds.</p> <p>After this period of time the transceiver carries on scanning.</p>
4.	<p>To stop scanning press</p> 		<p>The button indicator will go out.</p>



Programming frequency band scan





The band scanning facility enables the transceiver to scan between two programmed frequencies. You can program the frequency bands to suit your needs.

Up to 30 bands can be programmed into the transceiver, and stored between channels P70 and P99.

There are two rates of scan available, fast and slow:

- fast scanning changes the frequency in ten 1 kHz steps per second
- slow scanning changes the frequency in ten 100 Hz steps per second.





Your transceiver must be switched on before commencing this procedure.

Step	Action...	Display shows...	Remarks...
1.	<p>The following buttons must be pressed within one second.</p> <p>Press</p>  <p>then press any of the Tune Rx Frequency buttons, example</p>  <p>then press</p> 		<p>The Scan button indicator flashes.</p> <p>The next action must start within 60 seconds.</p>

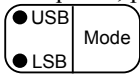

Step	Action...	Display shows...	Remarks...
2.	Using the numeric buttons, enter the start frequency to the nearest 100 Hz.		This is an example of selecting a band scan to start at 4000 kHz.
3.	Press		The decimal points are automatically entered by the transceiver.
4.	Enter the stop frequency to the nearest 100 Hz.		This is an example of selecting a band scan to stop at 5000 kHz.
5.	Press		
6.	Press		S indicates the slow rate of scan (100 Hz steps).
	or		F indicates the fast rate of scan (1 kHz steps).

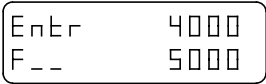
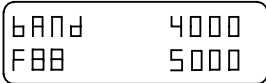

Step	Action...	Display shows...	Remarks...
7.	If a mode change is required, press 		Each press selects the next option; upper side band (U), lower side band (L), both side bands (LU) and back to (U). Note: option L is required for lower side band operation.
8.	Press 		
9.	Enter the channel number you have selected. (eg 88)	 If the display shows either prog USEd, prog inhib or prog FULL refer to the notes on the next page.	You can select a number between 70 and 99. The F is automatically entered.
10.	Press 		The Scan indicator light goes out. The frequency band has been selected. You can repeat the operation until all the channels are full.



Notes: If the display shows 'prog USEd', either enter another channel number or press the Enter button to overwrite the existing information.

If the display shows 'prog inhib', the scan facility is inhibited. Refer to section 11, *Changing the set up options*.

If the display shows 'prog FULL', all 99 user program channels are used. Either press the Enter button to overwrite the existing information, or select a channel that you no longer require and press Enter.

Further details on these three messages can be found in *Programming display messages* in section 7.



Scanning frequency bands

The band scanning facility enables the transceiver to scan between two programmed frequencies, refer to *Programming frequency band scan* on page 6-13.



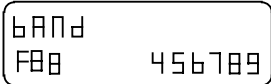

There are two rates of scan available, fast and slow:

- fast scanning changes the frequency in ten 1 kHz steps per second
- slow scanning changes the frequency in ten 100 Hz steps per second.

The following steps explain how to scan the frequency bands:







Step	Action...	Display shows...	Remarks...
1.	Select the relevant programmed band scan channel between P70 and P99.		Refer to section 4, <i>Selecting channels</i> . Band scan channels are indicated as an 'F' number.
2.	Press 	 The display shows the channel number and all the frequencies as the band is scanned continuously.	The Scan button indicator will be lit.

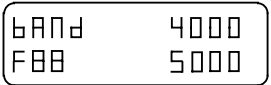

Step	Action...	Display shows...	Remarks...
3.	To pause the scan, press any of the fast or slow Tune Rx Frequency buttons. Example: 	The display shows the channel number and the current frequency.	You may move between the frequencies by using any of the Tune Rx Frequency buttons.
4.	To resume scanning, press 	The display shows the channel number and all the frequencies as the band is scanned continuously.	The rate of scan will be determined by whether you pressed the fast or slow button in step 3.
5.	To stop scanning, press 		The Scan button indicator will go out.
6.	To recommence normal scanning, select another non-band scanning channel and press 		Refer to section 4, <i>Selecting channels</i> .



Deleting unwanted scan channels

Step	Action...	Display shows...	Remarks...
1.	Select the channel you wish to delete.	 <p>An example for channel 88.</p>	Refer to section 4, <i>Selecting channels</i> .
2.	Press 		
3.	Press this button twice 		Two '0's entered as a channel number deletes the information in the selected channel.
4.	Press 	The display shows the details of the next lowest channel.	

Note: The scan program can be locked to prevent changes being made. If changes are attempted on a locked channel the display shows 'prog inhib'. If you need to amend this facility, refer to page 6-3 *Setting up the scan mode*.



Using the receiver in scan mode

7. Programming channels

Generally transceivers are supplied with an inbuilt facility (option TXD—Transmit Disabled), which prevents you from programming or changing transmit frequencies from the front panel. Under special circumstances, and where local licensing authorities permit, you may fit option TXE (Transmit Enable) which allows you to create or change the transmit frequencies of your transceiver.

Your transceiver can store up to 600 channels. A maximum of 501 transmit and receive channels can be pre-programmed by the factory or a Codan agent. The remaining 99 programmable channels (P-channels) can be set by you from the front panel.

Pre-programmed channels may be copied as P-channels and have their options modified, such as:

- E—emergency call (RFDS in Australia)
- S—selective call
- t—calls (four 2-tone calls)
- Upper Side Band mode (USB) or Lower Side Band mode (LSB—if fitted).

The factory or agent programmed channels are stored in the internal memory and can only be reprogrammed or deleted by the factory or agent. You can only create or change the transmit frequencies if your transceiver has option TXE fitted.

P-channels are stored in memory but can be reprogrammed or deleted at any time by the operator.

All displays in this section show examples of channel and frequency numbers. You must insert your selected channel and frequency numbers.

Setting up the P-channel inhibit options

The programmable channel feature (P-channel) that you program from the front panel of the transceiver, has four inhibit options. Each option places different restrictions on the operator to prevent interference to the programmed channels. The four options are:

- No inhibit (No inhib). This option allows you to overwrite or delete P-channels from the front panel.
- Standard inhibit (Std inhib). This option inhibits you from overwriting and deleting P-channels, but allows you to program new P-channels.
- Full inhibit (FULL inhib). This option prevents the Enter button from working (which inhibits all P-channel programming) and the Tune Rx Frequency buttons are disabled.
- Total inhibit (tOtAL inhib). This option is the same as Full inhibit, plus the transmit and receive frequencies are not displayed.



Apart from 'No inhibit', the remaining options require an Inhibit link fitted to the microprocessor PCB. Further details can be found in section 11, *Inserting the microprocessor link*.



This section covers two procedures:

- Checking if the inhibit link has been fitted to the PCB
- Changing the inhibit options.

Checking if the inhibit link is fitted to the PCB

In this mode, all P-channels may be overwritten or deleted from the front panel. This facility is only available when there is no Inhibit link fitted to the microprocessor PCB.

Note: The front panel link does not need to be moved for transceivers with an EPROM issue of 4.3 and above. For these models, ensure the transceiver is switched off and proceed to step 2.

Step	Action...	Display shows...	Remarks...
1.	Turn the transceiver off and move the front panel link to position 1.	No display.	Before moving the link, note its original position. Refer to section 11, <i>Changing the position of the front panel link.</i>
2.	Hold down  and press 	Hold down the Enter button until the display shows  Note: If there is an Inhibit link fitted, the display shows whichever inhibit has been selected.	This display confirms that no Inhibit link is fitted to your transceiver. The message means that there are no inhibits on P-channel programming.





Step	Action...	Display shows...	Remarks...
3.	Press 	No display.	The transceiver is now switched off. This procedure is now complete for transceivers with EPROM version 4.3 and above. For earlier models, continue with step 4.
4.	Return the front panel link to its original position (F or E).		Refer to section 11, <i>Changing the position of the front panel link.</i>
5.	Replace the cover before switching on your transceiver.		Refer to section 11, <i>Changing the position of the front panel link.</i>







Changing the inhibit options

Only qualified technicians should complete this procedure. This mode can only be entered if the Inhibit link is fitted across pad 2 on the microprocessor PCB and the front panel link is repositioned. Refer to section 11, *Inserting the microprocessor link* and *Changing the position of the front panel link*.

Step	Action...	Display shows...	Remarks...
1.	Turn the transceiver off and move the front panel link to position 1.	No display.	Before moving the link, note its original position. Refer to section 11, <i>Changing the position of the front panel link</i> .
2.	Insert an Inhibit link across pads 2 on the microprocessor PCB.		Refer to section 11, <i>Inserting the microprocessor PCB link</i> .
3.	Hold down  and press 	Hold the Enter button down until the display shows 	This display shows your last setting, either Std, FULL or tOTAL inhib. Pressing the Enter button scrolls through the available options. If this is the option you want, go to step 6.

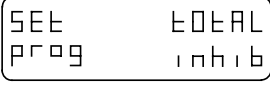





Step	Action...	Display shows...	Remarks...
4.	Press 		Pressing the Enter button scrolls through the available options. If this is the option you want, go to step 6.
5.	Press 		If this is the option you want, go to step 6.
6.	Press 	No display.	The transceiver is now switched off.
7.	Remove the inhibit link you inserted across pads 2 on the microprocessor PCB.		Refer to section 11, <i>Inserting the microprocessor link.</i>
8.	Return the front panel link to its original position (F or E).		Refer to section 11, <i>Changing the position of the front panel link.</i>
9.	Replace the cover before switching on your transceiver.		





Copying channels to P-channels

This facility allows you to copy the factory or agent pre-programmed channels already stored in memory and make them P-channels. This allows you to group the most commonly used channels which can save you time searching for them in the main program.

Ensure your transceiver is switched on before commencing this procedure.

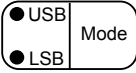
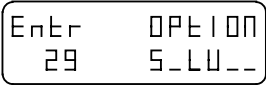
Step	Action...	Display shows...	Remarks...						
1.	Use the Recall or Channel  and  buttons to find the channel you want to copy.	<div style="border: 1px solid black; padding: 5px; display: inline-block;"> <table style="border-collapse: collapse; width: 100%;"> <tr> <td style="padding: 2px 10px;">CHL</td> <td style="padding: 2px 10px;">Tx</td> <td style="padding: 2px 10px;">4321</td> </tr> <tr> <td style="padding: 2px 10px;">29</td> <td style="padding: 2px 10px;">Rx</td> <td style="padding: 2px 10px;">4321</td> </tr> </table> </div> <p>An example for channel 29.</p>	CHL	Tx	4321	29	Rx	4321	Refer to section 4, <i>Selecting channels</i> .
CHL	Tx	4321							
29	Rx	4321							
2.	Press 	<div style="border: 1px solid black; padding: 5px; display: inline-block;"> <table style="border-collapse: collapse; width: 100%;"> <tr> <td style="padding: 2px 10px;">Enter</td> <td style="padding: 2px 10px;">Tx</td> <td style="padding: 2px 10px;">-----</td> </tr> <tr> <td style="padding: 2px 10px;">29</td> <td style="padding: 2px 10px;">Rx</td> <td style="padding: 2px 10px;">4321</td> </tr> </table> </div>	Enter	Tx	-----	29	Rx	4321	Your next action must start within 60 seconds.
Enter	Tx	-----							
29	Rx	4321							
3.	Press 	<div style="border: 1px solid black; padding: 5px; display: inline-block;"> <table style="border-collapse: collapse; width: 100%;"> <tr> <td style="padding: 2px 10px;">Enter</td> <td style="padding: 2px 10px;">OPT 00</td> </tr> <tr> <td style="padding: 2px 10px;">29</td> <td style="padding: 2px 10px;">---U---</td> </tr> </table> </div>	Enter	OPT 00	29	---U---	This allows you to select options.		
Enter	OPT 00								
29	---U---								
4.	Repeatedly press  to select either option S/t1/t2/t3 or t4.	<div style="border: 1px solid black; padding: 5px; display: inline-block;"> <table style="border-collapse: collapse; width: 100%;"> <tr> <td style="padding: 2px 10px;">Enter</td> <td style="padding: 2px 10px;">OPT 00</td> </tr> <tr> <td style="padding: 2px 10px;">29</td> <td style="padding: 2px 10px;">S---U---</td> </tr> </table> </div>	Enter	OPT 00	29	S---U---	<p>Stop when you reach the option you require.</p> <p>Refer to section 4, <i>Option codes</i>.</p> <p>Note: You cannot select both tone call and emergency call.</p>		
Enter	OPT 00								
29	S---U---								

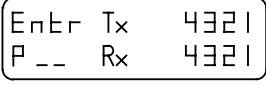

Step	Action...	Display shows...	Remarks...
5.	Press 		Each press of the Mode button presents the next sideband option. Stop when you reach the option you require. Refer to section 4, <i>Option codes</i> .
6.	Press 		Repeatedly pressing the Emergency Call button switches this option on and off. Note: You cannot select both emergency call and tone call.
7.	Press 		This registers the options you selected and allows you to enter a channel number. The 'P' is automatically entered.

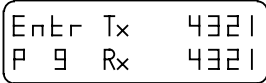

Step	Action...	Display shows...	Remarks...
8.	Use the numeric buttons to enter your choice of channel number between 1 and 99.		<p>This is an example for channel P9.</p> <p>If the display shows either FULL, USED or inhib, refer to page 7-16, <i>Programming display messages</i>.</p>

Note: Channels using different transmit and receive frequencies (2-frequency simplex channels) must be copied to channels P70 to P99.

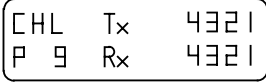



9.	Press 		This registers the new channel in your transceiver.
----	--	---	---





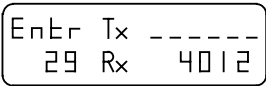

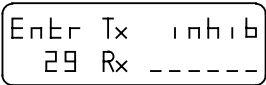
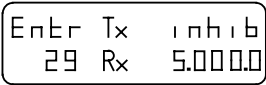
Creating receive only P-channels

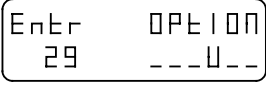
All transceivers have the facility to create or change the receive P-channels from the front panel.

Ensure your transceiver is switched on before commencing this procedure.

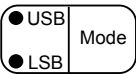
Step	Action...	Display shows...	Remarks...
1.	Press 		Your next action must start within 60 seconds.
2.	Press 		
3.	Use the numeric buttons to enter the receive frequency.	 If the display shows either a 'too hi' or 'too lo' error message, refer to <i>Programming display messages</i> on page 7-16.	The frequency must be entered to the nearest 100 Hz, between 250 kHz and 30 MHz. The display shows an example of 5 MHz.
4.	Press 		This facility defaults to the last channel setting.

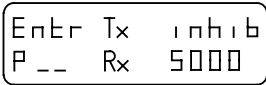
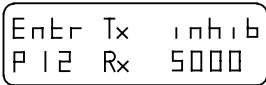

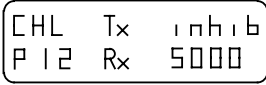
Step	Action...	Display shows...	Remarks...
5.	Press 		Each press of the Mode button presents the next sideband option. Stop when you reach the option you require. Refer to section 4, <i>Option codes</i> .
6.	Press 		This registers the options you selected and allows you to enter a channel number. The 'P' is automatically entered.
7.	Use the numeric buttons to enter your choice of channel number between 1 and 99.		This is an example for channel P12. If the display shows either FULL , USED or inhib , refer to page 7-16, <i>Programming display messages</i> .
8.	Press 		This registers the new channel in your transceiver. You can now continue with normal transceiver operations.





Creating transmit and receive P-channels

All transceivers have the facility to create or change the receive P-channels from the front panel.



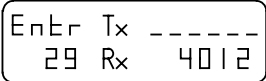
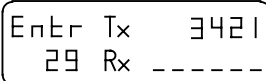

You can only create, or change, transmit P-channels from the front panel of your transceiver if it has option TXE fitted. Under special circumstances, and where local licensing authorities permit, option TXE (transmit enable) may be fitted to your transceiver. This option must be requested at the time of purchase.

Only under these conditions will the following apply.

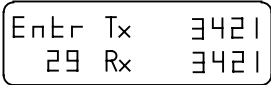

Ensure your transceiver is switched on before commencing this procedure.

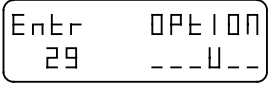
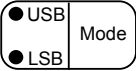
Step	Action...	Display shows...	Remarks...
1.	Press 		Your next action must start within 60 seconds.
2.	Use the numeric buttons to enter the transmit frequency.		This example is for transmit frequency 3421. The frequency must be entered to the nearest 100 Hz, between 250 kHz and 30 MHz.
3.	Press 		

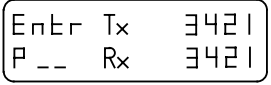



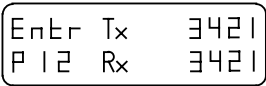

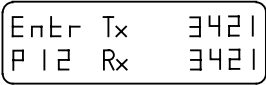





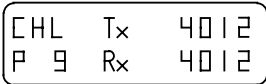

Step	Action...	Display shows...	Remarks...
4.	<p>Use the numeric buttons to enter the receive frequency.</p> <p>Or push  again if the receive is the same frequency as transmit.</p>	 <p>If the display shows either a 'too hi' or 'too lo' error message, refer to <i>Programming display messages</i>, page 7-16.</p>	<p>This example is for receive frequency 3421.</p> <p>The frequency must be entered to the nearest 100 Hz, between 250 kHz and 30 MHz.</p>
5.	<p>Press </p>		<p>This facility defaults to the last channel setting.</p>
6.	<p>Press </p>		<p>Each press of the Mode button presents the next sideband option. Stop when you reach the option you require.</p> <p>Refer to section 4, <i>Option codes</i>.</p>
7.	<p>Press </p>		<p>This registers the options you selected and allows you to enter a channel number.</p> <p>The 'P' is automatically entered.</p>

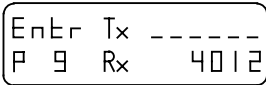

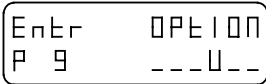
Step	Action...	Display shows...	Remarks...
8.	Use the numeric buttons to enter your choice of channel number between 1 and 99.		<p>This is an example for channel P12.</p> <p>If the display shows either FULL, USEd or inhib, refer to page 7-16, <i>Programming display messages</i>.</p>
9.	Press 		<p>This registers the new channel in your transceiver.</p> <p>You can now continue with normal transceiver operations.</p>

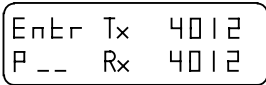

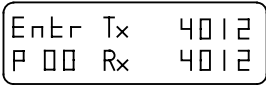
Deleting unwanted P-channels

Step	Action...	Display shows...	Remarks...
1.	Use the Recall or Channel  and  buttons to find the channel you want to delete.	 <p>An example for channel P9.</p>	Refer to section 4, <i>Selecting channels</i> .
2.	Press 		Your next action must start within 60 seconds.
3.	Press 		You need to press enter to scroll through the options.
4.	Press 		
5.	Press this button twice 		Two zeros entered as a channel number will cause the transceiver to erase the information in that channel.
6.	Press 	The transmit and receive frequencies of the next lowest channel.	If the display shows inhib , refer to page 7-16, <i>Programming display messages</i> .



Programming display messages

Whilst programming channels, the display may present you with the following messages:

- inhibit (**inhib**)
- used (**USEd**)
- full (**FULL**)
- too hi or too low (**too hi** or **too lo**).

Inhibit (**inhib**)

P-channels can be protected from being accidentally deleted or overwritten by soldering a link on the microprocessor PCB. (Refer to section 11, *Inserting the microprocessor PCB link*.)

If you try to delete or overwrite a channel with the link installed, the display shows **inhib** when you press the Enter button. You must try another channel number in order to store your selection.

Used (**USEd**)

If the display shows **USEd**, the channel number you selected is already being used and the overwrite protection link is not installed (refer to Inhibit, above). Either enter another channel number or overwrite the existing channel number by pressing the Enter button again.



If the overwrite protection link is not installed, pressing the Enter button again will erase the frequency previously allocated to this channel number.

Full (FULL)

If the display shows **FULL**, all 99 P-channels have been used.



If the overwrite protection link is not installed, pressing the Enter button again will erase the frequency previously allocated to this channel number.

Select a channel number you no longer need, and overwrite that number by pressing the Enter button again.

If the overwrite protection link is installed, it will have to be removed before you can save your new channel selection. (Refer to section 11, *Inserting the microprocessor PCB link.*)

Too high or too low (too hi or too lo)

If you try to program a frequency outside the range of 250 kHz to 30 MHz, the transceiver shows an error message **too hi** or **too lo**. To overcome this problem, you must reprogram another frequency within the transceivers range.



Setting up temporary channels

During any channel programming operations, copying or creating a P-channel, you can press the Enter button instead of entering a channel number. This creates a temporary channel which will not be saved when you switch off the transceiver.



8. Using tone call

The tone call facility provides stations within a network to either call (tone encode–TE), or be called (tone decode–TD) by other stations, using the transmission of tones

Tone calls use two tones (High and Low) transmitted simultaneously to call another station. The tones used must be identical for both the transmitting and receiving transceivers.

The tones fit into two frequency bands, each with a High and Low tone, either 440 Hz or 360 Hz apart. Each of these bands must lie within the frequency range 850 Hz and 1500 Hz.

In Australia, the RFDS uses the 440 Hz frequency band, an example for this type of call would be 880 Hz and 1320 Hz. Private communications in Australia use the 360 Hz frequency band, a typical example for this type of call would be 880 Hz and 1240 Hz.

To receive a tone call your transceiver must have option TD fitted. To transmit a tone call, tone call must be enabled on the selected channel.











You cannot have the automatic tuning antenna (option AD) and 2-tone decoder (option TD) fitted to the same transceiver. Also, selective call and tone call cannot be enabled on the same channel.

Tones t1 and t2 are given values in the factory. You can override these settings by using the following *Set-up* procedure. To reinstate the original values, either enter '0' frequency or delete the latest channel information.



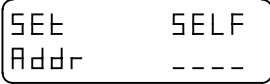

All displays in this section show examples of channel and frequency numbers. You must insert your selected channel and frequency numbers.

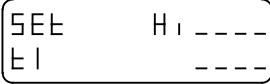
Setting up tone call

This procedure is similar to setting up selective call. Once in the set-up mode, you can skip through the non-important steps by pressing the Enter button.

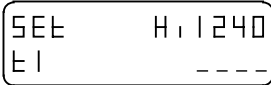
Step	Action...	Display shows...	Remarks...
1.	To start the set-up mode, hold down  and press 		Hold the Call button down for approximately three seconds. This turns the transceiver on, and into the preamble set-up mode.
2.	Press 		This set-up is not required.
3.	Press 		This set-up is not required.
4.	Press 		This set-up is not required.
5.	Press 		This part of the procedure allows you to enter the tone calling frequencies.

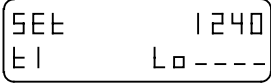

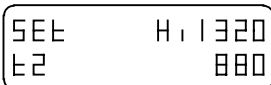
Step	Action...	Display shows...	Remarks...
6.	Use the numeric buttons to enter the t1 Hi tone frequency. Entering a new number overrides an existing frequency.	 If you enter an incorrect frequency, the display shows an error. For further details, refer to section 12, <i>Display messages</i> .	There are four pairs of tone frequencies that you can set, t1, t2, t3 and t4. The t1 & t2 frequencies are pre-set in the factory. If you wish, you may alter settings. Each tone setting has a high and low frequency.
7.	Press  You must complete the next step within 60 seconds.		This sets the new t1 Hi tone frequency and allows you to set the t1 Low tone frequency.
8.	Use the numeric buttons to enter the t1 Low tone frequency.		Entering a new number overrides an existing frequency.
9.	Press  You must complete the next step within 60 seconds.		This sets the new t1 Low tone frequency and allows you to set the next tone pair t2.



Step	Action...	Display shows...	Remarks...
------	-----------	------------------	------------

10.	Steps 6 to 9 are repeated by the transceiver for t2, t3 and t4.
-----	---

The display shows the same as in steps 6 to 9, except for the tone and frequency numbers.

When all four tone pairs are recorded, the display returns to the first set-up option

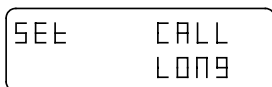

11.	Press
-----	-------



This turns your transceiver off and registers all the tone call settings you have just made.
--







Enabling a channel for tone calling

This procedure explains how to enable a channel for tone calling. Initially, you need to select a channel frequency you want to enable, and then choose a tone call pair for that frequency.





You can copy this information into the P-channel program.

This procedure is similar to *Enabling a channel for selective call* in section 5. Once in the set-up mode, you can skip through the non-important steps by pressing the Enter button.

The displays in this section will vary depending on the channel you select (ie the word inhibit may be replaced with a frequency number).

Step	Action...	Display shows...	Remarks...
1.	Use the Recall or Channel  and  buttons to find the channel you wish to enable.	<div style="border: 1px solid black; padding: 5px; display: inline-block;"> CHL Tx 4321 29 Rx 4321 </div> An example for channel 29.	Refer to section 4, <i>Selecting channels</i> .
2.	Press 	<div style="border: 1px solid black; padding: 5px; display: inline-block;"> Enter Tx ----- 29 Rx 4321 </div>	You will hear a 'pip'.
3.	Press 	<div style="border: 1px solid black; padding: 5px; display: inline-block;"> Enter Tx 4321 29 Rx ----- </div>	You will hear a 'pip'.
4.	Press 	<div style="border: 1px solid black; padding: 5px; display: inline-block;"> Enter OPTION 29 ----U-- </div>	You will hear a 'pip'.

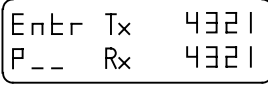
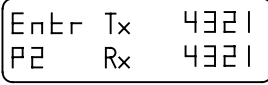

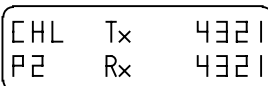
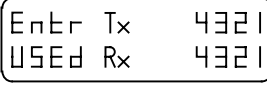
Step	Action...	Display shows...	Remarks...
4.	Press  Repeat this action until a 't' and the required tone pair appear in the left hand two spaces of the options bar.	 An example for tone pair t3.	You will hear a 'pip'.
5.	Press 		You will hear a 'pip'.
6.	Use the numeric buttons to enter the channel number you wish to use.		You will notice that the display automatically inserts a 'P' to the number.
7.	Press 	 If the channel is already used the display shows 	







Step	Action...	Display shows...	Remarks...
8.	If the channel is already used, you can either enter another number or press Enter again to override the existing one.	The display reverts back to normal.	The information will either be stored under an existing channel number, or you will have created a new one.

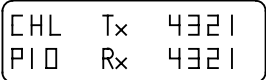
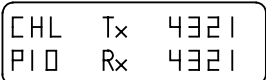

Using the tone call mode

Before commencing this procedure, ensure the Mute On/Off button is in the off position (indicator off) and the antenna is tuned to the selected frequency. This section covers both transmitting and receiving a tone call.

Transmitting a tone call

Step	Action...	Display shows...	Remarks...
1.	Use the channel buttons or Recall button to select the channel you wish to use.		Ensure the channel you select is enabled for tone call. To check, press the Display button.
2.	Ensure that the channel is free from traffic.		Listen for approximately 10 seconds.
3.	Press and hold  for approximately 10 seconds. If the channel you selected was not enabled, an error message will be displayed.	The display does not change. 	You will hear a tone and the Tx indicator will be lit. You will hear a low pitched tone. The call will not be transmitted, and you must choose another channel.
4.	You can start communication when contact has been established.		

Receiving a tone call

To receive a tone call your transceiver must be fitted with option TD.

Step	Action...	Display shows...	Remarks...
1.	No action. Upon receipt of a tone call, your transceiver displays the channel number of the calling station.		<p>You will hear an alarm consisting of two sets of three short 'pips'. Following this alarm you will hear a 'pip' every four seconds.</p> <p>You can cancel the 'pips' by pressing the microphone PTT button.</p>
2.	Use the microphone in the normal manner to reply to the call.		



Using tone call



9. Making a telephone interconnect call

If the base station transceiver is linked to an IPC-500 telephone interconnect unit (figure 9.1), it can make and receive telephone calls through the public switched telephone network (PSTN).

Using the selective call facility on your outstation transceiver to signal the base station telephone interconnect, you can dial any telephone number of up to 16 digits. The number is sent as part of the selective call signal.

Your outstation transceiver can store up to 10 pre-programmed telephone numbers which can be recalled for 'abbreviated dialling'. In addition, your outstation transceiver can receive a selective call containing a telephone number which can be stored and reviewed later.

When the telephone mode is enabled, P-channels P90 to P99 are used for storage of telephone numbers with the base station telephone interconnect facility. These channels are no longer available for general use with channel frequencies.

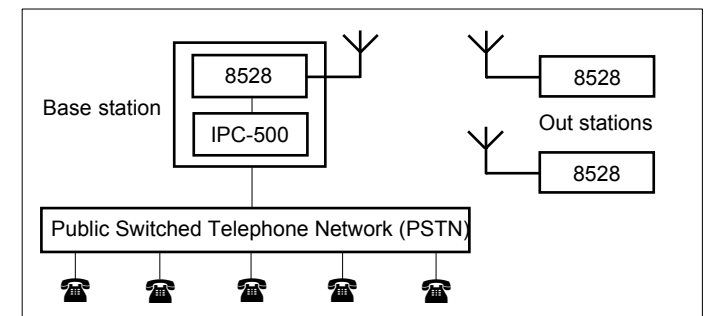
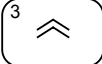

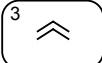
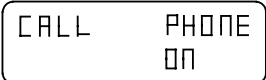



Figure 9.1: Telephone interconnect block diagram

Enabling the telephone mode

You can only make telephone calls from your outstation transceiver if the telephone mode is enabled. You can still use all the transceiver's other functions while this mode is enabled.

To complete this procedure on transceivers with program (EPROM) issue numbers of 4.1 and higher, follow the steps below. If prior to 4.1, the front panel link will have to be moved before commencing this procedure. To check the issue number, refer to the *Review the EPROM version and options* procedure in section 4. To move the front panel link, refer to *Changing the position of the front panel link* procedure in section 11.

Step	Action...	Display shows...	Remarks...
1.	To enter the phone mode, hold down  and press 	Hold down the number 3 button until the display shows 	This turns the transceiver on and into the phone set-up mode.
2.	Press  to switch between ON and OFF.		Continually pressing the number 3 button switches the telephone mode on and off.
3.	Switch the transceiver off at your desired setting, or press 		This sets the telephone mode you require.



Making a telephone call

This procedure explains how to make a telephone call from your outstation transceiver to the base station transceiver IPC-500 system.





Ensure your transceiver is switched on before commencing this operation.

Ensure the antenna is tuned on the selected channel, refer to *Tuning the antenna* in section 4.



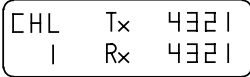

Notes: Before making a telephone call, it is often beneficial to make a beacon call to assess the best channel to use. Refer to *Using the beacon feature* in section 5.)

If you enter a wrong number, you can reset by pressing the 'Display' button.

When you have finished making a call, you must disconnect the call line. (Refer to *Sending a disconnect message* on page 9-6.)

Step	Action...	Display shows...	Remarks...
1.	Use the Channel buttons or Recall button to select the channel you wish to use.	 <p>This is an example for channel 1.</p>	Refer to section 4, <i>Selecting channels</i> . Ensure the channel is enabled for selective call.
2.	Press 		You must start the next action within 60 seconds.
3.	Use the numeric buttons to enter the required selective call address.		This is the self identification number of the base IPC-500 telephone interconnect you are using. Refer to section 5, <i>Using selective call</i> .

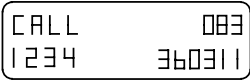

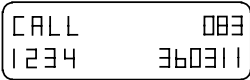
Step	Action...	Display shows...	Remarks...
4.	Press 		
5.	Use the numeric buttons to enter the telephone number you wish to call.		This example number is 08 336 0311. (Numbers wrap around in the display from the bottom to the top row, including the CALL area—16 digits.)
6.	Check the channel is free from traffic, then press 		<p>The Tx indicator lights and you will hear a warbling sound for approximately 10 seconds as the transceiver sends your call.</p> <p>If the call is received successfully by the IPC-500 you will here a revertive tone, then there will be a pause while the number is being dialled. Once the number has been dialled by the IPC-500, you will hear the appropriate telephone network service tones.</p>

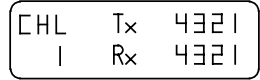

Step	Action...	Display shows...	Remarks...
7.	<p>When the telephone subscriber answers, they will hear a short pre-recorded message informing them that this is a radio telephone call.</p> <p>This is followed by a single tone of one second duration heard by both parties.</p> <p>You may now use the transceiver in the normal communication mode.</p>		<p>The indicator light flickers whilst talking.</p> <p>On completing the call, you must send a disconnect message (refer to <i>Sending a disconnect message</i> on page 9-6).</p> <p>You may now resume normal transceiver operation.</p>







Note: The telephone number is erased from memory once power has been turned off.

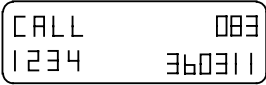

Sending a disconnect message

When a telephone call is made, a circuit is automatically established between your outstation transceiver and the telephone party that the base IPC-500 has dialed. When you finish a call, this call line must be disconnected. This is achieved by sending a disconnect message from your transceiver to the IPC-500.

This procedure assumes that the transceiver is switched on and still on the original channel, and the telephone conversation has been completed.

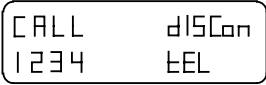
Step	Action...	Display shows...	Remarks...
1.	Press 		This is an example for the last called number 1234 on channel 1.
2.	Press 		The last telephone number you called was 08 336 0311.
3.	Press 		This deletes the last number.
4.	Press 		You are now ready to send the disconnect message.



Step	Action...	Display shows...	Remarks...
5.	Press 	The display does not change.	<p>The Tx indicator lights and you will hear a warbling sound for approximately 10 seconds as the transceiver sends your call.</p> <p>When you hear five long beeps you know that the circuit has been disconnected.</p> <p>Your transceiver is now ready for normal operation.</p>





Note: An alternative method of disconnect can be used by asking the telephone party to press '99' within two seconds on the DTMF telephone keypad.



Storing a telephone number

This facility allows you to store up to 10 telephone numbers into your transceiver, which can be re-called by entering a single code number (0 to 9) rather than a complete telephone number.

Ensure your transceiver is switched on and a selective call enabled channel has been selected before commencing this procedure. If you make an error and wish to re-start this procedure (such as entering an incorrect number), just press the 'Display' button.

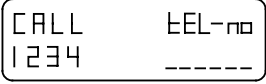
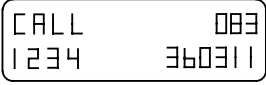
Step	Action...	Display shows...	Remarks...
1.	Press 		You must start the next action within 60 seconds.
2.	Use the numeric buttons to enter the required selective call address.		This is the self identification number of the base IPC-500 telephone interconnect you are using. See section 5, <i>Using selective call</i> .
3.	Press 		
4.	Use the numeric buttons to enter the telephone number you wish to store.		This example number is 08 336 0311. (Numbers wrap around in the display from the bottom to the top row, including the call area.)



Step	Action...	Display shows...	Remarks...
------	-----------	------------------	------------

5. Press   You can store this telephone number as a single code number, t0 to t9.

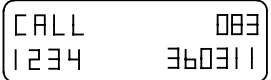
6. Use the numeric buttons to enter the code number you want, 0 to 9.  Your selection has now been made.

If the number you enter has already been used, the display will show USED and you will have to select another number.

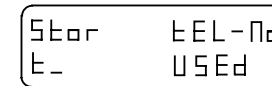









7. Continually press the  button until the display shows the original channel settings. Your transceiver is ready for normal operation.



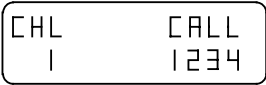

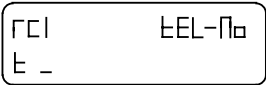
Reviewing the stored telephone numbers

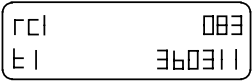
This facility allows you to review all the numbers you have stored.

Ensure your transceiver is switched on and a selective call enabled channel has been selected before commencing this operation.

Step	Action...	Display shows...	Remarks...
1.	Press 		You must start the next action within 60 seconds.
2.	Use the numeric buttons to enter the required selective call address.		This is the self identification number of the base IPC-500 telephone interconnect you are using. Refer to section 5, <i>Using selective call</i> .
3.	Press 		
4.	Press 		The display shows you the number first stored, in this example the number is 08 336 0311.
			If there are no numbers stored, the display will show

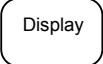

Step	Action...	Display shows...	Remarks...
5.	Keep pressing the  button to scroll through all the stored numbers.	 	This example is for number 02 971 2233. If you don't press Recall again, after one second the display changes to give you the option to call this number. Refer to page 9-12, <i>Calling a stored telephone number</i> .
6.	Continually press the  button until the display shows the original channel settings.		Your transceiver is ready for normal operation.



Calling a stored telephone number

This procedure explains how to make a telephone call to a number you have previously stored.



Ensure your outstation transceiver is switched on and a selective call enabled channel has been selected before commencing this operation.

Ensure the antenna is tuned on the selected channel, refer to *Tuning the antenna* in section 4.

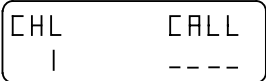
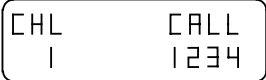

Notes: Before making a telephone call, it is often beneficial to make a beacon call to assess the best channel to use. (Refer to *Using the beacon feature* in section 5.)

If you enter a wrong number, you can reset by pressing the 'Display' button.

When you have finished making a call, you must disconnect the call line. (Refer to *Sending a disconnect message* on page 9-6.)

Step	Action...	Display shows...	Remarks...
1.	Press 		You must start the next action within 60 seconds.
2.	Use the numeric buttons to enter the required selective call address.		This is the self identification number of the base IPC-500 telephone interconnect you are using. Refer to section 5, <i>Using selective call</i> .
3.	Press 		

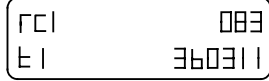
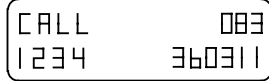

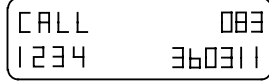
Step	Action...	Display shows...	Remarks...
4.	Use the numeric buttons to enter the number you require between 0 and 9.	 <p>After one second the display changes to</p> 	This example shows the recall number t1, and the telephone number to call as 08 336 0311.
5.	<p>Check that the channel is free from traffic, then press</p> 		<p>The Tx indicator lights and you will hear a warbling sound for approximately 10 seconds as the transceiver sends your call.</p> <p>If the call is received successfully by the IPC-500, you will here a revertive tone then there will be a pause while the number is being dialled. Once the number has been dialled by the IPC-500, you will hear the appropriate telephone network service tones.</p>



Step	Action...	Display shows...	Remarks...						
6.	<p>When the telephone subscriber answers, they will hear a short pre-recorded message informing them that this is a radio telephone call.</p> <p>This is followed by a single tone of one second duration heard by both parties.</p> <p>You may now use the transceiver in the normal communication mode.</p>	<table border="1"><tr><td>CHL</td><td>Tx</td><td>4321</td></tr><tr><td>I</td><td>Rx</td><td>4321</td></tr></table>	CHL	Tx	4321	I	Rx	4321	<p>The indicator light flickers whilst talking.</p> <p>On completing the call, you must send a disconnect message (refer to <i>Sending a disconnect message</i> on page 9-6).</p> <p>You may now resume normal transceiver operation.</p>
CHL	Tx	4321							
I	Rx	4321							





Deleting a stored telephone number

This facility allows you to delete a stored telephone number. Ensure your transceiver is switched on and a selective call enabled channel has been selected before commencing this operation.

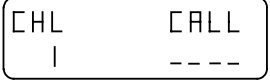

As soon as you enter the number to be deleted, it is deleted immediately from memory without any warning. To prevent deleting numbers you need, ensure you make the correct choice first time, you do not get a second chance.

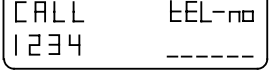
Step	Action...	Display shows...	Remarks...
1.	Press 		You must start the next action within 60 seconds.
2.	Use the numeric buttons to enter the required selective call address.		This is the self identification number of the base IPC-500 telephone interconnect you are using. Refer to section 5, <i>Using selective call</i> .
3.	Press 		If a telephone number appears in this display, press the 'Display' button to clear this number. (This will have been the last number called.)



Step	Action...	Display shows...	Remarks...
------	-----------	------------------	------------

4.

Press

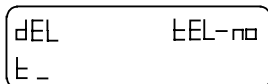

5.

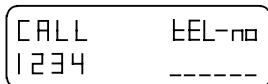

See page 9-15.

Use the numeric buttons to enter the stored number you want to delete, 0 to 9.

6.

Continually press



until the display shows the original channel settings.

Your transceiver is ready for normal operation.



Received call messages

When a call has been received and decoded, the display provides you with different messages to indicate the type of call received. The following examples show you the type of messages that will appear on the display.

This display...

```

CHL          428
P2          CALLED
    
```

Means...

An ordinary (not telephone) selective call has been received from station 428 on channel P2.

```

CHL          428
P2          T-CALL
    
```

A telephone call from station 428 containing telephone number information has been received on channel P2.

```

CALd Tx     4012
400 Rx     4012
    
```

A call has been received on another channel. This example shows a call whilst the transceiver is on channel 400 and the channel frequencies.

```

CHL          CALLED
P2          Rx 1234.0
    
```

An ARQ call has been received on channel P2.



Reviewing the list of received calls in memory

Your transceiver is able to record up to 10 calls in memory from various stations. These may be on different channels if your transceiver is in scan mode. These calls are recorded in a memory stack awaiting your review. If a station calls more than once on the same channel, your transceiver only records one of the calls. If more than 10 calls are made to your transceiver, the first call stored in memory is deleted to make room for the latest call.

Ensure your transceiver is not in the scan mode before commencing this procedure.





A permanent or brief loss of power to your transceiver will delete information stored in memory . Ensure you record or use all the information stored in the memory stack before switching off the transceiver.

Notes: If the transceiver power is lost momentarily (such as during starting the vehicle engine), the call memory is retained but the telephone number is lost.

Switching the transceiver off using the Power On/Off button deletes all calls stored in the memory stack.

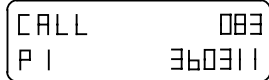
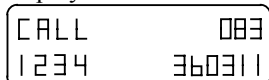
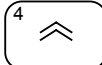
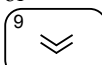

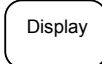
Step	Action...	Display shows...	Remarks...
1.	Press  twice within one second.	If any calls have been recorded, the display shows  and after one second the display shows  If no calls have been received, the normal channel display will remain.	The first call recorded will be displayed first. In this example, a call was received on channel P1 from telephone number 08 336 0311. The display now shows you the self identification address, 1234, of the station that called.
2.	Press either  or 	The display shows the next call, and after one second the self identification address of the caller.	Pressing either the channel  or  button scrolls you through the list of received calls recorded in the memory.
3.	Press  to return to normal operation.		To reply to any of these calls, refer to <i>Returning a call</i> on page 9-20.



Returning a call

This procedure explains how to return a telephone call to one of the numbers recorded in the memory stack.

Ensure your transceiver is switched on before commencing this operation.

Ensure the antenna is tuned on the selected channel, refer to *Tuning the antenna* in section 4.



A permanent or brief loss of power to your transceiver will delete information stored in the memory stack. Ensure you record or use all the information stored in the memory stack before switching off the transceiver.

Notes: If the transceiver power is lost momentarily (such as during starting the vehicle engine), the call memory is retained but the telephone number is lost.



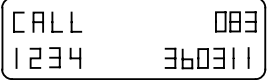

Switching the transceiver off using the Power On/Off button deletes all calls stored in the memory bank.

Before making a telephone call, it is often beneficial to make a beacon call to assess the best channel to use. (Refer to *Using the beacon feature* in section 5.)

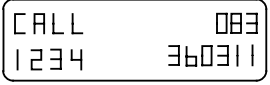

When you have finished returning calls, you must disconnect the telephone line. (Refer to *Sending a disconnect message* on page 9-6).

Step	Action...	Display shows...	Remarks...
1.	Select the call you wish to make (see <i>Reviewing the list of received calls in memory</i> on page 9-18, steps 1 & 2).		This display example shows the phone number 08 336 0311 and the self identification address 1234 of the caller.



Step	Action...	Display shows...	Remarks...
2.	Press 		The transceiver automatically selects the correct channel, and displays the self identification address (1234) of the caller.
3.	Press 		
4.	Check that the channel is free from traffic, then press 	The display does not change.	The Tx indicator lights and you will hear a warbling sound for approximately 10 seconds as the transceiver sends your call. If the call is received successfully by the IPC-500 you will here a revertive tone, then there will be a pause while the number is being dialled. Once the number has been dialled by the IPC-500, you will hear the appropriate telephone network service tones.

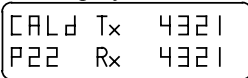

Step	Action...	Display shows...	Remarks...
5.	<p>When the telephone subscriber answers, they will hear a short pre-recorded message informing them that this is a radio telephone call.</p> <p>This is followed by a single tone of one second duration heard by both parties.</p> <p>You may now use the transceiver in the normal communication mode.</p>	<p>The display shows</p>  <p>for any call that has not been returned.</p>	<p>The indicator light flickers whilst talking.</p> <p>The viewed call is deleted from the memory stack when you press the PTT button on the microphone.</p> <p>On completing the call, you must send a disconnect message (refer to <i>Sending a disconnect message</i> on page 9-6).</p>
6.	<p>Repeat steps 1 to 5 to clear all calls stored in the memory stack.</p>		
7.	<p>Press</p>  <p>to return the transceiver to normal operation.</p>		





10. Operating with ARQ-FEC data

Your transceiver can operate with teletype ARQ-FEC data. With your transceiver connected to a Codan HF data modem, it forms an HF SSB data transmission set for remote data transmission and reception. Further detail on this facility can be found in the Codan HF data modem handbook supplied.

Terms	Description
--------------	--------------------

ARQ	Automatic Repeat Request The receiving station commands the transmitting station when to transmit and repeat a packet of data. (This is known as hand shaking.)
FEC	Forward Error Correction Once the data link is established, the transmitting station transmits all the data. Any data error correction is carried out by the receiving computer.

To operate in the teletype ARQ-FEC mode, your transceiver must have the following options installed.

Option...	Is used to...
------------------	----------------------

F	provide extra cooling to the heat sink fins to allow the transceiver to transmit data.
PS	provides modem interconnect facility.





11. Changing the set-up options

Some of the set-up options in this section can be completed by the user, others must only be carried out by qualified personnel, either at the Codan factory or by a Codan agent. A statement is made in the procedure whenever qualified personnel are required.

All displays in this section show examples of channel and frequency numbers. You must insert your selected channel and frequency numbers.

Set-up option links

Some of the set-up procedures may need a link to be moved inside the transceiver, while some need a link soldered inside the transceiver. The moveable link is called the front panel link (refer to figure 11.1), the soldered link is called the microprocessor link (refer to figure 11.2).

To complete set-up procedures on transceivers with program (EPROM) issue numbers prior to 4.1, the front panel link will have to be moved. To check the issue number, refer to the *Review the EPROM version and options* procedure in section 4.



The front panel link

The front panel link is located on the front panel display printed circuit board (PCB) assembly.

On front panel control transceivers, the PCB (part number 08-03745-001) is located behind the numeric buttons and display. The link is located on a row of four horizontally mounted pins on the PCB (figure 11.1), immediately behind the number 9 button.

On extended control transceivers, the PCB (part number 08-04666-001) is located inside the control head. The link is located on a row of four vertically mounted pins on the PCB (figure 11.1), immediately behind the number 7 button.

The front panel link can fit into four positions on the PCB, only three of which are used:

- 2** not used
- 1** used for set-up options
- F** used for front panel control transceivers
- E** used for extended control head transceivers.

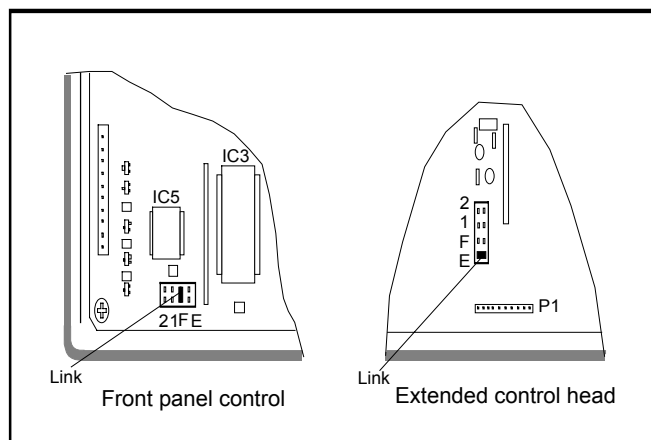

Figure 11.1: The front panel link

Changing the position of the front panel link

The front panel link is a black plastic moulding incorporating linked metal contacts. The contacts short together pins located on the front panel display PCB.



Extreme care should be taken when handling the transceiver to prevent damage to the components.

Step	Action
1.	Turn the transceiver off and disconnect the power.
2.	Remove either: <ul style="list-style-type: none">• the bottom cover of front panel control transceivers• the control head rear panel of extended control head transceivers.
3.	Make a note of the position you found the link (E or F). Move the front panel link from position F (front panel control) or E (extended control head) to position 1.
4.	You can now carry out the relevant set-up procedures.
5.	After completing the set-up procedures, turn the transceiver off and disconnect the power before returning the link to its original position.
6.	Replace the cover before reconnecting the power to your transceiver. Your transceiver is now ready for normal use.



The microprocessor PCB link

The microprocessor link is one that you will have to make and solder on the microprocessor PCB. The PCB (part number 08-03741-001) is positioned on the underside of the transceiver.

The link must only be soldered across the number 2 pads as shown in figure 11.2. A link soldered across pads 2 (called the inhibit link) prevents you from changing the inhibit set-up options on P-channel programming.

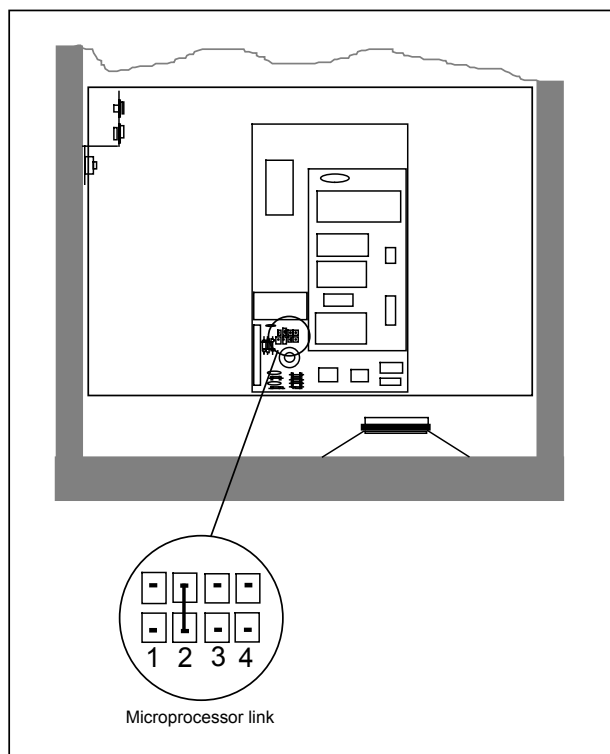

Figure 11.2: The microprocessor link

Inserting the microprocessor PCB link



Extreme care should be taken when handling the transceiver to prevent damage to the components.





This procedure must only be carried out by a qualified technician.

Step	Action
1.	Turn the transceiver off and disconnect the power.
2.	Lay the transceiver on its top with the front panel facing you.
3.	Remove the bottom cover of the transceiver.
4.	Locate the microprocessor PCB and the number 2 pads (refer to figure 11.2). The link must only be fitted across pads 2. Pads 1, 3 & 4 are not used.
5.	Solder a suitable piece of wire across pads 2 (the Inhibit link).
6.	Carry out the relevant set-up procedures.
7.	After completing the set-up procedure, turn the transceiver off and disconnect the power before removing the link.
8.	Replace the cover before reconnecting the power to the transceiver. The transceiver is now ready for normal use.

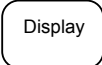

Reviewing set-up options

This facility allows you to see what set-up options have been enabled with the transceiver. You can review the set-up options at any time. This procedure does not require you to move or install links in your transceiver.

Step	Action...	Display shows...	Remarks...
1.	Ensure your transceiver is off.	No display.	
2.	Hold down  and press 	Hold down the Display button until the display shows 	The display starts with the scan set-up option.
3.	To scroll through the options press 	Shows each option.	Each press of the Display button scrolls to the next option. SCAN prog ENAbLE CHAN No inhib diSP S-CALL ENAbLE diSP CALL LONG diSP Addr CALL diSP Addr SELF diSP bEACON ON diSP t1 Hi Lo diSP t2 Hi Lo diSP t3 Hi Lo diSP t4 Hi Lo Ptt CutOut diSP bEEPS loud CALL PHONE OFF Ant Contrl CHAN or bANd







Step	Action...	Display shows...	Remarks...
4.	To exit the review mode and resume normal operations, press the PTT button.		



PTT timer

This facility stops the transceiver from being left on in the transmit state. If the transmit time exceeds the PTT timer setting, the transceiver reverts to the receive mode and an error message is displayed.

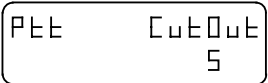
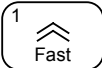
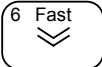
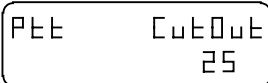
The timer is set at the factory to 10 minutes. You may turn this facility off, or vary the time, in five minute intervals, between 5 and 35 minutes.

Step	Action...	Display shows...	Remarks...
1.	Turn the transceiver off and move the front panel link to position 1.	No display.	Before moving the link, note its original position. Refer to the procedure on page 11-3.
2.	Hold down  and press 	Hold the Tune button down until the display shows 	This turns the transceiver on, and into the PTT timer set-up mode.
3.	Press  or 		The PTT time out time can be changed from 5 to 35 minutes. Press either the  or  buttons to increase or decrease the time. Stop at the setting you require.



Step	Action...	Display shows...	Remarks...
4.	Press 	No display.	Your selection has been made and the transceiver is now switched off.
5.	Return the front panel link to its original position (F or E).		Refer to the procedure on page 11-3.
6.	Replace the cover before switching on your transceiver.		Refer to the procedure on page 11-3.

Note: The PTT timer does not operate when operating through the option PS connector.



Enter a PIN (Personal Identification Number)





If you select a PIN for the transceiver, you will have to enter this PIN each time you switch the transceiver on. If you fail to enter the correct PIN, the transceiver will automatically switch off.





If a PIN code is set, the transceiver can only be operated by entering the PIN.

**It is important that every person who uses the transceiver knows the PIN.
Alternatively, do not set the PIN code.**

Should you forget the PIN, you will have to return the transceiver to the factory.







Step	Action...	Display shows...	Remarks...
1.	Turn the transceiver off and move the front panel link to position 1.	No display.	Before moving the link, note its original position. Refer to the procedure on page 11-3.
2.	Hold down  and press 	Hold down the Tune Rx Fast button until the display shows 	This switches your transceiver on and into the PIN set-up mode.
3.	Use the numeric buttons to enter your PIN.	The display will show the number you enter.	You can select a number between 1 and 999999. 

Step	Action...	Display shows...	Remarks...
4.	Press 		Your PIN number has now been registered within the transceiver.
5.	Press 	No display.	The transceiver is now switched off.
6.	Return the front panel link to its original position (F or E).		Refer to the procedure on page 11-3.
7.	Replace the cover before switching on your transceiver.		Refer to the procedure on page 11-3.







Changing or deleting a PIN

This procedure allows you to change your PIN, or delete it.

Step	Action...	Display shows...	Remarks...
1.	Turn the transceiver off and move the front panel link to position 1.	No display.	Before moving the link, note its original position. Refer to the procedure on page 11-3.
2.	Hold down  and press 	Hold down the Tune Rx Fast button until the display shows 	This switches your transceiver on and into the PIN set-up mode.
3.	Use the numeric buttons to enter your existing PIN		Example of existing PIN number 1234.
	and then press 		You may now change or delete the PIN.

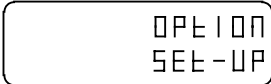

Step	Action...	Display shows...	Remarks...
4.	<p>To insert a new PIN, use the numeric buttons and press</p>  <p>To clear a PIN, do not insert new numbers, just press</p> 	<p>The display will show the number you enter, or if you cleared the PIN</p> 	<p>You can select a number between 1 and 999999.</p> <p>A new PIN is now registered, or the old PIN has been cleared.</p>
5.	<p>Press</p> 	No display.	The transceiver is now switched off.
6.	<p>Return the front panel link to its original position (F or E).</p>		Refer to the procedure on page 11-3.
7.	<p>Replace all covers before switching on your transceiver.</p>		Refer to the procedure on page 11-3.







Power-on settings

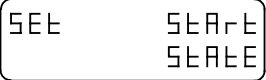

There are two power-on settings that may be set at any time without the need to move or install any internal links. These are the default settings that will always be present when you switch on the transceiver.

- **Mute settings.** This facility allows you to select either Mute On, Mute Off, or S'call Mute on/off (if option SD is fitted).
- **Beep volume.** This facility allows you to set the beep volume to either loud or soft.

Mute settings





Step	Action...	Display shows...	Remarks...
1.	Hold down  and press 	Hold down the Mute On'Off button until the display shows 	This switches your transceiver on and into the Mute set-up mode.
2.	To select either Mute On or Mute Off, press 	No change in the display.	The Mute is on when the indicator is lit. If you wish to select Mute on, proceed to step 4. If you wish to select S'call Mute proceed to step 3.



Step	Action...	Display shows...	Remarks...
3.	To select S'call Mute on, press  to select S'call Mute off press 	No change in the display.	The S'call Mute is on when the indicator is lit.
4.	Press 	Reverts to normal display showing channel and frequency numbers.	Your selection has been made and you can switch off the transceiver.

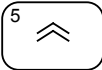

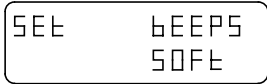
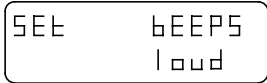
Beep volume

Step	Action...	Display shows...	Remarks...
1.	Hold down  or  and press 	Hold down either of the volume buttons until the display shows  or 	This switches your transceiver on and into the beep volume set-up mode. The display will show the last beep volume setting.
2.	Press either of the volume buttons to switch between the beep volume settings.	The display will switch between SOFT and loud.	
3.	Press 	Reverts to normal display showing channel and frequency numbers.	Your selection has been made and you can switch off the transceiver.



Clear all settings and P-channels

This facility allows you to clear all settings (except the PIN number) and P-channels automatically. Ensure your transceiver is switched off before commencing this procedure.



Do NOT use this facility if you require any of the P-channels. To restore the transmit frequencies may be extremely difficult.





Step	Action...	Display shows...	Remarks...
1.	Hold down <div style="border: 1px solid black; padding: 2px; display: inline-block; margin-bottom: 5px;">Recall</div> and press <div style="border: 1px solid black; padding: 2px; display: inline-block; margin-bottom: 5px;">Power On/Off</div>	Hold down the Recall button until the display shows <div style="border: 1px solid black; padding: 5px; display: inline-block; margin-top: 10px;"> PUSH CLEAR Enter P-CHLS </div>	This switches your transceiver on and into the Clear all settings and P-channels set-up mode.
2.	Press <div style="border: 1px solid black; padding: 2px; display: inline-block; margin-bottom: 5px;">Enter</div> and wait until the display shows dONE.	<div style="border: 1px solid black; padding: 5px; display: inline-block; margin-top: 10px;"> - d O N E - </div>	All settings and P-channels have now been cleared. You can now switch off the transceiver.

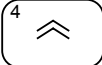

Antenna select output

This procedure changes the output configuration of the antenna control connector to provide either channel or frequency band information. Generally, all transceivers are supplied with this facility set to channel (CHAN).

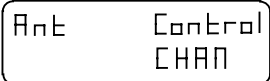
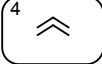
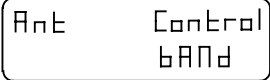
However, where special purpose external linear amplifiers are used and require frequency band selection the transceiver must be set to bANd.

Step	Action...	Display shows...	Remarks...
1.	Turn the transceiver off and move the front panel link to position 1.	No display.	Before moving the link note its original position. Refer to the procedure on page 11-3.
2.	Hold down  and press 		This turns the transceiver on and into the antenna select output mode.
3.	Press 		This changes the operating mode to frequency band selection. Repeated pressing of the  will change from channel to band control.



Step	Action...	Display shows...	Remarks...
4.	Press 	No display.	Your selection has been made and the transceiver is now switched off.
5.	Return the front panel link to its original position (F or E).		Refer to the procedure on page 11-3.
6.	Replace the cover before switching on your transceiver.		Refer to the procedure on page 11-3.





12. Display messages





In addition to showing the normal channel information, the display is able to show messages indicating the results of an operation, such as an operator error or a system error.

These error or fault messages are generally accompanied by one or more 'beeps'.

If a transceiver fault is indicated, the transceiver must be switched off and tried again. If the fault re-occurs the transceiver must be sent to Codan, or a Codan agent, to have the fault rectified.

Messages will be displayed for five seconds and then normal operation will be resumed. Pushing any button or the microphone PTT button during this five second period will immediately restore normal operation.

Messages and operator errors

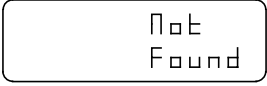
No. of 'beeps'	Message displayed	Meaning
2		The automatic antenna has been satisfactorily tuned.
2		The automatic antenna has failed to tune.
2		An attempt has been made to transmit before the automatic antenna has been tuned. Wait until the automatic antenna has tuned. If a fault exists, refer to the antenna handbook for details.
1		An attempt has been made to enter more than 15 channels in the scan program.
0		Displayed when programming scan and shows that a channel has been entered in the scan program.
1		Channel does not exist.



No. of 'beeps'	Message displayed	Meaning
1		<p>An attempt has been made to transmit on a receive-only channel, or while the scan mode is selected.</p> <p>If the transceiver is scanning, press the Scan button to stop scanning. If the channel selected is a receive-only channel, select another channel.</p>
1		<p>An attempt has been made to select the scan mode while the transceiver is transmitting, or no channels have been entered in the scan program.</p> <p>Check that the program has scan channels, if not select another program.</p>
1		<p>An attempt has been made to program a receive frequency higher than 30,000 kHz or a tone frequency higher than 2800 Hz.</p>
1		<p>An attempt has been made to program a channel with a frequency lower than 250 kHz or a tone frequency of 300 Hz or lower.</p>
0		<p>All 99 P-channels are programmed.</p>



Display messages

No. of 'beeps'	Message displayed	Meaning
1	<div style="border: 1px solid black; padding: 5px; display: inline-block;"> CHL Tx USEd Rx </div>	The nominated channel is already programmed.
1	<div style="border: 1px solid black; padding: 5px; display: inline-block;"> prog inhibit </div>	There are four program inhibit options available. Refer to <i>Inhibit programmed channels</i> in section 11.
1	<div style="border: 1px solid black; padding: 5px; display: inline-block;"> PoE ENABLE </div>	An emergency call, tone call or a selective call has been attempted on a channel where that function has not been enabled.
1	<div style="border: 1px solid black; padding: 5px; display: inline-block;"> Po Rx TUNE </div>	Full inhibit has been programmed.
2	<div style="border: 1px solid black; padding: 5px; display: inline-block;"> PTT CUTEOUT </div>	The microphone PTT has been active for a longer time period than set. Refer to section 11, <i>Changing the set-up options..</i>
1	<div style="border: 1px solid black; padding: 5px; display: inline-block;"> CHL CALL ---- </div>	A request for you to enter a selective call address.
1	<div style="border: 1px solid black; padding: 5px; display: inline-block;"> CALL PHONE OFF </div>	The telephone mode is off.



No. of 'beeps'	Message displayed	Meaning
0	CALL PHONE ON	The telephone mode is on.
1	CALL TEL-No 1234 -----	A request for you to enter a telephone number.
1	STOR TEL-No E_	A request for you to enter a code number for a particular telephone number.
1	DEL TEL-No E_	A request for you to enter a telephone number that you want to delete from memory.
1	CALL DISCON 1234 TEL	Indicates that you can send a disconnect telephone message to the call line between your transceiver and the base station
0	CHL 428 P2 CALLED	An ordinary (not telephone) selective call has been received. This example shows a call received from station 428 on channel P2.
0	CHL 428 P2 E-CALL	A telephone call has been received from station 428 containing telephone number information has been received on channel P2.





Display messages

No. of 'beeps'	Message displayed	Meaning
0	<div style="border: 1px solid black; padding: 5px; display: inline-block;"> CALd Tx 4012 400 Rx 4012 </div>	A call has been received on another channel. Display shows call on channel 400 and frequencies.
0	<div style="border: 1px solid black; padding: 5px; display: inline-block;"> CHL CALLED P2 Rx 12.340 </div>	An ARQ call has been received. In this example, on channel P2 the frequency is 12.340 MHz.
1	<div style="border: 1px solid black; padding: 5px; display: inline-block;"> CALL No TEL prog </div>	Indicates that no telephone numbers have been stored.
1	<div style="border: 1px solid black; padding: 5px; display: inline-block;"> Stor TEL-No E- USEd </div>	A request to store a frequently used telephone number as a single digit.
0	<div style="border: 1px solid black; padding: 5px; display: inline-block;"> SET SEARt SEARtE </div>	Indicates that your transceiver is switched on and in the Mute set-up mode.
1	<div style="border: 1px solid black; padding: 5px; display: inline-block;"> Ant Control CHAN </div>	Indicates that your transceiver is switched on and in the Antenna select output mode.
1	<div style="border: 1px solid black; padding: 5px; display: inline-block;"> Ant Control BAND </div>	Indicates that your transceiver is switched on and in the Frequency band operation mode.

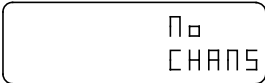

System errors

No. of 'beeps'	Message displayed	Meaning
3		<p>Internal synthesiser is unlocked. All transmission is inhibited and the receiver is muted.</p> <p>Turn the transceiver off and then try again. If the problem persists, the transceiver must be returned for service.</p>
2		<p>The external tuner has not completed a tune operation within five minutes.</p> <p>Turn the transceiver off and then try again.</p>
0		<p>No channels have been programmed into the transceiver.</p>



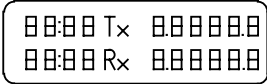
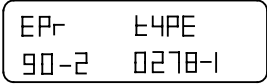
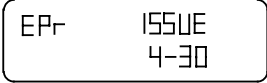
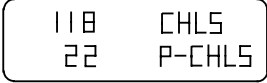

Reviewing the EPROM program content

With the transceiver on, push and hold the Power On-Off button. The display will show the following test displays at three second intervals. On releasing the Power On-Off button the transceiver is turned off.

No. of 'beeps'	Message displayed	Meaning
0		Display lamp test: all segments must be on and all the indicators lit.
0		This shows the Program (EPROM) type number. (example 90-20278-1)
0		Program (EPROM) issue number. (example 4.3). Some indicator lamps will turn off.
0		<p>The top line shows the number of channels programmed by the factory or agent, this can be up to 501.</p> <p>The second line shows the number of channels programmed by the user, this can be up to 99 or 89 with the telephone mode enabled.</p>

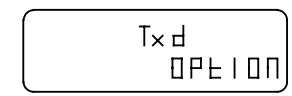
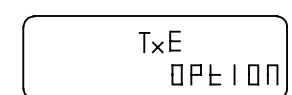
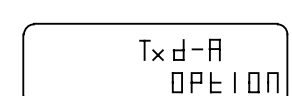

No. of 'beeps'	Message displayed	Meaning
0		<p>These displays indicate some of the options fitted to the transceiver.</p>
		<p>d indicates that the transceiver is inhibited from entering transmit frequencies from the front panel.</p>
		<p>E indicates that the transceiver is enabled for entering transmit frequencies from the front panel.</p>
		<p>A indicates that the transceiver is programmed for use on the amateur band.</p>
		<p>H indicates that the transceiver is set for use with an external power amplifier.</p>

Note: This procedure is repeated in section 4, *Reviewing the EPROM version and options*



Display messages

13. Front and rear panel sockets

Only suitably qualified personnel should use the information contained in this section. Failure to observe the stated and implied criteria could result in damage to the transceiver.

Details are provided on the following sockets:

- microphone socket
- options SD and PP - external alarm and battery power output socket
- option PS - miscellaneous facilities socket
- antenna control socket
- remote control socket.

Microphone socket

This socket is located on the front panel of the transceiver. It is used to connect the microphone to the transceiver.

The transceiver speaker is controlled by a link in this plug. If the microphone is not connected to the transceiver, the internal speaker is disconnected.

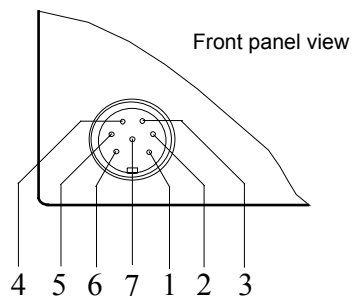

Pin No.	Designation	Pin No.	Designation
1	PTT ground	5	Speaker connection
2	PTT (active low)	6	Audio output
3	Microphone input	7	Audio ground
4	Microphone ground		

If you wish to hear the transceiver speaker with the microphone disconnected, link together pins 5 and 7.



Options SD and PP - external alarm and battery power outlet socket

This socket is located on the rear panel of the transceiver. It can be used to accommodate two facilities:

- **Option SD—selective call alarm**

This facility allows an external alarm device to be connected to the transceiver. When a selective call is detected, internal relay contacts close across pins 2 & 3.

The contacts are rated for 1A at 50V DC.

- **Option PP—unswitched battery power source for external equipment**

This facility allows an external device to be connected to, and draw power off, the transceiver. When the transceiver is switched off, the power source is still available at this socket.

This power source is unswitched battery voltage fused at 5 A.

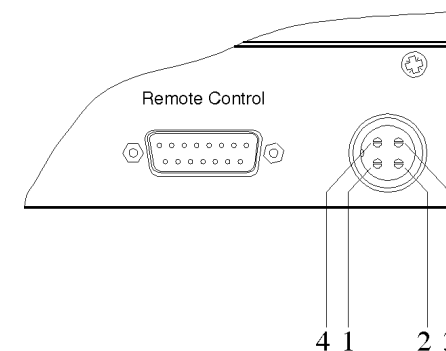

Pin No.	Designation	Pin No.	Designation
1	Battery voltage (⊕ve)	3	Relay contact
2	Relay contact	4	Ground



Option PS - miscellaneous facilities socket

This socket is located on the rear panel of the transceiver. If option PS is fitted to your transceiver, the *Option SD and PP socket* cannot be fitted.

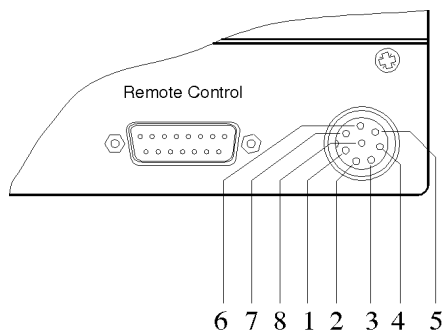

Pin No.	Designation	Pin No.	Designation
1	Ground	5	Alarm tones input
2	Rx output (1.5 Vpp)	6	PTT (active low)
3	Tx input	7	Scan (+10V output)
4	Quiet line (mute +10V)	8	Switched fused battery voltage



Antenna control socket

This socket is located on the rear panel of the transceiver, and allows you to connect an automatic tuning antenna to your transceiver.

There are two options available which determine the connections made to the pins on this socket:

- **Antenna control—standard**

This option allows an 8551 antenna driver or 4203 and 9103 antenna tuner to be connected to the transceiver.

- **Antenna control—option AD**

Fitting of this option is identified with a WARNING label fitted above the antenna control socket.

This option allows an 8558 automatic tuning antenna to be connected to the transceiver.

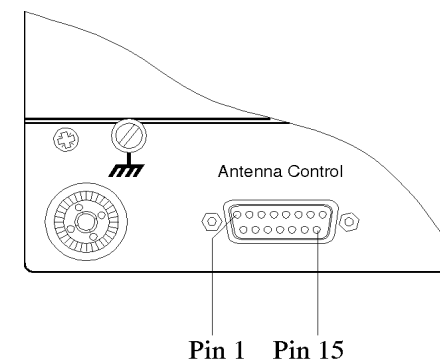

Antenna control—standard

Pin No.	Designation	Pin No.	Designation
1	Channel number Bit 3 (oc)	9	Channel number Bit 1 (oc)
2	Channel number Bit 4 (oc)	10	Channel number Bit 2 (oc)
3	N.C.	11	Tuned in (active low)
4	Tune in/out (active low)	12	Switched fused battery voltage
5	Scan (Active antenna, oc, active low)	13	Switched fused battery voltage
6	N.C.	14	Ground
7	N.C.	15	Ground
8	PTT out (+10V 1k Ω source)		

(oc) = Open Collector (Active high)



Antenna control—option AD

Pin No.	Designation	Pin No.	Designation
1	Channel number Bit 3 (oc)	9	Channel number Bit 1 (oc)
2	Channel number Bit 4 (oc)	10	Channel number Bit 2 (oc)
3	Disable (ground to disable)	11	Switched +12V Motor
4	Load	12	Switched fused battery voltage
5	+ 12V Scan	13	Switched fused battery voltage.
6	Motor phase 1 (oc)	14	Ground
7	Motor phase 2 (oc)	15	Motor phase 3 (oc)
8	Motor phase 4 (oc)		

(oc) = Open Collector (Active high)



Remote control socket

This socket allows the following peripherals to be connected to the transceiver:

- remote control heads 8532 and 8533
- 8571 Remote control interface
- IPC-500 telephone interconnect.

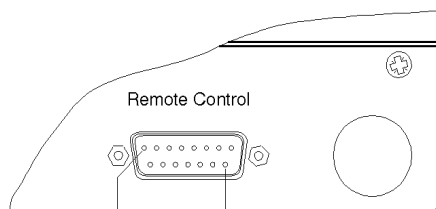

Pin 1 Pin 15

Pin No.	Designation	Pin No.	Designation
1	Loudspeaker	9	Ground
2	Remote PTT (active low)	10	Ground
3	Receiver audio input *	11	Transmit audio input (1.5V pp)
4	Power on (active low, pulse)	12	Receiver demodulator output (1.5V pp)
5	Data (I ² C Bus, 5V)	13	Receiver audio output *
6	Data line enable (I ² C Bus, 5V)	14	Interrupt (I ² C Bus, 5V)
7	Clock (I ² C Bus, 5V)	15	Switched fused battery voltage.
8	Transmit lamp		

* Special: Adjusted to suit attached equipment.



14. Specification

Frequency range	Transmit: 2 to 24 MHz Receive: 250 kHz to 30 MHz
Channel capacity	600. Comprising 501 pre-programmed EPROM controlled channels and 99 front panel operator programmed channels.
Operating mode	Single sideband (J3E; USB) with LSB available as an option.
Transmitted power output	125 watts (PEP). May be set to any output between 25 and 125 PEP. (Approved to DOC specification RB 209 for 100 watts PEP operation in Australia.)
Supply voltage	12V DC nominal, negative earth Normal operating range 10.5V to 15V DC Maximum operating range 9V to 16V DC Reverse polarity protection is provided.
Overvoltage protection	Shutdown at 16V DC (nominal) for duration of overvoltage.
Supply current	Receive (no signal): 0.4A Transmit J3E voice: 6A (average) J3E two tone: 9—12A
Size and weight	8528 transceiver 250 mm W x 320 mm D x 78 mm H; 3.3 kg (excludes vehicle mounting frame) 8532 control head 190 mm W x 50 mm D x 75 mm H; 0.4 kg (includes mounting bracket)



15. Options and accessories

The following options and accessories are available for the 8528 transceiver.

Code	Options
A	Fit amateur band transmit-receive facility (for licensed amateur radio operators). Note that option LU may also be required.
AD	Fit antenna driver interface for 8558 automatic tuning whip antenna.
E	Program RFDS emergency call (Australia only).
F	Fit for continuous data transmission.
LU	Fit for LSB capability in addition to USB.
M	Fit morse facility.
PH	Fit headphone output (front control transceivers only).
*PP	Fit unswitched battery power output facility.
*PS	Fit miscellaneous facilities interface.
R	Fit extended/remote control interface (front control transceivers only).
*RS	Fit RS-232 serial communications interface.
SD	Fit selective call decode facility.
SE	Program selective call encode (specify operating channels).
TD	Fit 2-tone decoder.
TE	Program 2-tone encode (specify frequencies and operating channels).
TXE	Enable front panel programming of transmit frequencies (where permitted by local licensing authorities).

* Combination of PP, RS and PS is not admissible

Code	Accessories
112	Vehicle installation hardware kit.
117	Vehicle mounting cradle - front entry complete with DC power cable (6 metre).
118	Vehicle mounting cradle - top or bottom entry complete with DC power cable (6 metre).
121	2-module clamp suitable for locking 8528 with another item of equipment having the same physical design.
122	3-module clamp suitable for locking 8528 with two other items of equipment having the same physical design.
123	4-module clamp suitable for locking 8528 with three other items of equipment having the same physical design.
164	Rack mounting frame (483 mm) for types 8528 and 8540 - iridescent grey.
602	Headphones complete with cable and connector.
641	Desk microphone complete with cable and connector.
649	Extension loudspeaker.
651PC	Program package - 8525/8528. For use with IBM compatible PC.
652	Morse key complete with base, cable and connector.
654	Telephone handset complete with speaker switch, mounting cradle, cable and connector.
704	Vehicle interference suppression kit.
711	Bulkhead mounting fuse holder for transceiver DC power cord - supplied with 32 amp fuse.
712	32 amp fuse for code 711.
726	Channel decoder (1 of 14) - active low. For use with relay switch antenna systems.
2036	Service manual for type 8525B/8528 series.

8532 Control head complete with 6 metres of interface cable fitted with connectors and hand PTT microphone.

Code Power Supplies and Cables

8540B AC power supply, 13.8 volts DC regulated, rated for continuous duty operation. Includes interface cable and handbook.

9113 Transceiver AC power supply, 13.8 volts 6 amps DC. Suitable for transceivers operating on speech only.

— Adaptor cable for 9113 when used with 8525/8528 transceiver.

702 Cable kit for float charging lead-acid storage battery for uninterrupted supply. Suitable for 8540B and 9113.

507 Heavy duty AC power supply, 27.5 volts, 40 amps DC regulated.

508 Voltage regulator (24 to 12 volt operation).



Appendix A—The 9300 ALE Controller

This appendix describes the operation of the 8528 series transceiver when connected to the 9300 Automatic Link Establishment (ALE) controller. Various operations and settings on the 8528 transceiver are different when used in conjunction with the 9300. Full details of the controller and how to interface it with your transceiver are available in the 9300 ALE Controller User Guide.



Before you can use the 9300 ALE Controller you will need option ‘RS’ fitted to your 8528 transceiver.

ALE operation

The 9300 ALE Controller allows you to automatically establish a transceiver link with another transceiver user.

When you call another station, the 9300 chooses the first suitable frequency from a pre-set list of channels and attempts to establish a link on that channel. If this fails, it selects its next best channel and so on until a link is established.

The 9300 also maintains a database of historical link information.

ALE station addressing

The 9300 ALE Controller automatically adopts the 8528 transceiver's Selective Calling Self Address as its own. For example, if the transceiver's self address is '1234', then the 9300 can be contacted by calling ALE station '1234'.

ALE scanning

You can program up to 15 channels for the 9300 ALE Controller to scan. If the 9300 detects an incoming ALE signal or Selective Calling signal, it will pause to listen to the signal.

When the 9300 receives a valid ALE call, it transmits the appropriate response, tuning the antenna first if necessary.

ALE sounding

To maintain up-to-date information on the quality of its channel set, the 9300 ALE Controller periodically sends a sounding signal. Each station receiving this signal uses it to measure the link quality and updates its internal channel database.

The sounding interval is adjustable in several steps between 30 minutes and 16 hours. The sounding interval is set to 30 minutes by default but you may need to increase this depending on the number of stations in your network.

Each sounding lasts for 5 seconds. Soundings from other stations may interfere with an established voice link. If this is a problem, you can turn sounding off.

LQA exchange

In addition to conducting periodic soundings, the 9300 ALE Controller automatically exchanges Link Quality Analysis (LQA) data with any station it attempts to call or vice-versa.



Setting up the ALE system

Before you can use your 9300 ALE Controller, you must first set the 8528 self-identification address and program a set of channels for scanning.







The 8528 transceiver will transfer this information to the 9300 ALE Controller when the transceiver is first turned on. If an ALE Controller is not connected, the 8528 will revert to normal operation.

In addition to the above settings, you can modify the Sounding interval and alter the operation of the Selcall Mute.

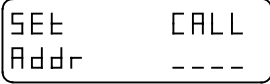

Refer to the *'9300 ALE Controller User Guide'*.

Setting the self-identification address

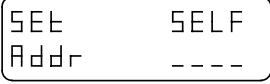
The 9300 ALE Controller uses the same address as the 8528's Selective Calling self-identification address. This address is automatically transferred to the 9300 from the 8528 when the units are first turned on. The procedure for setting the self-identification address is as follows:

Step	Action...	Display shows...	Remarks...
1.	Hold down  and press 		Hold the Call button down for approximately three seconds. This turns the transceiver on and into the preamble set-up mode. Use any numeric key for changing the preamble mode (LONG, SHORT or ALE). Refer to page A-8.
2.	Press 		Once call has been pressed, you are in called address set up mode.
3.	Press 		Once call has been pressed, you are ready to set the self-identification address.



Step	Action...	Display shows...	Remarks...
4.	Use the numeric buttons to enter the self-identification address number. E.g. Type 4012. To delete an address, enter four zeros.		You can override an existing address by entering a new number. Your station address can be from 1 to 4 numbers in length.
5.	Press 		Once Enter has been pressed, the self identification address has been set and can only be changed by repeating this procedure.

Refer to section 5-7, 'Setting the self-identification address'.





Note: The address you set will not be transferred to the ALE Controller until the transceiver is next switched on.



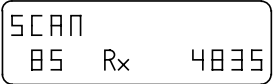
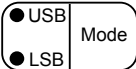
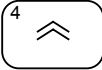

Programming the channels to scan

The channels which the 9300 ALE system will scan are those programmed using the normal 8528 transceiver scan programming procedure. This procedure is outlined below:

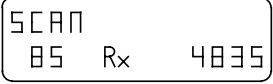
Ensure your transceiver is switched on and scan program has been enabled.

Step	Action...	Display shows...	Remarks...
1.	Press  and then  within one second.		The Scan button indicator flashes. Any previous programming of channels to be scanned will be erased.
2.	Select the required mode Press 		The appropriate mode indicator will light.
3.	Select the relevant channel Press  or 		Refer to section 4, <i>Selecting channels</i> . Channels required to operate on selective call must be enabled. Refer to section 5, <i>Enabling a channel for selective call</i> .

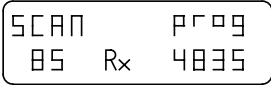

Step	Action...	Display shows...	Remarks...
4.	Press 		The channel is programmed for scanning. Repeat this procedure from step 3 until all channels you want to scan have been programmed.
5.	Press  and then  within one second.		The channels you have programmed are now registered within the transceiver.

Refer to section 6-6, 'Programming the channels to be scanned'.

Notes: If you want to scan for selective calls as well as ALE calls, do not program more than 8 scan channels unless other stations in the network have selected the ALE preamble. Refer to page A-8.

The channels you program will not be transferred to the 9300 ALE Controller until the transceiver is next switched on.



Setting the preamble time period

In addition to a SHORT/LONG preamble (via Power-On + Call key sequence), the 8528 supports an ALE preamble selection when used with the 9300.

Refer to section 5-4, '*Setting up selective call*' and '*Setting the self-identification address*'.





The ALE signal preamble must be long enough to cater for the number of channels used by the remote station. The 8528 transceiver calculates the preamble length automatically based on the number of scan channels used.

If your 8528 scans fewer channels than other stations in the network you should use the ALE preamble setting. This setting uses a preamble corresponding to 15 channels. This selection also extends the Selcall preamble length to 12 seconds.

Set Call	Sell Preamble (secs)	ALE Preamble
Short	2	Automatic
Long	6	Automatic
ALE	12	15 channels

Changing the sounding interval

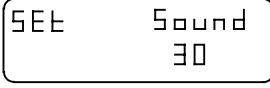
You can turn sounding off altogether, or you can adjust the interval between soundings from 30 minutes to 16 hours. It is set to 30 minutes by default.

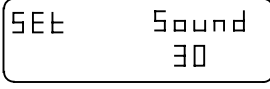
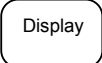
Step	Action...	Display shows...	Remarks...
1.	Ensure power is supplied to your transceiver.		
2.	Press  while holding 		
3.	Use channel  &  keys to select desired sounding interval.		
4.	Press 	Normal channel display.	

Note: The sounding interval you program will not be transferred to the ALE Controller until the transceiver is next switched on.



Using the 9300

The 9300 ALE Controller has no operator controls. All operation is conducted using the 8528 transceiver front control panel.

Scanning



Once you have programmed the channels to be scanned, you can turn Scanning on and off using the Scan button.

Channels are scanned at the rate of 0.75 seconds per channel.

An automatic timer causes scanning to start or resume after 2 minutes of inactivity.

Turning on Scan automatically selects Selcall Mute.

Pressing the PTT button while the system is scanning causes scanning to stop. The first channel programmed in the scan programming sequence is automatically selected. This is a useful feature for selecting a particular channel in an emergency situation.







Note: Unlike normal Selcall scanning, the scan rate or number of channels scanned is the same irrespective of the transceiver's mute setting.



Calling a remote ALE station

To call an ALE station you dial the station address, in the same way as making a Selective Beacon Call.

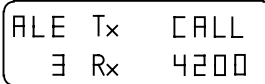
Note: You do not need to turn scanning off before making a call.

Step	Action...	Display shows...	Remarks...
1.	Press 		
2.	Use number keys to enter the desired address (e.g. 1234).		Display shows channel number in preset scan list and the destination station ID.
3.	Press 		Display shows channel number in preset scan list and the frequency for the channel.
4.	When a successful link is made, the transceiver beeps and displays...		
5.	If no link is made, the transceiver beeps and displays...		









Step	Action...	Display shows...	Remarks...
6.	Once a link is established, press 		This causes a termination message to be sent to the remote end and scanning resumes.

When a link is successfully made the Selcall Mute is automatically opened, ready for you to speak to the person you have called. Scan resumes automatically after 2 minutes of inactivity.



Making a selective call to an ALE station

Before making a call you must stop scanning and select a channel. To call another station you simply dial the station address.

Step	Action...	Display shows...	Remarks...
1.	Press 		To stop scanning
2.	Press 		
3.	Use number keys to enter the desired address (1234 in this example).		
4.	Press 		Display shows channel number and call address.
5.	When a successful call is made, you hear revertive signals from remote station.	Normal channel display.	



Step	Action...	Display shows...	Remarks...
6.	Press 		To resume scanning after you have finished talking.

Note: Scanning will resume automatically after 2 minutes of inactivity.



Receiving an ALE call

If your 8528 transceiver receives an ALE call, whether it is scanning or not, it will beep and display 'CALL PASS' to indicate that an ALE link has been successfully established. The Selcall Mute will automatically open when a call is received.

When a sounding signal is received, channel quality information is derived from it and stored. This information is used to select a suitable channel for transmission.

Note: If you want, you can make the transceiver emit a very short beep every time a sounding signal is heard. This is a useful method of discerning the level of network sounding activity. To enable this facility, fit link 4 on the microprocessor PCB of the 8528 transceiver.

Refer to section 11, *'The microprocessor PCB link'*.











9300 settings

The 9300 ALE Controller has 17 system settings and 8 memory purge options which can be modified using the 8528 transceiver control panel.

Refer to the *'9300 ALE Controller User Guide'*.

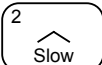



The following steps show how to modify these system settings and make use of the memory purge options.

Step	Action...	Display shows...	Remarks...
1.	Press  &  buttons together to get into the ALE setup mode.	 Displays System Option 00 which has current setting of nn.	
2.	Press  or  button.	 Displays System Option 01 which has current setting of nn.	Pressing the Enter button saves any changes made, whereas pressing the ALE button skips to the next option setting without saving changes.
3.	Press  or 		Use slow or fast buttons to increment or decrement the value. Use the Display button to terminate the 9300 setting mode. The Fast button will only work for options 05, 08, 09, 10, 13 and 16.

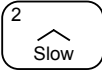
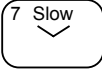

Step	Action...	Display shows...	Remarks...
4.	Press <div style="border: 1px solid black; padding: 2px; display: inline-block; margin-bottom: 5px;">Enter</div> or <div style="border: 1px solid black; padding: 2px; display: inline-block; margin-bottom: 5px;">ALE</div> button.	<div style="border: 1px solid black; padding: 5px; display: inline-block;"> SEE ALE 02 nn </div>	If Enter is pressed, System Option 01 is programmed with value 01. Otherwise the change is discarded. System Option 02 is now displayed.
5.	Press <div style="border: 1px solid black; padding: 2px; display: inline-block; margin-bottom: 5px;">Enter</div> or <div style="border: 1px solid black; padding: 2px; display: inline-block; margin-bottom: 5px;">ALE</div> button 14 more times.	<div style="border: 1px solid black; padding: 5px; display: inline-block;"> SEE ALE 16 nn </div>	Displays System Option 16 which has current setting of nn.
6.	Press <div style="border: 1px solid black; padding: 2px; display: inline-block; margin-bottom: 5px;">Enter</div> or <div style="border: 1px solid black; padding: 2px; display: inline-block; margin-bottom: 5px;">ALE</div> button.	<div style="border: 1px solid black; padding: 5px; display: inline-block;"> CLR ALE TYPE 0 </div>	Quick Purge is the first of the 8 memory purge options. Refer to the '9300 ALE Controller User Guide'. Press Enter to clear (send 'type 0') or press the ALE button to skip the setting without clearing ALE.



Step	Action...	Display shows...	Remarks...
7.	Press  or 		Displays the next memory purge option—Full purge. Refer to the <i>'9300 ALE Controller User Guide'</i> . Press Enter to clear (send 'type 1') or press the ALE button to skip the setting without clearing ALE.
8.	If Enter was pressed...		Displays until clearing is completed then skips to next memory purge setting.
9.	If ALE was pressed...		Skips back to initial display (step 1).





Note: After 9300 option programming and resetting you should switch the 8528 transceiver off and back on again to ensure the changes have taken effect.

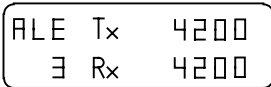

Disabling the 9300 ALE Controller

When the 8528 transceiver powers up, it automatically detects the presence of the 9300 ALE Controller and enables the ALE facilities as described in this appendix.

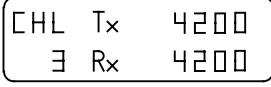
When ALE mode is active, the Selective Beacon and normal channel scan facilities are replaced by ALE Call and ALE Scan respectively. If you need to use these facilities or you wish to temporarily disable the 9300, you can do so by pressing the ALE button.

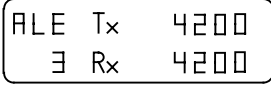
Step	Action...	Display shows...	Remarks...
1.			ALE functions active.
2.	Press  button.		ALE disabled.
3.	Press  button.		ALE functions active.



HF Link establishment time

The HF link establishment time will depend on channel conditions at the time a link is attempted and the number of channels to be scanned.

The worst case link time is the time for the transceiver to report a call fail error (i.e. no answering stations). This depends on the number of channels selected, as shown in the table:

No. of channels	Worst case link time (secs)
1	20
8	120
15	160



Limitations

The limitations below are inherent in the implementation of the 9300 ALE Controller and its interface to the 8528 transceiver. Many arise due to compromises made to minimise the complexity of the system.

- A maximum of 15 channels can be scanned.
- Multiple self identification addresses and channel groups cannot be programmed without an external computer.
- A maximum scan speed of 0.75 seconds per channel is required to ensure reliable Selcall operation.



