



INSTRUCTION MANUAL

LPD FM HANDHELD TRANSCEIVER

**IC-4008E**

---

---

---

---

Icom Inc.

---

---

# FOREWORD

---

Thank you for purchasing the IC-4008E LPD (Low Power Device) FM transceiver. This LPD FM transceiver meets the European LPD specification (ETS 300 220). This transceiver is designed for those who require top-grade quality, performance and outstanding reliability under the most demanding conditions.

---

# FEATURES

---

- *Free of user-license and applications*
- *All 69 LPD channels are available*
- *38 convenient group channels*
- *Water-resistant construction*

## ■ **ATS (Automatic Transponder System)**

This convenient function automatically checks station availability within the operating range, and alerts you via function display indication. (p. 17)

In addition, a manual transponder is also available for “GROUP MODE” operation to check availability of stations in a specified group within the operating range. In this case, the transceiver alerts you via beeps. (p. 11)

---

## ■ WATER-RESISTANT\* CONSTRUCTION

Water-resistant\* construction is employed. Can be used anywhere, anytime.

\*Meets JIS water-protection specification grade 4.

## ■ GROUP MODE (BUILT-IN CTCSS: Continuous Tone Coded Squelch System)

CTCSS encoder/decoder are standard, providing quiet stand-by. Audio (voice) signals are output only when a signal with matched CTCSS tone signal is received—very helpful for group communications. In addition, 38 different CTCSS frequencies are available. (p. 11)

## ■ 2 types of “Ring” function

The “Smart-Ring” function and the “Call-Ring” function are available for smart and simple station calls providing a telephone-style ring when called. 10 different ringing tones are available. (p. 14)

---

# SUPPLIED ACCESSORIES

---

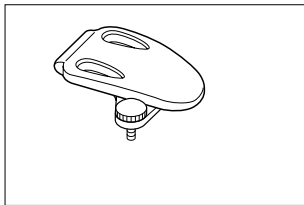

- Belt clip . . . . . 1 set

---

## IMPORTANT

---

**READ ALL INSTRUCTIONS** carefully and completely before using the transceiver.

**SAVE THIS INSTRUCTION MANUAL**—This instruction manual contains important operating instructions for the IC-4008E LPD transceiver.

---

## CAUTIONS

---

**⚠ WARNING! NEVER** hold the transceiver so that the antenna is very close to, or touching exposed parts of the body, especially the face or eyes, while transmitting. The transceiver will perform best if the microphone is 5 to 10 cm (2 to 4 in.) away from the lips and the transceiver is vertical.

**⚠ WARNING! NEVER** operate the transceiver with a headset or other audio accessories at high volume levels.

**DO NOT** push the PTT when not actually desiring to transmit.

**AVOID** using or placing the transceiver in direct sunlight or in areas with temperatures below  $-10^{\circ}\text{C}$  ( $+14^{\circ}\text{F}$ ) or above  $+55^{\circ}\text{C}$  ( $+131^{\circ}\text{F}$ ).

**DO NOT** modify the transceiver for any reason.

The use of non-Icom battery packs/chargers may impair transceiver performance and invalidate the warranty.

---

# TABLE OF CONTENTS

---

FOREWORD	i
FEATURES	i-ii
SUPPLIED ACCESSORIES	ii
IMPORTANT	iii
CAUTIONS	iii
TABLE OF CONTENTS	iv
<b>1 PANEL DESCRIPTION</b>	<b>1-3</b>
■ Switches, controls, keys and connectors	1-2
■ Function display	3
<b>2 ACCESSORIES</b>	<b>4</b>
<b>3 BATTERY PACKS</b>	<b>5-7</b>
■ Installing batteries in the battery case	5
■ Battery pack charging	6
■ Charging precautions	6
■ About the battery pack	6
■ Charging connections	7
<b>4 BASIC OPERATION</b>	<b>8-9</b>
■ Power ON	8
■ Adjusting the volume	8
■ Selecting the operating channel	9
<b>5 RECEIVE AND TRANSMIT</b>	<b>10</b>
<b>6 GROUP MODE</b>	<b>11-13</b>
■ Setting the group code	11
<b>7 RING FUNCTION</b>	<b>14</b>
■ Smart-Ring	14
■ Call-Ring	14
<b>8 OTHER FUNCTIONS</b>	<b>15-19</b>
■ Initial set mode	15-16
■ Automatic transponder system	17
■ Low battery indicator	17
■ LCD backlight	18
■ Auto power save	18
■ Resetting the transceiver	18
■ Optional HM-75A functions	19
<b>9 SPECIFICATIONS</b>	<b>20</b>
<b>10 OPTIONS</b>	<b>21</b>
<b>11 MEMO</b>	<b>22-26</b>
■ Channel number and group number	22
<b>12 CE</b>	<b>25</b>
■ DECLARATION OF CONFORMITY	26

# 1 PANEL DESCRIPTION

## ■ Switches, controls, keys and connectors

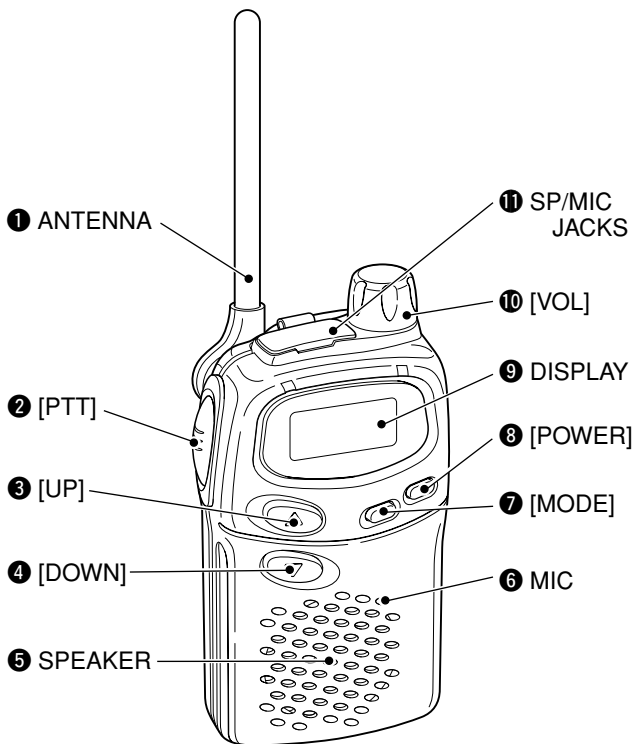

**1 ANTENNA**

Extend the antenna completely when using the transceiver.

- The antenna collapses completely into the transceiver body for carrying purposes.
- The antenna can be adjusted 90 degrees from the regular position when operating the transceiver in a horizontal position.

**2 PTT SWITCH [PTT]**

- Push and hold to transmit; release to receive.
- While pushing [PTT], push [POWER] to activate the “PTT hold function”. (p. 16)

**3 CHANNEL UP SWITCH [UP]/[▲]**

- Push to increment the operating channel.
- Push and hold to increment the operating channel continuously.

**4 CHANNEL DOWN SWITCH [DOWN]/[▼]**

- Push to decrement the operating channel.
- Push and hold to decrement the operating channel continuously.

**5 SPEAKER****6 MICROPHONE [MIC]****7 MODE SWITCH [MODE]**

- Push to toggle between Group mode and Normal mode. (p. 11)
- Push and hold for 1 sec. to force the squelch open; push and hold for 1 sec. to close it again. (p. 8)

**8 POWER SWITCH [POWER]**

- Push to turn the power ON.
- Push and hold this key to toggle the key lock function ON/OFF. (p. 16)

**9 FUNCTION DISPLAY (p. 3)****10 VOLUME CONTROL [VOL]**

Rotate clockwise to increase and counterclockwise to decrease volume.

**11 EXTERNAL SPEAKER AND MICROPHONE JACKS**

Connect an optional speaker-microphone or headset, if desired.

# 1 PANEL DESCRIPTION

## ■ Function display

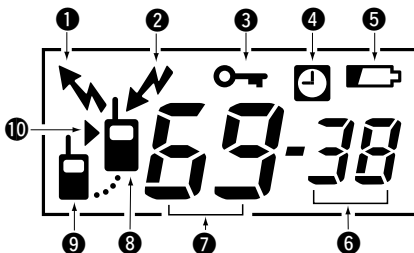

### 1 TRANSMIT INDICATOR

Appears during PTT on.

### 2 BUSY INDICATOR

Appears while receiving a signal or when the squelch is open.

### 3 KEY LOCK INDICATOR

Appears during key lock function ON.

### 4 AUTO POWER OFF INDICATOR

Appears while the auto power off function is ON. (see p. 15)

### 5 LOW BATTERY INDICATOR

Appears or flashes when battery power has decreased to a specified level.

### 6 GROUP NUMBER INDICATION

One of 01 to 38 appear while the Group function is turned ON.

### 7 CHANNEL NUMBER INDICATOR

Indicates operating channel number.

### 8 POWER ON INDICATOR

Appears while the power is ON.

### 9 ANSWER BACK INDICATOR (see p. 17)

- Appears when you and your group are in the conversation area.
- Blinks when you or your group is out of the conversation area.

### 10 PTT HOLD INDICATOR (see p. 16)

- Appears when the "PTT HOLD" function is turned ON.
- Blinks while the transceiver is transmitting.



## ■ Accessory attachment

### ◇ Antenna

Adjust the antenna position as shown at right.

**Keep** the jack cover attached when jacks are not in use to avoid bad contacts.



### ◇ Belt clip

Attach the belt clip using the supplied screws. Conveniently attaches to your belt.

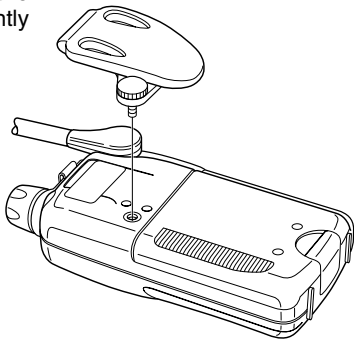

# 3 BATTERY PACKS

## ■ Installing batteries in the battery case

Install 3 R6(AA) size alkaline, dry cell batteries or the BP-202 BATTERY PACK as illustrated below.

- ① Remove the battery case cover from the transceiver.

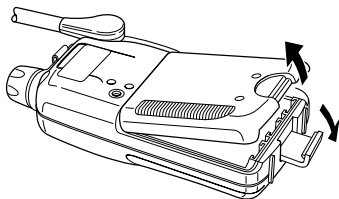

- ② Install 3×R6(AA) size dry cell, alkaline batteries or the BP-202.
  - Be sure to observe the correct polarity.

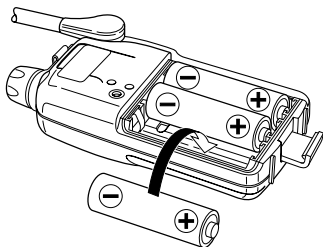

**NOTE:** Keep battery contacts clean. It's a good idea to clean battery terminals once a week.

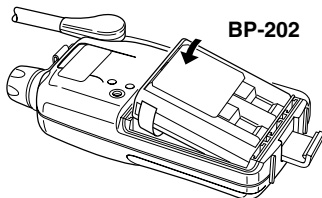

## ■ Battery pack charging

The optional BP-202 BATTERY PACK includes rechargeable Ni-Cd batteries and can be charged approx. 300 times. Charge the battery pack before first operating the transceiver or when the battery pack becomes exhausted.

If you want to be able to charge the battery pack more than 300 times, the following points should be observed:

1. Avoid overcharging. The charging period should be less than 48 hours.
2. Use the battery until it becomes almost completely exhausted under normal conditions. We recommend battery charging just after transmitting becomes impossible.

## ■ Charging precautions

**NEVER** attempt to charge dry cell batteries. This will cause internal liquid leakage and damage the battery case and transceiver.

Recommended temperature range for charging: + 10°C to + 40°C (or + 50°F to +104°F).

## ■ About the battery pack

### ◇ Operating period

Depending on the attached battery pack, the operating period of the transceiver varies. Refer to p. 7 for operating period details.

### ◇ Battery pack life

If your battery pack seems to have no capacity even after being fully charged, completely discharge it by leaving the power ON all day. Then, fully charge the battery pack again.

If the battery pack still does not retain a charge (or very little), a new battery pack must be purchased.

## ■ Charging connections

### ◇ Rapid charging with the BC-119L/BC-119+AD-89

- ① Insert the optional AD-89 DESKTOP CHARGER ADAPTER into the charging slot of the BC-119.
  - The BC-119L comes preinstalled with the AD-89 CHARGING ADAPTER.
- ② Insert the battery pack, either by itself or attached to the transceiver, into the charger.  
(See BC-119/L instructions.)

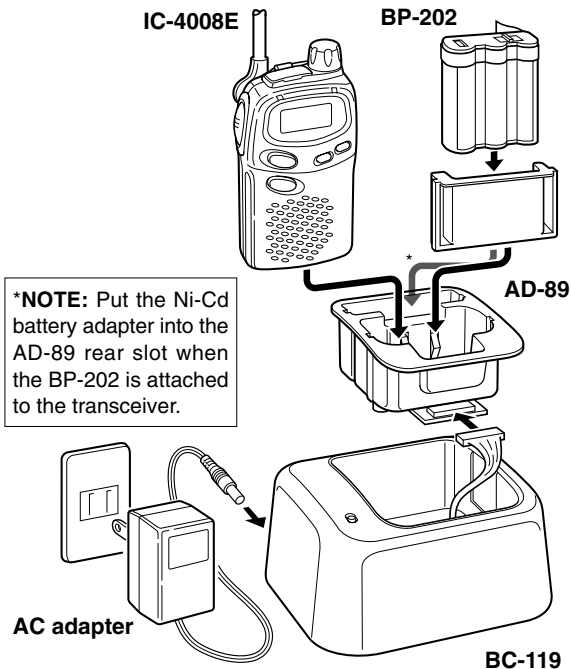

## ■ Power ON

➔ Push [POWER] for 1sec. to turn the power ON.

- The power on indicator and operating channel number appear on the display.

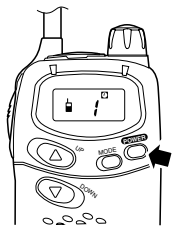

## ■ Adjusting the volume

- ① Push and hold [MODE] for 1sec. to open the squelch.
  - Busy indicator appears on the display while the squelch is open.
- ② Adjust the audio to a suitable level using [VOL].
- ③ Push and hold [MODE] for 1sec. to close the squelch.

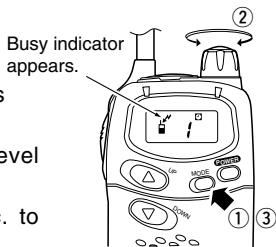

### ✓ *What is squelch?*

A squelch circuit allows you to mute undesired noise while receiving no signal and emit audio while receiving signals.

This provides quiet standby. The [MODE] key changes the squelch setting. This is useful to listen to weak signals that do not open the squelch.

### ■ Selecting the operating channel

Push [UP]/[▲] or [DOWN]/[▼] keys several times until the desired operating channel number appears on the display.

- While pushing and holding [UP]/[▲] or [DOWN]/[▼] keys, the displayed channel changes continuously until channel number “1” appears.

If you want to keep the automatic selection, release the [UP]/[▲] or [DOWN]/[▼] keys then push and hold them again.

- When displayed channel stops at channel number “01”, a warning beep is emitted.



#### NOTE:

- The transceiver has 69 operating frequency channels.
- The selected channel is memorised when you turn off the transceiver.

# RECEIVE AND TRANSMIT 5

- ① Push and hold [MODE] 1sec. to open the squelch.
  - Adjust volume to the desired audio level. (See p. 8)
- ② Select a desired operating channel. When a signal is received:
  - Squelch opens and audio is emitted from the speaker.
  - Further adjustment of [VOL] may be necessary at this point.
  - “BUSY” indicator appears on the display.
- ③ Push and hold [PTT] to transmit then speak into the microphone.
  - Do not hold the transceiver too close to your mouth or speak too loudly. This may distort the signal.
  - The transmit indicator “ ” appears on the display.
- ④ Release [PTT] to return to receive.

Busy indicator appears.



## IMPORTANT:

To maximize the readability of your transmitted signal, pause a few sec. after pushing [PTT], hold the transceiver 4 to 6 inches (10 to 15 cm) from your mouth and speak at a normal voice level.

## NOTE:

The transceiver has an auto power save function to conserve the battery power. The power save function activates automatically when no signal is received for 5 sec.

# 6 GROUP MODE (CTCSS)

## ■ Setting the group code

The IC-4008E is equipped with 38 group codes. Group mode operation provides communication with silent standby since you will only receive calls from group members using the same group number.

First of all, set the same group code number for all group member's transceivers.

### **Turn ON the group mode operation:**

- ① Push [MODE] to enter set mode.
  - “ --- ” (group mode OFF) appears on the display.
- ② Push [UP]/[▲] or [DOWN]/[▼] to select the desired code number.
- ③ Push [MODE] to set the group code number.



### **Cancel the group mode operation:**

- ① Push [MODE] to enter set mode.
  - Code number disappears on the display.
- ② Push [UP]/[▲] or [DOWN]/[▼] to select “ --- ” (group mode OFF).
- ③ Push [MODE] to cancel the group mode.

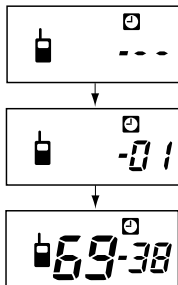

**NOTE:** Only stations with the same group channel number can be heard during group mode operation, even when the busy indicator appears on the display.



✓ **What is CTCSS (Continuous Tone Coded Squelch System) GROUP MODE ?**

CTCSS (Continuous Tone Coded Squelch System) GROUP MODE allows communication with silent stand by. Only signals containing your group code can open the squelch.

This conveniently eliminates unwanted audio and is useful in group activities or security related activities where unwanted output can be a problem. Note that CTCSS group mode is not private—anyone can receive your calls.

The IC-4008E is equipped with 38 tone codes for CTCSS GROUP MODE use. Selecting a code applies it to all 69 operating channels. Each push of [PTT] superimposes your group code over your transmit signal; and, only signals containing the same code can open your squelch. To temporarily hear all signals (including noise) push and hold [MODE]. Do not use CTCSS GROUP MODE if you want to be able to hear signals on all channels.

◇ **CTCSS code table**

CH	Freq.	CH	Freq.	CH	Freq.	CH	Freq.
01	67.0	11	97.4	21	136.5	31	192.8
02	71.9	12	100.0	22	141.3	32	203.5
03	74.4	13	103.5	23	146.2	33	210.7
04	77.0	14	107.2	24	151.4	34	218.1
05	79.7	15	110.9	25	156.7	35	225.7
06	82.5	16	114.8	26	162.2	36	233.6
07	85.4	17	118.8	27	167.9	37	241.8
08	88.5	18	123.0	28	173.8	38	250.3
09	91.5	19	127.3	29	179.9	---	OFF
10	94.8	20	131.8	30	186.2		

(unit: Hz)

✓ **Talk Range**



The IC-4008E is designed to maximize performance and improve transmission range in the field. However, the single most important factor in transmit range (talk power) is your surrounding environment. These radios are “line of sight” radios and as such, transmission range is influenced by the degree to which you can “see” the other communicating party. Large concrete structures and heavy foliage or transmission from inside a building or vehicle will reduce your talk power.

- Optimal range: wide, open areas free of obstructions.
- Medium range: large buildings or trees blocking your line of sight.
- Minimum range: mountainous areas or areas of heavy foliage.

# RING FUNCTION 7

## ■ Smart-Ring

The ring function has an answer back feature. This allows you to confirm whether or not a call has reached the receiving party even if the operator is temporarily away from the transceiver.

- ① Set the same group channel number for all of your group transceivers. (See left.)
- ② While pushing [PTT], push [UP]/[▲].
  - A beep is emitted and “A line drawing of a handheld transceiver. The LCD screen displays '69-38' and a small mobile phone icon. Two black arrows point to the controls: one points to the [UP] button (marked with a triangle) and the other points to the [PTT] button (marked with a triangle and 'PTT'). Other buttons like [MODE] and [POWER] are also visible.

**NOTE:** This function is available only when the called station has set the same group number and the same operating channels as you.

## ■ Call-Ring

Sends the ring tones during transmit mode.

- ➔ While pushing [PTT], push [DOWN]/[▼] to send a ring tone.
- The ring tone is emitted while pushing [DOWN]/[▼].
  - The microphone signal is automatically cut while pushing [DOWN]/[▼].

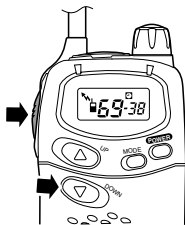

# 8 OTHER FUNCTIONS

## ■ Initial set mode

Initial set mode is accessed at power ON and allows you to set seldom changed settings. In this way you can “customize” transceiver operations to suit your preferences and operating style.

### ◇ Auto power OFF

This function sets the transceiver to automatically turn OFF after 2 hours elapse.

- ① While pushing [MODE], push [POWER] ON to toggle the function ON or OFF.
- ② “” appears on the display.
  - “Auto power OFF” function retains its setting after power OFF.



### ◇ Ring tone type

You can select the ring tone from one of 10 sounds.

- ① While pushing [UP]/[▲], push [POWER] ON.
- ② Push [UP]/[▲] or [DOWN]/[▼] to select the ring sound.

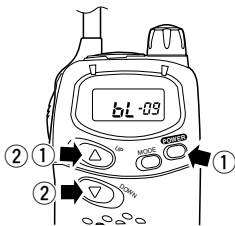

### ◇ Beep tones ON/OFF

Confirmation beep tones normally sound when you push a key. These can be turned ON or OFF.

- ➔ While pushing [DOWN]/[▼], push [POWER].



### ◇ PTT hold function

This function frees you from having to constantly push [PTT] during conversation.

- ① While pushing [PTT], push [POWER] ON to toggle the function ON or OFF.
- ② “▶” appears on the display when the “PTT hold” function is activated.



- ③ Once [PTT] is pushed, you need not hold it any longer during your conversation.
  - “↖” appears and “▶” blinks on the display.
- ④ Push [PTT] to end the conversation.
  - “↖” disappears and “▶” stops blinking.

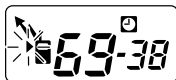

### ◇ Lock function

This function electronically locks all keys and switches to prevent accidental channel changes and function access.

Lock indicator appears.



- ➡ Push and hold [POWER] for 2 sec. to turn the lock function ON and OFF.
  - “🔒” appears on the display.
  - Only [POWER] and [PTT] are functional.
  - The Ring function is also available. (See p. 14)



## ■ ATS (Automatic Transponder System)

This allows you to confirm whether or not a call has reached the receiving party even if the operator is temporarily away from the transceiver. No “Ring” tone is emitted with this function.

➔ Push [MODE], while [PTT] is ON to turn the function ON/OFF.

- “” appears on the display.
- The transceiver starts to send a searching signal every 60 sec.
  - When the transceiver receives an answer back signal, “” stays on the display until the next search transmit.
  - If no reply is received, “” blinks until the next search transmit.

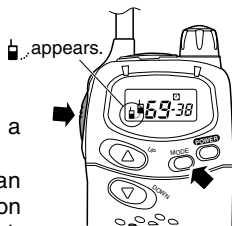

**NOTE:** Above setting is for the calling station only. A called party automatically sends an answer back signal without any presettings.

All IC-4008E's operating on the same operating channel will answer back to your call in your communication area.

## ■ Low battery indicator

- ➔ Appears when the battery is nearing exhaustion.
  - A warning beep is emitted while turning the power ON.
- ➔ Appears and blinks when battery replacement is necessary.

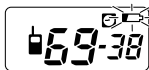
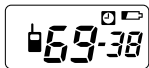

## ■ LCD backlight

- Automatically turns ON for 5 sec. when you push any key, except [PTT].

## ■ Auto power save

- The power save function reduces the current drain to conserve battery power.
  - The function automatically turns ON when no operation is performed or no signal is received for 5 sec.

## ■ Resetting the transceiver

Initialize the operating conditions before using the transceiver for the first time, or if the function display shows erroneous information.

- While pushing [DOWN]/[▼] and [MODE], push [POWER] ON to initialize the transceiver.



**CAUTION:** Resetting the transceiver returns all settings to their defaults.

## ■ Optional HM-75A functions

The optional HM-75A allows you to remotely select operating channels, open the squelch, etc. The switches on the HM-75A function as follows.

**CAUTION:** When connecting the HM-75A to the transceiver, make sure that power to the transceiver is turned OFF, otherwise the transceiver may malfunction.

SWITCH	NORMAL	While holding [PTT]
<b>A</b>	Smart-Ring	No function
<b>B</b>	Open squelch	No function
<b>UP</b> △	Change the operating channel number up.	Smart-Ring
<b>DOWN</b> ▽	Change the operating channel number down.	Call-Ring

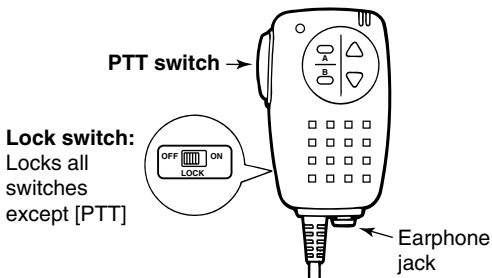



## GENERAL

- Frequency coverage : 433.075–434.775 MHz
- Mode : F3E (FM)
- No. of operating ch. : 69 (simplex)
- Frequency stability :  $\pm 5.7$  ppm;  $\pm 2.5$  kHz
- Frequency resolution : 25 kHz
- Power supply requirement: 4.5 V (R6  $\times$  3) or BP-202
- Current drain : Less than 140 mA
- Operating temp. range :  $-10^{\circ}\text{C}$  to  $+55^{\circ}\text{C}$  ( $+14^{\circ}\text{F}$  to  $+131^{\circ}\text{F}$ )
- No. of CTCSS freq. : 38
- Dimensions : 55.5(W) $\times$ 102.5(H) $\times$ 26.5(D) mm  
(projections not included)
- Weight : 180 g (including 3 R6 batteries)

## TRANSMITTER

- Output power : Less than 10 mW ERP
- Maximum deviation :  $\pm 5.0$  kHz
- Spurious emissions : Less than 250 nW (Less than  $-36$  dBm)
- Ext. mic. connector : 3-conductor 2.5 (d) mm/2.2 k $\Omega$

## RECEIVER

- Receive system : Double-conversion superheterodyne
- Audio output power : More than 100 mW at 10 %  
(at 4.5 V DC) distortion with an 8  $\Omega$  load
- Ext. speaker connector : 2-conductor 3.5 (d) mm/8  $\Omega$

**All stated specifications are subject to change without notice or obligation.**

# 10 OPTIONS

## ◇ Battery packs

### **BP-202** Ni-Cd BATTERY PACK

3.6V/ 700 mAh rapid charge battery pack. (p. 6–7)

## ◇ Chargers

### **BC-119** DESKTOP CHARGER + **AD-89** DESKTOP CHARGER ADAPTER

Rapidly charge battery packs in 1 to 1.5 hrs. An AC adapter is packed with the BC-119. The AD-89 must be used with the BC-119 for charging the battery pack. The CP-17L or OPC-515 can be used instead of the supplied AC adapter. (p. 7)

### **BC-119L** DESKTOP CHARGER

AD-89 BATTERY PACK ADAPTER attached to BC-119 DESKTOP CHARGER. (p. 7)

## ◇ Speaker-microphones

**HM-46**



**HM-54**

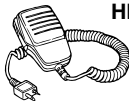

**HM-75A**



Remote control capability.  
(see p. 17 for details)

**HS-85** HEADSET



- PTT switch
- VOX
- One-touch PTT for hands-free operation

## ■ Channel number and group number

Use this page to record your group operating channel number (see p. 9) and group channel number (p. 11) for your reference.

<b>Operating channel number</b>	
<b>Group code number</b>	

## ◇ Channel frequency list

ch	Freq.(MHz)	ch	Freq.(MHz)	ch	Freq.(MHz)
1	433.075	24	433.650	47	434.225
2	433.100	25	433.675	48	434.250
3	433.125	26	433.700	49	434.275
4	433.150	27	433.725	50	434.300
5	433.175	28	433.750	51	434.325
6	433.200	29	433.775	52	434.350
7	433.225	30	433.800	53	434.375
8	433.250	31	433.825	54	434.400
9	433.275	32	433.850	55	434.425
10	433.300	33	433.875	56	434.450
11	433.325	34	433.900	57	434.475
12	433.350	35	433.925	58	434.500
13	433.375	36	433.950	59	434.525
14	433.400	37	433.975	60	434.550
15	433.425	38	434.000	61	434.575
16	433.450	39	434.025	62	434.600
17	433.475	40	434.050	63	434.625
18	433.500	41	434.075	64	434.650
19	433.525	42	434.100	65	434.675
20	433.550	43	434.125	66	434.700
21	433.575	44	434.150	67	434.725
22	433.600	45	434.175	68	434.750
23	433.625	46	434.200	69	434.775





## ABOUT CE

---



CE Versions of the IC-4008E which display the “CE” symbol on the serial number seal, comply with the essential requirements of the European Radio and Telecommunication Terminal Directive 1999/5/EC.

ⓘ This warning symbol indicates that this equipment operates in non-harmonised frequency bands and/or may be subject to licensing conditions in the country of use. Be sure to check that you have the correct version of this radio or the correct programming of this radio, to comply with national licensing requirement.



# DECLARATION OF CONFORMITY

We Icom Inc. Japan  
1-1-32, Kamiminami, Hirano-ku  
Osaka 547-0003, Japan

Declare on our sole responsibility that this equipment complies the essential requirements of the Radio and Telecommunications Terminal Equipment Directive, 1999/5/EC, and that any applicable Essential Test Suite measurements have been performed.

**Kind of equipment:** LPD FM TRANSCEIVER

**Type-designation:** IC-4008E

**Version (where applicable):**

This compliance is based on conformity with the following harmonized standards, specifications or documents:

- i) prETS 300 683 January 1997 (EMC product standard)
- ii) EN60950 August 1992 (Safety of information technology equipment)
- iii) I-ETS 300 220 October 1993 (Radio equipment for analog speech)
- iv) \_\_\_\_\_
- v) \_\_\_\_\_

**C E0560** !

Düsseldorf 10th Aug. 2000  
Place and date of issue

Icom (Europe) GmbH  
Himmelgeisterstraße 100  
D-40225 Düsseldorf

Authorized representative name

Icom (Europe) GmbH

  
T. Aoki  
General Manager  
Signature

Icom Inc.

Count on us!

< Intended Country of Use >

- |                           |                           |                           |
|---------------------------|---------------------------|---------------------------|
| <input type="radio"/> GER | <input type="radio"/> NED | <input type="radio"/> ITA |
| <input type="radio"/> AUT | <input type="radio"/> BEL | <input type="radio"/> GRE |
| <input type="radio"/> GBR | <input type="radio"/> LUX | <input type="radio"/> SWE |
| <input type="radio"/> IRL | <input type="radio"/> ESP | <input type="radio"/> DEN |
| <input type="radio"/> FRA | <input type="radio"/> POR | <input type="radio"/> FIN |