



## INSTRUCTION MANUAL

VHF MOBILE TRANSCEIVER

**IC-F1721/D**  
**IC-F1821/D**

UHF MOBILE TRANSCEIVER

**IC-F2721/D**  
**IC-F2821/D**

This device complies with Part 15 of the FCC Rules.  
Operation is subject to the condition that this device  
does not cause harmful interference.

Icom Inc.

**BIIS 1200**  
**Compatible**



This model is IC-F1821/D  
or IC-F2821/D

---

## IMPORTANT

---

**READ ALL INSTRUCTIONS** carefully and completely before using the transceiver.

**SAVE THIS INSTRUCTION MANUAL** — This instruction manual contains important operating instructions for the **IC-F1721/D, F1821/D, F2721/D and F2821/D VHF/UHF MOBILE TRANSCEIVERS**.

---

## EXPLICIT DEFINITIONS

---

WORD	DEFINITION
<b>⚠ WARNING</b>	Personal injury, fire hazard or electric shock may occur.
<b>CAUTION</b>	Equipment damage may occur.
<b>NOTE</b>	If disregarded, inconvenience only. No risk of personal injury, fire or electric shock.

Icom, Icom Inc. and the  ICOM logo are registered trademarks of Icom Incorporated (Japan) in the United States, the United Kingdom, Germany, France, Spain, Russia and/or other countries.

All other products or brands are registered trademarks or trademarks of their respective holders.

---

## PRECAUTION

---

**⚠ WARNING! NEVER** connect the transceiver to an AC outlet. This may pose a fire hazard or result in an electric shock.

**NEVER** connect the transceiver to a power source of more than 16 V DC such as a 24 V battery. This connection will ruin the transceiver.

**NEVER** cut the DC power cable between the DC plug and fuse holder. If an incorrect connection is made after cutting, the transceiver might be damaged.

**NEVER** place the transceiver where normal operation of the vehicle may be hindered or where it could cause bodily injury.

**NEVER** allow children to touch the transceiver.

**NEVER** expose the transceiver to rain, snow or any liquids.

**USE** the specified microphone only. Other microphones have different pin assignments and may damage the transceiver.

**DO NOT** use or place the transceiver in areas with temperatures below  $-30^{\circ}\text{C}$  ( $-22^{\circ}\text{F}$ ) or above  $+60^{\circ}\text{C}$  ( $+140^{\circ}\text{F}$ ), or in areas subject to direct sunlight, such as the dashboard.

---

## ABOUT APCO PROJECT 25

---

**AVOID** operating the transceiver without running the vehicle's engine. The vehicle's battery will quickly run out if the transceiver transmits while the vehicle's engine OFF.

**AVOID** placing the transceiver in excessively dusty environments.

**AVOID** placing the transceiver against walls. This will obstruct heat dissipation.

**AVOID** the use of chemical agents such as benzene or alcohol when cleaning, as they damage the transceiver surfaces.

**BE CAREFUL!** The transceiver will become hot when operating continuously for long periods.

*For U.S.A. only*

**CAUTION:** Changes or modifications to this transceiver, not expressly approved by Icom Inc., could void your authority to operate this transceiver under FCC regulations.

This device made under license under one or more of the following US patents: #4,590,473, #4,636,791, #5,148,482, #5,185,796, #5,271,017, #5,377,229.

The IMBE™ voice coding Technology embodied in this product is protected by intellectual property rights including patent rights, copyrights and trade secrets of Digital Voice Systems, Inc. This voice coding Technology is licensed solely for use within this Communications Equipment. The user of this Technology is explicitly prohibited from attempting to decompile, reverse engineer, or disassemble the Object Code, or in any other way convert the Object Code into a human-readable form. U.S. Pat. Nos. #5,870,405, #5,826,222, #5,754,974, #5,701,390, #5,715,365, #5,649,050, #5,630,011, #5,581,656, #5,517,511, #5,491,772, #5,247,579, #5,226,084, #5,195,166.

---

# TABLE OF CONTENTS

---

IMPORTANT .....	i	■ Receiving a message .....	18
EXPLICIT DEFINITIONS .....	i	◇ Receiving a status message .....	18
PRECAUTION .....	i	◇ Receiving an SDM (Short Data Message) .....	18
ABOUT APCO PROJECT 25 .....	ii	◇ Received message selection.....	19
TABLE OF CONTENTS .....	iii	■ Transmitting a status .....	20
<b>1 PANEL DESCRIPTION .....</b>	<b>1-7</b>	◇ General.....	20
■ Front panel .....	1	◇ Transmitting a status .....	20
■ Function display .....	2	■ Transmitting an SDM (Short Data Message) .....	21
■ Programmable function keys .....	3	◇ General.....	21
<b>2 BASIC OPERATION .....</b>	<b>8-13</b>	◇ Transmitting an SDM.....	21
■ Turning power ON .....	8	◇ Programming an SDM memory.....	22
■ Channel selection .....	8	■ Position data transmission .....	23
■ Call procedure .....	9	■ Printer connection .....	23
■ Receiving and transmitting .....	9	■ Digital ANI .....	23
◇ Transmitting notes.....	10	■ Auto emergency transmission .....	23
◇ TX code channel selection .....	10	■ Stun function .....	24
◇ TX code number edit.....	11	■ BIIIS indication .....	24
◇ Individual ID code selection.....	12	■ Priority A channel selection .....	24
◇ Talkgroup ID code selection .....	12	■ Horn output .....	24
◇ DTMF transmission .....	12	<b>4 CONNECTION AND MAINTENANCE .....</b>	<b>25-29</b>
■ User set mode .....	13	■ Rear panel connection .....	25
■ Scrambler function .....	13	■ Supplied Accessories .....	26
<b>3 BIIS OPERATION .....</b>	<b>14-24</b>	■ Mounting the transceiver .....	27
■ Default setting .....	14	■ Optional UT-111 installation .....	27
■ Receiving a call .....	14	■ Optional UT-109 or UT-110 installation .....	28
◇ Individual call.....	14	■ Optional OPC-617 installation .....	28
◇ Group call.....	15	■ Antenna.....	29
◇ Displaying the received call record.....	15	■ Fuse replacement .....	29
■ Transmitting a call .....	16	■ Cleaning .....	29
◇ Using call memory.....	16	■ Options .....	29
◇ Calling back from the queue channel.....	16	<b>5 SAFETY TRAINING INFORMATION .....</b>	<b>30</b>
◇ Direct code entry .....	17		

## ■ Front panel

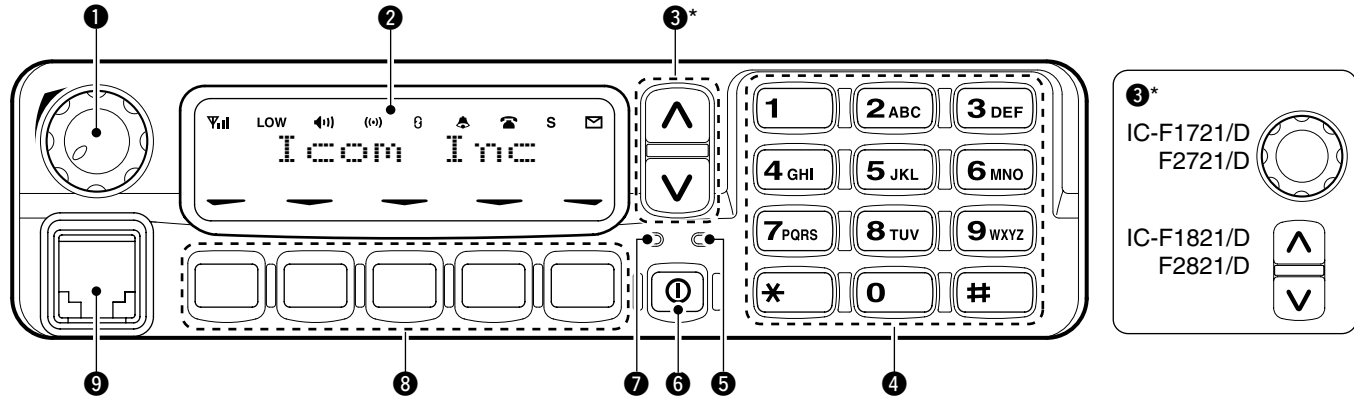

### 1 AF VOLUME CONTROL KNOB

- Rotate the knob to adjust the audio output level.
- Minimum audio level is pre-programmed.

### 2 FUNCTION DISPLAY (p. 2)

Displays a variety of information, such as an operating channel number/name, 5-tone code, DTMF numbers and audible condition, etc.

### 3 DIAL or UP/DOWN KEYS

- IC-F1721/D, F2721/D: **DIAL**  
Rotate to select an operating channel, etc.
- IC-F1821/D, F2821/D: **UP/DOWN Keys**  
Push to select an operating channel, etc.

\*The desired function can be assigned by your dealer. (p. 3)

### 4 10-KEYPAD (IC-F1821/D or IC-F2821/D only)

The keypad allows you to enter digits to:

- Select memory channels, tone channels and DTMF codes (when in the DTMF code channel selection mode)
- Set TX codes and BIIS status number
- Input text message for SDM operation
- Start up with a password
- Input the Individual ID code for digital operation.

### 5 BUSY INDICATOR

Lights green while receiving a signal, or when the squelch is open.

# 1 PANEL DESCRIPTION

## 6 POWER SWITCH [POWER]

Push to turn the power ON and OFF.

- The following functions are available at power ON as options:
  - Automatic scan start
  - Password prompt
  - Set mode

## 7 TRANSMIT INDICATOR

Lights red while transmitting.

## 8 DEALER-PROGRAMMABLE KEYS

Desired functions can be programmed independently by your dealer. (p. 3)

▨ In this instruction manual, these keys are from the left, called [P0]/[P1]/[P2]/[P3]/[P4].

## 9 MICROPHONE CONNECTOR

Connect the supplied microphone or optional DTMF microphone.

▨ **NEVER** connect non-specified microphones. The pin assignments may be different and the transceiver may be damaged.

## ◇ MICROPHONE

The supplied microphone has a PTT switch and a hanger hook.

- The following functions are available when the microphone is on or off hook:
  - Automatic scan start when on hook.
  - Automatic priority channel selection when off hook.
  - Sets to 'Inaudible' condition (mute condition) when on hook.
  - Sets to 'Audible' condition (unmute condition) when off hook.

## ■ Function display

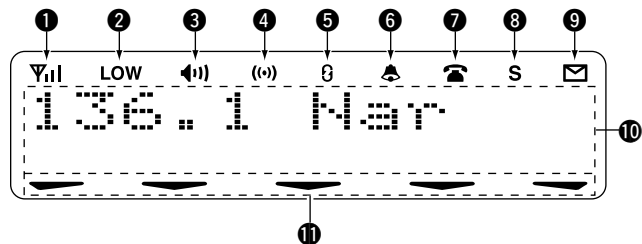

## 1 SIGNAL STRENGTH INDICATOR

Indicates relative signal strength level.

## 2 LOW POWER INDICATOR

Appears when low output power is selected.

## 3 AUDIBLE INDICATOR

➔ Appears when the channel is in the 'audible' (unmute) condition.

➔ Appears when the specified 2/5-tone/BIIS code is received.

## 4 COMPANDER INDICATOR

Appears when the compander function is activated.

## 5 SCRAMBLER INDICATOR

Appears when the voice scrambler function is activated.

**6 BELL INDICATOR**

Appears/blinks when the specific 2/5-tone/BIIS code is received, according to the pre-programming.

**7 CALL CODE MEMORY INDICATOR**

Appears when the call code memory is selected.

**8 SCROLL INDICATOR**

Appears when a received SDM including more than 12 characters is displayed.

**9 SDM INDICATOR**

Appears when an SDM is received, or a transmit SDM is selected.

**10 ALPHANUMERIC DISPLAY**

Displays an operating channel number, channel name, Set mode contents, DTMF code, etc.

The indication mode can be selected from 1 line or 2 lines. Ask your dealer for details.

In this instruction manual, the LCD illustration is described using the 2 lines indication mode.

**11 ACTIVATED KEY INDICATOR**

Appears above the key assigned as [DIGITAL] key when that key has been activated.

**■ Programmable function keys**

The following functions can be assigned to [DIAL]\*, [UP], [DOWN], [P0], [P1], [P2], [P3] and [P4] programmable function keys.

Consult your Icom dealer or system operator for details concerning your transceivers programming.

If the programmable function names are bracketed in the following explanations, the specific key is used to activate the function depends on the programming.

\*The functions you can assign to [DIAL] are limited.

(Only functions marked with ☆ can be assigned.)

**☆ CH UP AND DOWN KEYS**

- Push (or Rotate)\* to select an operating channel.
  - Push (or Rotate)\* to select a transmit code channel after pushing [TX Code CH Select].
  - Push (or Rotate)\* to select a DTMF channel after pushing [DTMF Autodial].
  - Push (or Rotate)\* to select a scan group after pushing and holding [Scan A Start/Stop]/[Scan B Start/Stop].
  - Push (or Rotate)\* to select a BIIS code, status number or SDM after pushing [Digital].
  - Push (or Rotate)\* to select an Individual ID code or Talkgroup ID code after pushing [Individual] or [Talkgroup].
- \*Rotate when this function is assigned to [DIAL].

☆ **ZONE UP AND DOWN KEY** (This function is for [DIAL] only)  
Rotate to select the desired zone.

---

# 1 PANEL DESCRIPTION

## **ZONE SELECT KEY**

Push this key, then select the desired zone using [CH Up]/[CH Down].

 **What is “zone”?**— The desired channels are assigned into a zone according to the intended use. For example, ‘Staff A’ and ‘Staff B’ are assigned into a “Business” zone, and ‘John’ and ‘Cindy’ are assigned into a “Private” zone.

## **SCAN A KEY**

➔ This key’s operation depends on the Power ON Scan setting.

### **When the power ON scan function is turned OFF;**

Push to start and cancel scanning operation. In case of transmission during scan, cancels scanning.

### **When the power ON scan function is turned ON;**

Push to pause scanning. Scanning resumes after a specified time period has passed. In case of transmission during scan, pauses scanning. Scanning resumes after a specified time period has passed after the transmission is finished.

➔ Push and hold this key for 1 sec. to indicate the scan group, then select the desired group using [CH Up]/[CH Down].

## **SCAN B KEY**

➔ Push to start and cancel scanning operation. In case of transmission during scan, pauses scanning. Scanning resumes after a specified time period has passed after the transmission is finished.

➔ Push and hold this key for 1 sec. to indicate the scan group, then select the desired group using [CH Up]/[CH Down].

## **SCAN TAG KEY**

Push to add or delete the selected channel to/from the scan group.

## **PRIORITY CHANNEL KEYS**

➔ Push to select Priority A or Priority B channel.

➔ Push and hold [Prio A (Rewrite)] to rewrite the Prio A channel.

## **MR-CH 1/2/3/4 KEYS**

Push to select an operating channel directly.

## **MONITOR KEY**

➔ Mute and release the CTCSS (DTCS) or 2-tone squelch mute. Open any squelch/deactivate any mute while pushing this key. (LMR operation only)

➔ Activates one of (or two of) the following functions on each channel independently: (PMR or BISS PMR operation only)

- Push and hold to un-mute the channel (audio is emitted; ‘Audible’ condition).
- Push to mute the channel (sets to ‘Inaudible’ only).
- Push to un-mute the channel (sets to ‘Audible’ only).
- Push after the communication is finished to send a ‘reset code’.

 **NOTE:** The un-mute condition (‘Audible’ condition) may automatically return to the mute condition (‘Inaudible’ condition) after a specified period depending on programming.



**PUBLIC ADDRESS KEY**

While in the hailer mode, push this key for the audio output via the hailer amplifier. Ask your dealer for details.

While in the normal mode, the audio output via the cable can be controlled from the transceiver separately from [VOL] control knob when an optional OPC-617 ACC CABLE is installed.

- This audio output can be used as a 'public address' function when an external audio amplifier and speaker are connected additionally.
- Push this key, then speak into the microphone while pushing the PTT switch.
- [CH Up]/[CH Down] allow you to set the audio output level from minimum to maximum.

**RX SPEAKER KEY**

While in the hailer mode, the external speaker drive function is also available simultaneously when the external connections are made for the 'public address' function. The received audio can be heard via the external speaker when this key is pushed.

- This function is useful when you are out of the vehicle.
- The audio output level is linked to the transceiver's volume control.

**LIGHT KEY**

Push to turn the transceiver's backlight ON temporarily when the backlight function is turned OFF in user set mode.

**LOCK KEY**

Push and hold to electronically lock all programmable keys except the following:

[Call] (incl. Call A and Call B), [Moni(Audi)] and [Emergency].

**OUTPUT POWER SELECTION KEY**

Push to select the transmit output power temporarily or permanently, depending on the pre-setting.

- Ask your dealer for the output power level for each selection.

**C.TONE CHANNEL ENTER KEY**

Push to select the continuous tone channel using [CH Up]/[CH Down] to change the tone frequency/code setting after pushing this key. The selected channel remains set as the continuous tone channel until another channel is designated as such.

**TALK AROUND KEY**

Turn the talk around function ON and OFF.

- The talk around function equalizes the transmit frequency to the receive frequency for transceiver-to-transceiver communication.

**WIDE/NARROW KEY**

Push to toggle the IF bandwidth between wide and narrow.

- The wide passband width can be selected from 25.0 or 20.0 kHz using the CS-F1700 CLONING SOFTWARE. (PMR or BIIS PMR operation only) Ask your Dealer for details.

**DTMF AUTODIAL KEY**

- ➔ Push to enter the DTMF channel selection mode. Then select the desired DTMF channel using [CH Up]/[CH Down].
- ➔ After selecting the desired DTMF channel, push this key to transmit the DTMF code.

# 1 PANEL DESCRIPTION

## **DTMF RE-DIAL KEY**

Push to transmit the last-transmitted DTMF code.

## **CALL KEYS**

Push to transmit a 2/5-tone/BIIS ID code.

- Call transmission is necessary before calling another station depending on your signalling system.
- [Call A] and/or [Call B] may be available when your system employs selective 'Individual/Group' calls. Ask your dealer which call is assigned to each key.

## **EMERGENCY KEYS**

- ➔ Push and hold to transmit an emergency call.
- ➔ When [Emergency Single (Silent)] or [Emergency Repeat (Silent)] is pushed, an emergency call is transmitted without a beep emission and LCD indication change.
  - If you want to cancel the emergency call, push (or push and hold) the key again before transmitting the call.
  - The emergency call is transmitted one time only or repeatedly until receiving a control code depending on the pre-setting.

## **TX CODE ENTER KEY** (PMR or BIIS PMR operation only)

Push to enter the ID code edit mode directly, for both 5-tone and MSK. Then set the desired digit using [CH Up]/[CH Down] or 10-keypad\*. (p. 11)

\*IC-F1821/D or IC-F2821/D only

## **TX CODE CHANNEL SELECT KEY**

- ➔ Push to enter the ID code channel selection mode directly. Then set the desired channel using [CH Up]/[CH Down]. (p. 10)
- ➔ During ID code channel selection mode, push for 1 sec. to enter the ID code edit mode for 5-tone and MSK. Then set the desired digit using [CH Up]/[CH Down] or 10-keypad\*. (p. 11)
  - \*IC-F1821/D or IC-F2821/D only

## ☆ **TX CODE CHANNEL UP/DOWN KEYS**

Push (or Rotate)\* to select a TX code channel directly.  
\*Rotate when this function is assigned to [DIAL].

## **ID MEMORY READ KEY** (PMR or BIIS PMR operation only)

- ➔ Recalls detected ID codes.
  - Push this key, then select the ID code using [CH Up]/[CH Down].
  - Up to 5 ID's are memorized.
- ➔ Push and hold to erase the selected ID's.

## **VOICE SCRAMBLER FUNCTION**

Push to toggle the voice scrambler function ON and OFF.

## **COMPANDER KEY**

Push to toggle the compander function ON and OFF. The compander function reduces noise components from the transmitted audio to provide clear communication.

**USER SET MODE KEY**

- Push and hold to enter user set mode.
  - During user set mode, push this key to select an item, and change the value or condition using push [CH Up]/[CH Down].

- Push and hold this key again to exit user set mode.

User set mode is also available via the 'Power ON function.' Refer to p. 13 also.

**OPT OUT KEYS**

Push to control the output signal level from the optional unit connector.

**DIGITAL KEY** (BIIS operation only)

- Push to select the call ID list, transmit message and standby condition. Toggles between queue channel and received message record indication after queue channel is selected.
- Push and hold to select queue channel indication.

☆ **STATUS UP/DOWN KEYS** (BIIS operation only)

- While in the standby condition, push (or rotate)\* to display the transmit status indication and select a status number.
- When a received SDM is displayed, push (or rotate)\* to cancel the automatic scroll and scroll the message manually.
- When an SDM that contains more than 12 characters is displayed, push (or rotate)\* to scroll the message manually.

\*Rotate when this function is assigned to [DIAL].

◇ **For Digital mode operation only****INDIVIDUAL KEY**

- Push to enter the individual ID code selection mode directly. Then select the desired individual ID code using [CH Up]/[CH Down]. (p. 12)
- Push to stop the beep emission when receiving a matched individual ID code.

**TALKGROUP KEY**

- Push to enter the talkgroup ID code selection mode directly. Then select the desired talkgroup ID code using [CH Up]/[CH Down]. (p. 12)
- Push to stop the beep emission when receiving a matched talkgroup ID code.

## ■ Turning power ON

- ① Push [  ] to turn the power ON.
- ② If the transceiver is programmed for a start up password, input the digit codes as directed by your dealer.
  - 10-keypad\* can be used for password input.
    - \*IC-F1821/D or IC-F2821/D only:
  - The keys as below can be used for password input:  
The transceiver detects numbers in the same block as identical. Therefore “01234” and “56789” are the same.

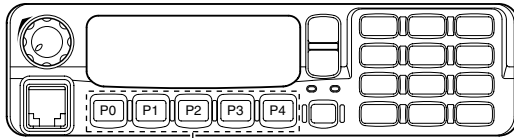

\*In this instruction manual, these keys are from the left, called [P0]/[P1]/[P2]/[P3]/[P4].

KEY	P0	P1	P2	P3	P4
NUMBER	0	1	2	3	4
	5	6	7	8	9

- ③ When the “PASSWORD” indication does not clear after inputting 6 digits, the input code number may be incorrect. Turn the power off and start over in this case.

## ■ Channel selection

Several types of channel selections are available. Methods may differ according to your system set up.

### **NON-ZONE TYPE:**

Push [CH Up] or [CH Down], or rotate [CH Up/Down] to select the desired operating channel, in sequence; or, push one of [MR-CH 1] to [MR-CH 4] keys to select a channel directly.

### **ZONE TYPE:**

Push [Zone] then push [CH Up] or [CH Down], or rotate [Zone Up/Down] to select the desired zone.

### **AUTOMATIC SCAN TYPE:**

Channel setting is not necessary for this type. When turning power ON, the transceiver automatically starts scanning. Scanning stops when receiving a call.

## Call procedure

When your system employs tone signaling (excluding CTCSS and DTCS), the call procedure may be necessary prior to voice transmission. The tone signalling employed may be a selective calling system which allows you to call specific station(s) only and prevent unwanted stations from contacting you.

- ① Select the desired TX code channel, 2/5-tone code, Individual ID code\* or Talkgroup ID code\* according to your System Operator's instructions.
  - This may not be necessary depending on programming.
  - Refer to pgs. 10–12 for selection.
- \*Digital mode operation only.
- ② Push the call key (assigned to one of the dealer programmable keys; except for the Digital mode operation) or [PTT].
- ③ After transmitting, the remainder of your communication can be carried out in the normal fashion.

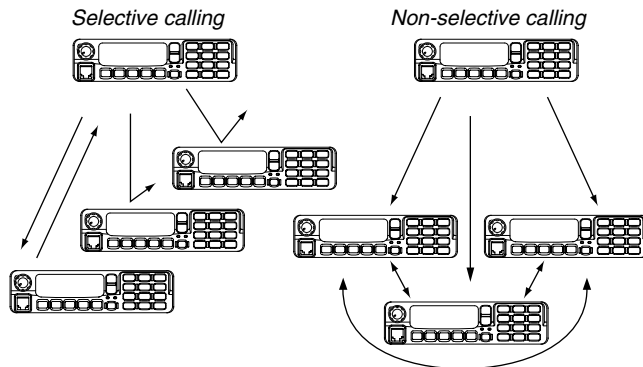

## Receiving and transmitting

### Receiving:

- ① Push [⏻] to turn the power ON.
- ② Push [CH Up] or [CH Down], or rotate [CH Up/Down] to select a channel, in sequence.
- ③ When receiving a call, adjust the audio output level to a comfortable listening level.

### Transmitting:

Wait for the channel to become clear to avoid interference.

- ① Take the microphone off hook.
  - 2-tone, 5-tone mute may be released. (The 'audible' condition is selected and BUSY indicator lights green.)
  - A priority channel may be selected automatically.
- ② Wait for the channel to become clear.
  - The channel is busy when BUSY indicator lights green.
- ③ Push [CALL] when initiating a call from your side.
  - Coded audio may be heard from the transceiver, then “◀▶” appears.
  - This operation may not be necessary depending on your signaling system. Ask your dealer for details.
- ④ While pushing and holding [PTT], speak into the microphone at your normal voice level.
- ⑤ Release [PTT] to receive.

- IMPORTANT:** To maximize the readability of your signal;
1. Pause briefly after pushing [PTT].
  2. Hold the microphone 5 to 10 cm (2 to 4 inches) from your mouth, then speak into the microphone at a normal voice level.

---

## 2 BASIC OPERATION

### ◇ Transmitting notes

#### • Transmit inhibit function

The transceiver has several inhibit functions which restrict transmission under the following conditions:

- The channel is in mute condition ('Inaudible' condition; "🔇" does not appear.)
  - The channel is busy.
  - Un-matched (or matched) CTCSS is received.
  - Un-matched (or matched) NAC is received.\*
  - Un-matched (or matched) Individual ID or Talkgroup ID is received.\*
  - The selected channel is a 'receive only' channel.
- \*Digital mode operation only.

#### • Time-out timer

After continuous transmission for the pre-programmed time period, the time-out timer is activated, causing the transceiver to stop transmitting.

#### • Penalty timer

Once the time-out timer is activated, transmission is further inhibited for a period determined by the penalty timer.

### ◇ TX code channel selection

If the transceiver has [TX Code CH Select] assigned to it, the indication can be toggled between the operating channel number (or name) and TX code channel number (or name). When the TX code channel number (or name) is displayed, [CH Up]/[CH Down] selects the TX code channel.

#### **USING [TX CODE CH SELECT] KEY:**

- ① Push [TX Code CH Select]— a TX code channel number (or name) appears.
- ② Push [CH Up] or [CH Down], or rotate [CH Up/Down] to select the desired TX code channel.
- ③ Push [Call] (or [PTT] during MSK operation) to transmit the selected TX code.

#### **USING [TX CODE CH UP]/[TX CODE CH DOWN] KEY:**

If the transceiver has a [TX Code CH Up], [TX Code CH Down] or [TX Code CH Up/Down] key assignment, the programmed TX code channel can be selected directly when pushed or rotated.

#### **NOTE for PMR or BIIS PMR operation:**

- The LCD indication does not change when the operating channel number (or name) is displayed.
- To check the selected TX code, push [TX Code CH Select].

**◇ TX code number edit**

(PMR or BIIS PMR operation only)

If the transceiver has [TX Code CH Select] or [TX Code Enter] assigned to it, TX code contents can be edited within the allowable digits.

**USING [TX CODE CH SELECT] KEY:**

- ① Push [TX Code CH Select] to enter the TX code channel selection mode.
  - Select the desired channel before entering the TX code channel selection mode if necessary.
- ② Push [TX Code CH Select] for 1 sec. to enter the TX code edit mode.
- ③ Push [TX Code CH Select] to select the desired digit to be edited.
  - The digit to be edited blinks.
- ④ Push [CH Up], [CH Down] or 10-keypad\*, or rotate [CH Up/Down] to set the desired digit.
- ⑤ Push [TX Code CH Select] to set the digit. The digit to the right will blink automatically.
  - When the 10-keypad\* is used for setting, the digit to the right will blink automatically without pushing [TX Code CH Select].
- ⑥ Repeat ④ and ⑤ to input all allowable digits.
- ⑦ Push [Call] or [PTT] to transmit the edited TX code.

\*IC-F1821/D or IC-F2821/D only

**USING [TX CODE ENTER] KEY:**

- ① Select the desired TX code channel via [TX Code CH Select]+[CH Up] or [CH Down], [TX Code CH Up], [TX Code CH Down] or [TX Code CH Up/Down].
- ② Push [TX Code Enter] to enter the TX code edit mode.
- ③ Push [TX Code Enter] to select the desired digit to be edited.
  - The digit to be edited blinks.
- ④ Push [CH Up], [CH Down] or 10-keypad\*, or rotate [CH Up/Down] to set the desired digit .
- ⑤ Push [TX Code Enter] to set the digit. The digit to the right will blink automatically.
  - When the 10-keypad\* is used for setting, the digit to the right will blink automatically without pushing [TX Code CH Select].
- ⑥ Repeat ④ and ⑤ to input all allowable digits.
- ⑦ Push [Call] or [PTT] to transmit the edited TX code.

\*IC-F1821/D or IC-F2821/D only

---

## 2 BASIC OPERATION

### ◇ Individual ID code selection

(Digital mode operation only)

If the transceiver has [Individual] assigned to it, the indication can be toggled between the operating channel number (or name) and Individual ID code (or name). When the Individual ID code (or name) is displayed, [CH Up], [CH Down] or [CH Up/Down] selects the desired Individual ID code.

- ① Push [Individual]— an Individual ID code (or name) appears.
- ② Push [CH Up] or [CH Down], or rotate [CH Up/Down] to select the desired Individual ID code.
- ③ Push [PTT] to transmit the selected Individual ID code.
- ④ Push [Individual]— cancels the selected Individual ID code (return to the pre-set Talkgroup ID code in the channel.)

### ◇ Talkgroup ID code selection

(Digital mode operation only)

If the transceiver has [Talkgroup] assigned to it, the indication can be toggled between the operating channel number (or name) and Talkgroup ID code (or name). When the Talkgroup ID code (or name) is displayed, [CH Up], [CH Down] or [CH Up/Down] selects the desired Talkgroup ID code.

- ① Push [Talkgroup]— a Talkgroup ID code (or name) appears.
- ② Push [CH Up] or [CH Down], or rotate [CH Up/Down] to select the desired Talkgroup ID code.
- ③ Push [PTT] to transmit the selected Talkgroup ID code.

- ④ Change the channel— cancels the selected Talkgroup ID code (return to the pre-set Talkgroup ID code in the channel.)

### ◇ DTMF transmission

If the transceiver has [DTMF Autodial] assigned to it, the automatic DTMF transmission function is available. Up to 8 DTMF channels are available.

#### TO SELECT A TX CODE:

- ① Push [DTMF Autodial]— a DTMF channel appears.
- ② Push [CH Up] or [CH Down], or rotate [CH Up/Down] to select the desired DTMF channel.
- ③ Push [DTMF Autodial] to transmit the DTMF code in the selected DTMF channel.



## ■ User set mode

User set mode is accessed with [User Set Mode] and allows you to set seldom-changed settings. In this case you can “customize” the transceiver operation to suit your preferences and operating style.

### Entering the user set mode:

- ① While pushing and holding [P1] and [P2], push [D] to turn the power ON. Then, push and hold [P0] to enter user set mode.

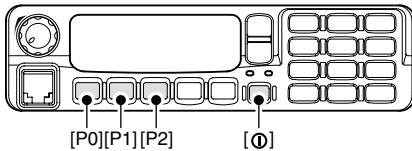

- ② Push [P0] several times to select the appropriate item. Then, push [Up] or [Down] or rotate [DIAL] to set the desired level/condition.

- Available set mode functions are **Backlight**, **LCD Contrast**, **Beep**, **Beep Level**, **SQL Level**, **AF Min Level**, **Mic Gain** and **Horn**.

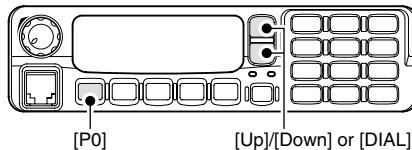

- ③ Push [D] again to exit set mode.

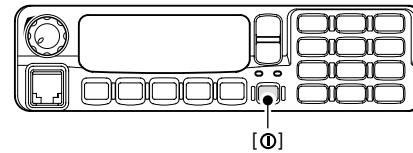

User set mode is also available via a programmable key. Please refer to p. 7 [User Set Mode] section.

## ■ Scrambler function

The voice scrambler function provides private communication between stations. The frequency inversion type is equipped to all versions, moreover, the optional Rolling or Non-rolling type can be available.

- ① Push [Scrambler] to turn the scrambler function ON.
  - “g” appears.
- ② Push [Scrambler] again to turn the scrambler function OFF.
  - “g” disappears.

## ■ Default setting

The following functions are assigned to each programmable key as the default. However, the assigned function can be changed by your dealer. Ask your dealer for details.

During digital mode operation, BIIS is not available.

/// **NOTE:** [TX Code Enter] must be assigned to a key.

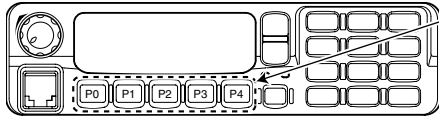



In this instruction manual, these keys are from the left, called [P0]/[P1]/[P2]/[P3]/[P4].

- [P0]; Call : Push to transmit a 5-tone/BIIS call when the selected channel is a 5-tone or MSK channel.
- [P1]; Digital : Push to select the call list ID/transmit message, or to display the receive message record for selection.
- [P3]; TX Code Enter : Push to enter the ID code edit mode directly for both 5-tone and MSK.
- [P4]; Moni(Audi) : Push this key after the communication to send a 'Clear down' signal during MSK channel operation.
- [P2]; Null : No function is assigned.
- [Up]/[Down]/[DIAL]; CH Up/Down : While in the standby condition, selects the operating channel. After pushing [Digital] or [TX Code CH Select], selects call list or TX code channel, respectively.

## ■ Receiving a call

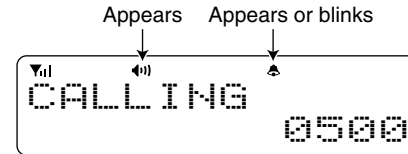

### ◆ Individual call

- ① When an individual call is received;
  - Beeps sound.
  - “” appears and the mute is released.
  - The programmed text message (e.g.“CALLING”) and the calling station ID (or text) is displayed when the indication mode is 2 lines.
  - The programmed text message (e.g.“CALLING”) and the calling station ID (or text) is displayed alternately when the indication mode is 1 line, depending on the setting.
  - “” appears or blinks depending on the setting.



- ② Push and hold [PTT], then speak into the microphone at a normal voice level.
  - TX indicator lights red.
- ③ Release [PTT] to return to receive.
  - BUSY indicator lights green while receiving a signal.
- ④ To finish the conversation, push [P4] (Moni(Audi)) to send the 'Clear down' signal.
  - Either station can send a 'Clear down' signal.
  - “CLR DOWN” is displayed for 2 sec. (approx.).
  - “” disappears and the transceiver returns to the standby condition.

### ◆ Group call

- ① When a group call is received;
  - Beeps sound.
  - “” appears and the mute is released.
  - The programmed text message (e.g. “GROUP”) and the calling station ID (or text) is displayed when the indication mode is 2 lines.
  - The programmed text message (e.g. “GROUP”) and the calling station ID (or text) is displayed alternately when the indication mode is 1 line, depending on the setting.
  - “” appears or blinks depending on the setting.

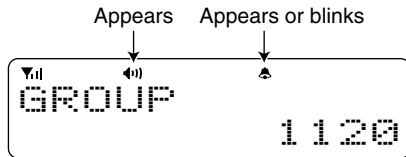

- ② Push and hold [PTT], then speak into the microphone at a normal voice level.
  - TX indicator lights red.
  - /// **NOTE:** Only one station is permitted to speak.
- ③ Release [PTT] to return to receive.
  - BUSY indicator lights green while receiving a signal.
- ④ To finish the conversation, push [MONITOR] (Moni(Audi)) to send the ‘Clear down’ signal.
  - Either station can send a ‘Clear down’ signal.
  - “CLR DOWN” is displayed for 2 sec. (approx.)
  - “” disappears and the transceiver returns to the standby condition.

### ◆ Displaying the received call record — Queue indication

The transceiver memorizes the calling station ID in the memory. Up to 3 calls can be memorized, and the oldest call record is erased when a 4th call is received. However, once the transceiver is powered OFF, the all records are cleared.

- ① Push [P1] (Digital) for 1 sec.
  - Displays following indication.

#### *When a record is available*

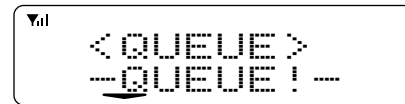

#### *When no record is available*

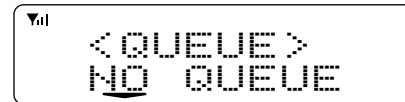

- ② Push [Up] or [Down], or rotate [DIAL] to select the desired call.
- ③ Push [P1] (Digital) for 1 sec. again to return to the standby condition.
  - When no operation is performed for 30 sec., the transceiver returns to the standby condition automatically.

## 3 BIIS OPERATION

### ■ Transmitting a call

A total of 3 ways for code selection are available—selecting the call code from memory, entering the call code from the keypad and calling back from the queue channel record.

#### ◇ Using call memory

- ① While in the standby condition, push [P1] (Digital) to enter the call code memory channel selection mode.  
•“☎” appears.

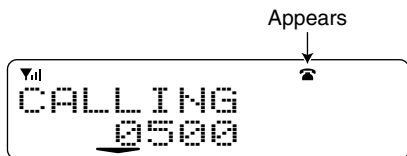

- ② Push [Up] or [Down], or rotate [DIAL] to select the desired call code.
- ③ Push [P0] (Call) or [PTT]\* to call.  
\*PTT call can be made only when PTT call capability is permitted.

**NOTE:** When no answer back is received, the transceiver repeats the call 3 times (default) automatically, and “WAIT” is displayed during each call. However, an error beep sounds and “FAILED” is displayed when no answer back is received after the calls.

- ④ Push [PTT] to transmit; release to receive.
- ⑤ Push [P4] (Moni(Audi)) to send the ‘Clear down’ signal.

#### ◇ Calling back from the queue channel

- ① While in the standby condition, push [P1] (Digital) for 1 sec. to enter the queue memory channel selection mode.
- ② Push [Up] or [Down] or rotate [DIAL] to select the desired record.

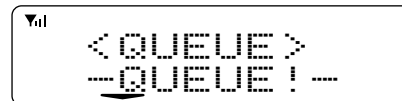

- ③ Push [P0] (Call) or [PTT]\* to call.  
\*PTT call can be made only when PTT call capability is permitted.
- NOTE:** When no answer back is received, the transceiver repeats the call 3 times (default) automatically, and “WAIT” is displayed during each call. However, an error beep sounds and “FAILED” is displayed when no answer back is received after the calls.
- ④ Push [PTT] to transmit; release to receive.
  - ⑤ Push [P4] (Moni(Audi)) to send the ‘Clear down’ signal.

### ◆ Direct code entry

- ① While in the standby condition, push [P3] (TX Code Enter) to enter the TX code edit mode.
  - Code digit for editing blinks.

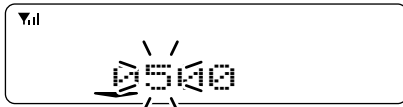

- ② Push [P3] (TX Code Enter) to select the desired digit to be edited.
  - Digit for editing differs according to the setting.
- ③ Set the desired digit using [CH Up]/[CH Down]/[DIAL] or 10-keypad\*.
  - \*IC-F1821/D or IC-F2821/D only
- ④ Push [P3] (TX Code Enter) to set the digit, then the digit to the right will blink automatically.
  - When the 10-keypad is used for setting, the digit to the right will blink automatically without pushing [P3] (TX Code Enter).
- ⑤ Repeat ③ and ④ to input all allowable digits.
- ⑥ Push [P0] (Call) or [PTT]\* to call.
  - \*PTT call can be made only when PTT call capability is permitted.

/// **NOTE:** When no answer back is received, the transceiver repeats the call 3 times (default) automatically, and "WAIT" is displayed during each call. However, an error beep sounds and "FAILED" is displayed when no answer back is received after the calls.

- ⑦ Push [PTT] to transmit; release to receive.
- ⑧ Push [P4] (Moni(Audi)) to send the 'Clear down' signal.

### *For your information*

When the "UpDate" setting for the call code is enabled, the set code is overwritten into the call code memory.

### 3 BIIS OPERATION

## ■ Receiving a message

### ◆ Receiving a status message

- ① When a status message is received;
  - Beeps sound.
  - The calling station ID (or text) and the status message is displayed alternately when the indication mode is 1 line, depending on the setting.

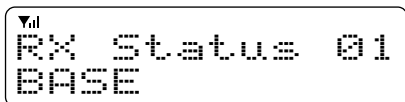

- ② Push [P4] (Moni(Audi)) to return to the standby condition.

**NOTE:** Only the calling station ID (or text) is displayed (no message is displayed alternately) when the scroll timer is set to 'OFF.' In this case, push [Status Up]/[Status Down] to display the status message manually.

### ◆ Receiving an SDM (Short Data Message)

- ① When an SDM is received;
  - Beeps sound.
  - The calling station ID (or text) and the SDM is displayed alternately when the indication mode is 1 line, depending on the setting.
  - “✉” appears

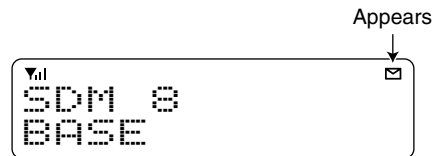

- ② When the received SDM includes more than 12 characters, “S” appears and the message scrolls automatically, when the automatic scroll function is activated.
  - Push [Status Up]/[Status Down] to scroll the message manually.

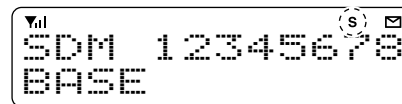

- ③ Push [P4] (Moni(Audi)) to return to the standby condition.

### ◇ Received message selection

The transceiver memorizes the received message in the memory. Up to 6 messages for status and SDM, or 95 character SDM's can be memorized. The oldest message is erased when the 7th message is received. However, once the transceiver is powered OFF, all messages are cleared.

- ① Push [P1] (Digital) for 1 sec.
  - Displays queue memory.
- ② Push [P1] (Digital) momentarily.
  - Displays message memory.

#### *When a message is available*

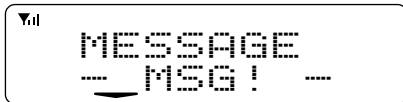

#### *When no message is available*

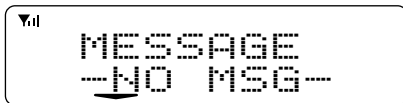

- ③ Push [Up] or [Down], or rotate [DIAL] to select the desired message.
  - When selecting the SDM that includes more than 12 characters, "S" appears and the message scrolls automatically when the automatic scroll function is activated.
  - Push [Status Up]/[Status Down] to scroll the message manually.

- ④ Push [P1] (Digital) for 1 sec. again to return to the standby condition.
  - When no operation is performed for 30 sec., the transceiver returns to the standby condition automatically.

## 3 BIIS OPERATION

### ■ Transmitting a status

#### ◇ General

The status message can be selected with the programmed text, and the message text is also displayed on the function display of the called station.

Up to 24 status types (1 to 24) are available, and the status messages 22 and 24 have designated meanings.

Status 22: Emergency\*

Status 24: GPS request

\*The status 22 can also be used as a normal status message by disabling the designated meaning. However, the status 24 is fixed.

The status call can be sent with both individual and group calls.

#### ◇ Transmitting a status

- ① While in the standby condition, push [P1] (Digital), then push [Up] or [Down], or rotate [DIAL] to select the desired station/group code.
- ② Push [P1] (Digital) again, then push [UP] or [DOWN] to select the desired status message.

Or, you can select the desired status message using [Status Up]/[Status Down] key directly.

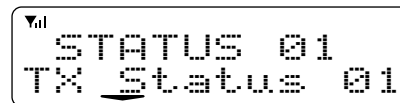

Status message is displayed.

- ③ Push [P0] (Call) or [PTT]\* to transmit the status message to the selected station/group.
  - \*PTT call can be made only when PTT call capability is permitted.
  - 2 beeps will sound and the transceiver returns to the standby condition automatically when the transmission is successful.



## ■ Transmitting an SDM (Short Data Message)

### ◇ General

The short data message, SDM, can be sent to an individual station or group stations. Also, 8 SDM memory channels are available and the messages can be edited via PC programming.

### ◇ Transmitting an SDM

- ① While in the standby condition, push [P1] (Digital), then push [Up] or [Down] or rotate [DIAL] to select the desired station/group code.
- ② Push [P1] (Digital) again, then push [Up] or [Down] or rotate [DIAL] to select the desired SDM.

Or, you can select the desired SDM using [Status Up]/[Status Down] key directly.

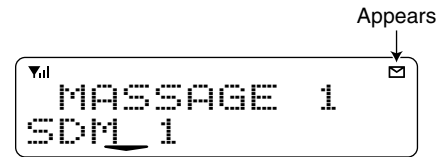

SDM is displayed.

- ③ Push [P0] (Call) or [PTT]\* to transmit the SDM to the selected station/group.
  - \*PTT call can be made only when PTT call capability is permitted.
  - 2 beeps will sound and the transceiver returns to the standby condition automatically when the transmission is successful.

### 3 BIIS OPERATION

#### ◆ Programming an SDM memory

(IC-F1821/D or IC-F2821/D only)

- ① During standby condition, push [P1] (Digital) twice, then push [Up] or [Down] to select the desired SDM to be edited.
- ② Push [\*] or [#] to enter the message editing condition.
  - The first character blinks when [#] is pushed, the last character blinks when [\*] is pushed.
  - “” blinks.

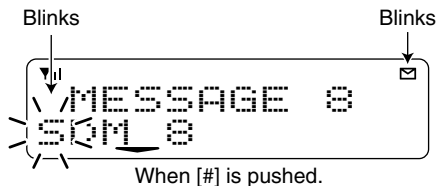

- ③ Push the appropriate digit key, [0] to [9], to enter the desired character.
  - See the table at right for the available characters.
  - Pushing [UP] also enters space, pushing [DOWN] deletes the selected character.
- ④ Push [#] to move the cursor to the right, push [\*] to move the cursor to the left.
- ⑤ Repeat steps ③ and ④ to set the desired text message.
- ⑥ Push [P1] (Digital) for 1 sec. to overwrite the set content into the memory.
  - Push [P1] (Digital) momentarily to cancel the editing and return to the original message indication.

#### • Available characters

Key	Characters
[0]	0 1 ! ? ' " , ; : _ ( ) < > [ ]
[1]	1 (sPace) # * / + - = \ & % \$ @ ^
[2]	2 A B C a b c
[3]	3 D E F d e f
[4]	4 G H I g h i
[5]	5 J K L j k l
[6]	6 M N O m n o
[7]	7 P Q R S p q r s
[8]	8 T U V t u v
[9]	9 W X Y Z w x y z

**NOTE:** A decimal point can only be written with the CS-F1700 CLONING SOFTWARE. Pre-programmed characters can be rewritten with the 10-keypad, except for the decimal point, as it is not included in the transceiver character list, and cannot be displayed again.

## ■ Position data transmission

When the optional cable and a GPS receiver is connected to the transceiver, the position (longitude and latitude) data can be transmitted automatically.

Ask your dealer or system operator for connection details.

The position data is transmitted when;

- Status 24 message is received
  - \*When the status 24 message, GPS request, is received.
- Fully automatic
  - When automatic position transmission is enabled, send the position data according to 'Time Marker' and 'Interval Timer' settings.
- PTT is released
  - When 'Send with Logoff' is enabled.
    - Set the 'Log-In/Off' item as 'L-OFF.'
- After sending a status message
  - When 'Send with Status' is enabled.
- After sending an SDM
  - When 'Send with SDM' is enabled.
- After sending status 22 (Emergency)
  - When 'Send with Emergency' is enabled.

## ■ Printer connection

When the optional cable is connected to the transceiver, a printer can be connected to print out the received SDM content and the ID of the station who sent the message.

Ask your dealer or system operator for connection details.

## ■ Digital ANI

The own ID can be transmitted each time the PTT is pushed (log-in) or released (log-off) during individual or group call communications.

By receiving the ANI, the communication log can be recorded when using a PC dispatch application.

In addition, when using the ANI with log-in, the PTT side tone function can be used to inform you that the ID is sent and voice communication can be performed.

## ■ Auto emergency transmission

When [Emergency Single (Silent)] or [Emergency Repeat (Silent)] is pushed, an emergency signal is automatically transmitted for the specified time period.

The status 22 (Emergency) is sent to the selected ID station, and the position data is transmitted after the emergency signal when a GPS receiver is connected to the transceiver.

The emergency transmission is performed on the emergency channel, however, when no emergency channel is specified, the signal is transmitted on the previously selected channel.

There is no change in the function display or beep emission during automatic emergency transmission.

---

## 3 BIIS OPERATION

### ■ Stun function

When the specified ID, set as a killer ID, is received, the stun function is activated.

When the killer ID is received, the transceiver switches to the password required condition. Entering of the password via the keypad is necessary to operate the transceiver again in this case.

### ■ BIIS indication

The following indications are available for the BIIS operation on an MSK channel.

- CONNECT : Individual/group call is successful.  
OK : Message (status or SDM) transmission is successful.  
FAILED : No answer back is received.  
WAIT : Appears during retry of the call (2nd call).  
CLR DOWN: End the communication.  
BUSY : Operating channel is in the busy condition.

### ■ Priority A channel selection

When one of the following operations is performed, the transceiver selects the Priority A channel automatically.

Priority A is selected when;

- Clear down signal is received/transmitted
  - Set the 'Move to PrioA CH' item as 'Clear down.'
- Turning the power ON  
The Priority A channel is selected each time the transceiver power is turned ON.
- Status call  
The Priority A channel is selected when transmitting a status call.
  - Enable the 'Send Status on PrioA CH' item in the MSK configuration.

### ■ Horn output

Automatic honking function is available when the optional OPC-617 ACC CABLE is connected. When a status message is received, the transceiver controls the vehicles horn for the specified time period to inform a status message is received.

This function is convenient when the operator away from the transceiver.

Ask your dealer or system operator, or refer to the service manual for connection and setting details.

## ■ Rear panel connection

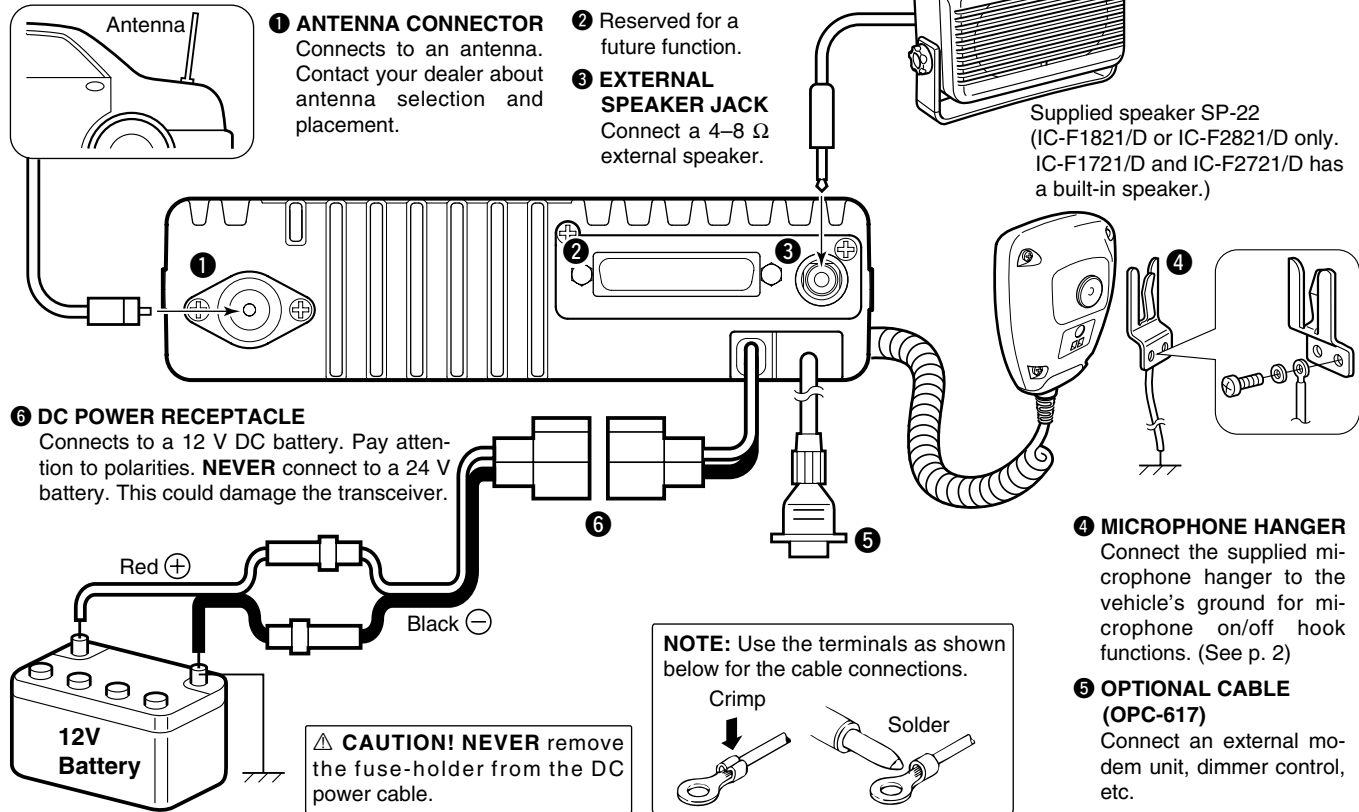

## 4 CONNECTION AND MAINTENANCE

### ■ Supplied Accessories

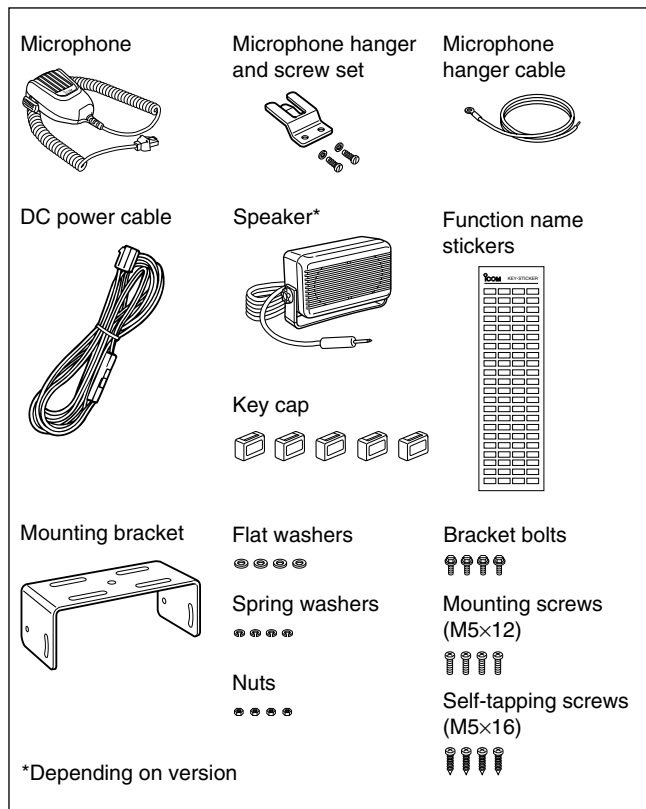

#### • Function name stickers

There are no names on the programmable function keys since the functions can be freely assigned to these keys. Attach the supplied function name stickers as below to the appropriate keys for easy recognition of that key's assigned function.

Then, protect the attached stickers from unsticking with the supplied key cap as below.

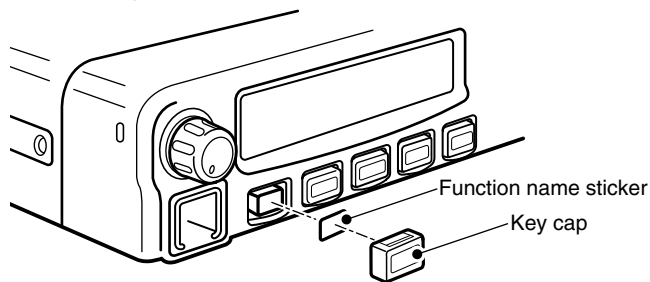

## ■ Mounting the transceiver

The universal mounting bracket supplied with your transceiver allows overhead mounting.

- Mount the transceiver securely with the 4 supplied screws to a thick surface which can support more than 1.5 kg.

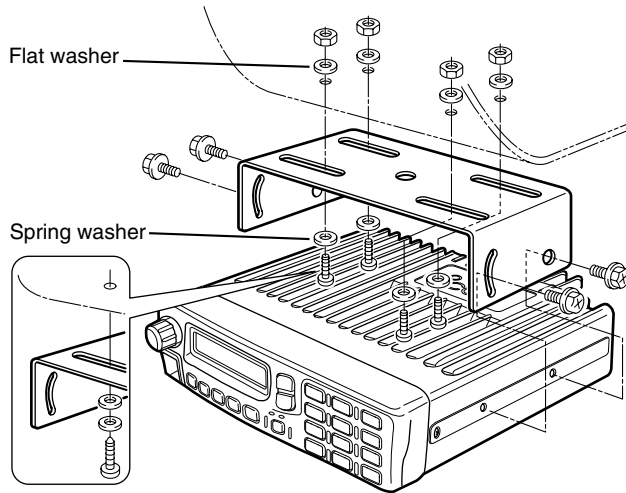

When using self-tapping screws

## ■ Optional UT-111 installation

Install the optional UT-111 unit as follows:

- ① Turn the power OFF, then disconnect the DC power cable.
- ② Unscrew the 4 cover screws, then remove the bottom cover.
- ③ Cut the pattern on the PCB at the CP57, then solder CP58 as shown below.
- ④ Install the unit as shown in the diagram below.
- ⑤ Replace the bottom cover and screws, then re-connect the DC power cable.

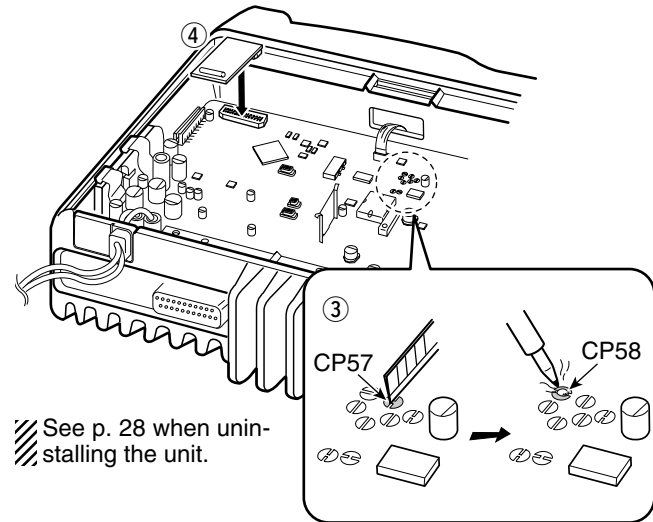

## 4 CONNECTION AND MAINTENANCE

### ■ Optional UT-109 or UT-110 installation

- ① Turn the power OFF, then disconnect the DC power cable.
- ② Unscrew the 4 cover screws, then remove the bottom cover.
- ③ Cut the pattern on the PCB at the TX mic circuit (MIC) and RX AF circuit (AF OUT), then solder CP37 as shown below.
- ④ Install the scrambler unit as described in the installation of optional UT-111 installation on p. 27
- ⑤ Replace the bottom cover and screws.

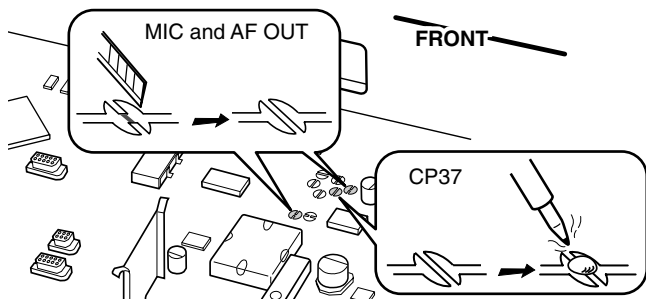

#### NOTE: When uninstalling the unit

Be sure to re-solder the disconnected points and un-solder the connected points as above when you remove the unit. Otherwise no TX modulation or AF output is available.

Re-solder

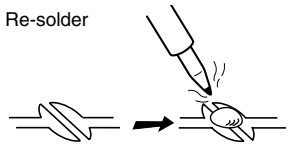

Un-solder

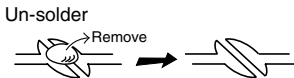

### ■ Optional OPC-617 installation

Install the OPC-617 as shown below.

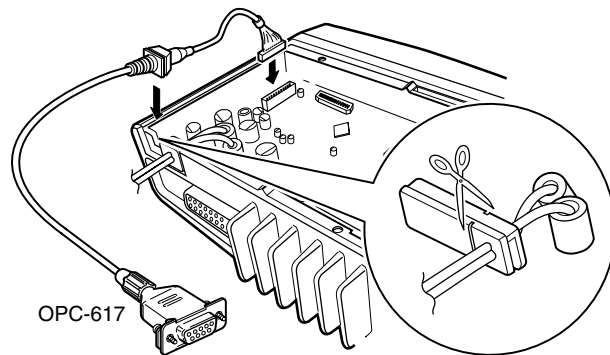

Cut off the bushing as in the illustration, when you install the optional OPC-617.

#### OPTIONAL CABLE PIN ASSIGNMENT

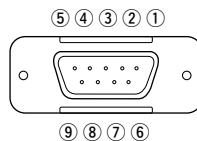

- ① Dimmer cont. IN or IGSW cont. IN
- ② AF OUT
- ③ Det. AF OUT
- ④ Mod. IN
- ⑤ PTT control IN or FTSW control IN

- ⑥ Horn drive cont. OUT
- ⑦ AF GND
- ⑧ Det. AF GND
- ⑨ Mod. GND



## ■ Antenna

A key element in the performance of any communication system is an antenna. Contact your dealer about antennas and the best places to mount them.

## ■ Fuse replacement

A fuse is installed in the supplied DC power cable. If a fuse blows or the transceiver stops functioning, track down the source of the problem if possible, and replace the damaged fuse with a new rated one.

□ Fuse rating: 20 A

**USE** the 20 A fuse only.

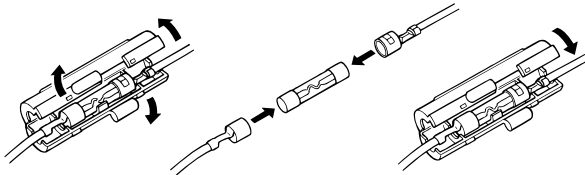

## ■ Cleaning

If the transceiver becomes dusty or dirty, wipe it clean with a soft, dry cloth.



**AVOID** the use of solvents such as benzene or alcohol, as they may damage the transceiver surfaces.

## ■ Options

- **RMK-2** SEPARATION KIT + **OPC-607/OPC-608/OPC-609** SEPARATION CABLE  
Allows you to install the transceiver main unit separately from the front panel for operating convenience.
- **SP-5/SP-22** EXTERNAL SPEAKER  
Input impedance : 4  $\Omega$   
Max. input power : 5 W  
SP-5 : Large speaker for good audio quality.  
SP-22 : Compact and easy-to-install. The same as supplied with the transceiver (depending on version.)
- **HM-100TN/HM-100N/HM-148** HAND MICROPHONE  
HM-100TN : Hand microphone with a DTMF keypad.  
HM-148 : The same as supplied with the transceiver (depending on version.)
- **SM-25** DESKTOP MICROPHONE
- **UT-109 (#02)/UT-110 (#02)** SCRAMBLER UNITS  
Non-rolling type (UT-109)/Rolling type (UT-110) voice scrambler unit provides higher communication security.
- **UT-111** LTR TRUNKING BOARD  
Provides trunking operation.
- **OPC-617** ACC CABLE  
Allows you to connect to an external terminal.



Your Icom radio generates RF electromagnetic energy during transmit mode. This radio is designed for and classified as “Occupational Use Only”, meaning it must be used only during the course of employment by individuals aware of the hazards, and the ways to minimize such hazards. This radio is **NOT** intended for use by the “General Population” in an uncontrolled environment.

- For compliance with FCC and Industry Canada RF Exposure Requirements, the transmitter antenna installation shall comply with the following two conditions:

1. The transmitter antenna gain shall not exceed 0 dBi.
2. IC-F1721/IC-F1721D/IC-F1821/IC-F1821D:

The antenna is required to be located outside of a vehicle and kept at a distance of 1 meter or more between the transmitting antenna of this device and any persons during operation. For small vehicle as worst case, the antenna shall be located on the roof top at any place on the centre line along the vehicle in order to achieve 1 meter separation distance. In order to ensure this distance is met, the installation of the antenna must be mounted at least 1 meter away from the nearest edge of the vehicle in order to protect against exposure to bystanders.

3. IC-F2721/IC-F2721D/IC-F2821/IC-F2821D:

The antenna is required to be located outside of a vehicle and kept at a distance of 79 centimeters or more between the transmitting antenna of this device and any persons during operation. For small vehicle as worst case, the antenna shall be located on the roof top at any place on the centre line along the vehicle in order to achieve 79 centimeters separation distance. In order to ensure this distance is met, the installation of the antenna must be mounted at least 79 centimeters away from the nearest edge of the vehicle in order to protect against exposure to bystanders.



To ensure that your exposure to RF electromagnetic energy is within the FCC allowable limits for occupational use, always adhere to the following guidelines:

- **DO NOT** operate the radio without a proper antenna attached, as this may damage the radio and may also cause you to exceed FCC RF exposure limits. A proper antenna is the antenna supplied with this radio by the manufacturer or an antenna specifically authorized by the manufacturer for use with this radio.
- **DO NOT** transmit for more than 50% of total radio use time (“50% duty cycle”). Transmitting more than 50% of the time can cause FCC RF exposure compliance requirements to be exceeded. The radio is transmitting when the “TX indicator” lights red. You can cause the radio to transmit by pressing the “PTT” switch.

### Electromagnetic Interference/Compatibility

During transmissions, your Icom radio generates RF energy that can possibly cause interference with other devices or systems. To avoid such interference, turn off the radio in areas where signs are posted to do so. **DO NOT** operate the transmitter in areas that are sensitive to electromagnetic radiation such as hospitals, aircraft, and blasting sites.



**Count on us!**

A-6406H-1EX  
Printed in Japan  
© 2004 Icom Inc.

**Icom Inc.**  
1-1-32 Kamiminami, Hirano-ku, Osaka 547-0003, Japan