



**MDC 1200
Compatible**

Limited functions only

INSTRUCTION MANUAL

VHF TRANSCEIVERS

IC-F3000
Series

UHF TRANSCEIVERS

IC-F4000
Series

This device complies with Part 15 of the FCC Rules. Operation is subject to the condition that this device does not cause harmful interference.

Icom Inc.



The photo shows the VHF transceiver.

FOREWORD

READ ALL INSTRUCTIONS carefully and completely before using the transceiver.

SAVE THIS INSTRUCTION MANUAL— This instruction manual contains important operating instructions for the **IC-F3001/IC-F3003/IC-F3006/IC-F3008 VHF TRANSCEIVERS** and the **IC-F4001/IC-F4003/IC-F4006/IC-F4008 UHF TRANSCEIVERS**.

EXPLICIT DEFINITIONS

WORD	DEFINITION
⚠ DANGER!	Personal death, serious injury or an explosion may occur.
⚠ WARNING!	Personal injury, fire hazard or electric shock may occur.
CAUTION	Equipment damage may occur.
NOTE	If disregarded, inconvenience only. No risk of personal injury, fire or electric shock.

Icom, Icom Inc. and the Icom logo are registered trademarks of Icom Incorporated (Japan) in Japan, the United States, the United Kingdom, Germany, France, Spain, Russia and/or other countries.

FCC INFORMATION

- **FOR CLASS A UNINTENTIONAL RADIATORS:**

This equipment has been tested and found to comply with the limits for a Class A digital device, pursuant to part 15 of the FCC Rules. These limits are designed to provide reasonable protection against harmful interference when the equipment is operated in a commercial environment. This equipment generates, uses, and can radiate radio frequency energy and, if not installed and used in accordance with the instruction manual, may cause harmful interference to radio communications.

Operation of this equipment in a residential area is likely to cause harmful interference in which case the user will be required to correct the interference at his own expense.

CAUTION: Changes or modifications to this device, not expressly approved by Icom Inc., could void your authority to operate this transceiver under FCC regulations.

PRECAUTIONS

⚠ **DANGER! NEVER** short the terminals of the battery pack.

⚠ **DANGER!** Use and charge only specified Icom battery packs with Icom radios or Icom chargers. Only Icom battery packs are tested and approved for use with Icom radios or charged with Icom chargers. Using third-party or counterfeit battery packs or chargers may cause smoke, fire, or cause the battery to burst.

⚠ **WARNING! NEVER** hold the transceiver so that the antenna is very close to, or touching exposed parts of the body, especially the face or eyes, while transmitting. The transceiver will perform best if the microphone is 5 to 10 cm (2 to 4 in.) away from the lips and the transceiver is vertical.

⚠ **WARNING! NEVER** operate the transceiver with a headset or other audio accessories at high volume levels. Hearing experts advise against continuous high volume operation. If you experience a ringing in your ears, reduce the volume level or discontinue use.

⚠ **WARNING! NEVER** operate the transceiver while driving a vehicle. Safe driving requires your full attention—anything less may result in an accident.

CAUTION: MAKE SURE the flexible antenna and battery pack are securely attached to the transceiver, and that the antenna and battery pack are dry before attachment. Exposing the inside of the transceiver to water will result in serious damage to the transceiver.

DO NOT push [PTT] when not actually intending to transmit.

DO NOT use or place the transceiver in direct sunlight or in areas with temperatures below -30°C ($+22^{\circ}\text{F}$) or above $+60^{\circ}\text{C}$ ($+140^{\circ}\text{F}$). The basic operations, transmission and reception of the transceiver are guaranteed within the specified operating temperature range. However, the LCD display may not be operate correctly, or show an indication in the case of long hours of operation, or after being placed in extremely cold areas.

DO NOT modify the transceiver. The transceiver warranty does not cover any problems caused by unauthorized modification.

DO NOT use harsh solvents such as benzine or alcohol when cleaning, as they will damage the transceiver surfaces.

KEEP the transceiver away from heavy rain, and never immerse it in the water. The transceiver meets IP54* requirements for dust-protection and splash resistance. However, once the transceiver has been dropped, dust-protection and splash resistance cannot be guaranteed because of possible damage to the transceiver's case or the waterproof seal.

* Only when the battery pack and jack cover are attached.

MAKE SURE to turn the transceiver power OFF before connecting the supplied/optional equipment.

TABLE OF CONTENTS

FOREWORD	i
EXPLICIT DEFINITIONS.....	i
FCC INFORMATION	ii
PRECAUTIONS.....	iii
TABLE OF CONTENTS.....	v
1 ACCESSORIES.....	1-4
■ Supplied accessories	1
■ Accessory attachments.....	1
2 PANEL DESCRIPTION	5-11
■ Front, top and side panels.....	5
■ LED indicator	7
■ Programmable function keys.....	8
3 BASIC OPERATION.....	12-22
■ Turning power ON	12
■ Channel selection	13
■ Call procedure.....	14
■ Receiving and transmitting.....	15
■ Setting the microphone gain	18
■ Setting the squelch level	19
■ Output power level selection	20
■ Priority A channel selection.....	20
■ MDC 1200 system operation	20
■ Emergency Call.....	21
■ Lone Worker Emergency Call	22

4 BATTERY CHARGING	23–33
■ Caution (for the BP-264 Ni-MH BATTERY).....	23
■ Caution (for the BP-265 Li-ion BATTERY).....	25
■ Battery chargers.....	28
5 BATTERY CASE	34
■ Optional battery case (BP-263).....	34
6 OPTIONS	35–40
■ VOX function	38
7 SAFETY TRAINING INFORMATION	41–44

1**2****3****4****5****6****7**

1 ACCESSORIES

■ Supplied accessories

The following accessories are supplied with the transceiver.

Battery pack*

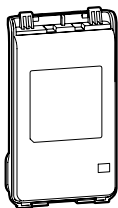

Flexible antenna
(This illustration is for the VHF type.)

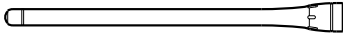

Battery charger*

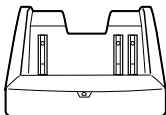

AC adapter*

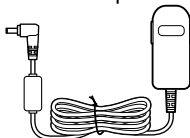

Belt clip*



Jack cover
(with screws)

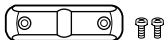

* Not supplied, or the shape is different, depending on the version.

■ Accessory attachments

◇ Flexible antenna

Connect the flexible antenna to the antenna connector.

CAUTION:

- **NEVER** carry the transceiver by holding only the antenna.
- **DO NOT** connect the antenna other than listed on page 36.
- Transmitting without an antenna will damage the transceiver.

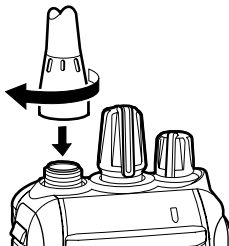

◇ Belt clip

To attach the belt clip:

- ➔ Slide the belt clip in the direction of the arrow until the belt clip locks in place, and makes a 'click' sound.

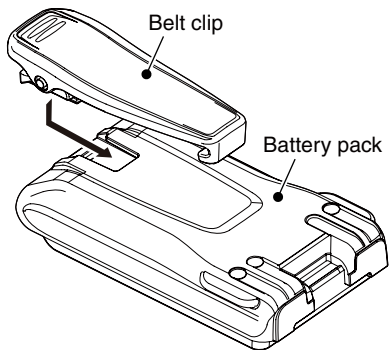

To detach the belt clip:

- ① Remove the battery pack from the transceiver, if it is attached. (p. 3)
- ② Lift the tab up (①), and slide the belt clip in the direction of the arrow (②).

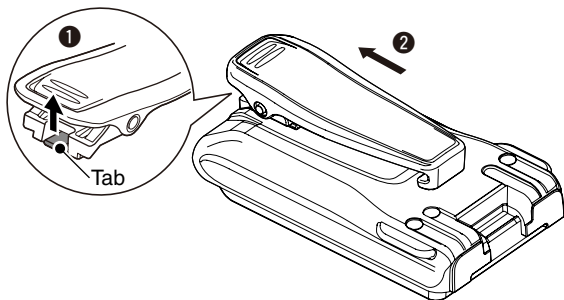

1 ACCESSORIES

◇ Battery pack/case

To attach the battery pack/case:

- ① Fit the battery pack/case in the direction of the arrow (①), then close.
- ② Hook the latch until it makes a 'click' sound (②).

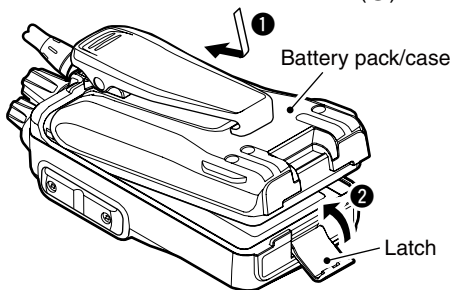

To remove the battery pack/case:

Unhook the latch (③), and lift up the battery pack/case in the direction of the arrow (④).

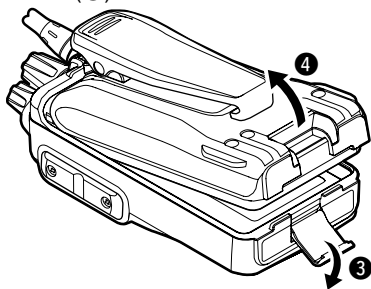

Be careful! The latch is tightly locked, so use caution when releasing it. **DO NOT** use your finger nail. Use the edge of a coin or screwdriver tip to carefully release it.

NEVER remove or attach the battery pack/case when the transceiver is wet or soiled. This may result in water or dust getting into the transceiver, battery pack/case, and may result in them being damaged.

NOTE: Keep the battery terminals clean. It's a good idea to occasionally clean them.

◇ Jack cover

Attach the jack cover when the optional equipment is not used.

To attach the jack cover:

- 1 Attach the jack cover to the [SP MIC] jack.
- 2 Tighten the screws.

To detach the jack cover:

- 3 Remove the screws with a phillips screwdriver.
- 4 Detach the jack cover to connect the optional equipment.

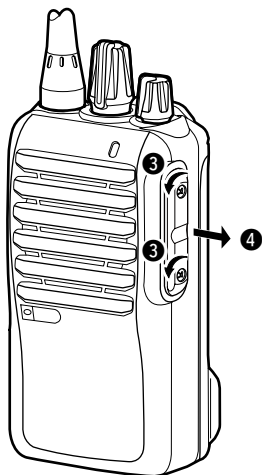
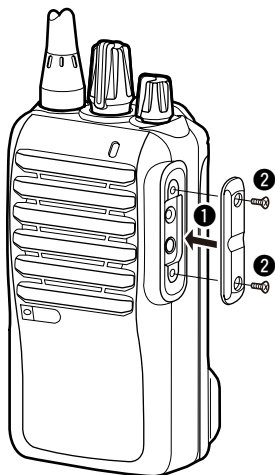

2 PANEL DESCRIPTION

■ Front, top and side panels

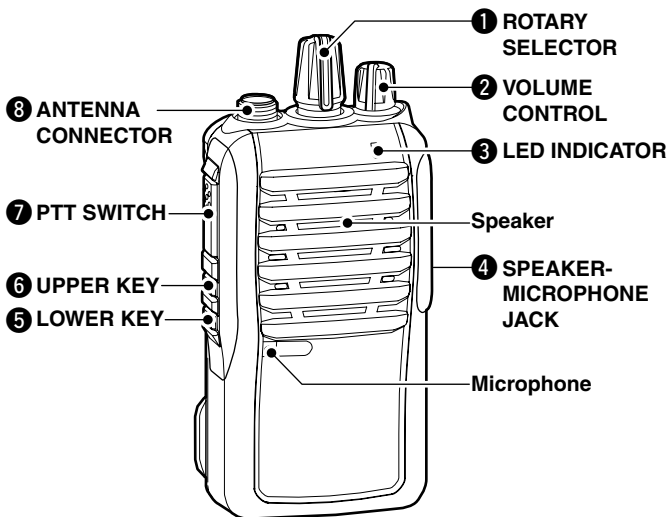

1 ROTARY SELECTOR

Rotate to select the pre-programmed memory channels.

2 VOLUME CONTROL [VOL]

Rotate to turn the power ON/OFF, and adjust the audio level.

3 LED INDICATOR (p. 7)

- ➔ Lights red* while transmitting.
*When the optional battery case is attached, the LED indicator lights orange.
- ➔ Lights green while receiving a signal, or when the squelch is open.
- ➔ Lights/blinks orange when the matched 2/5-tone code is received, depending on the pre-programming.

4 SPEAKER-MICROPHONE JACK [SP MIC]

Connect the optional speaker-microphone or VOX adapter cable.

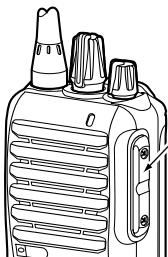

Jack cover

NOTE: Attach the jack cover when the optional equipment is not used. (p. 4)

5 LOWER KEY [Lower]**6 UPPER KEY [Upper]**

The desired function can be assigned by your dealer. (p. 8)

7 PTT SWITCH [PTT]

Push and hold to transmit; release to receive.

8 ANTENNA CONNECTOR

Connect the antenna.

■ LED indicator

The LED indicator indicates the status of various parameters of the transceiver as follows;
(Ref.; R=Red, G=Green, O=Orange)



- TX: Lights Red while transmitting a signal.



- RX: Lights Green while receiving a signal.

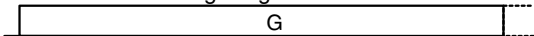

- Call LED (ON): Turns ON while receiving a matched 2/5-tone.



- Call LED (Blink): Blinks while receiving a matched 2/5-tone.



- Fast/Slow scan: Blinks when the Fast/Slow scan is activated.

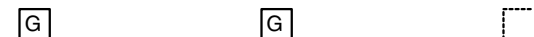

- Low Battery 1: You should charge the battery. (blinks slowly)



- Low Battery 2: You must charge the battery. (blinks fast)

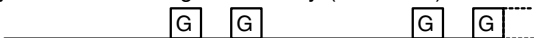

- TX low Battery 1: Low Battery was detected during TX mode.

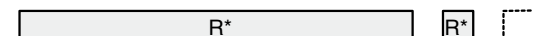

- TX low Battery 2: Very Low Battery was detected during TX mode.



- Channel Error: A non-programmed channel is selected.



* Lights (or blinks) orange when the optional battery case is attached.

■ Programmable function keys

The following functions can be assigned to the [Upper] and [Lower] programmable function keys.

Consult your Icom dealer or system operator for details concerning your transceiver's programming.

SCAN A

- Push to start and cancel the scanning operation.
- When the Power ON scan function is turned ON, push to pause the scanning operation. The paused scan resumes after the specified time period has passed.

SCAN B

Push to start and cancel the scanning operation.

If the scan pauses for any reason, except being cancelled by this key, it will resume after a specified time period has passed.

PRIORITY A CHANNEL, PRIORITY B CHANNEL

Push to select the Priority A or Priority B channel.

PRIORITY A CHANNEL (REWRITE),

PRIORITY B CHANNEL (REWRITE)

- Push to select the Priority A or Priority B channel.
- Push and hold [Prio A (Rewrite)] or [Prio B (Rewrite)] for 1 sec. to assign the operating channel to Priority A or Priority B channel, respectively.

MEMORY CHANNELS 1, 2, 3, 4

Push to directly select memory channel 1, 2, 3 or 4, if programmed. Consult your dealer for details.

2 PANEL DESCRIPTION

MONITOR, MONITOR (AUDIBLE)

- Push to turn the CTCSS (DTCS) or 2/5-tone squelch Mute ON or OFF.
 - Only during LMR operation, push to open any squelch functions, or deactivate any mute functions.
 - Only during PMR operation, push to activate one or two of the following functions* on each channel.
 - Push and hold to un-mute the channel (Audible mode).
 - Push to mute the channel (Inaudible mode).
 - Push to send a 'reset code' after the communication is finished.
- *Ask your dealer for details.

 **NOTE:** The un-mute condition may automatically return to the mute condition, after a specified time period.

- Depending on the presetting, pushing and holding this key for 1 sec. cancels a scan.

LOCK

Push and hold to electronically lock all programmable keys except [Moni(Audi)], [Call] (including Call A and Call B), [Emergency], [Surveillance] and [Lone Worker].

LONE WORKER (p. 22)

- Push to turn the Lone Worker function OFF.
- Push and hold to turn the Lone Worker function ON.
 - When the Lone Worker function is turned ON, and no operation is performed for the specified time period, the Emergency function is automatically turned ON.

HIGH/LOW (p. 20)

Select the transmit output power level temporarily or permanently, depending on the presetting.

- Ask your dealer for the output power level for each selection.

TALK AROUND

- Push to turn the Talk Around function OFF.
- Push and hold to turn the Talk Around function ON.
 - The Talk Around function equalizes the transmit frequency to the receive frequency for transceiver-to-transceiver communication.

WIDE/NARROW

- Push to switch the IF bandwidth to Wide.
 - The wide passband width can be selected from 20 or 25 kHz using the optional cloning software (PMR operation only). Ask your dealer for details.
- Push and hold to switch the IF bandwidth to Narrow.

DTMF AUTODIAL

Push to transmit a programmed DTMF code.

CALL, CALL A, CALL B

Push to transmit a 2/5-tone code.

- Tone call transmission may be necessary before you call another station, depending on your signalling system.
- [Call A] and/or [Call B] keys may be available when your system employs selective 'Individual/Group' calls. Ask your dealer which call is assigned to each key.

2 PANEL DESCRIPTION

EMERGENCY

Push and hold for specified time period to transmit an emergency call.

- The emergency call transmits with beeps, and the LED indicator lights red.
- The transceiver can transmit an emergency call without the beep sounding and the LED indicator lighting. Ask your dealer for details.
- If you want to cancel the emergency call, push and hold the key again before transmitting the call.
- The emergency call is transmitted one time only, or repeatedly until receiving an acknowledgement signal, or until the power is turned OFF. When a matched 5-tone code signal is received, the emergency function can be cancelled depending on the presetting. (PMR operation only)

SURVEILLANCE

➤ Push to turn the Surveillance function OFF.

➤ Push and hold to turn the Surveillance function ON.

- When this function is turned ON, the beep is not heard and the LED does not light when a signal is received, or a key is pushed.

SIREN

Push and hold for 1 sec. to emit a siren sound.

This function can be used for situations other than an emergency alert, such as a security alarm for example.

The transceiver emits the siren sound until the power is turned OFF.

■ Turning power ON

▨ Prior to using the transceiver for the first time, the battery pack must be fully charged for optimum life and operation. (p. 23)

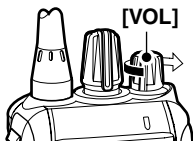

➔ Rotate [VOL] to turn power ON.

◇ Battery type selection

The battery type must be selected according to the battery pack or case when it is changed, but only the first time it is used.

Check the battery type before you begin the selection procedure.

One to three beep(s) sound in sequence, so you must repeat the steps until the number of beeps matches your battery type.

For example, if your battery type is a Li-ion battery pack, you must repeat the procedure until 1 beep is heard.

① Set [ROTARY SELECTOR] to any channel other than Channel 16.

② Rotate [VOL] to turn the transceiver power OFF.

③ While pushing and holding [PTT], rotate [VOL] to turn the power ON.

- You should hold [PTT] until the beeps sound. (It takes approximately 5 seconds; while holding down [PTT], the count down beeps sound. After that, a long beep sounds.)

- 1 beep sounds after the long beep when the Li-ion battery is selected.

- 2 beeps sound after the long beep when the battery case is selected.

- 3 beeps sound after the long beep when the Ni-MH battery is selected.

④ After the beep sounds, release [PTT].

⑤ Repeat steps ② to ④ until you select the attached battery type.

[ROTARY SELECTOR]

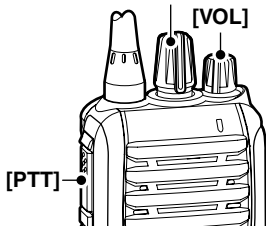

▨ **NOTE:** This operation may not be available, depending on the presetting. Ask your dealer for details.

■ Channel selection

Several types of channel selecting methods are available. They may differ, according to your system set up.

To select a desired operating channel, do one of the following.

- Rotate [ROTARY SELECTOR].
- Push one of memory channel keys, [MR-CH 1] to [MR-CH 4].

AUTOMATIC SCAN TYPE:

Selecting a channel is not necessary for this type. When turning the power ON, the transceiver automatically starts scanning. Scanning stops when a call is received.

/// NOTE: If the Move to Priority A channel at Power ON function (p. 20) is turned ON, the transceiver does not start scanning at power ON.

■ Call procedure

When your system employs tone signalling (excluding CTCSS and DTCS), the tone call procedure may be necessary prior to voice transmission. The tone signalling that is employed in the transceiver may be a selective calling system, which allows you to call only specific station(s), and prevent unwanted stations from contacting you.

- ① Select a desired TX code channel or 2/5-tone code, according to your System Operator's instructions.
 - This may not be necessary, depending on programming.
- ② Push [Call] (assigned to one of the dealer programmable keys.) (p. 10)
- ③ After transmitting a 2/5-tone code, the remainder of your communication can be carried out normally.

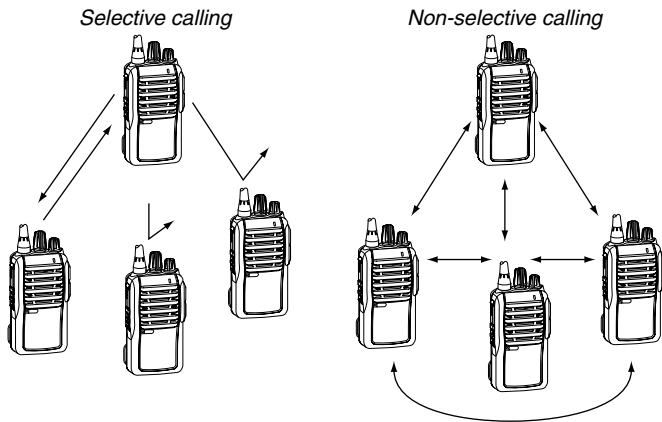

■ Receiving and transmitting

CAUTION: Transmitting without an antenna will damage the transceiver. See p. 1 for antenna attachment.

Receiving:

- ① Rotate [VOL] to turn power ON.
- ② Rotate [ROTARY SELECTOR], or push one of the memory channel keys, [MR-CH 1] to [MR-CH 4], to select a channel.
- ③ When receiving a call, adjust the audio output to a comfortable listening level.

NOTE: When a matched RX code signal is received, audio from the microphone is automatically transmitted for a specified time period.*

* Depending on the presetting. Ask your dealer for details.

Transmitting:

Wait for the channel to become clear to avoid interference.

- ① While pushing and holding [PTT], speak into the microphone at a normal voice level.
- ② Release [PTT] to return to receive.

IMPORTANT: To maximize the readability of your signal;

1. Pause briefly after pushing [PTT].
2. Hold the microphone 5 to 10 cm (2 to 4 inches) from your mouth, then speak into the microphone at a normal voice level.

◇ Transmitting notes

• Transmit inhibit function

The transceiver has several inhibit functions, which restrict transmission under the following conditions:

- The channel is muted. (PMR operation only)
- The channel is busy.
- A signal with the un-matched (or matched) CTCSS (or DTCS) tone is received.
- The selected channel is a 'receive only' channel.

• Time-out timer

After continuously transmitting longer than the pre-programmed time period, the time-out timer activates, and stops further transmitting.

• Penalty timer

Once the time-out timer activates, transmitting is further inhibited for a time period determined by the penalty timer.

• PTTID call

The transceiver automatically sends the ID code (5-tone, DTMF, BIIS or MDC system) when [PTT] is pushed (beginning of the transmission) and/or released (end of transmission), depending on the presetting.

3 BASIC OPERATION

◇ **DTMF transmission**

If the transceiver has [DTMF Autodial] assigned to it, the automatic DTMF transmission function is usable.

➡ Push [DTMF Autodial] to transmit the DTMF code.

◇ **Receiving a Stun, Kill and Revive command**

The dispatcher can send a 2/5-tone signal that will stun, kill or revive your transceiver.

When the Stun command is received, a beep sounds*, and the transceiver becomes unusable. Receiving a Revive command is necessary to operate the transceiver again in this case.

When the Kill command is received, a beep sounds*, and the transceiver becomes unusable (the transceiver switches to the cloning required condition). Cloning the transceiver is necessary to operate the transceiver again in this case.

* Depending on the presetting. Ask your dealer for details.

■ Setting the microphone gain

Adjusts the microphone gain.

- ① Rotate [VOL] to turn the transceiver power OFF.
- ② Set [ROTARY SELECTOR] to any channel other than Channel 16.
- ③ While pushing and holding [Lower], rotate [VOL] to turn the power ON and enter the microphone gain adjustment mode.
- ④ Push [Upper] to increase, or push [Lower] to decrease the microphone gain.
 - The adjustable range is 1 (minimum) to 4 (maximum).
 - A beep sounds after pushing [Upper] or [Lower].
If the level is set on 1 or 4, an error beep sounds after pushing.
- ⑤ Rotate [VOL] to turn the power OFF, then ON to exit the microphone gain adjustment mode.

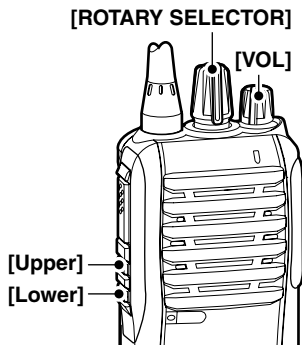

NOTE:

- This operation may not be available, depending on the presetting. Ask your dealer for details.
- When using the VOX function, we recommend setting the microphone gain to 3. However, you can adjust it to suit your operating environment (including your headset performance).

■ Setting the squelch level

The squelch circuit mutes the received audio signal, depending on the signal strength.

- ① Rotate [VOL] to turn the transceiver power OFF.
- ② Set [ROTARY SELECTOR] to any channel other than Channel 16.
- ③ While pushing and holding [PTT] and [Lower], rotate [VOL] to turn the power ON and enter the squelch level adjustment mode.
 - The adjustable range is 0 (loose squelch) to 9 (tight squelch).
 - A beep sounds after pushing [Upper] or [Lower].
If the level is set on 0 or 9, an error beep sounds after pushing.
Therefore, you can determine the current level setting by the type of beep that sounds.
- ⑤ Rotate [VOL] to turn the power OFF, then ON to exit the squelch level adjustment mode.

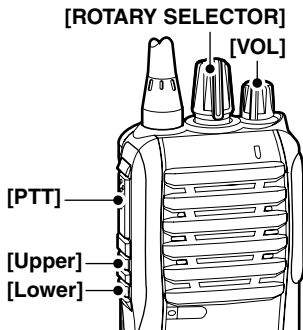

NOTE: This operation may not be available, depending on the presetting. Ask your dealer for details.

■ Output power level selection

If the transceiver has [High/Low] assigned to it, the transmit output power level can be selected, depending on the presetting.

When the battery case is selected as the battery type, or the battery voltage drops to a low power level and the LED indicator status is “Low Battery 2,” the output power automatically switches to “Low 1.” (pp. 7, 12)

- ➔ Push [High/Low] to select the transmit output power level.
 - 1 beep sounds when “Low 1” is selected.
 - 2 beeps sound when “Low 2” is selected.
 - 3 beeps sound when “High” is selected.

■ Priority A channel selection

Depending on the presetting, the Priority A channel is selected each time the transceiver power is turned ON.

■ MDC 1200 system operation

The MDC 1200 signaling system enhances your transceiver’s capabilities. It allows PTT ID* and Emergency signaling.

*When [PTT] is pushed and/or released, the transceiver transmits your station ID.

◇ Transmitting an Emergency Call

The MDC 1200 system’s Emergency feature can be accessed using the [Emergency] key. The transceiver will send an Emergency MDC 1200 system command once, or repeatedly for a programmed number of times until it receives the acknowledgement signal.

The emergency call can be transmitted without a beep sound depending on how the emergency function is programmed. Ask your dealer for details.

■ Emergency Call

When [Emergency] is pushed for the specified time period*, the emergency signal is transmitted once, or repeatedly, on the specified emergency channel.

A repeat emergency signal is automatically transmitted until the transceiver receives an acknowledgement signal, or you turn the transceiver power OFF.

When no emergency channel is specified, the signal is transmitted on the previously selected channel.

If you want to cancel the emergency call, push and hold [Emergency] again before transmitting the call.

If your transceiver is programmed for Silent operation, you can transmit an Emergency call without the beep sounding and the LED indicator lighting.

/// IMPORTANT: It is recommended to set an emergency channel individually to provide the certain emergency call operation.

◇ NOTES

Depending on the presetting, the following functions are automatically activated. Ask your dealer for details.

• Auto TX function

After the emergency call transmission, audio from the microphone is automatically transmitted for a specified time period.*

• Auto RX function

After the emergency call transmission, the transceiver stands by in the audible mode for the specified time period.*

* Depending on the presetting. Ask your dealer for details.

■ Lone Worker Emergency Call

When the Lone Worker function is turned ON, and no operation is performed for the specified time period*, the transceiver enters the emergency mode, and then the countdown for the emergency call transmission starts.

After the specified time period* has passed, an emergency call is automatically transmitted once, or repeatedly*.

If someone operates the transceiver before the call is transmitted, the transceiver exits the emergency mode, and the emergency call is cancelled.

* Depending on the presetting. Ask your dealer for details.

- ① Push and hold to turn the Lone Worker function ON.
- ② Push to turn the Lone Worker function OFF.

4 BATTERY CHARGING

■ Caution (for the BP-264 Ni-MH BATTERY)

⚠ **DANGER! NEVER** short terminals (or charging terminals) of the battery pack. Also, current may flow into nearby metal objects such as a necklace, so be careful when placing battery packs (or the transceiver) in handbags, etc.

Simply carrying with or placing near metal objects such as a necklace, etc. may cause shorting. This may damage not only the battery pack, but also the transceiver.

⚠ **DANGER! NEVER** incinerate used battery packs. Internal battery gas may cause an explosion.

⚠ **DANGER! NEVER** immerse the battery pack in water. If the battery pack becomes wet, be sure to wipe it dry **BEFORE** attaching it to the transceiver.

CAUTION: Always use the battery within the specified temperature range, -5°C to $+60^{\circ}\text{C}$ ($+23^{\circ}\text{F}$ to $+140^{\circ}\text{F}$). Using the battery out of its specified temperature range will reduce the battery's performance and battery life.

CAUTION: Shorter battery life could occur if the battery is left completely discharged, or in an excessive temperature environment (above $+55^{\circ}\text{C}$; $+131^{\circ}\text{F}$) for an extended period of time. If the battery must be left unused for a long time, it must be detached from the radio after charging. Keep it safely in a cool dry place at the following temperature range:

-20°C to $+45^{\circ}\text{C}$ (-4°F to $+113^{\circ}\text{F}$) (up to a month)

-20°C to $+35^{\circ}\text{C}$ (-4°F to $+95^{\circ}\text{F}$) (up to six months)

-20°C to $+25^{\circ}\text{C}$ (-4°F to $+77^{\circ}\text{F}$) (up to a year*)

* We recommend charging the battery pack every 6 months.

Clean the battery terminals to avoid rust or misscontact.

Keep the battery terminals clean. It's a good idea to occasionally clean them.

If your Ni-MH battery pack seems to have no capacity, even after being charged, completely discharge it by leaving the power ON overnight. Then, fully charge the battery pack again. If the battery pack still does not retain a charge (or only very little charge), a new battery pack must be purchased. (p. 35)

Prior to using the transceiver for the first time, the battery pack must be fully charged for optimum life and operation.

- Recommended temperature range for charging:
between +10°C and +40°C (rapid charge: with BC-191) or
between 0°C and +45°C (regular charge: with BC-192)
- Use the supplied charger or optional charger (BC-191 for rapid charging, BC-192 for regular charging) only. **NEVER** use other manufacturers' chargers.

The battery pack contains a rechargeable battery.

Charge the battery pack before first operating the transceiver, or when the battery pack becomes exhausted.

If you want to prolong the battery life, the following points should be observed:

- Avoid over charging. The charging time period by the BC-192 should be less than 48 hours.
- Use the battery pack until it becomes almost completely exhausted, under normal conditions. We recommend battery charging after transmitting becomes impossible.

■ **Caution** (for the BP-265 Li-ion BATTERY)

Misuse of Li-ion batteries may result in the following hazards: smoke, fire, or the battery may rupture. Misuse can also cause damage to the battery or degradation of battery performance.

⚠ **DANGER!** Use and charge only specified Icom battery packs with Icom radios or Icom chargers. Only Icom battery packs are tested and approved for use with Icom radios or charged with Icom chargers. Using third-party or counterfeit battery packs or chargers may cause smoke, fire, or cause the battery to burst.

◇ **Battery caution**

⚠ **DANGER! DO NOT** hammer or otherwise impact the battery. Do not use the battery if it has been severely impacted or dropped, or if the battery has been subjected to heavy pressure. Battery damage may not be visible on the outside of the case. Even if the surface of the battery does not show cracks or any other damage, the cells inside the battery may rupture or catch fire.

⚠ **DANGER! NEVER** use or leave battery packs in areas with temperatures above +60°C (+140°F). High temperature buildup in the battery, such as could occur near fires or stoves, inside a sun heated car, or in direct sunlight may cause the battery to rupture or catch fire. Excessive temperatures may also degrade battery performance or shorten battery life.

⚠ **DANGER! DO NOT** expose the battery to rain, snow, seawater, or any other liquids. Do not charge or use a wet battery. If the battery gets wet, be sure to wipe it dry before using. The battery is not waterproof.

⚠ **DANGER! NEVER** incinerate used battery packs, since internal battery gas may cause them to rupture, or may cause an explosion.

⚠ **DANGER! NEVER** solder the battery terminals or NEVER modify the battery pack. This may cause heat generation, and the battery may rupture, emit smoke or catch fire.

⚠ **DANGER!** Use the battery only with the transceiver for which it is specified. Never use a battery with any other equipment, or for any purpose that is not specified in this instruction manual.

⚠ **DANGER!** If fluid from inside the battery gets in your eyes, blindness can result. Rinse your eyes with clean water, without rubbing them, and see a doctor immediately.

⚠ **WARNING!** Immediately stop using the battery if it emits an abnormal odor, heats up, or is discolored or deformed. If any of these conditions occur, contact your Icom dealer or distributor.

⚠ **WARNING!** Immediately wash, using clean water, any part of the body that comes into contact with fluid from inside the battery.

⚠ **WARNING! NEVER** put the battery in a microwave oven, high-pressure container, or in an induction heating cooker. This could cause a fire, overheating, or cause the battery to rupture.

CAUTION: Always use the battery within the specified temperature range, -20°C to $+60^{\circ}\text{C}$ (-4°F to $+140^{\circ}\text{F}$). Using the battery out of its specified temperature range will reduce the battery's performance and battery life.

4 BATTERY CHARGING

CAUTION: Shorter battery life could occur if the battery is left fully charged, completely discharged, or in an excessive temperature environment (above +50°C; +122°F) for an extended period of time. If the battery must be left unused for a long time, it must be detached from the radio after discharging.

You may use the battery until the remaining capacity is about half, then keep it safely in a cool dry place within the temperature range as shown below:

-20°C to +50°C (-4°F to +122°F)	(up to a month)
-20°C to +35°C (-4°F to +95°F)	(up to three months)
-20°C to +20°C (-4°F to +68°F)	(up to a year)

◇ Charging caution

⚠ **DANGER! NEVER** charge the battery pack in areas with extremely high temperatures, such as near fires or stoves, inside a sun heated car, or in direct sunlight. In such environments, the safety/protection circuit in the battery will activate, causing the battery to stop charging.

⚠ **WARNING! DO NOT** charge or leave the battery in the battery charger beyond the specified time for charging. If the battery is not completely charged by the specified time, stop charging and remove the battery from the battery charger. Continuing to charge the battery beyond the specified time limit may cause a fire, overheating, or the battery may rupture.

⚠ **WARNING! NEVER** insert the transceiver (battery attached to the transceiver) into the charger if it is wet or soiled. This could corrode the battery charger terminals or damage the charger. The charger is not waterproof.

CAUTION: DO NOT charge the battery outside of the specified temperature range: BC-193 (+10°C to +40°C; +50°F to +104°F). Icom recommends charging the battery at +20°C (+68°F). The battery may heat up or rupture if charged out of the specified temperature range. Additionally, battery performance or battery life may be reduced.

■ Battery chargers

◇ Using the BC-191 to rapid charge the BP-264

The BC-191 provides rapid charging of the Ni-MH battery pack (BP-264 only). Never use for any other battery pack.

Charging time period for the BP-264: Approximately 2 hours

The following item is additionally required:

- An AC adapter (not supplied with some versions) or the DC power cable (OPC-515L/CP-23L).

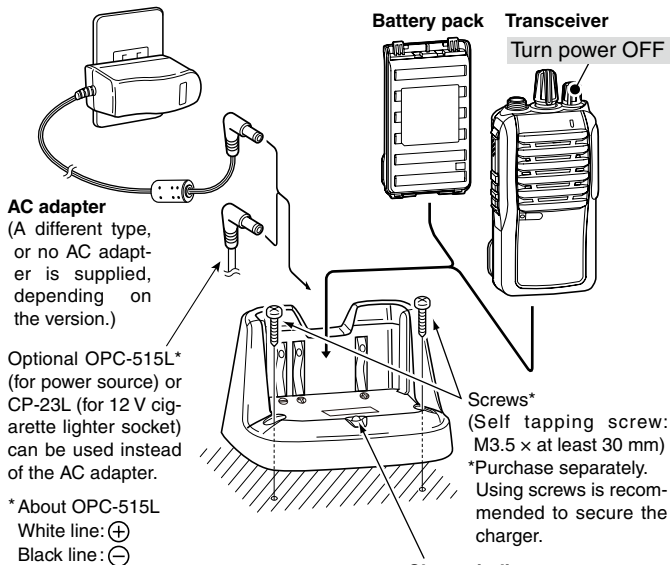

CAUTION: NEVER connect the OPC-515L to a power source using reverse polarity. This will ruin the battery charger.

4 BATTERY CHARGING

◇ Using the BC-192 to regular charge the BP-264

The BC-192 provides regular charging of the Ni-MH battery pack (BP-264 only). Never use for any other battery pack.

Charging time period for the BP-264 (with BC-147S)

: Approximately 16 hours

The following item is additionally required:

- An AC adapter (not supplied with some versions) or the DC power cable (OPC-515L).

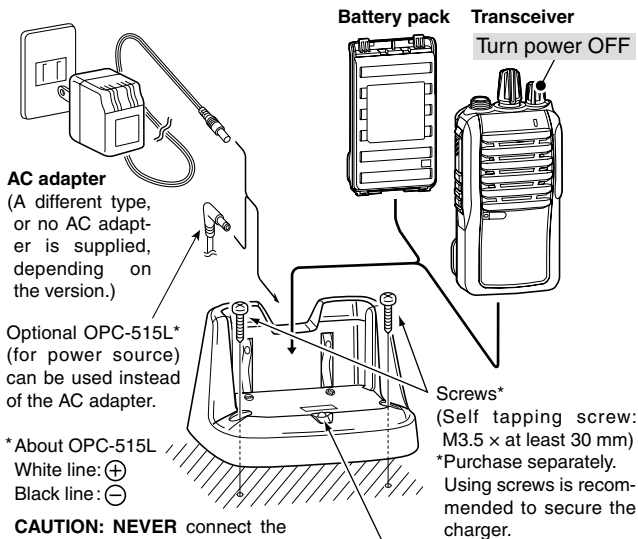

Charging time period differs depending on the input voltage.

12 V	: Approx. 36 hours
13.8 V	: Approx. 21 hours
16 V	: Approx. 16 hours

NOTE:

The charge indicator will not go out even after a battery pack is fully charged.

◇ Using the BC-193 to rapid charge the BP-265

The BC-193 provides rapid charging of the Li-ion battery pack (BP-265 only). Never use for any other battery pack.

Charging time period for the BP-265: Approximately 2.5 hours

The following item is additionally required:

- An AC adapter (not supplied with some versions) or the DC power cable (OPC-515L/CP-23L).

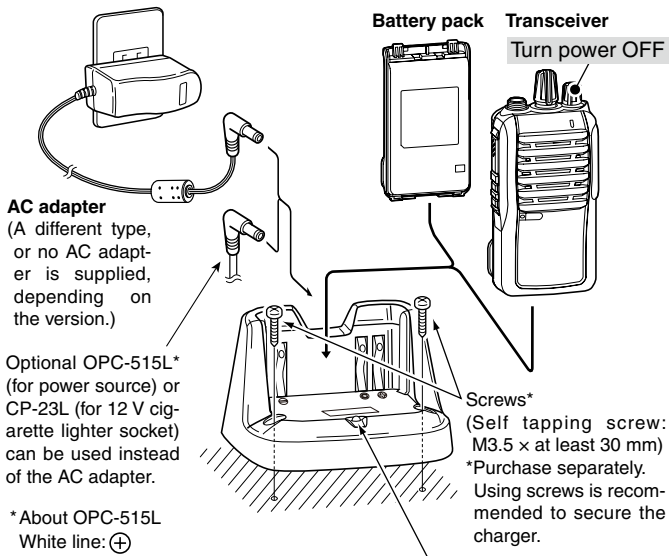

* About OPC-515L

White line: ⊕

Black line: ⊖

CAUTION: NEVER connect the OPC-515L to a power source using reverse polarity. This will ruin the battery charger.

Charge indicator

- Lights orange: While charging.
- Lights green: Charging is completed.

4 BATTERY CHARGING

◇ Using the BC-197 to rapid charge the BP-264 or BP-265

The BC-197 rapidly charges up to six battery packs.

Charging time for the BP-264: Approximately 2 hours

Charging time for the BP-265: Approximately 2.5 hours

The following additional item is required:

- An AC adapter (not supplied with some versions) or the OPC-656 DC POWER CABLE

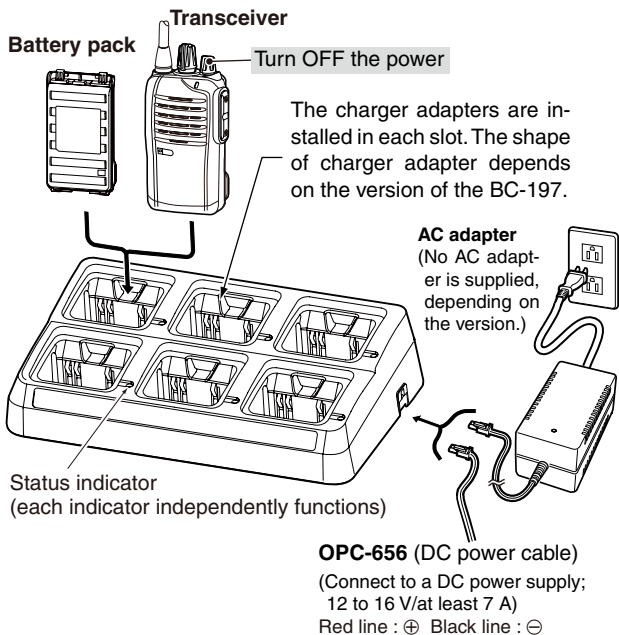

There are two types of BC-197 chargers for the transceiver; one is for Ni-MH batteries, and the other is for Li-ion batteries.

Before you purchase a BC-197, check the type of battery you are using, and then be sure to choose the suitable charger type.

BC-197 Charger Type	Chargeable Battery
With AD-120* charger adapters	BP-264 Ni-MH battery
With AD-121* charger adapters	BP-265 Li-ion battery

* The charger adapter type, AD-120 or AD-121, is printed on the inside bottom of the charger adapter. The type of battery it holds is printed on the top right corner of the adapter.

4 BATTERY CHARGING

IMPORTANT:

Ensure the tabs on the battery pack are correctly aligned with the guide rails inside the charger.

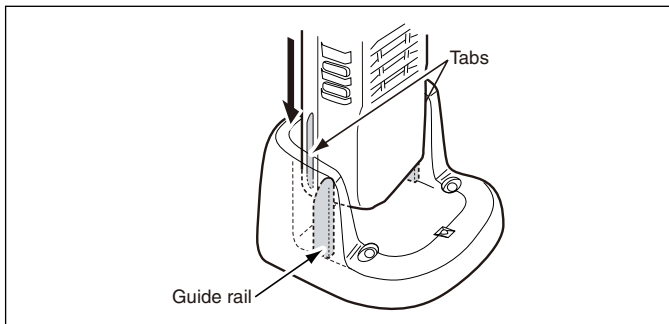

BATTERY CASE 5

■ Optional battery case (BP-263)

When using the optional battery case, install 6 × AA (LR6) size alkaline batteries, as illustrated below.

- ① Remove the battery case if it is attached. (pp. 3, 4)
- ② Install 6 × AA (LR6) size alkaline batteries, as shown below.
 - Install only alkaline batteries.
 - Be sure to observe the correct polarity.

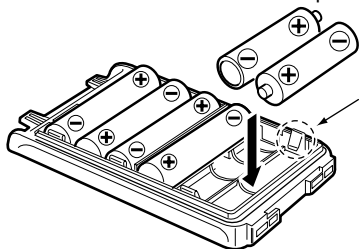

Be careful! The negative terminals of the battery case protrude from the body, so pay attention not to injure your fingers when inserting the batteries.

- ③ Attach the battery case. (pp. 3, 4)

CAUTION:

- When installing batteries, make sure they are all the same brand, type and capacity. Also, do not mix new and old batteries together.
- Keep the battery terminals clean. It's a good idea to occasionally clean them.
- Never incinerate used battery cells since internal battery gas may cause them to rupture.
- Never expose a detached battery case to water. If the battery case gets wet, be sure to wipe it dry before using it.
- Never use batteries whose insulated cover is damaged.

NOTE: When the optional battery case is attached, the battery type must be selected as "Battery case operation" when turning the transceiver ON. Ask your dealer for details. (p. 12)

6 OPTIONS

◇ BATTERY PACK

Battery pack	Voltage	Capacity	Battery life*1	
BP-263	Battery case for AA (LR6) × 6 alkaline		__*2	
BP-264	7.2 V	1400 mAh (min.) 1420 mAh (typ.)	VHF	14.1 hrs.
			UHF	13.7 hrs.
BP-265	7.4 V	1900 mAh (min.) 2000 mAh (typ.)	VHF	20.2 hrs.
			UHF	19.6 hrs.

*1 When the power save function is turned ON, and the operating time is calculated under the following conditions;

TX : RX : standby = 5 : 5 : 90

*2 The average operating time depends on the alkaline cells used.

◇ CHARGERS

• **BC-191** DESKTOP CHARGER + **BC-123S** AC ADAPTER

For rapid charging of the Ni-MH battery pack. An AC adapter is supplied with the charger, depending on the version.

Charging time period: Approximately 2 hours for the BP-264.

• **BC-192** DESKTOP CHARGER + **BC-147S** AC ADAPTER

For regular charging of the Ni-MH battery pack. An AC adapter is supplied with the charger, depending on the version.

Charging time period: Approximately 16 hours for the BP-264.

• **BC-193** DESKTOP CHARGER + **BC-123S** AC ADAPTER

For rapid charging of the Li-ion battery pack. An AC adapter is supplied with the charger, depending on the version.

Charging time period: Approximately 2.5 hours for the BP-265.

• **BC-197** MULTI-CHARGER

For rapid simultaneously charging of up to six battery packs. An AC adapter may be supplied with the charger, depending on the version. There are two types of BC-197 chargers for the IC-F3000/IC-F4000 series.

BC-197 Charger Type	Chargeable Battery	Charging time
With AD-120*	BP-264 Ni-MH battery	Approx. 2 hrs.
With AD-121*	BP-265 Li-ion battery	Approx. 2.5 hrs.

*Either AD-120 or AD-121 charger adapters are installed in the BC-197, depending on the chargeable battery pack.

◇ **DC POWER CABLES**

• **CP-23L** CIGARETTE LIGHTER CABLE

Allows charging of the battery pack through a 12 V cigarette lighter socket. (For BC-191/BC-193)

• **OPC-515L** DC POWER CABLE

Allows charging of the battery pack using a power source instead of the AC adapter.

◇ **BELT CLIPS**

• **MB-124** BELT CLIP

Exclusive alligator-type belt clip.

◇ **ANTENNAS**

• **FA-SC73US/FA-SC56VS/FA-SC57VS** STUBBY ANTENNAS

FA-SC73US : 450–490 MHz FA-SC56VS : 150–162 MHz
 FA-SC57VS : 160–174 MHz

• **FA-SC25U/FA-SC57U/FA-SC72U/**

FA-SC25V/FA-SC55V ANTENNAS

FA-SC25U : 400–430 MHz FA-SC57U : 430–470 MHz
 FA-SC72U : 470–520 MHz FA-SC25V : 136–155 MHz
 FA-SC55V : 146–174 MHz

• **FA-SC61VC/FA-SC61UC** CUT ANTENNAS

FA-SC61VC : 136–174 MHz FA-SC61UC : 380–520 MHz

6 OPTIONS

◇ OTHER OPTIONS

- **AD-98FSC** ANTENNA CONNECTOR CONVERTER

Allows you to connect an external antenna with a BNC connector.

- **HM-158L/HM-159L** SPEAKER-MICROPHONE

Combination speaker-microphone that provides convenient operation while hanging the transceiver on your belt.

- **HS-94/HS-95/HS-97** HEADSET + **OPC-2004** PLUG ADAPTER CABLE

HS-94 : Ear hook type

HS-95 : Neck-arm type

HS-97 : Throat microphone

OPC-2004 : Allows you to connect the HS-94/HS-95/HS-97 to the transceiver. After connection, the VOX function can be used.

- **MB-130** VEHICLE CHARGER BRACKET

Vehicle mounting bracket for the BC-191, BC-192 and BC-193 battery chargers.

Approved Icom optional equipment is designed for optimal performance when used with an Icom transceiver.

Icom is not responsible for the destruction or damage to an Icom transceiver in the event the Icom transceiver is used with equipment that is not manufactured or approved by Icom.

Some options may not be available in some countries. Please ask your dealer for details.

■ VOX function

The transceiver has a VOX function, which allows you hands-free operation.

An optional headset (HS-94/HS-95/HS-97) and a plug adapter cable (OPC-2004) are additionally required for operation.

- The VOX (voice operated transmission) function starts transmitting when you speak into the microphone, without needing to push the PTT switch; then, automatically returns to receive when you stop speaking.

6

◇ Optional unit connection

- ① Rotate [VOL] to turn the transceiver power OFF.
- ② Remove the jack cover. (p. 4)
- ③ Connect the optional headset (HS-94, HS-95 or HS-97) and OPC-2004 as described below.

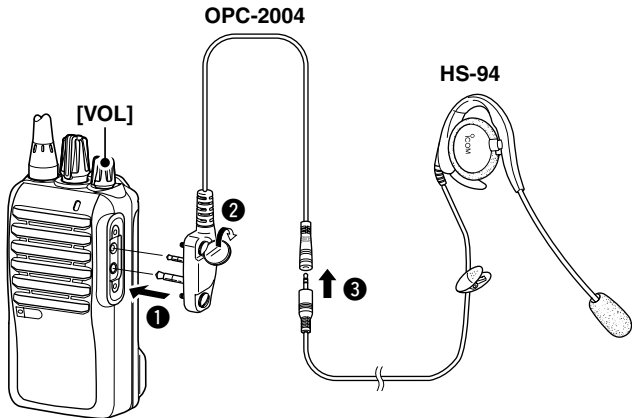

6 OPTIONS

◇ Turning the VOX function ON or OFF

The VOX function can be turned ON or OFF when turning the transceiver power ON.

- ① Rotate [VOL] to turn the transceiver power OFF.
- ② Set [ROTARY SELECTOR] to any channel other than Channel 16.
- ③ While pushing and holding [Upper], turn the transceiver power ON to switch the VOX function ON or OFF.
 - 1 beep sounds when the VOX function is turned OFF.
 - 2 beeps sound when the VOX function is turned ON.

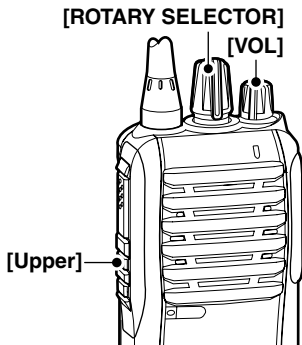

/// **NOTE:** This operation may not be available, depending on the presetting. Ask your dealer for details.

◇ Setting the VOX gain

The VOX sensitivity level can be adjusted from 1 (minimum) to 10 (maximum).

- ① Connect the optional headset (HS-94, HS-95 or HS-97) and OPC-2004. (p. 38)
- ② Rotate [VOL] to turn the transceiver power OFF.
- ③ Set [ROTARY SELECTOR] to Channel 16.
- ④ While pushing and holding [PTT] and [Upper], rotate [VOL] to turn the power ON and enter the VOX gain adjustment mode.
- ⑤ Push [Upper] to increase, or push [Lower] to decrease the VOX gain while speaking into the optional headset.
 - The adjustable range is 1 (minimum) to 10 (maximum).
 - A beep sounds after pushing [Upper] or [Lower].
If the level is set on 1 or 10, an error beep sounds after pushing. Therefore, you can determine the current level setting by the type of beep that sounds.
- ⑥ Rotate [VOL] to turn the power OFF, then ON to exit the VOX gain adjustment mode.

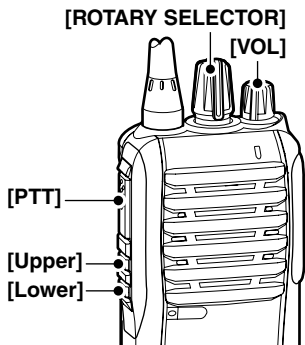

NOTE:

- This operation may not be available, depending on the presetting. Ask your dealer for details.
- Set the microphone gain before setting the VOX gain. (p. 18)

7

SAFETY TRAINING INFORMATION



Your Icom radio generates RF electromagnetic energy during transmit mode. This radio is designed for and classified as “Occupational Use Only”, meaning it must be used only during the course of employment by individuals aware of the hazards, and the ways to minimize such hazards. This radio is NOT intended for use by the “General Population” in an uncontrolled environment.

This radio has been tested and complies with the FCC RF exposure limits for “Occupational Use Only”. In addition, your Icom radio complies with the following Standards and Guidelines with regard to RF energy and electromagnetic energy levels and evaluation of such levels for exposure to humans:

- FCC OET Bulletin 65 Edition 97-01 Supplement C, Evaluating Compliance with FCC Guidelines for Human Exposure to Radio Frequency Electromagnetic Fields.
- American National Standards Institute (C95.1-1992), IEEE Standard for Safety Levels with Respect to Human Exposure to Radio Frequency Electromagnetic Fields, 3 kHz to 300 GHz.
- American National Standards Institute (C95.3-1992), IEEE Recommended Practice for the Measurement of Potentially Hazardous Electromagnetic Fields— RF and Microwave.
- The accessories (antennas, batteries, belt clips, speaker-microphone, etc. that is listed on pages 35–37) are authorized for use with this product. Use of accessories other than those specified may result in RF exposure levels exceeding the FCC requirements for wireless RF exposure.



To ensure that your expose to RF electromagnetic energy is within the FCC allowable limits for occupational use, always adhere to the following guidelines:

- **DO NOT** operate the radio without a proper antenna attached, as this may damaged the radio and may also cause you to exceed FCC RF exposure limits. A proper antenna is the antenna supplied with this radio by the manufacturer or antenna specifically authorized by the manufacturer for use with this radio.
- **DO NOT** transmit for more than 50% of total radio use time (“50% duty cycle”). “50% duty cycle” is also applicable to VOX/PTT mode. Transmitting more than 50% of the time can cause FCC RF exposure compliance requirements to be exceeded. The radio is transmitting when the “LED indicator” lights red. You can cause the radio to transmit by pressing the “PTT” switch or VOX function.
- **ALWAYS keep** the antenna at least 2.5 cm (1 inch) away from the body when transmitting and only use the Icom belt-clip which is listed on page 36 when attaching the radio to your belt, etc., to ensure FCC RF exposure compliance requirements are not exceeded. To provide the recipients of your transmission the best sound quality, hold the antenna at least 5 cm (2 inches) from your mouth, and slightly off to one side.

The information listed above provides the user with the information needed to make him or her aware of RF exposure, and what to do to assure that this radio operates with the FCC RF exposure limits of this radio.

Electromagnetic Interference/Compatibility

During transmissions, your Icom radio generates RF energy that can possibly cause interference with other devices or systems. To avoid such interference, turn off the radio in areas where signs are posted to do so. **DO NOT** operate the transmitter in areas that are sensitive to electromagnetic radiation such as hospitals, aircraft, and blasting sites.

Occupational/Controlled Use

The radio transmitter is used in situations in which persons are exposed as consequence of their employment provided those persons are fully aware of the potential for exposure and can exercise control over their exposure.



AVERTISSEMENT

Votre radio Icom produit une énergie électromagnétique de radiofréquences (RF), en mode de transmission. Cette radio est conçue pour un «usage professionnel seulement» et classée comme tel, ce qui signifie qu'elle doit être utilisée uniquement dans le cadre d'un travail par des personnes conscientes des dangers et des mesures visant à minimiser ces dangers. Elle N'EST PAS conçue pour une «utilisation grand public», dans un environnement non contrôlé.

Cet appareil a été évalué et jugé conforme, aux limites d'exposition aux RF de la FCC, pour une «utilisation grand public». En outre, votre radio Icom satisfait les normes et directives qui suivent en matière de niveaux d'énergie et d'énergie électromagnétique de RF et d'évaluation de tels niveaux en ce qui concerne l'exposition humaine:

- Supplément C, édition 97-01, du Bulletin OET n° 65 de la FCC, «Evaluating Compliance with FCC Guidelines for Human Exposure to Radio Frequency Electromagnetic Fields».
- Norme de l'American National Standards Institute (ANSI): IEEE C95.1-1992 sur les niveaux de sécurité compatibles avec l'exposition humaine aux champs électromagnétiques de radiofréquences (3 kHz à 300 GHz).
- Norme de l'ANSI: IEEE C95.3-1992 sur la méthode d'évaluation recommandée du champ magnétique potentiellement dangereux des radiofréquences et des micro-ondes.
- Les accessoires illustrés à la p. 35–37 sont approuvés pour une utilisation avec ce produit. L'utilisation d'accessoires autres que ceux précisés peut entraîner des niveaux d'exposition aux RF supérieures aux limites établies par la FCC en matière d'exposition aux RF sans fil.



MISE EN GARDE

Afin de vous assurer que votre exposition à une énergie électromagnétique de RF se situe dans les limites permises par la FCC pour une utilisation grand public, veuillez en tout temps respecter les directives suivantes:

- **NE PAS** faire fonctionner la radio sans qu'une antenne appropriée y soit fixée, car ceci risque d'endommager la radio et causer une exposition supérieure aux limites établies par la FCC. L'antenne appropriée est celle qui est fournie avec cette radio par le fabricant ou une antenne spécialement autorisée par le fabricant pour être utilisée avec cette radio.
- **NE PAS** émettre pendant plus de 50 % du temps total d'utilisation de l'appareil («50 % du facteur d'utilisation»). La notion «50% du facteur d'utilisation» s'applique également au mode VOX/PTT. Émettre pendant plus de 50 % du temps total d'utilisation peut causer une exposition aux RF supérieure aux limites établies par la FCC. Lorsque le voyant DEL rouge s'allume, cette radio est en train d'émettre. La radio émettra si vous appuyez sur le bouton du microphone.
- **TOUJOURS tenir** l'antenne éloignée d'au moins 2,5 cm de votre corps au moment d'émettre et utiliser uniquement l'attache pour ceinture Icom illustrée à la p. 36, lorsque vous attachez la radio à votre ceinture, ou à autre chose, de façon à vous assurer de ne pas provoquer une exposition aux RF supérieure aux limites fixées par la FCC. Pour offrir à vos interlocuteurs la meilleure qualité de transmission possible, tenez l'antenne à au moins 5 cm de votre bouche et légèrement de côté.

Les renseignements ci-dessus fournissent à l'utilisateur toute l'information nécessaire sur l'exposition aux RF et sur ce qu'il faut faire pour assurer que cette radio fonctionne en respectant les limites d'exposition aux RF établies par la FCC.

Interférence électromagnétique et compatibilité

En mode de transmission, votre radio Icom produit de l'énergie de RF qui peut provoquer des interférences avec d'autres appareils ou systèmes. Pour éviter de telles interférences, mettez la radio hors tension dans les secteurs où une signalisation l'exige. **NE PAS** faire fonctionner l'émetteur dans des secteurs sensibles au rayonnement électromagnétique tels que les hôpitaux, les aéronefs et les sites de dynamitage.

Usage professionnel/contrôlé

Ce radio émetteur est utilisé dans des cas où des personnes sont exposées en raison de leur travail, pourvu qu'elles soient conscientes du risque d'exposition et qu'elles puissent exercer un contrôle sur cette exposition.

Count on us!



A-6797H-1EX-②

Printed in Japan

© 2009–2012 Icom Inc.

Printed on recycled paper with soy ink.

Icom Inc.

1-1-32 Kamiminami, Hirano-ku, Osaka 547-0003, Japan
