



INSTRUCTION MANUAL

VHF TRANSCEIVER

IC-F70DT/DS
IC-F70T/S

UHF TRANSCEIVER

IC-F80DT/DS
IC-F80T/S

This device complies with Part 15 of the FCC Rules. Operation is subject to the condition that this device does not cause harmful interference.

Icom Inc.

BIIS 1200
Compatible



The photo shows the IC-F70DT/T or IC-F80DT/T.

IMPORTANT

READ ALL INSTRUCTIONS carefully and completely before using the transceiver.

SAVE THIS INSTRUCTION MANUAL — This instruction manual contains important operating instructions for the **IC-F70DT/F70DS/F70T/F70S VHF TRANSCEIVERS** and **IC-F80DT/F80DS/F80T/F80S UHF TRANSCEIVERS**.

EXPLICIT DEFINITIONS

WORD	DEFINITION
⚠ WARNING	Personal injury, fire hazard or electric shock may occur.
CAUTION	Equipment damage may occur.
NOTE	If disregarded, inconvenience only. No risk of personal injury, fire or electric shock.

Icom, Icom Inc. and the ICOM logo are registered trademarks of Icom Incorporated (Japan) in the United States, the United Kingdom, Germany, France, Spain, Russia and/or other countries.

All other products or brands are registered trademarks or trademarks of their respective holders.

ABOUT APCO PROJECT 25

This device made under license under one or more of the following US patents: #4,590,473, #4,636,791, #5,148,482, #5,185,796, #5,271,017, #5,377,229.

The IMBE™ voice coding Technology embodied in this product is protected by intellectual property rights including patent rights, copyrights and trade secrets of Digital Voice Systems, Inc. This voice coding Technology is licensed solely for use within this Communications Equipment. The user of this Technology is explicitly prohibited from attempting to decompile, reverse engineer, or disassemble the Object Code, or in any other way convert the Object Code into a human-readable form. U.S. Pat. Nos. #5,870,405, #5,826,222, #5,754,974, #5,701,390, #5,715,365, #5,649,050, #5,630,011, #5,581,656, #5,517,511, #5,491,772, #5,247,579, #5,226,084, #5,195,166.

PRECAUTIONS

⚠ **CAUTION! NEVER** hold the transceiver so that the antenna is very close to, or touching exposed parts of the body, especially the face or eyes, while transmitting. The transceiver will perform best if the microphone is 5 to 10 cm (2 to 4 in.) away from the lips and the transceiver is vertical.

⚠ **CAUTION! NEVER** operate the transceiver with a headset or other audio accessories at high volume levels.

⚠ **CAUTION! NEVER** short the terminals of the battery pack.

DO NOT push PTT when not actually desiring to transmit.

AVOID using or placing the transceiver in direct sunlight or in areas with temperatures below -30°C (-22°F) or above $+60^{\circ}\text{C}$ ($+140^{\circ}\text{F}$).

The basic operations, transmission and reception of the transceiver are guaranteed within the specified operating temperature range. However, the LCD display may not operate correctly, or show an indication in the case of long hours of operation, or after being placed in extremely cold areas.

DO NOT modify the transceiver for any reason.

Optional unit installation should be done at authorized Icom service center only.

The waterproof capability of the transceiver cannot be guaranteed if you install an unit yourself, or have it done at a non-authorized dealer/service center.

BE CAREFUL! The IC-F70/F80 series transceivers employ waterproof construction, which corresponds to IPX waterproof specification, Grade 7 (1 m depth for 30 min.). However, once the transceiver has been dropped, waterproofing cannot be guaranteed due to the fact that the transceiver may be cracked, or the waterproof seal damaged, etc.

For U.S.A. only

CAUTION: Changes or modifications to this transceiver, not expressly approved by Icom Inc., could void your authority to operate this transceiver under FCC regulations.

TABLE OF CONTENTS

IMPORTANT	i	■ Auto emergency transmission	28
EXPLICIT DEFINITIONS	i	■ Stun function	28
ABOUT APCO PROJECT 25	i	■ BIIS indication	29
PRECAUTIONS	ii	■ Priority A channel selection	29
TABLE OF CONTENTS	iii	5 BATTERY CHARGING	30–32
1 ACCESSORIES	1–3	■ Battery charging	30
■ Supplied accessories	1	■ Battery caution	30
■ Accessory attachments	1	■ Optional battery chargers	31
2 PANEL DESCRIPTION	4–11	6 BATTERY CASE	33
■ Front panel	4	■ Optional battery case (BP-237)	33
■ Function display	6	7 SWIVEL BELT CLIP	34–35
■ Programmable function keys	7	■ MB-93 contents	34
3 BASIC OPERATION	12–18	■ To attach	34
■ Turning power ON	12	■ To detach	35
■ Channel selection	12	8 SPEAKER-MICROPHONE	36
■ Call procedure	13	■ Optional HM-138 description	36
■ Receiving and transmitting	13	■ Attachment	36
■ User set mode	17	9 OPTIONS	37–39
■ Scrambler function	18	10 SAFETY TRAINING INFORMATION	40–41
4 BIIS OPERATION	19–29		
■ Default setting	19		
■ Receiving a call	19		
■ Transmitting a call	21		
■ Receiving a message	23		
■ Transmitting a status	25		
■ Transmitting an SDM (Short Data Message)	26		
■ Position data transmission	27		
■ Printer connection	28		
■ Digital ANI	28		

■ Supplied accessories

The following accessories are supplied:	Qty.
① Flexible antenna	1
② Battery pack	1
③ Belt clip	1
④ Connector cover (with screw)	1 set

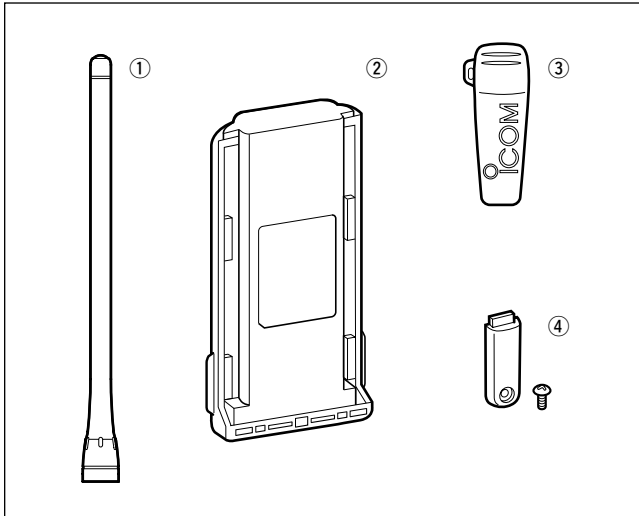

■ Accessory attachments

◇ Flexible antenna

Connect the supplied flexible antenna to the antenna connector.

CAUTION!

- NEVER HOLD by the antenna when carrying the transceiver.
- Transmitting without an antenna may damage the transceiver.

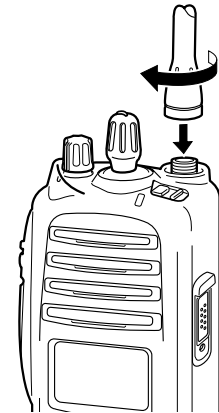

1 ACCESSORIES

◇ Battery pack

To attach the battery pack:

Slide the battery pack in the direction of the arrow (❶), then lock it with the battery release button.

- Slide the battery pack until the battery release button makes a 'click' sound.

To release the battery pack:

Slide the battery release button in the direction of the arrow (❷) as shown below. The battery pack is then released.

NEVER release or attach the battery pack when the transceiver is wet or soiled. This may result water or dust getting into the transceiver/battery pack and may result in the transceiver being damaged.

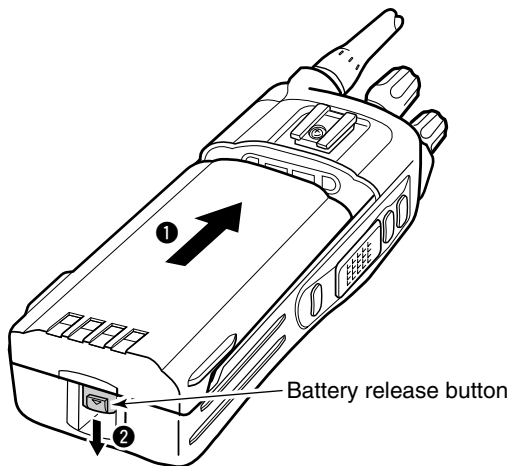

◇ Belt clip

To attach the belt clip:

- ❶ Release the battery pack if it is attached.
- ❷ Slide the belt clip in the direction of the arrow until the belt clip is locked and makes a 'click' sound.

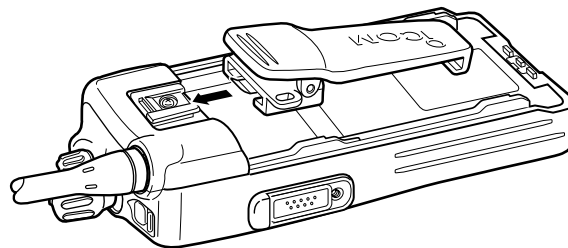

To detach the belt clip:

- ❶ Release the battery pack if it is attached.
- ❷ Pinch the clip (❶), and slide the belt clip in the direction of the arrow (❷).

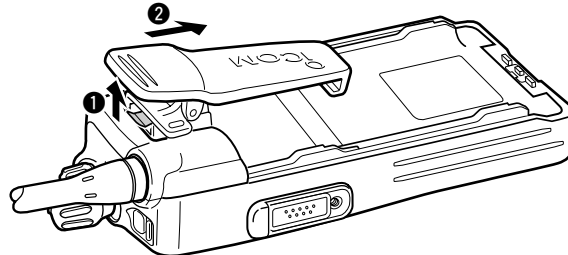

◇ Connector cover

Attach the connector cover when the optional speaker-microphone is not used.

To attach the connector cover:

- 1 Insert the connector cover into the multi-connector.
- 2 Tighten the screw.

To detach the connector cover:

- 3 Unscrew the screw using a phillips screwdriver.
- 4 Detach the connector cover for the speaker-microphone connection.

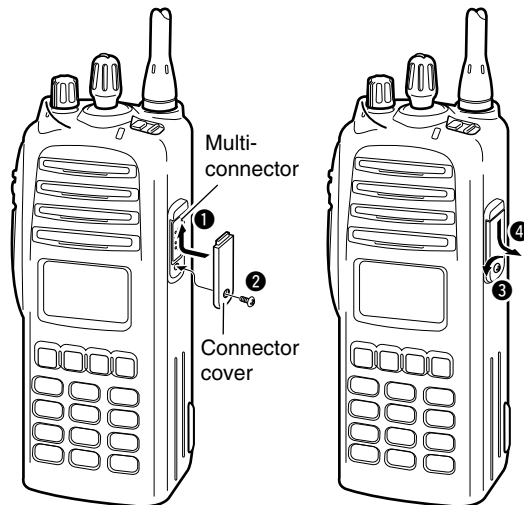

■ Front panel

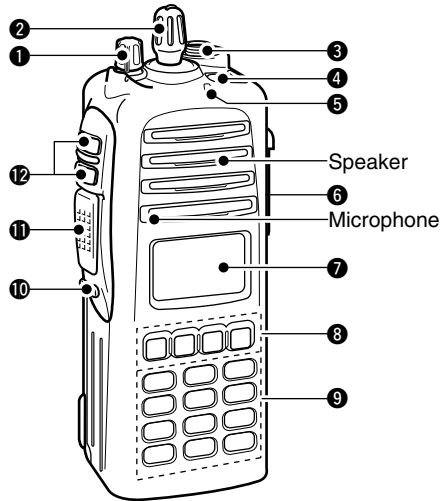

1 VOLUME CONTROL [VOL]

Rotate to turn the power ON/OFF and adjusts the audio level.

2 ROTARY SELECTOR

Rotate to select the pre-programmed memory channels or the operating zone.
(Depending on the pre-setting)

3 ANTENNA CONNECTOR

Connects the supplied antenna.

4 EMERGENCY SWITCH

Push and hold for a specified period to transmit an emergency call.

- Desired function can be programmed by your dealer. (p. 7)

5 BUSY/TRANSMIT INDICATOR

- Lights green while receiving a signal, or when the squelch is open.
- Lights red while transmitting.

6 MULTI-CONNECTOR

Connect the optional speaker-microphone.



Connector cover

NOTE: Attach the connector cover when the optional speaker-microphone is not used. (See p. 3 for details)

7 FUNCTION DISPLAY (p. 6)

Displays a variety of information, such as an operating channel number/name, 5-tone code, DTMF numbers and audible condition, etc.

8 DEALER-PROGRAMMABLE KEYS

Desired functions can be programmed independently by your dealer. (p. 7)

9 10-KEYPAD (IC-F70DT/F70T or IC-F80DT/F80T only)

The keypad allows you to enter digits to:

- Select memory channels, tone channels and DTMF codes (during transmission).
- Set TX codes and BIIS status number.
- Input text message for SDM operation.
- Start up with a password.
- Input the Individual ID code for digital operation.

10 MONITOR SWITCH

- Mute and release the CTCSS (DTCS) or 2-tone squelch mute. Open any squelch/deactivate any mute while pushing and holding this key. (LMR operation only)

➤ Activates one of (or two of) the following functions on each channel independently.
(PMR or BIIS PMR operation only)

- Push and hold the key to unmute the channel (audio is emitted; 'audible' condition).
- Push the key to toggle the mute and unmute conditions (toggles 'audible' and 'inaudible').
- Push the key to mute the channel (sets to 'inaudible' only).
- Push the key to unmute the channel (sets to 'audible' only).
- Push the key after communication is finished to send a 'reset code.'
- Push the key after communication is finished to send a 'clear down code' during BIIS operation on a BIIS channel.

NOTE: The unmute condition ('audible' conditions) may automatically return to the mute condition ('inaudible' condition) after a specified period.

- Desired function can be programmed by your dealer. (p. 7)

11 PTT SWITCH [PTT]

- Push and hold to transmit; release to receive.
- Push to transmit the call during BIIS operation, depending on the setting.

12 UP/DOWN SWITCHES

- Push to select an operating channel.
- Push to select a TX code channel after pushing [TX CODE CH SELECT].
- Push to select a DTMF channel after pushing [DTMF].
- Push to select a scan group after pushing and holding [SCAN].
- Push to select a BIIS code, status number or SDM (Short Data Message) after pushing [DIGITAL].
- Desired functions can be programmed independently by your dealer. (p. 7)

2 PANEL DESCRIPTION

■ Function display

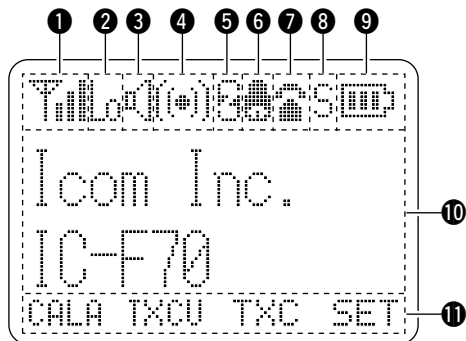

① SIGNAL STRENGTH INDICATOR

Indicates relative signal strength level.

② LOW POWER INDICATOR

Appears when low output power is selected.

③ AUDIBLE INDICATOR

- ➔ Appears when the channel is in the 'audible' (unmute) condition.
- ➔ Appears when the specified 2/5-tone/BIIS code is received.

④ COMPANDER INDICATOR

Appears when the compander function is activated.

⑤ SCRAMBLER INDICATOR

Appears when the voice scrambler function is activated.

⑥ BELL INDICATOR

Appears/blinks when the specific 2/5-tone/BIIS code is received, according to the pre-programming.

⑦ CALL CODE MEMORY INDICATOR

Appears when the call code memory is selected.

⑧ SDM MEMORY INDICATOR

Appears when the SDM memory is selected.

⑨ BATTERY INDICATOR

Appears or blinks when the battery power decreases to a specified level.

⑩ ALPHANUMERIC DISPLAY

- ➔ Displays an operating channel number, channel name, Set mode contents, DTMF code, etc.
- ➔ The indication mode can be selected from 1 line or 2 lines. Ask your dealer for details.
 - In this instruction manual, the LCD illustration is described using the 2 lines indication mode.

⑪ KEY INDICATOR

Indicate the programmed function of the front panel keys ([P0], [P1], [P2] and [P3]).

■ Programmable function keys

The following functions can be assigned to [EMERGENCY], [UP], [DOWN], [MONITOR], [P0], [P1], [P2] and [P3] programmable function keys.

Consult your Icom dealer or system operator for details concerning your transceivers programming.

If the programmable function names are bracketed in the following explanations, the specific key is used to activate the function depends on the programming.

CH UP AND DOWN KEYS “UP” “DOWN”

- Push to select an operating channel.
- Push to select a transmit code channel after pushing [TX Code CH Select].
- Push to select a DTMF channel after pushing [DTMF Autodial].
- Push to select a scan group after pushing and holding [Scan A Start/Stop]/[Scan B Start/Stop].
- Push to select a BIIS code, status number or SDM after pushing [Digital].
- Push to select an Individual ID code or Talkgroup ID code after pushing [Individual] or [Talkgroup].

ZONE KEY “ZONE”

Push this key, then select the desired zone using [CH Up]/[CH Down].

What is “zone”?— The desired channels are assigned into a zone according to the intended use for grouping. For example, ‘Staff A’ and ‘Staff B’ are assigned into a “Business” zone, and ‘John’ and ‘Cindy’ are assigned into a “Private” zone.

SCAN A START/STOP KEY “SCNA”

- This key’s operation depends on the Power ON Scan setting.
 - When the power ON scan function is turned OFF;**
Push to start and cancel scanning operation. In case of transmission during scan, cancels scanning.
 - When the power ON scan function is turned ON;**
Push to pause scanning. Scanning resumes after a specified time period has passed. In case of transmission during scan, pauses scanning. Scanning resumes after a specified time period has passed after the transmission is finished.
- Push and hold this key for 1 sec. to indicate the scan group, then select the desired group using [CH Up]/[CH Down].

SCAN B START/STOP KEY “SCNB”

- Push to start and cancel scanning operation. In case of transmission during scan, pauses scanning. Scanning resumes after a specified time period has passed after the transmission is finished.
- Push and hold this key for 1 sec. to indicate the scan group, then select the desired group using [CH Up]/[CH Down].

2 PANEL DESCRIPTION

SCAN ADD/DEL (TAG) KEY “SCAD”

Push to add or delete the selected channel to/from the scan group.

PRIO A/B KEYS “PRA”/“PRAR”/“PRB”/“PRBR”

- ➔ Push to select Priority A or Priority B channel.
- ➔ Push and hold [Prio A (Rewrite)] or [Prio B (Rewrite)] to rewrite the Priority A or Priority B channel to the selected channel.

MR-CH 1/2/3/4 KEYS “CH1”/“CH2”/“CH3”/“CH4”

Push to select an operating channel directly.

MONI (AUDI) KEY “MON”

- ➔ Mute and release the CTCSS (DTCS) or 2-tone squelch mute. Open any squelch/deactivate any mute while pushing this key. (LMR operation only)
- ➔ Activates one of (or two of) the following functions on each channel independently: (PMR or BIIS PMR operation only)
 - Push and hold to un-mute the channel (audio is emitted; ‘Audible’ condition).
 - Push to mute the channel (sets to ‘Inaudible’ only).
 - Push to un-mute the channel (sets to ‘Audible’ only).
 - Push after the communication is finished to send a ‘reset code’.

 **NOTE:** The un-mute condition (‘Audible’ condition) may automatically return to the mute condition (‘Inaudible’ condition) after a specified period depending on programming.

LIGHT KEY “LIGT”

Push to turn the transceiver’s backlight ON temporarily only when the backlight function is turned OFF in user set mode.

LOCK KEY “LOCK”

- ➔ Push and hold for 1 sec. to electronically lock all programmable keys except the following:
[Call] (incl. Call A and Call B), [Moni(Audi)] and [Emergency].
- ➔ Push and hold for 1 sec. again to turn the lock function OFF.

HIGH/LOW KEY “H/L”

Push to select the transmit output power temporarily or permanently, depending on the pre-setting.

- Ask your dealer for the output power level for each selection.

C.TONE CH ENT KEY “TSEL”

Push to select the continuous tone channel using [CH Up]/[CH Down] to change the tone frequency/code setting. The selected channel remains set as the continuous tone channel until another channel is designated as such.

TALK AROUND KEY “TA”

Push to turn the talk around function ON and OFF.

- The talk around function equalizes the transmit frequency to the receive frequency for transceiver-to-transceiver communication.

WIDE/NARROW KEY “W/N”

Push to toggle the IF bandwidth between wide and narrow.

- The wide passband width can be selected from 25.0 or 20.0 kHz using the CS-F70/F1700 CLONING SOFTWARE. (PMR or BIIS PMR operation only) Ask your Dealer for details.

DTMF AUTODIAL KEY “DTMA”

- Push to enter the DTMF channel selection mode. Then select the desired DTMF channel using [CH Up]/[CH Down].
- After selecting the desired DTMF channel, push this key to transmit the DTMF code.

RE-DIAL KEY “DTMR”

Push to transmit the last-transmitted DTMF code.

CALL KEYS “CALL”/“CALA”/“CALB”

Push to transmit a 2/5-tone/BIIS ID code.

- Call transmission is necessary before calling another station depending on your signalling system.
- [Call A] and/or [Call B] may be available when your system employs selective ‘Individual/Group’ calls. Ask your dealer which call is assigned to each key.

EMERGENCY KEYS “EMR”

- Push and hold for a specified period to transmit an emergency call.
 - When [Emergency Single (Silent)] or [Emergency Repeat (Silent)] is pushed, an emergency call is transmitted without a beep emission and LCD indication change.*
 - If you want to cancel the emergency call, push (or push and hold) the key again before transmitting the call.
 - The emergency call is transmitted one time only or repeatedly until receiving a control code depending on the pre-setting.
- *BIIS PMR operation only

SURVEILLANCE KEY “SURV”

Push to turn the surveillance function ON or OFF.

When this function is turned ON, the beep is not emitted and the LCD backlight does not light when a signal is received or a key is pushed, etc.

TX CODE ENTER KEY “TXCE”

(PMR or BIIS PMR operation only)

Push to enter the ID code edit mode directly, for both 5-tone and BIIS. Then set the desired digit using [CH Up]/[CH Down] or 10-keypad*. (p. 15)

*IC-F70DT/T or IC-F80DT/T only

TX CODE CHANNEL SELECT KEY “TXC”

- Push to enter the ID code channel selection mode directly. Then set the desired channel using [CH Up]/[CH Down]. (p. 14)
 - During ID code channel selection mode, push for 1 sec. to enter the ID code edit mode for 5-tone and BIIS. Then set the desired digit using [CH Up]/[CH Down] or 10-keypad*. (p. 15)
- *IC-F70DT/T or IC-F80DT/T only

TX CODE CHANNEL UP/DOWN KEYS “TXCU”/“TXCD”

Push to select a TX code channel directly.

2 PANEL DESCRIPTION

ID-MR SELECT KEY "IDMS"

(PMR or BIIS PMR operation only)

- Recalls detected ID codes.
 - Push this key, then select the ID code using [CH Up]/[CH Down].
 - Up to 5 ID's are memorized.
- Push and hold to erase the selected ID's.

SCRAMBLER FUNCTION "SCR"

Push to toggle the voice scrambler function ON and OFF.

COMPANDER KEY "COMP"

Push to toggle the compander function ON and OFF.

The compander function reduces noise components from the transmitted audio to provide clear communication.

USER SET MODE KEY "SET"

- Push and hold to enter user set mode.
 - During user set mode, push this key to select an item, and change the value or condition using push [CH Up]/[CH Down].
- Push and hold this key again to exit user set mode.

User set mode is also available via the 'Power ON function.'
Refer to p. 17 also.

OPT OUT KEYS "OP1"/"OP2"/"OP3"

Push to control the output signal level of the optional ports in the optional unit connector.

OPT MOMENTARY KEYS "01M"/"02M"/"03M"

Push and hold to control the output signal level of the optional ports in the optional unit connector.

DIGITAL BUTTON KEY "BIFN" (BIIS operation only)

- Push to select the call ID list, transmit message and standby by condition. Toggles between queue channel and received message record indication after queue channel is selected.
- Push and hold to select queue channel indication.

STATUS UP/DOWN KEYS "BIUP"/"BIDN"

(BIIS operation only)

- While in the standby condition, push to display the transmit status indication and select a status number.
- When a received SDM is displayed, push to cancel the automatic scroll and scroll the message manually.
- When an SDM that contains more than 12 characters is displayed, push to scroll the message manually.

TONE/NAC CH SELECT KEY “TSEL”

(LMR (P25 Conventional) operation only)

- While in the analog mode operation, push to select the continuous tone channel using [CH Up] or [CH Down] to change the tone frequency/code setting.
- While in the digital mode operation, push to select the NAC channel using [CH Up] or [CH Down] to change the NAC code setting.
- While in the mixed (digital and analog) mode operation, push to select the continuous tone channel using [CH Up] or [CH Down] to change the tone frequency/code setting. Then push this key to enter the setting. After that, the NAC channel selection screen appears. Select the NAC channel using [CH Up] or [CH Down] to change the NAC code setting. Then push this key to enter the setting.

◇ For Digital mode operation only**INDIVIDUAL KEY “INDU”**

Push to enter the individual ID code selection mode directly. Then select the desired individual ID code using [CH Up]/[CH Down]. (p. 16)

TALKGROUP KEY “TGID”

Push to enter the talkgroup ID code selection mode directly. Then select the desired talkgroup ID code using [CH Up]/[CH Down]. (p. 16)

■ Turning power ON

/// Prior to using the transceiver for the first time, the battery pack must be fully charged for optimum life and operation. (P. 30)

- ① Rotate [VOL] to turn the power ON.
- ② If the transceiver is programmed for a start up password, input the digit codes as directed by your dealer.
 - 10-keypad* can be used for password input.
 - *IC-F70DT/T or IC-F80DT/T only
 - The keys as below can be used for password input: The transceiver detects numbers in the same block as identical. Therefore “01234” and “56789” are the same.

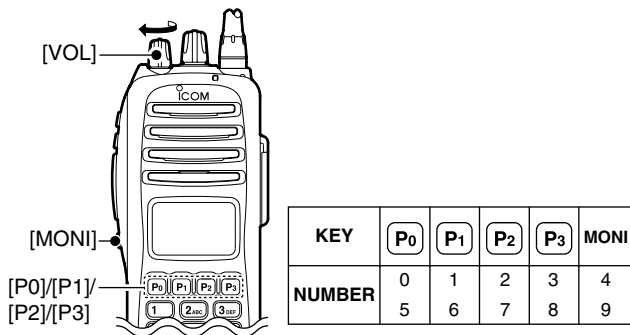

- ③ When the “PASSWORD” indication does not clear after inputting 6 digits, the input code number may be incorrect. Turn the power off and start over in this case.

■ Channel selection

Several types of channel selections are available. Methods may differ according to your system set up.

NON-ZONE TYPE:

Push [CH Up] or [CH Down], or rotate [ROTARY SELECTOR]* to select the desired operating channel, in sequence; or, push one of [MR-CH 1] to [MR-CH 4] keys to select a channel directly.

- Up to 16 pre-programmed channels can be selected via [ROTARY SELECTOR].

ZONE TYPE:

Push [Zone] then push [CH Up] or [CH Down] or rotate [ROTARY SELECTOR]* to select the desired zone.

*Depending on the pre-setting.

AUTOMATIC SCAN TYPE:

Channel setting is not necessary for this type. When turning power ON, the transceiver automatically starts scanning. Scanning stops when receiving a call.

Call procedure

When your system employs tone signaling (excluding CTCSS and DTCS), the call procedure may be necessary prior to voice transmission. The tone signalling employed may be a selective calling system which allows you to call specific station(s) only and prevent unwanted stations from contacting you.

- ① Select the desired TX code channel, 2/5-tone code, Individual ID code* or Talkgroup ID code* according to your System Operator's instructions.
 - This may not be necessary depending on programming.
 - Refer to pgs. 14–16 for selection.
- *Digital mode operation only.
- ② Push the call key (assigned to one of the dealer programmable keys; except for the Digital mode operation) or [PTT].
- ③ After transmitting, the remainder of your communication can be carried out in the normal fashion.

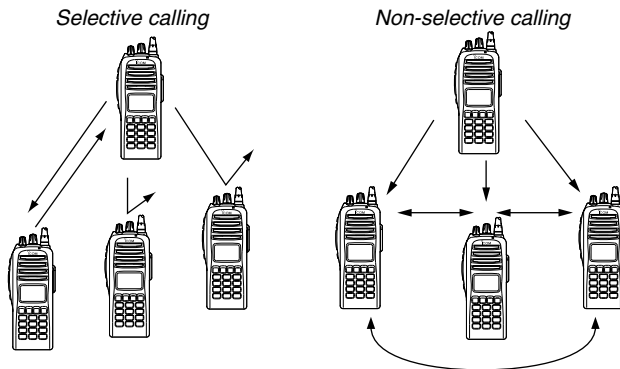

Receiving and transmitting

Receiving:

- ① Rotate [VOL] to turn the power ON.
- ② Push [CH Up] or [CH Down], or rotate [ROTARY SELECTOR]* to select a channel in sequence.
 - *Depending on the pre-setting.
- ③ When receiving a call, adjust the audio output level to a comfortable listening level.

Transmitting:

Wait for the channel to become clear to avoid interference.

- ① Push [CALL] when initiating a call from your side.
 - Coded audio may be heard from the transceiver, then “” appears.
 - This operation may not be necessary depending on your signaling system. Ask your dealer for details.
- ② While pushing and holding [PTT], speak into the microphone at your normal voice level.
- ③ Release [PTT] to return to receive.

- IMPORTANT:** To maximize the readability of your signal;
1. Pause briefly after pushing [PTT].
 2. Hold the microphone 5 to 10 cm (2 to 4 inches) from your mouth, then speak into the microphone at a normal voice level.

3 BASIC OPERATION

◇ Transmitting notes

• Transmit inhibit function

The transceiver has several inhibit functions which restrict transmission under the following conditions:

- The channel is in mute condition ('Inaudible' condition; "M" does not appear.)
- The channel is busy.
- Un-matched (or matched) CTCSS is received.
(Depending on the pre-setting.)
- Un-matched (or matched) NAC is received.*
(Depending on the pre-setting.)
- The selected channel is a 'receive only' channel.

*Digital mode operation only.

• Time-out timer

After continuous transmission for the pre-programmed time period, the time-out timer is activated, causing the transceiver to stop transmitting.

• Penalty timer

Once the time-out timer is activated, transmission is further inhibited for a period determined by the penalty timer.

◇ TX code channel selection

If the transceiver has [TX Code CH Select] assigned to it, the indication can be toggled between the operating channel number (or name) and TX code channel number (or name). When the TX code channel number (or name) is displayed, [CH Up] or [CH Down] selects the TX code channel.

USING [TX CODE CH SELECT] KEY:

- ① Push [TX Code CH Select]—a TX code channel number (or name) appears.
- ② Push [CH Up] or [CH Down] to select the desired TX code channel.
- ③ Push [Call] (or [PTT] during BIIS operation) to transmit the selected TX code.

USING [TX CODE CH UP]/[TX CODE CH DOWN] KEY:

If the transceiver has a [TX Code CH Up] or [TX Code CH Down] key assignment, the programmed TX code channel can be selected directly when pushed.

NOTE for PMR or BIIS PMR operation:

- The LCD indication does not change when the operating channel number (or name) is displayed. (Depending on the pre-setting)
- To check the selected TX code, push [TX Code CH Select].

◇ TX code number edit

(PMR or BIIS PMR operation only)

If the transceiver has [TX Code CH Select] or [TX Code Enter] assigned to it, TX code contents can be edited within the allowable digits.

USING [TX CODE CH SELECT] KEY:

- ① Push [TX Code CH Select] to enter the TX code channel selection mode.
 - Select the desired channel before entering the TX code channel selection mode if necessary.
- ② Push and hold [TX Code CH Select] for 1 sec. to enter the TX code edit mode.
- ③ Push [TX Code CH Select] to select the desired digit to be edited.
 - The digit to be edited blinks.
- ④ Push [CH Up], [CH Down] or 10-keypad* to set the desired digit.
- ⑤ Push [TX Code CH Select] to set the digit. The digit to the right will blink automatically.
 - When the 10-keypad* is used for setting, the digit to the right will blink automatically without pushing [TX Code CH Select].
- ⑥ Repeat ④ and ⑤ to input all allowable digits.
- ⑦ Push [Call] or [PTT] to transmit the edited TX code.

*IC-F70DT/T or IC-F80DT/T only

USING [TX CODE ENTER] KEY:

- ① Select the desired TX code channel via [TX Code CH Select]+[CH Up] or [CH Down], [TX Code CH Up] or [TX Code CH Down].
- ② Push [TX Code Enter] to enter the TX code edit mode.
- ③ Push [TX Code Enter] to select the desired digit to be edited.
 - The digit to be edited blinks.
- ④ Push [CH Up], [CH Down] or 10-keypad* to set the desired digit.
- ⑤ Push [TX Code Enter] to set the digit. The digit to the right will blink automatically.
 - When the 10-keypad* is used for setting, the digit to the right will blink automatically without pushing [TX Code CH Enter].
- ⑥ Repeat ④ and ⑤ to input all allowable digits.
- ⑦ Push [Call] or [PTT] to transmit the edited TX code.

*IC-F70DT/T or IC-F80DT/T only

3 BASIC OPERATION

◇ Individual ID code selection

(Digital mode operation only)

If the transceiver has [Individual] assigned to it, the indication can be toggled between the operating channel number (or name) and Individual ID code (or name). When the Individual ID code (or name) is displayed, [CH Up] or [CH Down] selects the desired Individual ID code.

- ① Push [Individual]— an Individual ID code (or name) appears.
- ② Push [CH Up] or [CH Down] to select the desired Individual ID code.
- ③ Push [PTT] to transmit the selected Individual ID code.
- ④ Push [Individual]— cancels the selected Individual ID code (return to the pre-set Talkgroup ID code in the channel.)

◇ Talkgroup ID code selection

(Digital mode operation only)

If the transceiver has [Talkgroup] assigned to it, the indication can be toggled between the operating channel number (or name) and Talkgroup ID code (or name). When the Talkgroup ID code (or name) is displayed, [CH Up] or [CH Down] selects the desired Talkgroup ID code.

- ① Push [Talkgroup]— a Talkgroup ID code (or name) appears.
- ② Push [CH Up] or [CH Down] to select the desired Talkgroup ID code.
- ③ Push [PTT] to transmit the selected Talkgroup ID code.
- ④ Change the channel— cancels the selected Talkgroup ID code (return to the pre-set Talkgroup ID code in the channel.)

◇ DTMF transmission

If the transceiver has [DTMF Autodial] assigned to it, the automatic DTMF transmission function is available. Up to 8 DTMF channels are available.

TO SELECT A TX CODE:

- ① Push [DTMF Autodial]— a DTMF channel appears.
- ② Push [CH Up] or [CH Down] to select the desired DTMF channel.
- ③ Push [DTMF Autodial] to transmit the DTMF code in the selected DTMF channel.

■ User set mode

User set mode is accessed at power ON and allows you to set seldom-changed settings. In this case you can “customize” the transceiver operation to suit your preferences and operating style.

Entering the user set mode:

- ① While pushing and holding [P1] and [P2], rotate [VOL] to turn the power ON. Then, push and hold [P0] to enter user set mode.

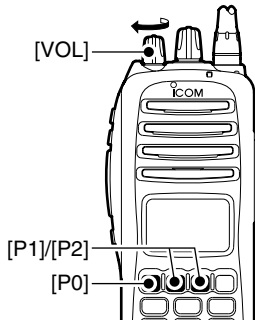

- ② Push [P0] several times to select the appropriate item. Then, push [Up] or [Down] to set the desired level/condition.

- Available set mode functions are **Backlight**, **LCD Contrast**, **Beep**, **Beep Level**, **SQL Level**, **AF Min Level**, **Mic Gain**, **Vox Gain**, **Vox Delay Battery Voltage** and **Signal Moni**.

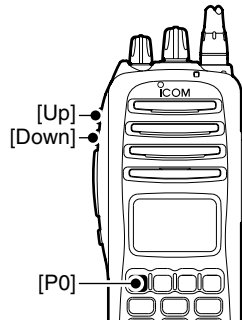

- ③ Rotate [VOL] to turn the power OFF to exit set mode.



NOTE: User set mode is also available via a programmable key. Please refer to p. 10 [User Set Mode] section.



3 BASIC OPERATION

■ Scrambler function

The voice scrambler function provides private communication between stations. The frequency inversion type is equipped to all versions, moreover, the optional Rolling or Non-rolling type can be available.

- ① Push [Scrambler] to turn the scrambler function ON.
 - “” appears.
- ② Push [Scrambler] again to turn the scrambler function OFF.
 - “” disappears.

■ Default setting

The following functions are assigned to each programmable key as the default. However, the assigned function can be changed by your dealer. Ask your dealer for details.

During digital mode operation, BIIS is not available.

⚡ **NOTE:** [TX Code Enter] must be assigned to a key.

[P0]; Call : Push to transmit a 5-tone/BIIS call when the selected channel is a 5-tone or BIIS channel.

- “CALL” is displayed on the key indicator.

[P1]; Digital : Push to select the call list ID/transmit message, or to display the receive message record for selection.

- “BIFN” is displayed on the key indicator. When this key is pushed, “BIFN” is inverted as “BIFN”.

[P3]; TX Code Enter : Push to enter the ID code edit mode directly for both 5-tone and BIIS.

- “TXCE” is displayed on the key indicator.

[P2]; Null : No function is assigned.

[MONI]; Moni(Audi) : Push this key after the communication to send a ‘Clear down’ signal during BIIS channel operation.

[Up]/[Down]; CH Up/Down : While in the standby condition, selects the operating channel. After pushing [Digital] or [TX Code CH Select], selects call list or TX code channel, respectively.

■ Receiving a call

◆ Individual call

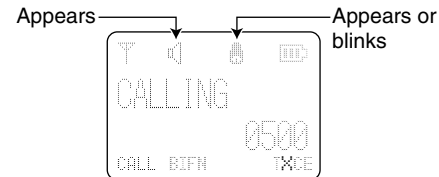

- ① When an individual call is received;
 - Beeps sound.
 - “📞” appears and the mute is released.
 - The programmed text message (e.g. “CALLING”) and the calling station ID (or text) is displayed when the indication mode is 2 lines.
 - The programmed text message (e.g. “CALLING”) and the calling station ID (or text) is displayed alternately when the indication mode is 1 line, depending on the setting.
 - “📞” appears or blinks depending on the setting.



- ② Push and hold [PTT], then speak into the microphone at a normal voice level.
 - TX indicator lights red.
- ③ Release [PTT] to return to receive.
 - BUSY indicator lights green while receiving a signal.
- ④ To finish the conversation, push [P4] (Moni(Audi)) to send the ‘Clear down’ signal.
 - Either station can send a ‘Clear down’ signal.
 - “CLR DOWN” is displayed for 2 sec. (approx.).
 - “📞” disappears and the transceiver returns to the standby condition.

4 BIIS OPERATION

◆ Group call

- ① When a group call is received;
 - Beeps sound.
 - “” appears and the mute is released.
 - The programmed text message (e.g.“GROUP”) and the calling station ID (or text) is displayed when the indication mode is 2 lines.
 - The programmed text message (e.g.“GROUP”) and the calling station ID (or text) is displayed alternately when the indication mode is 1 line, depending on the setting.
 - “” appears or blinks depending on the setting.

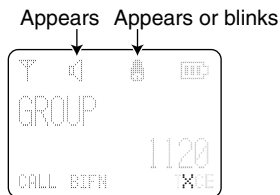

- ② Push and hold [PTT], then speak into the microphone at a normal voice level.
 - TX indicator lights red.

/// **NOTE:** Only one station is permitted to speak.
- ③ Release [PTT] to return to receive.
 - BUSY indicator lights green while receiving a signal.
- ④ To finish the conversation, push [MONITOR] (Moni(Audi)) to send the 'Clear down' signal.
 - Either station can send a 'Clear down' signal.
 - “CLR DOWN” is displayed for 2 sec. (approx.)
 - “” disappears and the transceiver returns to the standby condition.

◆ Displaying the received call record — Queue indication

The transceiver memorizes the calling station ID in the memory. Up to 3 calls can be memorized, and the oldest call record is erased when a 4th call is received. However, once the transceiver is powered OFF, the all records are cleared.

- ① Push and hold [P1] (Digital) for 1 sec.
 - Displays following indication.

When a record is available

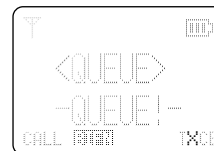

When no record is available



- ② Push [Up] or [Down] to select the desired call.
- ③ Push and hold [P1] (Digital) for 1 sec. again to return to the standby condition.
 - When no operation is performed for 30 sec., the transceiver returns to the standby condition automatically.

■ Transmitting a call

A total of 3 ways for code selection are available—selecting the call code from memory, entering the call code from the keypad and calling back from the queue channel record.

◇ Using call memory

- ① While in the standby condition, push [P1] (Digital) to enter the call code memory channel selection mode.
 - “” appears.

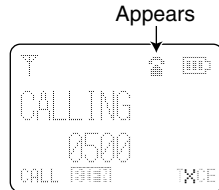

- ② Push [Up] or [Down] to select the desired call code.
- ③ Push [P0] (Call) or [PTT]* to call.
 - *PTT call can be made only when PTT call capability is permitted.

NOTE: When no answer back is received, the transceiver repeats the call 3 times (default) automatically, and “WAIT” is displayed during each call. However, an error beep sounds and “FAILED” is displayed when no answer back is received after the calls.

- ④ Push [PTT] to transmit; release to receive.
- ⑤ Push [P4] (Moni(Audi)) to send the ‘Clear down’ signal.

◇ Calling back from the queue channel

- ① While in the standby condition, push and hold [P1] (Digital) for 1 sec. to enter the queue memory channel selection mode.
- ② Push [Up] or [Down] to select the desired record.



- ③ Push [P0] (Call) or [PTT]* to call.
 - *PTT call can be made only when PTT call capability is permitted.

NOTE: When no answer back is received, the transceiver repeats the call 3 times (default) automatically, and “WAIT” is displayed during each call. However, an error beep sounds and “FAILED” is displayed when no answer back is received after the calls.
- ④ Push [PTT] to transmit; release to receive.
- ⑤ Push [P4] (Moni(Audi)) to send the ‘Clear down’ signal.

4 BIIS OPERATION

◆ Direct code entry

- ① While in the standby condition, push [P3] (TX Code Enter) to enter the TX code edit mode.
 - Code digit for editing blinks.

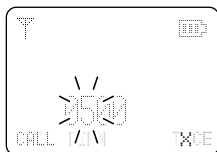

- ② Push [P3] (TX Code Enter) to select the desired digit to be edited.
 - Digit for editing differs according to the setting.
- ③ Set the desired digit using [CH Up]/[CH Down] or 10-key-pad*.
 - *IC-F70DT/T or IC-F80DT/T only
- ④ Push [P3] (TX Code Enter) to set the digit, then the digit to the right will blink automatically.
 - When the 10-keypad is used for setting, the digit to the right will blink automatically without pushing [P3] (TX Code Enter).
- ⑤ Repeat ③ and ④ to input all allowable digits.
- ⑥ Push [P0] (Call) or [PTT]* to call.

*PTT call can be made only when PTT call capability is permitted.

NOTE: When no answer back is received, the transceiver repeats the call 3 times (default) automatically, and "WAIT" is displayed during each call. However, an error beep sounds and "FAILED" is displayed when no answer back is received after the calls.

- ⑦ Push [PTT] to transmit; release to receive.
- ⑧ Push [P4] (Moni(Audi)) to send the 'Clear down' signal.

For your information

When the "UpDate" setting for the call code is enabled, the set code is overwritten into the call code memory.

■ Receiving a message

◇ Receiving a status message

- ① When a status message is received;
 - Beeps sound.
 - The calling station ID (or text) and the status message is displayed alternately when the indication mode is 1 line, depending on the setting.



- ② Push [P4] (Moni(Audi)) to return to the standby condition.

NOTE: Only the calling station ID (or text) is displayed (no message is displayed alternately) when the scroll timer is set to 'OFF.' In this case, push [Status Up]/[Status Down] to display the status message manually.

◇ Receiving an SDM (Short Data Message)

- ① When an SDM is received;
 - Beeps sound.
 - The calling station ID (or text) and the SDM is displayed alternately when the indication mode is 1 line, depending on the setting.



- ② When the received SDM includes more than 12 characters, the message scrolls automatically, when the automatic scroll function is activated.
 - Push [Status Up]/[Status Down] to scroll the message manually.



- ③ Push [P4] (Moni(Audi)) to return to the standby condition.

4 BIIS OPERATION

◆ Received message selection

The transceiver memorizes the received message in the memory. Up to 6 messages for status and SDM, or 95 character SDM's can be memorized. The oldest message is erased when the 7th message is received. However, once the transceiver is powered OFF, all messages are cleared.

- ① Push and hold [P1] (Digital) for 1 sec.
 - Displays queue memory.
- ② Push [P1] (Digital) momentarily.
 - Displays message memory.

When a message is available

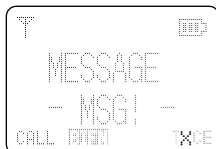

When no message is available



- ③ Push [Up] or [Down] to select the desired message.
 - When selecting the SDM that includes more than 12 characters, the message scrolls automatically when the automatic scroll function is activated.
 - Push [Status Up]/[Status Down] to scroll the message manually.
- ④ Push and hold [P1] (Digital) for 1 sec. again to return to the standby condition.
 - When no operation is performed for 30 sec., the transceiver returns to the standby condition automatically.

■ Transmitting a status

◇ General

The status message can be selected with the programmed text, and the message text is also displayed on the function display of the called station.

Up to 24 status types (1 to 24) are available, and the status messages 22 and 24 have designated meanings.

Status 22: Emergency*

Status 24: GPS request

*The status 22 can also be used as a normal status message by disabling the designated meaning. However, the status 24 is fixed.

The status call can be sent with both individual and group calls.

◇ Transmitting a status

- ① While in the standby condition, push [P1] (Digital), then push [Up] or [Down] to select the desired station/group code.
- ② Push [P1] (Digital) again, then push [Up] or [Down] to select the desired status message.

Or, you can select the desired status message using [Status Up]/[Status Down] key directly.



Status message is displayed.

- ③ Push [P0] (Call) or [PTT]* to transmit the status message to the selected station/group.
 - *PTT call can be made only when PTT call capability is permitted.
 - 2 beeps will sound and the transceiver returns to the standby condition automatically when the transmission is successful.

4 BIIS OPERATION

■ Transmitting an SDM (Short Data Message)

◇ General

The short data message, SDM, can be sent to an individual station or group stations. Also, 8 SDM memory channels are available and the messages can be edited via PC programming.

◇ Transmitting an SDM

- ① While in the standby condition, push [P1] (Digital), then push [Up] or [Down] or rotate [DIAL] to select the desired station/group code.
- ② Push [P1] (Digital) again, then push [Up] or [Down] to select the desired SDM.

Or, you can select the desired SDM using [Status Up]/[Status Down] key directly.



SDM is displayed.

- ③ Push [P0] (Call) or [PTT]* to transmit the SDM to the selected station/group.
*PTT call can be made only when PTT call capability is permitted.
•2 beeps will sound and the transceiver returns to the standby condition automatically when the transmission is successful.

◇ Programming an SDM memory (IC-F70DT/T or IC-F80DT/T only)

- ① During standby condition, push [P1] (Digital) twice, then push [Up] or [Down] to select the desired SDM to be edited.
- ② Push [*] or [#] to enter the message editing condition.
 - The first character blinks when [#] is pushed, the last character blinks when [*] is pushed.

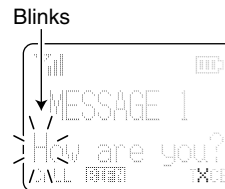

When [#] is pushed.

- ③ Push the appropriate digit key, [0] to [9], to enter the desired character.
 - See the table at right for the available characters.
 - Pushing [UP] also enters space, pushing [DOWN] deletes the selected character.
- ④ Push [#] to move the cursor to the right, push [*] to move the cursor to the left.
- ⑤ Repeat steps ③ and ④ to set the desired text message.
- ⑥ Push and hold [P1] (Digital) for 1 sec. to overwrite the set content into the memory.
 - Push [P1] (Digital) momentarily to cancel the editing and return to the original message indication.

•Available characters

Key	Characters
[0]	0 1 2 3 4 5 6 7 8 9 () < > []
[1]	(space) # * / + - = \ & % \$ @ ^
[2]	2 A B C a b c
[3]	3 D E F d e f
[4]	4 G H I g h i
[5]	5 J K L j k l
[6]	6 M N O m n o
[7]	7 P Q R S p q r s
[8]	8 T U V t u v
[9]	9 W X Y Z w x y z

NOTE: A decimal point can only be written with the CS-F70/F1700 CLONING SOFTWARE. Pre-programmed characters can be rewritten with the 10-keypad, except for the decimal point, as it is not included in the transceiver character list, and cannot be displayed again.

■ Position data transmission

When the optional cable (OPC-966) and a GPS receiver is connected to the transceiver, the position (longitude and latitude) data can be transmitted automatically.

Ask your dealer or system operator for connection details.

The position data is transmitted when;

- Status 24 message is received
*When the status 24 message, GPS request, is received.
- Fully automatic
When automatic position transmission is enabled, send the position data according to 'Time Marker' and 'Interval Timer' settings.
- PTT is released
When 'Send with Logoff' is enabled.
- Set the 'Log-In/Off' item as 'L-OFF.'
- After sending a status message
When 'Send with Status' is enabled.
- After sending an SDM
When 'Send with SDM' is enabled.
- After sending status 22 (Emergency)
When 'Send with Emergency' is enabled.

4 BIIS OPERATION

■ Printer connection

When the optional cable is connected to the transceiver, a printer can be connected to print out the received SDM content and the ID of the station who sent the message.

Ask your dealer or system operator for connection details.

■ Digital ANI

The own ID can be transmitted each time the PTT is pushed (log-in) or released (log-off) during individual or group call communications.

By receiving the ANI, the communication log can be recorded when using a PC dispatch application.

In addition, when using the ANI with log-in, the PTT side tone function can be used to inform you that the ID is sent and voice communication can be performed.

■ Auto emergency transmission

When [Emergency Single (Silent)] or [Emergency Repeat (Silent)] is pushed, an emergency signal is automatically transmitted for the specified time period.

The status 22 (Emergency) is sent to the selected ID station, and the position data is transmitted after the emergency signal when a GPS receiver is connected to the transceiver.

The emergency transmission is performed on the emergency channel, however, when no emergency channel is specified, the signal is transmitted on the previously selected channel.

There is no change in the function display or beep emission during automatic emergency transmission.

■ Stun function

When the specified ID, set as a killer ID, is received, the stun function is activated.

When the killer ID is received, the transceiver switches to the password required condition. Entering of the password via the keypad is necessary to operate the transceiver again in this case.

■ BIIS indication

The following indications are available for the BIIS operation on a BIIS channel.

- CONNECT : Individual/group call is successful.
OK : Message (status or SDM) transmission is successful.
FAILED : No answer back is received.
WAIT : Appears during retry of the call (2nd call).
CLR DOWN : End the communication.
BUSY : Operating channel is in the busy condition.

■ Priority A channel selection

When one of the following operations is performed, the transceiver selects the Priority A channel automatically.

Priority A is selected when;

- Clear down signal is received/transmitted
 - Set the 'Move to PrioA CH' item as 'Clear down.'
- Turning the power ON
 - The Priority A channel is selected each time the transceiver power is turned ON.
- Status call
 - The Priority A channel is selected when transmitting a status call.
 - Enable the 'Send Status on PrioA CH' item in the BIIS configuration.

■ Battery charging

Prior to using the transceiver for the first time, the battery pack must be fully charged for optimum life and operation.

/// **CAUTION:** To avoid damage to the transceiver, turn the power OFF while charging.

- Recommended temperature range for charging: +10°C to +40°C (+50°F to +104°F)
- Use the specified chargers (BC-119N and BC-121N). **NEVER** use another manufacturer's charger.
- Use the specified AC adapter. **NEVER** use another manufacturer's adapter.

Recommendation:

Charge the supplied battery pack for a maximum of up to 10 hours. Li-Ion batteries are different from Ni-Cd batteries in that it is not necessary to completely charge and discharge them to prolong the battery life. Therefore, charging the battery in intervals, and not for extended periods is recommended.

■ Battery caution

⚠ **DANGER** Charge the specified Icom batteries only. Only tested and approved for use with genuine Icom batteries. Fire and/or explosion may occur when a third party battery pack or counterfeit product is charged.

CAUTION! NEVER insert battery pack/transceiver (with the battery pack attached) in a wet or soiled condition into the charger. This may result in corrosion of the charger terminals or damage to the charger. The charger is not waterproof and water can easily get into it.

NEVER incinerate used battery packs. Internal battery gas may cause an explosion.

NEVER immerse the battery pack in water. If the battery pack becomes wet, be sure to wipe it dry **BEFORE** attaching it to the transceiver.

NEVER short the terminals of the battery pack. Also, current may flow into nearby metal objects, such as a necklace, etc. Therefore, be careful when carrying with, or placing near metal objects, carrying in handbags, etc.

AVOID leaving the battery pack in a fully charged, or completely discharged condition for long time. It causes shorter battery life. In case of leaving the battery pack unused for a long time, it must be kept safely after discharge, or use the battery until the battery indicator appears, then remove it from the transceiver.

If your battery pack seems to have no capacity even after being charged, fully charge the battery pack again. If the batteries still do not retain a charge (or very little), new battery pack must be purchased.

■ Optional battery chargers

◇ AD-110 installation

- ① Install the AD-110 desktop charger adapter into the holder space of the BC-119N/BC-121N.
- ② Connect the plugs of the BC-119N/BC-121N to the AD-110 desktop charger adapter with the connector, then install the adapter into the charger with the supplied screws.

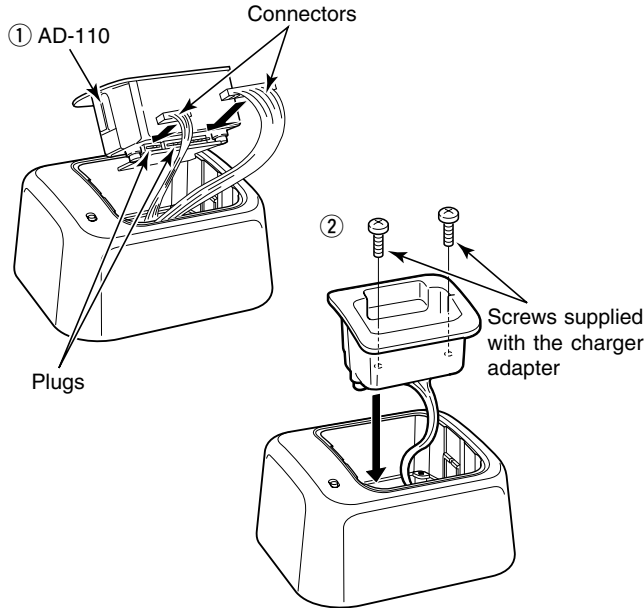

◇ Rapid charging with the BC-119N+AD-110

The optional BC-119N provides rapid charging of battery packs. The following items are additionally required.

- AD-110 charger adapter
- An AC adapter (may be supplied with BC-119N depending on version) or the DC power cable (OPC-515L/CP-17L).

- ① Insert the battery pack with/without the transceiver into the charger.
 - The charge indicator lights green.
- ② Charge the battery pack approx. 2.5 hours, depending on the remaining power condition.

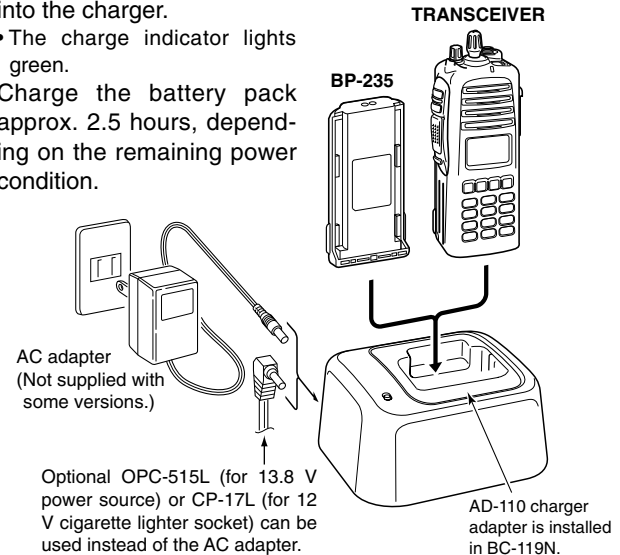

5 BATTERY CHARGING

◇ Rapid charging with the BC-121N+AD-110

The optional BC-121N allows up to 6 battery packs to be charged simultaneously. The following items are additionally required.

- Six AD-110 charger adapters
- An AC adapter (BC-124) or the DC power cable (OPC-656)

- ① Insert the battery pack with/without the transceiver into the charger.

- The charge indicator lights green.

- ② Charge the battery pack approx. 2.5 hours, depending on the remaining power condition.

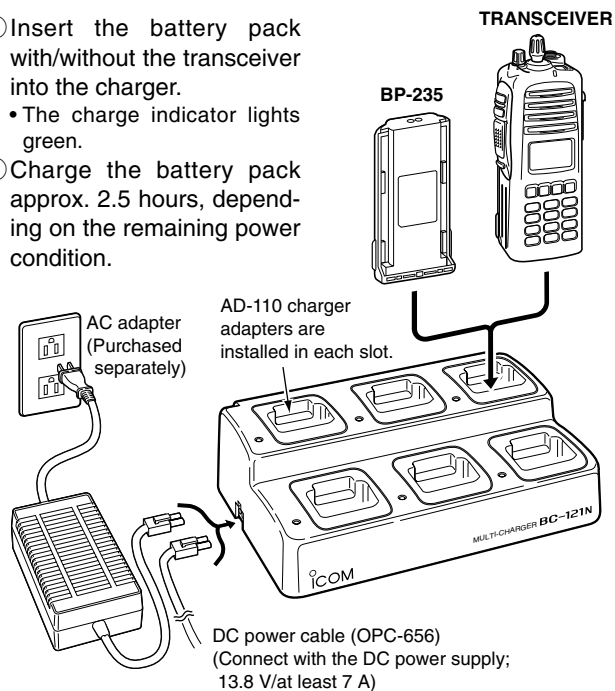

/// IMPORTANT!: Battery charging

Ensure the guide lobes on the battery pack are correctly aligned with the guide rails inside the charger adapter. (This illustration is described showing the BC-119N.)

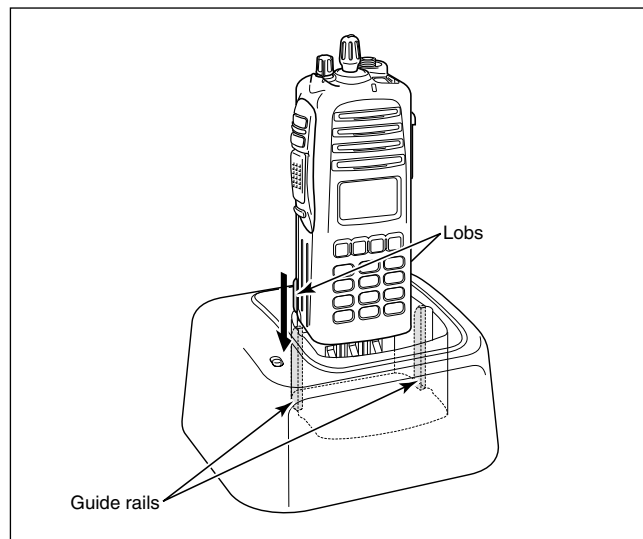

■ Optional battery case (BP-237)

When using the optional battery case attached to the transceiver, install 6 × AA (LR6) size alkaline batteries as illustrated at right.

- ① Hook your finger under the latch, and open the cover in the direction of the arrow (❶). (Fig.1)
- ② Then, install 6 × AA (LR6) size alkaline batteries. (Fig.2)
 - Install the alkaline batteries only.
 - Be sure to observe the correct polarity.
 - Do not pin the ribbon under the batteries.
- ③ Close the cover by fitting in the direction of the arrow (❷) first, then check the latch is in place (❸). (Fig.1)
 - Be sure the gasket is set correctly, and do not protrude from the battery case. (Fig.3)

CAUTION:

- When installing batteries, make sure they are all the same brand, type and capacity. Also, do not mix new and old batteries together.
- Keep battery contacts clean. It's a good idea to clean battery terminals once a week.

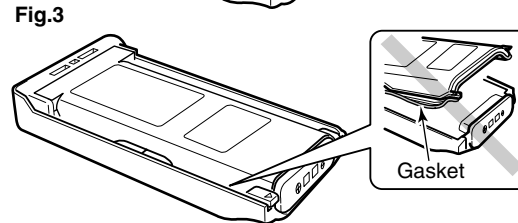
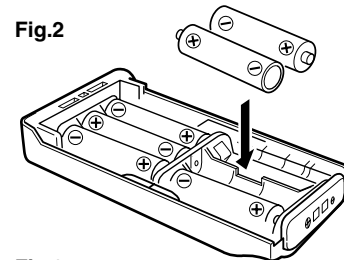
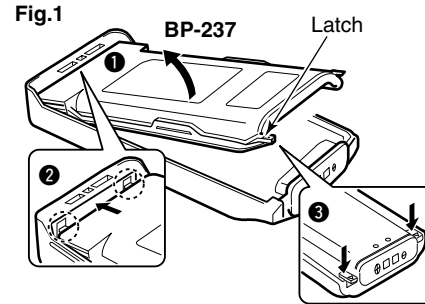

■ MB-93 contents

	Qty.
① Belt clip	1
② Base clip	1

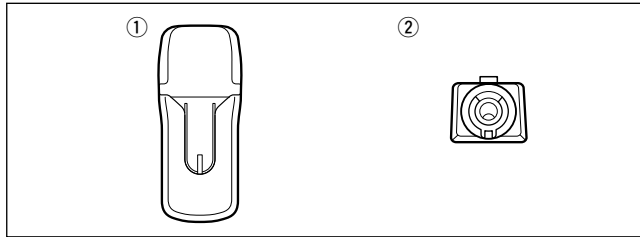

■ To attach

- ① Release the battery pack if it is attached. (p. 2)
- ② Slide the base clip in the direction of the arrow until the base clip is locked and makes a 'click' sound.

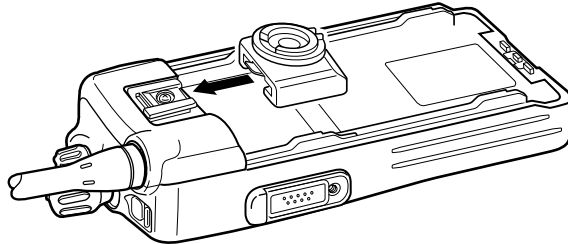

- ③ Clip the belt clip to a part of your belt. And insert the transceiver into the belt clip until the base clip inserted fully into the groove.

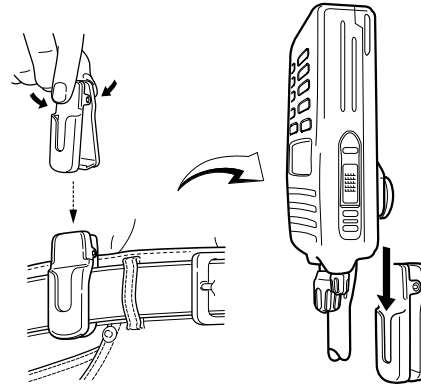

- ④ Once the transceiver is locked in place, it swivels as illustrated below.

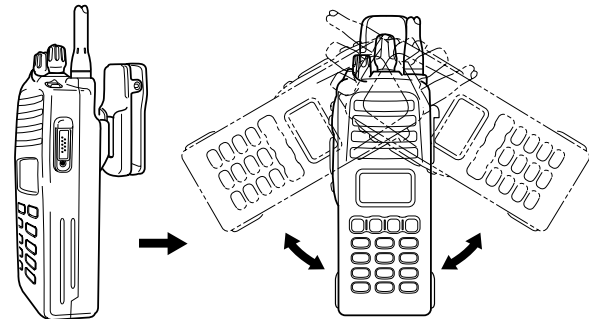

■ To detach

- ① Turn the transceiver upside down in the direction of the arrow and pull out from the belt clip.

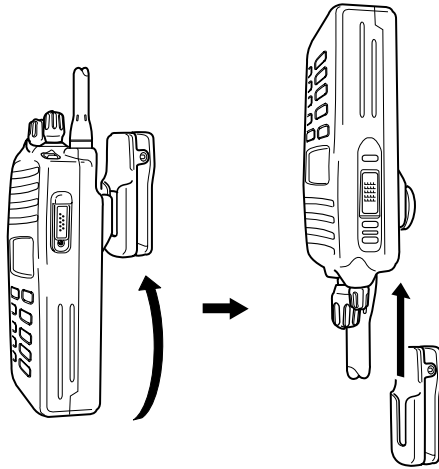

- ② Release the battery pack if it is attached. (p. 2)
 ③ Pinch the clip (①), and slide the base clip in the direction of the arrow (②).

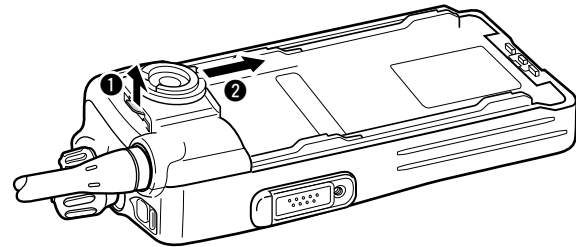

CAUTION!

HOLD THE TRANSCEIVER TIGHTLY, WHEN HANGING OR DETACHING THE TRANSCEIVER FROM THE BELT CLIP.

Otherwise the transceiver may not be attached to the holder or swivel properly if the transceiver is accidentally dropped and the base clip is scratched or damaged.

Optional HM-138 description

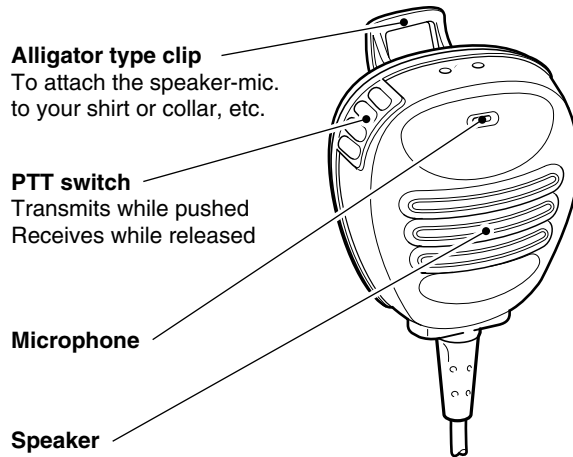

NEVER immerse the connector in water. If the connector becomes wet, be sure to dry it **BEFORE** attaching it to the transceiver.

NOTE: The microphone is located at the top of the speaker-microphone, as shown in the diagram above. To maximize the readability of your transmitted signal (voice), hold the microphone approx. 5 to 10 cm (2 to 4 inches) from your mouth, and speak in a normal voice level.

Attachment

Attach the connector of the speaker-microphone into the [SP/MIC] connector on the transceiver and tighten the screw.

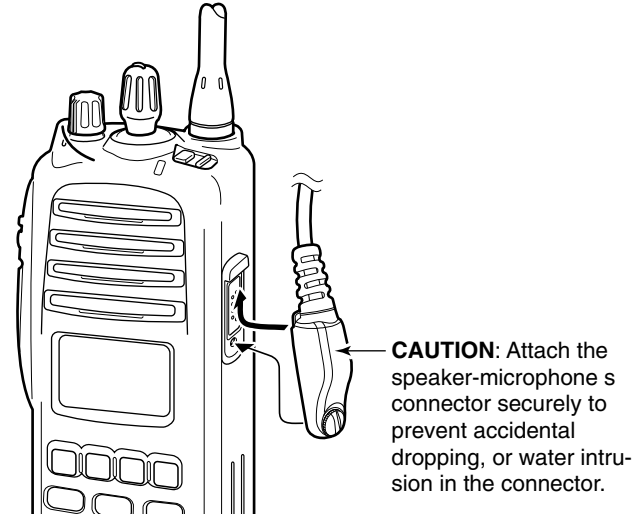

IMPORTANT: KEEP the connector cover attached to the transceiver when the speaker-microphone is not in use. Water will not get into the transceiver even if the cover is not attached, however, the terminals (pins) will become rusty, or the transceiver will function abnormally if the connector becomes wet.

◇ BATTERY PACK

• **BP-235** Li-Ion BATTERY PACK

7.4 V/1600 mAh Li-Ion battery pack, allows more than 8 hours operation. The same as supplied with the transceiver. The BP-235 meets IPX waterproof specification grade 7.

• **BP-236** Li-Ion BATTERY PACK

7.4 V/2400 mAh Li-Ion battery pack, allows more than 12 hours operation.

The BP-236 meets IPX waterproof specification grade 7.

• **BP-237** BATTERY CASE

Battery case for 6 × AA (LR6) alkaline cells.

The BP-237 meets IPX waterproof specification grade 4.

◇ CHARGERS

• **BC-119N** DESKTOP CHARGER + **AD-110** CHARGER ADAPTER + **BC-145A** AC ADAPTER

For rapid charging of battery packs. An AC adapter is supplied with the charger depending on versions. Charging time: approx. 2.5 hours when BP-235 is attached.

• **BC-121N** MULTI-CHARGER + **AD-110** CHARGER ADAPTER (6 pcs.) + **BC-124** AC ADAPTER

For rapid charging of up to 6 battery packs (six AD-110's are required) simultaneously. An AC adapter should be purchased separately. Charging time: approx. 2.5 hours when BP-235 is attached.

◇ BELT CLIPS

• **MB-93** SWIVEL BELT CLIP

• **MB-94** BELT CLIP

The same as supplied with the transceiver.

• **MB-96N/96F** LEATHER BELT HANGER

◇ OPTIONAL UNITS

• **UT-109 (#02)/UT-110 (#02)** SCRAMBLER UNITS

Non-rolling type (UT-109)/Rolling type (UT-110) voice scrambler unit provides higher communication security.

• **UT-111** LTR TRUNKING BOARD

Provides trunking operation.

◇ DC CABLES

• **CP-17L** CIGARETTE LIGHTER CABLE

Allows charging of the battery pack through a 12 V cigarette lighter socket. (For BC-119N)

• **OPC-515L/OPC-656** DC POWER CABLES

Allows charging of the battery pack using a 13.8 V power source instead of the AC adapter.

OPC-515L: For BC-119N

OPC-656 : For BC-121N

• **OPC-966** INTERFACE CABLE

Provides advanced operation, such as printer, GPS connection for position data transmission capabilities during BIIS operation.

9 OPTIONS

◇ OTHER OPTIONS

• **HM-138** SPEAKER-MICROPHONE

Full-sized waterproof (IPX grade 7; 1m/30 min.) speaker-microphone including alligator type clip to attach to your shirt or collar, etc.

• **HS-94/HS-95/HS-97** HEADSET + **VS-1SC** VOX/PTT CASE

HS-94: Ear-hook type

HS-95: Neck-arm type

HS-97: Throat microphone

VS-1SC: VOX/PTT switch box for hands-free operation, etc.

• **AD-98FSC** ANTENNA CONNECTOR CONVERTER

Allows you to connect an external antenna with BNC connector.

• **FA-SC25V/FA-SC55V/FA-SC25U/FA-SC57U/FA-SC72U**

FLEXIBLE ANTENNAS

FA-SC25V: 136–155 MHz

FA-SC55V: 146–174 MHz

FA-SC25U: 400–430 MHz

FA-SC57U: 440–470 MHz

FA-SC72U: 470–520 MHz

• **FA-SC56VS/FA-SC57VS/FA-SC73US** STUBBY ANTENNAS

FA-SC56VS: 150–162 MHz

FA-SC57VS: 160–174 MHz

FA-SC73US: 450–490 MHz

Some options may not available in some countries. Please ask your dealer for details.

◇ About VS-1SC VOX/PTT CASE

The VS-1SC is a VOX/PTT unit for Icom handheld transceivers, and allows you hands-free operation.

An optional headset (HS-94, etc.) is required for operation.

- The VOX (Voice Operated Transmission) function starts transmission without pushing PTT switch when you speak into the microphone; then, automatically returns to receive when you stop speaking.

Features

- 9-pin Spring-plug type head SP/MIC plug is equipped
- Water resistant construction
- Durable construction
- Equipped with a PTT switch and revolving clip

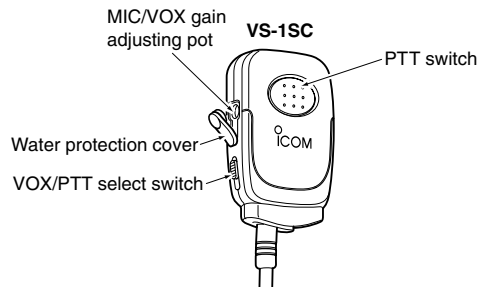

VOX gain and delay adjustment

- ① Attach the connector of the VS-1SC into the [SP/MIC] connector on the transceiver and tighten the screw.
 - Toggle the toggle switch to [VOX].
- ② Enter user set mode. (p. 17)
- ③ Push [P0] several times to select the “VOX Gain” or “VOX Delay” items. Then, push [Up] or [Down] to set the desired level/condition.
- ④ Rotate [VOL] to turn the power OFF to exit set mode.

• VOX Gain

The VOX sensitivity level can be adjusted from OFF or 1 to 6 (more sensitive).



VOX function is OFF

[Up]
Push
[Down]



VOX gain level 3
(default)

• VOX Delay

The VOX delay time can be set from 0.5 to 3.0 sec. (0.5 sec. step) for a convenient interval before returning to receive.



0.5 sec (min.)
(default)

[Up]
Push
[Down]



3.0 sec (max.)

NOTE: MIC/VOX gain can be adjusted via the Adjusting pot using a thin screw driver.

10 SAFETY TRAINING INFORMATION



Your Icom radio generates RF electromagnetic energy during transmit mode. This radio is designed for and classified as “Occupational Use Only”, meaning it must be used only during the course of employment by individuals aware of the hazards, and the ways to minimize such

hazards. This radio is NOT intended for use by the “General Population” in an uncontrolled environment.

This radio has been tested and complies with the FCC RF exposure limits for “Occupational Use Only”. In addition, your Icom radio complies with the following Standards and Guidelines with regard to RF energy and electromagnetic energy levels and evaluation of such levels for exposure to humans:

- FCC OET Bulletin 65 Edition 97-01 Supplement C, Evaluating Compliance with FCC Guidelines for Human Exposure to Radio Frequency Electromagnetic Fields.
- American National Standards Institute (C95.1-1992), IEEE Standard for Safety Levels with Respect to Human Exposure to Radio Frequency Electromagnetic Fields, 3 kHz to 300 GHz.
- American National Standards Institute (C95.3-1992), IEEE Recommended Practice for the Measurement of Potentially Hazardous Electromagnetic Fields— RF and Microwave.
- The accessories (antennas, batteries, belt clips, speaker-microphone, etc. that is listed on Pages 39–40) are authorized for use with this product. Use of accessories other than those specified may result in RF exposure levels exceeding the FCC requirements for wireless RF exposure.



CAUTION

To ensure that your exposure to RF electromagnetic energy is within the FCC allowable limits for occupational use, always adhere to the following guidelines:

- **DO NOT** operate the radio without a proper antenna attached, as this may damage the radio and may also cause you to exceed FCC RF exposure limits. A proper antenna is the antenna supplied with this radio by the manufacturer or antenna specifically authorized by the manufacturer for use with this radio.
- **DO NOT** transmit for more than 50% of total radio use time (“50% duty cycle”). Transmitting more than 50% of the time can cause FCC RF exposure compliance requirements to be exceeded. The radio is transmitting when the TX indicator lights red. You can cause the radio to transmit by pressing the “PTT” switch or VOX function.
- **ALWAYS keep** the antenna at least 2.5 cm (1 inch) away from the body when transmitting and only use the Icom belt-clips listed on page 39 when attaching the radio to your belt, etc., to ensure FCC RF exposure compliance requirements are not exceeded. To provide the recipients of your transmission the best sound quality, hold the antenna at least 5 cm (2 inches) from your mouth, and slightly off to one side.

The information listed above provides the user with the information needed to make him or her aware of RF exposure, and what to do to assure that this radio operates with the FCC RF exposure limits of this radio.

Electromagnetic Interference/Compatibility

During transmissions, your Icom radio generates RF energy that can possibly cause interference with other devices or systems. To avoid such interference, turn off the radio in areas where signs are posted to do so. **DO NOT** operate the transmitter in areas that are sensitive to electromagnetic radiation such as hospitals, aircraft, and blasting sites.

Occupational/Controlled Use

The radio transmitter is used in situations in which persons are exposed as consequence of their employment provided those persons are fully aware of the potential for exposure and can exercise control over their exposure.

Count on us!

A-6418D-1US
Printed in Japan
© 2004 Icom Inc.

Icom Inc.
1-1-32 Kamiminami, Hirano-ku, Osaka 547-0003, Japan