

**KENWOOD**

# NEXEDGE NX-900/ NX-901



800MHz DIGITAL TRANSCEIVER  
900MHz DIGITAL TRANSCEIVER

## INSTRUCTION MANUAL

ÉMETTEUR-RÉCEPTEUR NUMÉRIQUE 800MHz  
ÉMETTEUR-RÉCEPTEUR NUMÉRIQUE 900MHz

## MODE D'EMPLOI

TRANSCPTOR DIGITAL 800MHz  
TRANSCPTOR DIGITAL 900MHz

## MANUAL DE INSTRUCCIONES

JVC KENWOOD Corporation

© B62-2384-00 (K)  
09 08 07 06 05 04 03 02 01 00

800MHz DIGITAL TRANSCEIVER  
900MHz DIGITAL TRANSCEIVER

# NX-900/NX-901

## INSTRUCTION MANUAL

---

JVC KENWOOD Corporation

ENGLISH

## Terminal Description

### Microphone Jack

Pin NO.	Pin Name	Description	Specification	I/O	Notes
1	BLC	Mic key backlight control	CMOS	O	
2	SB	Power Output	13.6 V	O	
3	GND	Ground	Ground	-	
4	PTT/TXD	PTT Input/Serial Data Output	High Impedance/ CMOS	I/O	
5	ME	MIC Ground	Ground	-	
6	MIC	MIC Signal Input	600 $\Omega$	I	
7	HOOK/RXD	Hook Detection/ Serial Data Input	High Impedance	I	
8	DM	MIC Data Detection	High Impedance	I/O	

### ACC (D-SUB 25 Pin Connector)

Pin NO.	Pin Name	Description	Specification	I/O	Notes
2	RXD1	Serial Data Input	RS-232C compatible	I	
3	TXD1	Serial Data Output	RS-232C compatible	O	
5	DI	Data Input	CMOS	I	input : 0.5 V p-p (Typ.) Data Rate : 9600 bps High Impedance
6	MI2	MIC Signal Input	600 $\Omega$	I	
7	GND	Ground	Ground	-	
9	TXD2	Serial Data Output	TTL	O	
10	RXD2	Serial Data Input	TTL	I	
11	GND	Ground	Ground	-	
18	GND	Ground	Ground	-	
25	ME	MIC Ground	Ground	-	

### Antenna Connector

Impedance is 50  $\Omega$ .

## THANK YOU

We are grateful you have chosen **Kenwood** for your personal mobile applications. We believe this easy-to-use transceiver will provide dependable communications to keep personnel operating at peak efficiency.

**Kenwood** transceivers incorporate the latest in advanced technology. As a result, we feel strongly that you will be pleased with the quality and features of this product.

## NOTICES TO THE USER

- ◆ Government law prohibits the operation of unlicensed transmitters within the territories under government control.
- ◆ Illegal operation is punishable by fine and/or imprisonment.
- ◆ Refer service to qualified technicians only.

**SAFETY:** It is important that the operator is aware of, and understands, hazards common to the operation of any transceiver.



### WARNING

- ◆ **EXPLOSIVE ATMOSPHERES (GASES, DUST, FUMES, etc.)**  
Turn OFF your transceiver while taking on fuel or while parked in gasoline service stations. Do not carry spare fuel containers in the trunk of your vehicle if your transceiver is mounted in the trunk area.
- ◆ **INJURY FROM RADIO FREQUENCY TRANSMISSIONS**  
Do not operate your transceiver when somebody is either standing near to or touching the antenna, to avoid the possibility of radio frequency burns or related physical injury.
- ◆ **DYNAMITE BLASTING CAPS**  
Operating the transceiver within 500 feet (150 m) of dynamite blasting caps may cause them to explode. Turn OFF your transceiver when in an area where blasting is in progress, or where "TURN OFF TWO-WAY RADIO" signs have been posted. If you are transporting blasting caps in your vehicle, make sure they are carried in a closed metal box with a padded interior. Do not transmit while the caps are being placed into or removed from the container.

## One or more of the following statements may be applicable:

### FCC WARNING

This equipment generates or uses radio frequency energy. Changes or modifications to this equipment may cause harmful interference unless the modifications are expressly approved in the instruction manual. The user could lose the authority to operate this equipment if an unauthorized change or modification is made.

### INFORMATION TO THE DIGITAL DEVICE USER REQUIRED BY THE FCC

This equipment has been tested and found to comply with the limits for a Class B digital device, pursuant to Part 15 of the FCC Rules. These limits are designed to provide reasonable protection against harmful interference in a residential installation.

This equipment generates, uses and can generate radio frequency energy and, if not installed and used in accordance with the instructions, may cause harmful interference to radio communications. However, there is no guarantee that the interference will not occur in a particular installation. If this equipment does cause harmful interference to radio or television reception, which can be determined by turning the equipment off and on, the user is encouraged to try to correct the interference by one or more of the following measures:

- Reorient or relocate the receiving antenna.
- Increase the separation between the equipment and receiver.
- Connect the equipment to an outlet on a circuit different from that to which the receiver is connected.
- Consult the dealer for technical assistance.

## PRECAUTIONS

Observe the following precautions to prevent fire, personal injury, and transceiver damage.

- Do not attempt to configure the transceiver while driving; it is too dangerous.
- Do not disassemble or modify the transceiver for any reason.
- Do not expose the transceiver to long periods of direct sunlight, nor place it near heating appliances.
- If an abnormal odor or smoke is detected coming from the transceiver, switch the transceiver power off immediately, and contact your **Kenwood** dealer.
- Use of the transceiver while you are driving may be against traffic laws. Please check and observe the vehicle regulations in your area.
- Do not use options not specified by **Kenwood**.



### CAUTION

- ◆ The transceiver operates in **12 V** negative ground systems only! Check the battery polarity and voltage of the vehicle before installing the transceiver.
- ◆ Use only a **Kenwood** optional DC power cable.
- ◆ Do not cut and/or remove the fuse holder on the DC power cable.



### WARNING

For passenger safety, install the transceiver securely using an optional mounting bracket and screw set so the transceiver will not break loose in the event of a collision.

# CONTENTS

<b>UNPACKING AND CHECKING EQUIPMENT .....</b>	<b>1</b>
<b>SUPPLIED ACCESSORIES .....</b>	<b>1</b>
<b>PREPARATION .....</b>	<b>2</b>
<b>TOOLS REQUIRED .....</b>	<b>2</b>
<b>POWER CABLE CONNECTION .....</b>	<b>2</b>
<b>INSTALLING THE TRANSCEIVER .....</b>	<b>3</b>
<b>GETTING ACQUAINTED.....</b>	<b>4</b>
<b>FRONT PANEL .....</b>	<b>4</b>
<b>DISPLAY.....</b>	<b>5</b>
<b>REAR PANEL .....</b>	<b>6</b>
<b>PROGRAMMABLE FUNCTIONS.....</b>	<b>7</b>
<b>BASIC OPERATIONS.....</b>	<b>9</b>
<b>SWITCHING POWER ON/OFF .....</b>	<b>9</b>
<b>ADJUSTING THE VOLUME.....</b>	<b>9</b>
<b>SELECTING A ZONE AND CHANNEL/GROUP ID.....</b>	<b>9</b>
<b>TRANSMITTING.....</b>	<b>10</b>
<b>RECEIVING.....</b>	<b>11</b>
<b>MENU MODE .....</b>	<b>12</b>
<b>MENU ACCESS.....</b>	<b>12</b>
<b>MENU CONFIGURATION .....</b>	<b>12</b>
<b>CHARACTER ENTRY .....</b>	<b>14</b>
<b>SCAN .....</b>	<b>15</b>
<b>TEMPORARY CHANNEL LOCKOUT.....</b>	<b>15</b>
<b>PRIORITY SCAN .....</b>	<b>15</b>
<b>SCAN REVERT.....</b>	<b>16</b>
<b>SCAN DELETE/ADD.....</b>	<b>16</b>
<b>PRIORITY-CHANNEL SELECT.....</b>	<b>16</b>
<b>FleetSync: ALPHANUMERIC 2-WAY PAGING FUNCTION.....</b>	<b>17</b>
<b>SELCALL (SELECTIVE CALLING).....</b>	<b>17</b>
<b>STATUS MESSAGE .....</b>	<b>18</b>
<b>SHORT MESSAGES.....</b>	<b>19</b>
<b>LONG MESSAGES .....</b>	<b>19</b>

GPS REPORT.....	19
<b>DTMF (DUAL TONE MULTI FREQUENCY) CALLS.....</b>	<b>20</b>
<b>MAKING A DTMF CALL .....</b>	<b>20</b>
<b>AUTODIAL.....</b>	<b>20</b>
<b>STUN CODE.....</b>	<b>20</b>
<b>TRUNKING CALLS.....</b>	<b>21</b>
<b>MAKING A TELEPHONE CALL .....</b>	<b>21</b>
<b>RECEIVING A TELEPHONE CALL .....</b>	<b>21</b>
<b>EMERGENCY CALLS .....</b>	<b>22</b>
<b>SCRAMBLER.....</b>	<b>23</b>
<b>SECURE (ENCRYPTED) TRANSMISSION.....</b>	<b>23</b>
<b>SIGNALING.....</b>	<b>24</b>
<b>QUIET TALK (QT)/ DIGITAL QUIET TALK (DQT) .....</b>	<b>24</b>
<b>RADIO ACCESS NUMBER (RAN) .....</b>	<b>25</b>
<b>OPTIONAL SIGNALING .....</b>	<b>25</b>
<b>ADVANCED OPERATIONS .....</b>	<b>26</b>
<b>CLOCK.....</b>	<b>26</b>
<b>LCD BRIGHTNESS.....</b>	<b>26</b>
<b>HORN ALERT .....</b>	<b>26</b>
<b>PUBLIC ADDRESS (PA).....</b>	<b>27</b>
<b>BACKGROUND OPERATIONS .....</b>	<b>28</b>
<b>TIME-OUT TIMER (TOT) .....</b>	<b>28</b>
<b>SIGNAL STRENGTH INDICATOR .....</b>	<b>28</b>
<b>COMPANDER .....</b>	<b>28</b>
<b>BUSY CHANNEL LOCKOUT (BCL).....</b>	<b>29</b>
<b>CONTROL CHANNEL HUNT .....</b>	<b>29</b>
<b>PTT ID.....</b>	<b>29</b>
<b>VGS-1 OPTIONAL VOICE GUIDE &amp; STORAGE UNIT.....</b>	<b>30</b>
<b>VOICE RECORDER.....</b>	<b>30</b>
<b>VOICE GUIDE .....</b>	<b>31</b>

# UNPACKING AND CHECKING EQUIPMENT

**Note:** The following unpacking instructions are for use by your **Kenwood** dealer, an authorized **Kenwood** service facility, or the factory.

Carefully unpack the transceiver. We recommend that you identify the items listed in the following table before discarding the packing material. If any items are missing or have been damaged during shipment, file a claim with the carrier immediately.

## SUPPLIED ACCESSORIES

• Microphone (with cable) . . . . .	1
• Microphone hanger (with 4 x 16 mm self-tapping screws) . . . . .	1
• DC power cable . . . . .	1
• Fuse (15 A) . . . . .	2
• Mounting bracket . . . . .	1
• Screw set	
• 5 x 16 mm self-tapping screw . . . . .	4
• Hex-headed screw with washer . . . . .	4
• Spring washer . . . . .	4
• Flat washer . . . . .	4
• Instruction manual . . . . .	1



# PREPARATION



## WARNING

Various electronic equipment in your vehicle may malfunction if they are not properly protected from the radio frequency energy which is present while transmitting. Electronic fuel injection, anti-skid braking, and cruise control systems are typical examples of equipment that may malfunction. If your vehicle contains such equipment, consult the dealer for the make of vehicle and enlist his/her aid in determining if they will perform normally while transmitting.

**Note:** The following preparation instructions are for use by your **Kenwood** dealer, an authorized **Kenwood** service facility, or the factory.

## TOOLS REQUIRED

**Note:** Before installing the transceiver, always check how far the mounting screws will extend below the mounting surface. When drilling mounting holes, be careful not to damage vehicle wiring or parts.

The following tools are required for installing the transceiver:

- 1/4 inch (6 mm) or larger electric drill
- 5/32 inch (4.2 mm) drill bit for the self-tapping screws used to mount the optional mounting bracket
- Circle cutters

## POWER CABLE CONNECTION



## CAUTION

- ◆ The transceiver operates in **12 V** negative ground systems only! Check the battery polarity and voltage of the vehicle before installing the transceiver.
- ◆ Use only a **Kenwood** optional DC power cable.
- ◆ Do not cut and/or remove the fuse holder on the DC power cable.

- 1 Check for an existing hole, conveniently located in the firewall, where a power cable can be passed through. If no hole exists, use a circle cutter to drill the firewall, then install a rubber grommet.
- 2 Run the two power cable leads through the firewall and into the engine compartment, from the passenger compartment.
- 3 Connect the red lead to the positive (+) battery terminal and the black lead to the negative (-) battery terminal.
  - Locate the fuse as close to the battery as possible.
- 4 Coil and secure the surplus cable with a retaining band.
  - Be sure to leave enough slack in the cables so the transceiver can be removed for servicing while keeping the power applied.

## INSTALLING THE TRANSCEIVER



### WARNING

For passenger safety, install the transceiver securely using an optional mounting bracket and screw set so the transceiver will not break loose in the event of a collision.

- 1 Mark the position of the holes in the dash by using the mounting bracket as a template. Drill the holes, then attach the mounting bracket using self-tapping screws.
  - Be sure to mount the transceiver in a location where the controls are within easy reach of the user and where there is sufficient space at the rear of the transceiver for cable connections.
- 2 Connect the antenna and power cable to the transceiver.
- 3 Slide the transceiver into the mounting bracket and secure it using hex-headed screws.
- 4 Mount a microphone hanger in a location where it will be within easy reach of the user.
  - The microphone and microphone cable should be mounted in a location where it will not interfere with the safe operation of the vehicle.



### CAUTION

When replacing the fuse in the DC power cable, be sure to replace it with a fuse of the same value. Never replace a fuse with a fuse that has a higher value.

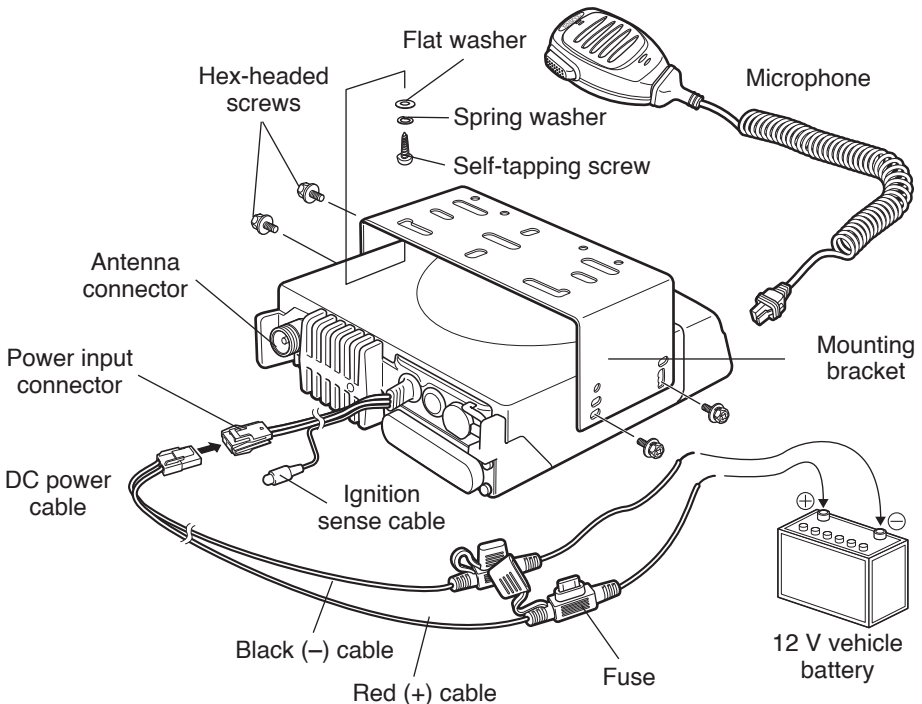

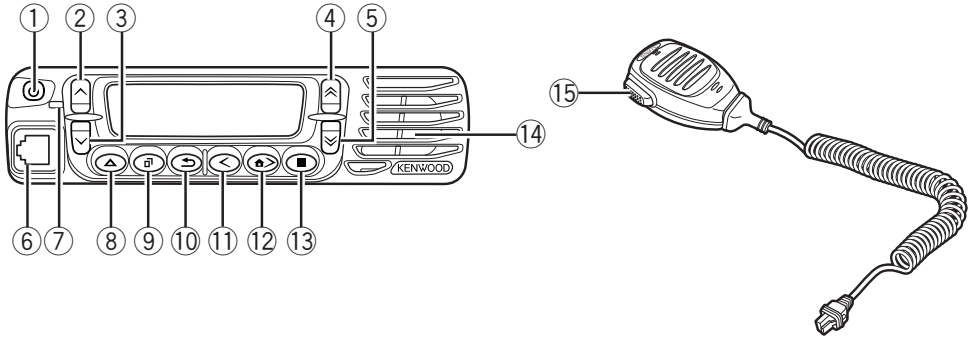

# GETTING ACQUAINTED

## FRONT PANEL

















- ① **⏻ (power) switch**  
Press and hold for approximately 1 second to switch the transceiver power ON and OFF.
- ② **⏮ key**  
Press to activate its programmable function {page 7}. The default setting is Volume Up.
- ③ **⏭ key**  
Press to activate its programmable function {page 7}. The default setting is Volume Down.
- ④ **⏮ key**  
Press to activate its programmable function {page 7}. The default setting is Channel/Group ID Up.
- ⑤ **⏭ key**  
Press to activate its programmable function {page 7}. The default setting is Channel/Group ID Down.
- ⑥ **Microphone jack**  
Insert the microphone plug into this jack.
- ⑦ **LED indicator**  
Lights red while transmitting. Lights green while receiving a call.
- ⑧ **⏮ key**  
Press to activate its programmable function {page 7}. The default setting is None (no function).
- ⑨ **⏮ key**  
Press to activate its programmable function {page 7}. The default setting is Menu mode.
- ⑩ **⏮ key**  
Press to activate its programmable function {page 7}. The default setting is Squelch Off Momentary.

- ⑪  **key**  
Press to activate its programmable function {page 7}. The default setting is Zone Down.
- ⑫  **key**  
Press to activate its programmable function {page 7}. The default setting is Zone Up.
- ⑬  **key**  
Press to activate its programmable function {page 7}. The default setting is None (no function).
- ⑭ **Speaker**  
Internal speaker
- ⑮ **PTT (Push-to-Talk) switch**  
Press and hold this switch then, speak into the microphone to call a station.

## DISPLAY



Indicator	Description
	Appears when the Monitor or Squelch Off function is activated.
	Blinks when signaling of an incoming call matches the Optional Signaling set up on your transceiver.
	Appears when the current zone (left icon) or CH/GID (right icon) is added to the scanning sequence.
	Appears when you are using Scan mode. Blinks while paused at a channel.
	Appears when there is a message stored in the transceiver memory. Blinks when a new message has arrived.
	Appears when the current channel is programmed as a Priority channel. “P1” represents Priority channel 1. “P2” represents Priority channel 2. “P” represents Priority channels 1 and 2.
	Appears when the Operator Selectable Tone (OST) function is activated.
	A Telephone ID call is being received in LTR Trunking mode. Blinks during AutoTelephone search in LTR Trunking mode. (The location of this icon is the same as the OST icon.)
	Appears when the Talk Around function is activated.

Indicator	Description
	<p>The number of bars indicates the strength of incoming signals. The antenna plus 3 bars represents a strong signal while only the antenna represents a weak signal. No antenna means no signal is present. On NXDN Trunking channels, the antenna indicator flashes when you are out of range.</p>
	<p>Appears when the Scrambler/ Encryption function is activated.</p>
	<p>Appears when the Auto Recording function on the VGS-1 option is activated.</p>
	<p>Appears when the Auto Reply Message is on. (The location of this icon is the same as the Auto Recording icon.)</p>
	<p>Appears when the AUX A function is activated.</p>
	<p>Appears when the AUX B function is activated.</p>

## REAR PANEL

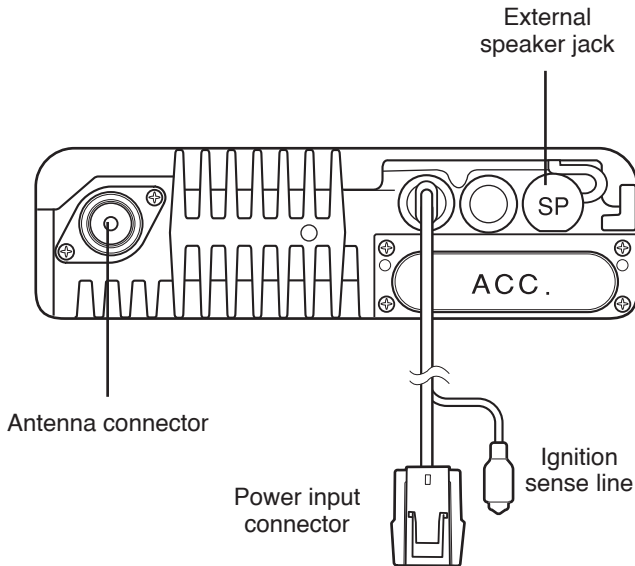

# PROGRAMMABLE FUNCTIONS

Following is a list of available programmable functions. Please contact your dealer for further details on those functions which have been programmed on your transceiver.

Conv: Channels set up for Conventional Operation

Trunk: Channels set up for Trunking Operation

✓: Available

N/A: Not Available

Programmable Function	Analog		NXDN (Digital)	
	Conv	LTR Trunk	Conv	Trunk
Auto Reply Message <sup>1</sup>	✓	✓	✓	✓
Auto Telephone	N/A	✓	N/A	N/A
Autodial	✓	✓	✓	✓
Autodial Programming	✓	✓	✓	✓
AUX A	✓	✓	✓	✓
AUX B	✓	✓	✓	✓
Broadcast	N/A	N/A	N/A	✓
Call 1 ~ 6	✓	✓	✓	✓
CH/GID Down	✓	✓	✓	✓
Channel Entry	✓	✓	✓	✓
CH/GID Up	✓	✓	✓	✓
CH/GID Recall	✓	✓	✓	✓
Clock	✓	✓	✓	✓
Clock Adjustment	✓	✓	✓	✓
CW Message	N/A	N/A	✓	N/A
Direct CH/GID 1 ~ 5	✓	✓	✓	✓
Direct CH/GID Select 1 ~ 5	✓	✓	✓	✓
Display Format	✓	✓	✓	✓
Emergency <sup>2</sup>	✓	✓	✓	✓
Fixed Volume	✓	✓	✓	✓
Forced Search	N/A	N/A	N/A	✓
Function	✓	✓	✓	✓
GPS Position Display	✓	✓	✓	✓
Group (NXDN)	N/A	N/A	✓	N/A
Group + SDM (NXDN)	N/A	N/A	✓	✓
Group + Status (NXDN)	N/A	N/A	✓	✓
Home CH/GID	✓	✓	✓	✓
Home CH/GID Select	✓	✓	✓	✓
Horn Alert	✓	✓	✓	✓
Individual (NXDN)	N/A	N/A	✓	✓
Individual + SDM (NXDN)	N/A	N/A	✓	✓



Programmable Function	Analog		NXDN (Digital)	
	Conv	LTR Trunk	Conv	Trunk
Individual + Status (NXDN)	N/A	N/A	✓	✓
LCD Brightness	✓	✓	✓	✓
Lone Worker	✓	✓	✓	✓
Maintenance	✓	✓	✓	✓
Menu	✓	✓	✓	✓
Monitor	✓	✓	✓	N/A
Monitor Momentary	✓	✓	✓	N/A
OST (Operator Selectable Tone)	✓	N/A	N/A	N/A
Playback <sup>1</sup>	✓	✓	✓	✓
Priority-channel Select	✓	N/A	✓	N/A
Public Address	✓	✓	✓	✓
Scan	✓	✓	✓	✓
Scan Delete/Add	✓	✓	✓	✓
Scrambler/Encryption	✓	✓	✓	✓
Scrambler/Encryption Code	✓	✓	✓	✓
SDM (FleetSync/ NXDN)	✓	✓	✓	✓
Selcall (FleetSync)	✓	✓	N/A	N/A
Selcall + SDM (FleetSync)	✓	✓	N/A	N/A
Selcall + Status (FleetSync)	✓	✓	N/A	N/A
Send the GPS data	✓	✓	✓	✓
Site Lock	N/A	N/A	N/A	✓
Site Up	N/A	N/A	N/A	✓
Site Down	N/A	N/A	N/A	✓
Squelch Level	✓	N/A	N/A	N/A
Squelch Off	✓	N/A	N/A	N/A
Squelch Off Momentary	✓	N/A	N/A	N/A
Stack	✓	✓	✓	✓
Status (FleetSync/ NXDN)	✓	✓	✓	✓
Talk Around	✓	✓	✓	N/A
Telephone Disconnect	N/A	✓	N/A	N/A
Transceiver Password	✓	✓	✓	✓
Voice Memo <sup>1</sup>	✓	✓	✓	✓
Volume Down	✓	✓	✓	✓
Volume Up	✓	✓	✓	✓
Zone Delete/Add	✓	✓	✓	✓
Zone Down	✓	✓	✓	✓
Zone Up	✓	✓	✓	✓

<sup>1</sup> Auto Reply Message, Playback, and Voice Memo are available only if the VGS-1 optional board has been installed.

<sup>2</sup> Emergency can be programmed only on the ☺ key and an optional auxiliary switch, such as an emergency foot switch.







# BASIC OPERATIONS

## SWITCHING POWER ON/OFF

Press and hold the  switch for approximately 1 second to turn the transceiver power ON. Press and hold the  switch again to turn the transceiver OFF.

## ■ Transceiver Password

If the transceiver is password protected, “PASSWORD” will appear on the display when the power is turned ON. To unlock the transceiver, enter the correct password:

- 1 Select a character using the  and  keys.
  - If you are using a microphone keypad, you can enter the password by directly pressing the DTMF keys instead.
- 2 Press the  key to enter the selected character.
  - This step is unnecessary when using a keypad.
- 3 Repeat steps 1 and 2 to enter the entire password.
  - Press the  key or microphone # key to delete an incorrectly entered character. Press and hold the  key or microphone # key to delete all characters.
- 4 Press the  key or microphone \* key to confirm the entry.
  - If you enter an incorrect password, an error tone sounds and the transceiver remains locked.
  - The password can contain a maximum of 6 digits.

## ADJUSTING THE VOLUME

Press the keys programmed with **Volume Up/ Volume Down** to adjust the volume level.

## SELECTING A ZONE AND CHANNEL/GROUP ID

Select the desired zone using the keys programmed as **Zone Up/ Zone Down**. Each zone contains a group of channels.

Select the desired channel/group ID using the keys programmed as **CH/GID Up / CH/GID Down**. Each channel/group ID is programmed with settings for transmitting and receiving.

Names can be programmed for zones and channels/group IDs. Each name can contain up to 14 characters.

- You can toggle the display between the zone and channel/group ID names and number by pressing the key programmed as Display Format, or by accessing the Display Format function through the Menu {page 12}.





## TRANSMITTING

For Trunking channels, refer to “Making Group Calls (Digital)” and “Making Individual Calls (Digital)”, below.

- 1 Select the desired zone and channel using the **Zone Up/ Zone Down** or **CH/GID Up/ CH/GID Down** keys.
- 2 Press the key programmed as **Monitor** or **Squelch Off** to check whether or not the channel is free.
  - If the channel is busy, wait until it becomes free.
- 3 Press the microphone **PTT** switch and speak into the microphone. Release the **PTT** switch to receive.
  - The LED indicator lights red while transmitting and green while receiving a signal. This indicator can also be disabled by your dealer.
  - For best sound quality, hold the microphone approximately 1.5 inches (3 ~ 4 cm) from your mouth.



### ■ Making Group Calls (Digital)

If a key has been programmed with **Group** or **Group + Status**, you can select a group ID from the list to make a call to those parties. To select a group ID:

- 1 Press the key programmed as **Group** or **Group + Status**.
- 2 Press the /  keys to select a group ID/name from the list that has been pre-entered into your transceiver.
  - The target group ID/name appears on the display.
  - If you are using a microphone keypad, you can enter a unit ID by pressing the DTMF keypad.
- 3 Press and hold the microphone **PTT** switch to make the call.
  - Speak into the microphone as you would during a normal transmission.

### ■ Making Individual Calls (Digital)

If a key has been programmed with **Individual** or **Individual + Status**, you can make calls to specified persons.

- 1 Press the key programmed as **Individual** or **Individual + Status**.
- 2 Press the /  keys to select a unit ID/name from the list that has been pre-entered into your transceiver.
  - The target unit ID/name appears on the display.
  - If you are using a microphone keypad, you can enter a unit ID by pressing the DTMF keypad.
- 3 Press and hold the microphone **PTT** switch to make the call.
  - Speak into the microphone as you would during a normal transmission.

## RECEIVING

- 1 Select the desired zone and channel using the **Zone Up/ Zone Down** or **CH/GID Up/ CH/GID Down** keys. (If the Scan function has been programmed, you can switch it on or off as desired.)
- 2 When you hear a caller's voice, readjust the volume as necessary.
  - If signaling has been programmed on the selected channel, you will hear a call only if the signaling tone matches the tone set up on your transceiver.

---

**Note:** Signaling allows your transceiver to code your calls. This will prevent you from listening to unwanted calls. It does not make calls private, it only prevents them from being heard by transceivers set with a different signaling code. Refer to "SIGNALING" on page 24 for details.

---

### ■ Receiving Group Calls (Digital)

When you receive a group call on a Conventional channel and the received group ID matches the ID set up on your transceiver, you can hear the caller's voice.

When on a Trunking channel, if the Group ID of a received call matches your Group ID, you will hear the call.

- Readjust the volume as necessary.

### ■ Receiving Individual Calls (Digital)









When you receive an individual call on a Conventional channel, a ringing tone will sound and the display will show the caller's ID. To respond to the call, press and hold the microphone **PTT** switch and speak into the transceiver as you would during a normal transmission.

When you receive an individual call on a Trunking channel, a ringing tone will sound and the caller's ID will appear on the display. After receiving the call, you can respond to the call by pressing and holding the microphone **PTT** switch and speaking into the microphone as you would during a normal transmission.

# MENU MODE

Many functions on this transceiver are selected or configured through the Menu instead of physical controls. Once you become familiar with the Menu system, you will appreciate the versatility it offers.

## MENU ACCESS

- 1 Press the key programmed as **Menu**.
- 2 Press the / keys to select your desired Menu item.
  - If you are using a microphone keypad, you can directly enter a Menu number to skip to that Menu.
- 3 Press the  key to set up the selected Menu item.
- 4 Press the / keys to select your desired setting.
  - For settings with more than 1 level, repeat steps 3 and 4.
- 5 Press the  key to set the selected setting and exit Menu mode.
  - Press the  key at any time to return to the previous display.
  - Press the  key at any time to exit Menu mode.

## MENU CONFIGURATION

Some transceiver keys may already be programmed with functions listed in the Menu. Those functions can be accessed directly by pressing the key, or by accessing the Menu. All other functions can still be accessed using the transceiver Menu. The following table lists all the available Menu items.



Menu	Description
AUTO REPLY MSG	Auto Reply Message ON/OFF
AUTO TELEPHONE	Auto Telephone
AUTO DIAL	Autodial Mode
AUTO DIAL PROG	Autodial Programming Mode
AUX A	AUX A ON/OFF
AUX B	AUX B ON/OFF
BROADCAST	Broadcast ON/OFF
CLOCK	Clock ON/OFF
CLOCK ADJUST	Clock Adjustment mode
DIRECT CH1 SEL	Direct CH/GID 1 ~ 5 Select
DISP FORMAT	Display Format ON/OFF
EXT MIC TYPE	External Microphone Type mode
FIXED VOLUME	Fixed Volume



<b>Menu</b>	<b>Description</b>
FORCED SEARCH	Forced Search
GPS POS DISP	GPS Position Display mode
GROUP	Group mode
GROUP+STATUS	Group + Status mode
GROUP+SDM	Group + SDM mode
HOME CH SEL	Home CH/GID Select
HORN ALERT	Horn Alert ON/OFF
INDIVIDUAL	Individual mode
INDIV+STATUS	Individual + Status mode
INDIV+SDM	Individual + SDM mode
LCD BRIGHTNESS	LCD Brightness level
LONE WORKER	Lone Worker ON/OFF
MAINTENANCE	Maintenance Display Mode
MONITOR	Monitor ON/OFF
OST	OST ON/OFF
OST LIST	OST mode
PLAYBACK	Playback mode
PRI CH SEL	Priority Channel Select mode
RX AUDIO EQ	RX Audio Equalizer mode
RX AGC	RX Audio Gain Control mode
RX LOW CUT	RX Low Cut mode
PUBLIC ADDRESS	Public Address System ON/OFF
SCAN	Scan ON/OFF
SCAN DEL/ADD	Scan Delete/Add
SCRAM/ENCRYP	Scrambler/Encryption ON/OFF
SCRAM CODE	Scrambler Code mode
SELCALL	Selcall mode
SELCALL+STATUS	Selcall + Status mode
SELCALL+SDM	Selcall + SDM mode
SEND GPS DATA	Transmit your GPS data
SITE LOCK	Site Lock ON/OFF
SITE No.	Display Site Number
SITE	Site Select Mode

Menu	Description
SQUELCH LEVEL	Squelch Level mode
SQUELCH OFF	Squelch Off ON/OFF
STACK	Stack mode
STATUS	Status mode
SHORT MESSAGE	Short Message mode
TALK AROUND	Talk Around ON/OFF
TX AUDIO EQ	TX Audio Equalizer mode
TX AGC	TX Audio Gain Control mode
TX NOISE SUPPR	TX Noise Suppressor mode
PASSWORD	Transceiver Password mode
VOICE MEMO	Voice Memo mode
ZONE DEL/ADD	Zone Delete/Add

## CHARACTER ENTRY

There are 2 methods available for entering characters:

1) pressing the   keys and 2) using the microphone keypad.

When pressing the   keys, the displayed character entry cycles through A ~ Z, 0 ~ 9 and a space (default settings).

You can also assign a character to an optional key and later press that key to recall the assigned character: A ~ Z, a ~ z, 0 ~ 9, or a space and characters.

When using the microphone keypad, you can enter characters as shown in the table below:

DTMF Key	Default Character Cycle
1	1
2	A > B > C > 2
3	D > E > F > 3
4	G > H > I > 4
5	J > K > L > 5
6	M > N > O > 6
7	P > Q > R > S > 7
8	T > U > V > 8
9	W > X > Y > Z > 9
0	[space] > 0

# SCAN

Scan is useful for monitoring signals on the transceiver channels. While scanning, the transceiver checks for a signal on each channel and only stops on a channel if a signal is present.

To begin scanning, press the key programmed as **Scan**.

- The  icon appears on the display.
- The channels included in the scan list are scanned.
- When a signal is detected on a channel, Scan pauses on that channel. The transceiver will remain on the busy channel until the signal is no longer present. When the signal “drops out”, the transceiver will remain on the channel momentarily before Scan resumes. This delay time is programmed by your dealer. If a signal is received during the delay time, the transceiver will remain on the same channel.

To stop scanning, press the **Scan** key again.

---

**Note:** In order for Scan to operate, there must be at least 2 channels added to the scanning sequence. If there are less channels than this, Scan will not operate.

---

## TEMPORARY CHANNEL LOCKOUT

If a key is programmed with the **Scan Delete/Add** function, each channel can be locked out of the scan sequence manually.

During scan, you can temporarily remove specific channels from the scanning sequence by selecting them and pressing the **Scan Delete/Add** key.

- The  icon (right side) no longer appears on the display for that channel.
- The channel is no longer scanned. However, when scanning is ended and restarted, the channels will reset and the channel will again be in the scanning sequence.

## PRIORITY SCAN

A Priority channel must be programmed in order for Priority Scan to function.

When using a single Priority channel, the transceiver will automatically change to the Priority channel when a call is received on it, even if a call is being received on a normal channel.

When using dual Priority channels, Priority channel 1 is given precedence over Priority channel 2. So, if a call is received on Priority channel 1 while a call is already on Priority channel 2, the transceiver will automatically change to Priority channel 1.

- “” appears on the display when the channel is Priority channel 1, “” appears when the channel is Priority channel 2, and “” appears when the channel is both Priority channel 1 and 2.

## SCAN REVERT

The Scan Revert channel is the channel selected when you press the microphone **PTT** switch to transmit during scan. Your dealer can program one of the following Scan Revert channels:

- **Last Called + Selected:** The last channel on which you received a call is assigned as the new revert channel. If the channel has been changed, the newly selected channel is assigned as the new revert channel.
- **Selected:** The last channel selected is assigned as the new revert channel.
- **Selected + Talkback:** If the channel has been changed, the newly selected channel is assigned as the new revert channel. The transceiver “talks back” on the current channel.
- **Priority 1/ Priority 2:** If your dealer has programmed a Priority channel (either Priority 1 or Priority 2), this channel is the revert zone and channel.
- **Priority 1 + Talkback/ Priority2 + Talkback:** If your dealer has programmed a Priority channel (either Priority 1 or Priority 2), this channel is the revert zone and channel. The transceiver “talks back” on the current receive channel.



## SCAN DELETE/ADD

You can add and remove zones and/or channels/group IDs to and from your scan list.

- 1 Select your desired zone and/or channel/group ID.
- 2 Press the key programmed as **Zone Delete/Add** (to add/remove zones) or **Scan Delete/Add** (to add/remove channels/group IDs).
  - You can also press and hold the key programmed as **Scan Delete/Add** to add/remove zones.

## PRIORITY-CHANNEL SELECT

If the Priority channel has been set as Operator Selectable by your dealer, you are also able to reprogram the Priority mode.

- 1 Select your desired zone and channel.
- 2 Press the key programmed as **Priority-channel Select**, or press and hold the key programmed as **Scan**.
  - A list of channel types appears on the display.
- 3 Press the / keys to select the channel type for your current channel.
  - You can set the channel as “NORMAL”, “PRIORITY 1”, “PRIORITY 2”, or “PRIORITY 1&2”.
- 4 Press the  key to save the setting and exit Priority-channel Select Mode.

# FleetSync: ALPHANUMERIC 2-WAY PAGING FUNCTION

FleetSync is an Alphanumeric 2-way Paging Function, and is a protocol owned by **JVC KENWOOD** Corporation. FleetSync enables a variety of paging functions on your transceiver, some of which depend on dealer programming.

Your dealer can set up either FleetSync or FleetSync II on your transceiver. Transceivers set up with FleetSync can communicate with other transceivers that have been set up with FleetSync. Likewise, transceivers set up with FleetSync II can communicate with other transceivers set up with FleetSync II. However, transceivers set up with FleetSync cannot communicate with transceivers that have been set up with FleetSync II, and vice-versa.

---







**Note:** This function is available only in analog operation.

---

## SELCALL (SELECTIVE CALLING)

A Selcall is a voice call to a particular station or to a group of stations.

### ■ Transmitting

- 1 Select your desired zone and channel.
- 2 Press the key programmed as **Selcall** or **Selcall + Status** to enter Selcall mode.
- 3 Press the / keys to select the ID of the station you want to call.
  - If Manual Dialing is enabled, you can enter the station ID by using the microphone keypad, or by using the / keys. When using the / keys, cycle through the digits to select a digit, then press the  key to set the digit and move the cursor to the right. Repeat this process until the entire ID is entered.
- 4 Press the microphone **PTT** switch and begin your conversation.

### ■ Receiving

An alert tone will sound and the transceiver will automatically enter Selcall Mode.

The calling station's ID will appear when a Selcall is received. When the call station's ID appears on the display, you can respond to the call by pressing the microphone **PTT** switch and speaking into the microphone.



## ■ Identification Codes

An ID code is a combination of a 3-digit Fleet number and a 4-digit ID number. Each transceiver must have its own Fleet and ID number.

- Enter a Fleet number (100 ~ 349) to make a fleet call.
- Enter an ID number (1000 ~ 4999) to make an individual call in your fleet.
- Enter a Group ID (which is programmed in the FPU) to make a group call.
- Enter a Fleet number followed by an ID number to make an individual call in your desired fleet (Inter-fleet call).
- Select “ALL” Fleet and “ALL” ID to make a call to all units (Broadcast call).
- Select “ALL” Fleet and enter an ID number to make a call to the selected ID in all fleets (Supervisor call).

---

### Note:















- ◆ Broadcast and Supervisor calls are programmed functions that cannot be made with a keypad.
  - ◆ The ID range may be limited by programming.
- 

## STATUS MESSAGE

You can send and receive 2-digit Status messages which may be decided in your talk group. Messages can contain up to 16 alphanumeric characters. Status messages range from 10 to 99 (80 ~ 99 are reserved for special messages).

A maximum of 15 received messages can be stored in the stack memory of your transceiver. These saved messages can be reviewed after reception. Depending on your dealer settings, when the stack memory is full, either the oldest message will be erased when a new message is received or the new message will not be stored in the stack memory. The  icon lights when a message is stored in the stack memory.

## ■ Transmitting

- 1 Select your desired zone and channel.
- 2 Press the key programmed as **Status** to enter Status mode or **Selcall + Status** to enter Selcall mode.
  - When using the **Status** key to enter Status mode, the target Fleet/ ID is fixed and cannot be selected. Skip to step 5 to continue.
- 3 In Selcall mode, press the   keys to select the ID of the station you want to call.
  - If Manual Dialing is enabled, you can enter the station ID by using the microphone keypad, or by using the   keys. When using the   keys, cycle through the digits to select a digit, then press the  key to set the digit and move the cursor to the right. Repeat this process until the entire ID is entered.
- 4 Press the  key enter Status mode.
- 5 Press the   keys to select the status ID you want to transmit.
  - If Manual Dialing is enabled, you can enter the station ID by using the microphone keypad, or by using the   keys. When using the   keys, cycle through the digits to select a digit, then press the  key to set the digit and move the cursor to the right. Repeat this process until the entire ID is entered.









- 6 Press the microphone **PTT** switch or the  key to initiate the Status call.
  - “<<COMPLETE>>” is displayed when the call has been successfully transmitted.

## ■ Receiving

The  icon will flash and a calling ID or text message will appear when a Status call is received.

Press any key to return to normal operation.

## ■ Reviewing Messages in the Stack Memory

- 1 Press the key programmed as **Stack**, or press and hold the key programmed as **Selcall**, **Status**, or **Selcall + Status** to enter Stack mode.
  - The last received message is displayed with the message number.
- 2 Press the / keys to select the desired message.
  - Message types are identified as follows:  
I: Caller ID  
S: Status Message  
M: Short Message
  - You can change the displayed information by pressing and holding the  key for 1 second. The display cycles as follows:  
ID Name > Status/Short Message > CH/GID > Time Stamp > ID Name ...
- 3 Press the  key to return to normal operation.
  - To delete the selected message, press the  key or microphone # key. To confirm the deletion, press the  key or microphone \* key.
  - To delete all messages, press and hold the  key or microphone # key for 1 second. To confirm the deletion, press the  key or microphone \* key.

## SHORT MESSAGES

To send a short message, you must connect the transceiver to a PC. Ask your dealer for details.

- Short messages can contain a maximum of 48 characters.
- Received short messages are displayed the same as Status messages and are stored in the same stack memory. A combined maximum of 15 Status calls and short messages can be stored in the stack memory.

## LONG MESSAGES

To send and receive long messages, you must connect the transceiver to a PC. Ask your dealer for details.

- Long messages can contain a maximum of 4096 characters.

## GPS REPORT

To send your location data, you must first connect a GPS unit to the transceiver. GPS data can be manually transmitted by pressing the key programmed as **Send the GPS data**, or by accessing the Send the GPS data function through the Menu {page 12}. If set up by your dealer, GPS data may be automatically transmitted at a preset time interval.

# DTMF (DUAL TONE MULTI FREQUENCY) CALLS

## MAKING A DTMF CALL

### ■ Manual Dialing (Microphone Keypad Only)



- 1 Press and hold the microphone **PTT** switch.
- 2 Enter the desired digits using the microphone keypad.
  - The corresponding DTMF tones sound each time you press a key.
  - If you release the microphone **PTT** switch, transmit mode will end even if the complete number has not been sent.

### ■ Keypad Auto PTT (Microphone Keypad Only)

If your dealer has activated the Keypad Auto PTT function, simply press the microphone keys to make the call.

- The DTMF code will be sent automatically when you press a key.

### ■ Store & Send

- 1 Press the key programmed as **Autodial**.
- 2 Enter the desired digits using the microphone keypad.
  - The digits appear on the display as you enter them.
  - Alternatively, you can enter digits by using the /  keys {page 14}.
  - You can enter up to 30 digits before transmitting.
- 3 After entering the complete number, press the microphone **PTT** switch or the  key to transmit.



---

**Note:** If you switch the power OFF before transmitting the number, the number will be cleared.

---

## AUTODIAL

Autodial allows you to quickly call DTMF numbers that have been programmed onto your transceiver.

- 1 Press the key programmed as **Autodial**, or access the Autodial function through the Menu {page 12}.
  - The first entry in the Autodial list appears on the display.
- 2 Press the /  keys or enter the appropriate DTMF number (01 ~ 32) to select your desired Autodial list number.
  - The stored entry appears on the display.
- 3 Press the microphone **PTT** switch to make the call.

## STUN CODE

This function is used when a transceiver is stolen or lost. When the transceiver receives a call containing a stun code, either transmit mode will be disabled, or both receive mode and transmit mode will be disabled. The stun code is cancelled when the transceiver receives a call with a revive code.



# TRUNKING CALLS

## MAKING A TELEPHONE CALL

### ■ Manual Dialing (Analog)

- 1 Select your desired zone and telephone group ID.
- 2 Press the microphone **PTT** switch to start the call.
- 3 Enter your desired number using the microphone keys.

### ■ Selecting a Number from the List

- 1 Select your desired zone and telephone group ID.
- 2 Press the key programmed as **Autodial**.
  - The last called unit appears on the display.
- 3 Press the   keys to select your desired list number.
- 4 Press the microphone **PTT** switch to start the call.

## RECEIVING A TELEPHONE CALL

When a call is received, press and hold the microphone **PTT** switch to speak, and release it to receive.

- Only one person can speak at a time.

# EMERGENCY CALLS

If your transceiver has been programmed with the Emergency function, you can make emergency calls.

---

**Note:** Only the  key and an optional auxiliary switch, such as an emergency foot switch, can be programmed with the Emergency function.

---

**1** Press and hold the key programmed as **Emergency**.

- Depending on the delay time programmed into your transceiver, the length of time it takes to switch to Emergency mode will vary.
- When the transceiver enters Emergency mode, the transceiver will change to the Emergency channel and begin transmitting based on how the transceiver is set up by your dealer. Transmit periods are also set by your dealer.

**2** To exit Emergency mode, press and hold the **Emergency** key again.

- If the Emergency mode completes a preset number of cycles, Emergency mode will automatically end and the transceiver will return to the zone and channel that was in use before Emergency mode was entered.

---

**Note:**

- ◆ Your dealer can set the transceiver to emit a tone when transmitting in Emergency mode.
  - ◆ Your dealer can set the transceiver to emit tones and received signals as normal or mute the speaker during Emergency operation.
-

# SCRAMBLER

---

**Note:** Ask your dealer for details concerning the Voice Scrambler board.

---

## SECURE (ENCRYPTED) TRANSMISSION

Press the key programmed as **Scrambler/ Encryption**, or access the Scrambler function through the Menu {page 12}, to switch the transceiver to secure (encrypted) transmission.

- The  icon appears when the Scrambler function is turned ON.
- Pressing the microphone **PTT** switch after the Scrambler function has been turned ON encrypts the transmitted signal.

# SIGNALING

## QUIET TALK (QT)/ DIGITAL QUIET TALK (DQT)





Your dealer may have programmed QT or DQT signaling on your transceiver channels. A QT tone/ DQT code is a sub-audible tone/code which allows you to ignore (not hear) calls from other parties who are using the same channel.

When a channel is set up with a QT tone or DQT code, squelch will only open when a call containing a matching tone or code is received. Likewise, signals that you transmit will only be heard by parties whose QT/ DQT signaling matches your transceiver.

If a call containing a different tone or code is made on the same channel you are using, squelch will not open and you will not hear the call. This allows you to ignore (not hear) these calls. Although it may seem like you have your own private channel while using QT/ DQT, other parties can still hear your calls if they set up their transceiver with the same tone or code.

## ■ Operator Selectable Tone (OST)

If a key has been programmed with **OST**, you can reprogram the QT/DQT settings on each of your channels.

- 1 Select your desired channel.
- 2 Press and hold the key programmed as **OST** for 1 second.
  - The  icon appears on the display.
- 3 Press the /  keys to select your desired tone or code. (Your dealer can set up to 40 tones/codes.)
- 4 Press the  key to save your new setting.

After selecting and setting up your desired tone or code, the OST function is activated. When you have finished operating using OST, press the **OST** key to turn the OST function OFF.

## **RADIO ACCESS NUMBER (RAN)**

RAN is a new signaling system designed only for digital radio communications. The operation is the same as the analog QT/ DQT signaling.

When a channel is set up with a RAN, squelch will only open when a call containing a matching RAN is received. Likewise, signals that you transmit will only be heard by parties whose RAN signaling matches your transceiver.

If a call containing a different RAN is made on the same channel you are using, squelch will not open and you will not hear the call. This allows you to ignore (not hear) these calls.

## **OPTIONAL SIGNALING**

Your dealer may also program several types of option signaling for your transceiver channels.

**DTMF Signaling:** DTMF Signaling opens the squelch only when the transceiver receives a call containing a matching DTMF code. Refer to “DTMF (DUAL TONE MULTI FREQUENCY) CALLS” on page 20.

**FleetSync Signaling:** Refer to “SELCALL (SELECTIVE CALLING)” on page 17.

**NXDN ID Signaling:** NXDN ID is an optional signaling system available only for digital communications.



# ADVANCED OPERATIONS

## CLOCK

If activated by your dealer, your transceiver can track the time with its built-in clock. The time will display momentarily when the transceiver power is turned ON. Additionally, you can view the clock any time by pressing the key programmed as **Clock**.





---

**Note:** Removing the transceiver power for extended periods will cause the clock time to clear.

---

### ■ Clock Adjustment

To set the time:

- 1 Press the key programmed as **Clock Adjustment**.
  - The current time setting appears.
- 2 Press the /  keys to increase or decrease the year setting.
- 3 Press the  key to set the year and cycle to the month setting.
- 4 Repeat steps 2 and 3 to set the day, hour, and minute.
- 5 Press the  key to exit Clock Adjustment mode.
  - You can press  at any time to exit Clock Adjustment mode.

## LCD BRIGHTNESS

The LCD backlight can be turned off or set to low or high levels. To cycle through the brightness settings, press the key programmed as **LCD Brightness**.

- Each press of **LCD Brightness** cycles the brightness level from high to low to off, and then back to high.

## HORN ALERT

To use the Horn Alert function, your dealer must install an optional unit. When a call is received that matches the optional signaling set up on your transceiver, Horn Alert causes the vehicle horn or some other external alert to sound. This function notifies you of a received call when you are away from your vehicle.

To toggle Horn Alert ON and OFF, press the key programmed as **Horn Alert** or access the Horn Alert function through the Menu {page 12}.

- HA momentarily appears on the display when Horn Alert is active.

## **PUBLIC ADDRESS (PA)**

To use the Public Address system, your dealer must install an optional unit and an external speaker. This function causes all audio input via the microphone to be amplified and output through the external speaker.

To use the PA system:

- 1** Press the key programmed as **Public Address** or access the Public Address function through the Menu {page 12}
  - PA appears on the display when the PA system is active.
- 2** Press and hold the microphone **PTT** switch, then speak into the microphone.
  - Use the **Volume Up** and **Volume Down** keys to adjust the audio output from the external speaker.
- 3** Press the **Public Address** key again or change the zone or CH/GID to return to normal operation.

# BACKGROUND OPERATIONS

Your dealer can activate a variety of transceiver functions to perform without any additional operation on your part.

## TIME-OUT TIMER (TOT)

The Time-out Timer is used to prevent any caller from using a channel for an extended period of time.

If you continuously transmit for a period of time that exceeds the programmed time, the transceiver will stop transmitting and an alert tone will sound. To stop the tone, release the microphone **PTT** switch.

If programmed by your dealer, a pre-alert tone will sound before the timer expires. Also, if programmed by your dealer, you may have to wait for a short duration before you can continue to transmit. If you press the microphone **PTT** switch before the timer has been reset, an alert tone will sound and the transceiver will not enter transmit mode.

## SIGNAL STRENGTH INDICATOR

The signal strength indicator displays the strength of received calls.



Strong signal



Sufficient signal



Weak signal



Very weak signal

No icon appears when no signal is available



Flashes when out of range (NXDN Trunking only)

## COMPANDER

The compander can be programmed only for specific FM channels. If it has been programmed by your dealer, transmitted signals are compressed before being sent and received signals are expanded when they arrive.

- Your dealer must set the compander for both the transmit side and the receive side in order for the compander to operate.

This background feature allows higher clarity of signals, avoiding excessive noise. This feature is not used on digital channels, as they are not susceptible to noise and interference.

## BUSY CHANNEL LOCKOUT (BCL)

On Conventional channels, if BCL is set up by your dealer, you will be unable to transmit on the channel if it is already in use. Under these circumstances, use a different channel or wait until the channel becomes free.

However, if BCL Override has also been programmed, you can transmit over the current signal:

- 1 Press and hold the microphone **PTT** switch.
  - If the channel is already in use, a warning tone will sound.
- 2 Release the **PTT** switch, then press and hold the microphone **PTT** switch again within half a second.
- 3 Speak into the transceiver as you would during a normal call.

## CONTROL CHANNEL HUNT

On digital Trunking channels, the transceiver must search for a control channel. While searching for a control channel, no signals can be received. The search begins automatically when you change to a digital Trunking channel.

- While hunting for a control channel, the antenna icon will flash. When an available system has been found, the antenna icon remains on the display without flashing.

## PTT ID

PTT ID is the transceiver unique ID code which is sent each time the microphone **PTT** switch is pressed.

---

**Note:** PTT ID can be made only in analog operation.

---

If Beginning of Transmit is set, the ID signal is transmitted when you press the microphone **PTT** switch.

If End of Transmit is set, the ID signal is transmitted when you release the microphone **PTT** switch.

If both are set, the ID signal is transmitted when you press and release the microphone **PTT** switch.

# VGS-1 OPTIONAL VOICE GUIDE & STORAGE UNIT

When using the optional VGS-1 voice guide & storage unit, you gain access to the voice recorder and voice announcement functions. Ask your dealer for details.

## VOICE RECORDER

The voice recorder provides you with an auto recorder to record your conversations and a voice memo function to create voice memos.

### ■ Auto Recording

If activated, the auto recording function will continuously record all transmitted and received signals. The recording storage area retains 30 seconds of recording, so all transmitted and received signals are simultaneously recorded and erased, leaving only the last 30 seconds of recording in memory.

- The  icon appears on the display when this function is activated.

### ■ Voice Memos

To record a voice memo, for later playback:

- 1 Press the key programmed as **Voice Memo**, press and hold the key programmed as **Playback** for 1 second, or access the Voice Memo function through the Menu {page 12}.
  - The duration of recording memory will appear on the display and begin counting down.
- 2 Speak into the microphone to record your voice memo.
- 3 Press the  key to end the recording at any time and store it into the transceiver memory.
  - If the memory becomes full, recording will stop automatically and store the voice memo to memory.





## ■ Auto Reply Message

You can set the transceiver to automatically respond to Individual Calls (while using FleetSync/NXDN):

- 1 Press the key programmed as **Auto Reply Message** to enter Auto Reply Message mode.
  - The  icon appears on the display.
- 2 When you receive an Individual Call, Auto Reply will begin after waiting for 3 seconds, the transceiver will send an automatic response to the caller, and “GREETING” appears on the display
  - If you are available to receive the call, press any key to cancel the auto response.
  - If there is a channel available on your transceiver for recording, “I am not available. Leave your Message.” will be sent to the caller. The caller can then leave a recorded message on your transceiver which you can later recall and listen to. When a message is stored on your transceiver, “Msg Rcvd” appears on the display.
  - If there is no channel available on your transceiver for recording, “I am not available” will be sent to the caller and “MEMORY FULL” appears on the display.

## ■ Playback

To play back a recorded conversation, memo, or message:

- 1 Press the key programmed as **Playback** or access the Playback function through the Menu {page 12}.
  - If the last action on your transceiver was to auto record your conversation, “STORE?” will appear on the display, otherwise a recording channel with the time of the recording will appear.
- 2 Press the / keys to select the channel you want to play back.
  - “AR” represents auto recorded conversations.
  - “RM” represents auto reply messages.
  - “VM” represents voice memos.
- 3 The transceiver will announce the time and channel, then the recording will automatically play back.
  - When the entire recording has been played, “END OF MESSAGE” is displayed. You can also end the recording at any time by pressing the  key.
  - To delete the selected recording, press the  key. To clear all the recorded data, press and hold the  key.

## VOICE GUIDE

If set up by your dealer, when changing the zone and/or channel, an audio voice will announce the new zone and channel number/group ID. Additionally, when changing a function setting, an audio voice will announce the new setting. (Voice announcements vary by dealer setting.)

**KENWOOD**