

KENWOOD

TK-780/TK-880

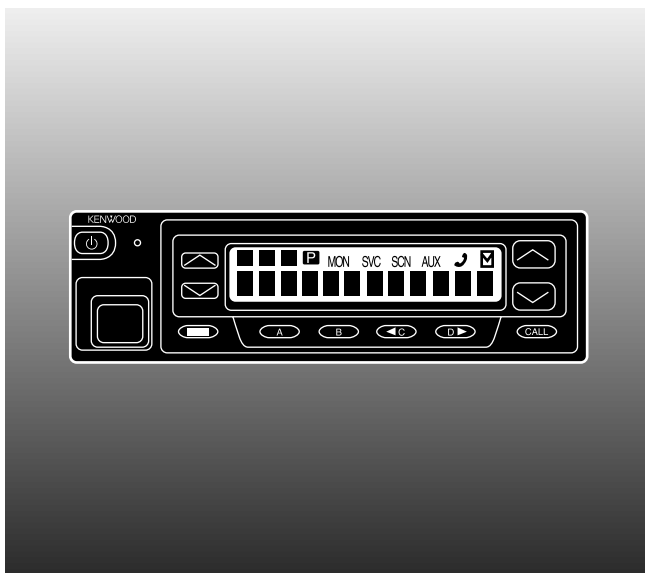

VHF FM TRANSCEIVER/ UHF FM TRANSCEIVER

INSTRUCTION MANUAL

ÉMETTEUR-RÉCEPTEUR FM VHF/ ÉMETTEUR-RÉCEPTEUR FM UHF

MODE D'EMPLOI

TRANSCÉPTOR FM VHF/ TRANSCÉPTOR FM UHF

MANUAL DE INSTRUCCIONES

VHF-FM-TRANSCEIVER/ UHF-FM-TRANSCEIVER

BEDIENUNGSANLEITUNG

RICETRASMETTITORE FM VHF/ RICETRASMETTITORE FM UHF

MANUALE DI ISTRUZIONI

VHF FM ZENDONTVANGER/ UHF FM ZENDONTVANGER

GEBRUIKSAANWIJZING

KENWOOD CORPORATION

© B62-1438-10 (E)
09 08 07 06 05 04 03 02 01

VHF FM TRANSCEIVER/
UHF FM TRANSCEIVER

TK-780/ TK-880

INSTRUCTION MANUAL

KENWOOD CORPORATION

ENGLISH

THANK YOU!

We are grateful you chose **KENWOOD** for your personal mobile applications. We believe this easy-to-use transceiver will provide dependable communications to keep personnel operating at peak efficiency.

KENWOOD transceivers incorporate the latest in advanced technology. As a result, we feel strongly that you will be pleased with the quality and features of this product.

MODELS COVERED BY THIS MANUAL

- **TK-780:** VHF FM Transceiver
- **TK-880:** UHF FM Transceiver

PRECAUTIONS

Please observe the following precautions to prevent fire, personal injury, and transceiver damage.

- Do not attempt to configure the transceiver while driving; it is too dangerous.
- Do not modify the transceiver for any reason.
- Do not expose the transceiver to long periods of direct sunlight, nor place it near heating appliances.
- Do not place the transceiver in excessively dusty, humid, or wet areas, nor on unstable surfaces.
- If an abnormal odour or smoke is detected coming from the transceiver, turn OFF the power immediately. Contact your **KENWOOD** dealer.

NOTICES TO THE USER

- | |
|---|
| <ul style="list-style-type: none">◆ <i>GOVERNMENT LAW PROHIBITS THE OPERATION OF UNLICENSED RADIO TRANSMITTERS WITHIN THE TERRITORIES UNDER GOVERNMENT CONTROL.</i>◆ <i>ILLEGAL OPERATION IS PUNISHABLE BY FINE AND/OR IMPRISONMENT.</i>◆ <i>REFER SERVICE TO QUALIFIED TECHNICIANS ONLY.</i> |
|---|

SAFETY: It is important that the operator is aware of, and understands, hazards common to the operation of any transceiver.

WARNING!

- | |
|--|
| <ul style="list-style-type: none">◆ EXPLOSIVE ATMOSPHERES (GASES, DUST, FUMES, etc.)
<i>Turn OFF your transceiver while taking on fuel or while parked in a gasoline service station. Do not carry spare fuel containers in the trunk of your vehicle if your transceiver is mounted in the trunk area.</i>◆ INJURY FROM RADIO FREQUENCY TRANSMISSIONS
<i>Do not operate your transceiver when somebody is either touching the antenna or standing within two to three feet of it, to avoid the possibility of radio frequency burns or related physical injury.</i>◆ DYNAMITE BLASTING CAPS
<i>Operating the transceiver within 500 feet of dynamite blasting caps may cause them to explode. Turn OFF your transceiver when in an area where blasting is in progress, or where "TURN OFF TWO-WAY RADIO" signs have been posted. If you are transporting blasting caps in your vehicle, make sure they are carried in a closed metal box with a padded interior. Do not transmit while the caps are being placed into or removed from the container.</i> |
|--|

CONTENTS

UNPACKING AND CHECKING EQUIPMENT	1
SUPPLIED ACCESSORIES	1
PREPARATION	2
TOOLS REQUIRED	2
POWER CABLE CONNECTION	2
INSTALLING THE TRANSCEIVER	3
ORIENTATION	4
FRONT PANEL	4
DISPLAY	5
REAR PANEL	5
PROGRAMMABLE AUXILIARY FUNCTIONS	6
BASIC OPERATIONS	8
OPERATION OVERVIEW	8
SWITCHING POWER ON/ OFF	8
ADJUSTING THE VOLUME	8
SELECTING A GROUP/ CHANNEL	8
MAKING A CALL	8
RECEIVING A CALL	8
TIME-OUT TIMER (TOT)	9
HORN ALERT	9
ADVANCED OPERATIONS	10
SCAN	10
Priority Scan	10
5-TONE SIGNALLING	10
DMS: ALPHANUMERIC 2-WAY PAGING FUNCTION	11
KEY FUNCTIONS	11
SELCALL (SELECTIVE CALLING)	12
Transmitting	12
Receiving	12
Identification Codes	12
STATUS MESSAGE	13
Transmitting	13
Receiving	13
Reviewing Messages in the Queue Memory	14
Automatic Status Response	14
SHORT MESSAGES FEATURE	14
GPS REPORT	14
DTMF (DUAL TONE MULTI FREQUENCY) CALLS	15
MAKING A DTMF CALL	15
DTMF SIGNALLING	15
STUN	15
AUDIBLE USER FEEDBACK TONES	16

UNPACKING AND CHECKING EQUIPMENT

Note: The following unpacking instructions are for use by your **KENWOOD** dealer, an authorized **KENWOOD** service facility, or the factory.

Carefully unpack the transceiver. We recommend that you identify the items listed in the following table before discarding the packing material. If any items are missing or have been damaged during shipment, file a claim with the carrier immediately.

SUPPLIED ACCESSORIES

Item	Part Number	Quantity
DC power cable	E30-3438-XX	1
Mounting bracket	J29-0627-XX	1
Speaker jack cap	B09-0235-XX	1
Screw set: <ul style="list-style-type: none">• Self-tapping screw (4 pieces)• Hex-headed screw with washer (4 pieces)• Spring washer (4 pieces)• Flat washer (4 pieces)	N99-0395-XX	1
Instruction manual	B62-1438-XX	1

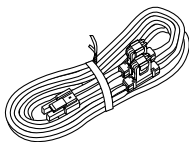

DC power cable

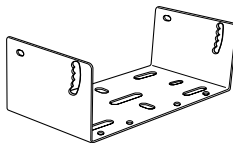

Mounting bracket



Speaker jack cap



Screw set

PREPARATION



WARNING

VARIOUS ELECTRONIC EQUIPMENT IN YOUR VEHICLE MAY MALFUNCTION IF THEY ARE NOT PROPERLY PROTECTED FROM THE RADIO FREQUENCY ENERGY WHICH IS PRESENT WHILE TRANSMITTING. ELECTRONIC FUEL INJECTION, ANTI-SKID BRAKING, AND CRUISE CONTROL SYSTEMS ARE TYPICAL EXAMPLES OF EQUIPMENT THAT MAY MALFUNCTION. IF YOUR VEHICLE CONTAINS SUCH EQUIPMENT, CONSULT THE DEALER FOR THE MAKE OF VEHICLE AND ENLIST HIS AID IN DETERMINING IF THEY WILL PERFORM NORMALLY WHILE TRANSMITTING.

Note: *The following preparation instructions are for use by your **KENWOOD** dealer, an authorized **KENWOOD** service facility, or the factory.*

TOOLS REQUIRED

Note: *Before installing the transceiver, always check how far the mounting screws will extend below the mounting surface. When drilling mounting holes, be careful not to damage vehicle wiring or parts.*

The following tools are required for installing the transceiver:

- A 6 mm (1/4 inch) or larger electric drill.
- A 4.2 mm (5/32 inch) drill bit for the 5 x 16 mm self-tapping screws, and a 3.2 mm (1/8 inch) drill bit for the 4 x 16 mm self-tapping screws.
- Circle cutters.

POWER CABLE CONNECTION



CAUTION

- ◆ *THE TRANSCEIVER OPERATES IN 12 V NEGATIVE GROUND SYSTEMS ONLY! CHECK THE BATTERY POLARITY AND VOLTAGE OF THE VEHICLE BEFORE INSTALLING THE TRANSCEIVER.*
- ◆ *LOCATE THE POWER INPUT CONNECTOR AS CLOSE TO THE TRANSCEIVER AS POSSIBLE.*

- 1 Check for an existing hole, conveniently located in the firewall, where the power cable can be passed through.
 - If no hole exists, use a circle cutter to drill the firewall, then install a rubber grommet.
- 2 Run the two power cable leads through the firewall and into the engine compartment, from the passenger compartment.
- 3 Connect the red lead to the positive (+) battery terminal and the black lead to the negative (-) battery terminal.
 - Locate the fuse as close to the battery as possible.
- 4 Coil and secure the surplus cable with a retaining band.
 - Be sure to leave enough slack in the cables so the transceiver can be removed for servicing while keeping the power applied.

INSTALLING THE TRANSCEIVER



WARNING

FOR PASSENGER SAFETY, INSTALL THE TRANSCEIVER SECURELY, USING THE SUPPLIED MOUNTING BRACKET, SO THE TRANSCEIVER WILL NOT BREAK LOOSE IN THE EVENT OF A COLLISION.

- 1 Mark the position of the holes in the dash by using the mounting bracket as a template. Drill the holes, then attach the mounting bracket using the supplied 5 x 16 mm screws.
 - Be sure to mount the transceiver in a location where the controls will be within easy reach of the user and where there is sufficient space at the rear of the transceiver for cable connections.
- 2 Connect the antenna and the supplied power cable to the transceiver.
- 3 Slide the transceiver into the mounting bracket and secure it using the supplied hex-headed screws.

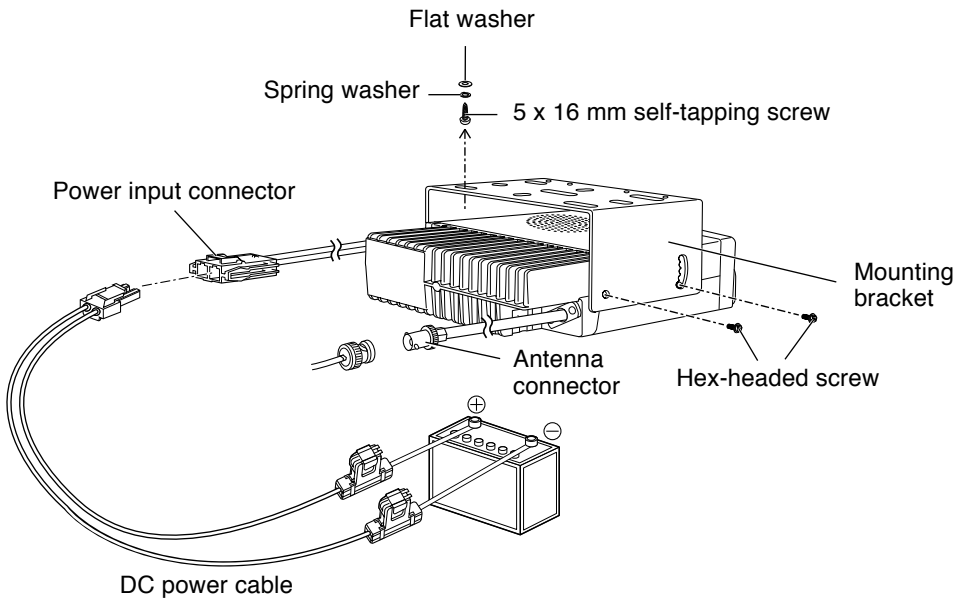

ORIENTATION

FRONT PANEL

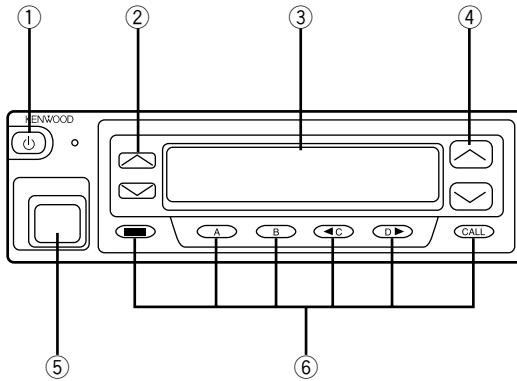

- ① **⏻ (Power) switch**
Press to switch the transceiver ON (or OFF).
- ② **^ / v keys**
Press these keys to activate their programmable auxiliary functions {page 6}.
- ③ **Display**
See page 5 for more information.
- ④ **^ / v keys**
Press these keys to activate their programmable auxiliary functions {page 6}.
- ⑤ **Microphone jack**
Insert the microphone plug into this connector.
- ⑥ **■, A, B, ◀C, D▶, and CALL keys**
Press these keys to activate their programmable auxiliary functions {page 6}.

DISPLAY

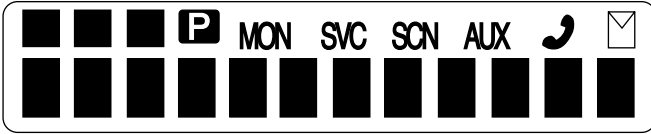

Indicator	Description
■ ■ ■	Displays the group and channel numbers as well as various dealer programmable functions.
P	Appears when the selected channel is a priority channel.
MON	Appears when you press key programmed as Monitor .
SVC	This icon is not used on this transceiver.
SCN	Appears while you are in Scan mode.
AUX	Appears when you activate the auxiliary function.
☎	This icon is not used on this transceiver.
✉	Appears when a message is stored in the queue memory. Flashes when you receive a new message.
■■■■■■■■■■	Displays the group and channel number or name (which your dealer can program with up to 10 characters) as well as received messages when using DMS. The left most display is used as an add indicator (▼) and the right most display is used for Selective Call (:*) and Scrambler (_). The add indicator shows the channels that are not locked out of the scanning sequence. Selective Call and Scrambler are dealer programmable optional functions.

REAR PANEL

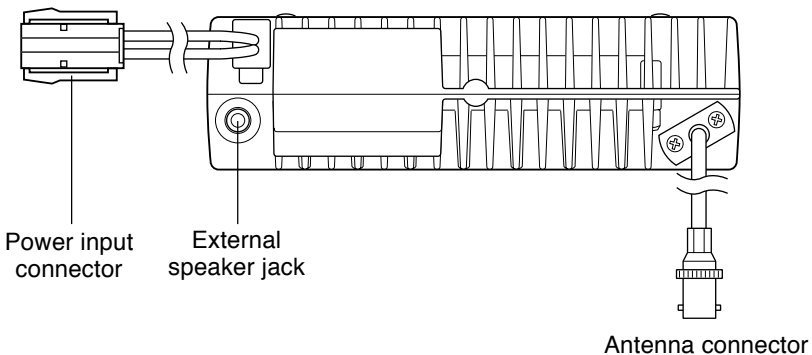

PROGRAMMABLE AUXILIARY FUNCTIONS

Keys ②, ④, and ⑥ {page 4} can be programmed with the auxiliary functions listed in the following table. The keys can only be programmed with functions, depending on whether you are using a DTMF/2-Tone/DMS model or a 5-Tone model. Please contact your dealer for further details on these functions.

Function	DTMF/2-Tone/ DMS model	5-Tone model
Auto Dial	Yes	Yes
Autodial Programming	Yes	No
AUX A	Yes	Yes
AUX B	Yes	Yes
Call 1	No	Yes
Call 2	No	Yes
Call 3	No	Yes
Call 4	No	Yes
Call 5	No	Yes
Call 6	No	Yes
Channel Down	Yes	Yes
Channel Entry	Yes	Yes
Channel Name	Yes	Yes
Channel Up	Yes	Yes
Emergency Call	Yes	Yes
Fixed Volume	Yes	Yes
Group Down	Yes	Yes
Group Up	Yes	Yes
Home Channel	Yes	Yes
Horn Alert	Yes	Yes
Key Lock	Yes	Yes
Monitor	Yes	Yes
Monitor Momentary	Yes	Yes
None	Yes	Yes
Operator Sel Tone	Yes	Yes
Public Address	Yes	Yes
Queue	Yes	Yes
Radio Password	Yes	Yes
Receive Entry	No	Yes

Function	DTMF/2-Tone/ DMS model	5-Tone model
Scan	Yes	Yes
Scan Delete/Add	Yes	Yes
Scrambler	Yes	Yes
Selcall Entry	No	Yes
Selcall List	No	Yes
Selcall + Status Entry	No	Yes
Selcall + Status List	No	Yes
Send GPS	Yes	No
Shift	Yes	Yes
Squelch Level	Yes	Yes
Squelch Momentary	Yes	Yes
Squelch Off	Yes	Yes
Status Entry	No	Yes
Status List	No	Yes
Talk Around	Yes	Yes
Transfer	No	Yes
Volume Down	Yes	Yes
Volume Up	Yes	Yes
Channel Up/ Down	Yes	Yes
Group Up/ Down	Yes	Yes

BASIC OPERATIONS

OPERATION OVERVIEW

Your dealer can program your transceiver for DTMF/2-Tone/DMS signalling or 5-Tone signalling.

This transceiver can handle up to 250 groups with 250 channels in each group. Groups, channels, and their functions are programmed by your dealer.

SWITCHING POWER ON/ OFF

Press the \odot switch to switch the transceiver ON (or OFF).

ADJUSTING THE VOLUME

Press the keys programmed as **Volume Up** and **Volume Down** to adjust the volume. **Volume Up** increases the volume; **Volume Down** decreases it.

SELECTING A GROUP/ CHANNEL

Select the desired group and channel using the keys programmed with the **Group** and **Channel** functions.

MAKING A CALL

Note: *If the selected channel is programmed with QT (Quiet Talk) or DQT (Digital Quiet Talk), remove the microphone from the microphone hanger to disable QT or DQT, then listen to the channel to make sure nobody is talking on it. If the selected channel is not programmed with QT or DQT, simply listen to the channel to make sure nobody is talking on it; in this case, you need not remove the microphone from its hanger.*

- 1 Select your desired group and channel.
 - If the channel is busy, wait until it becomes free.
- 2 Press and hold the **PTT** switch, then speak into the microphone. Release the **PTT** switch to receive.
 - For best sound quality at the receiving station, hold the microphone approximately 3 ~ 4 cm (1.5 inches) from your mouth.
- 3 When your conversation is finished, return the microphone to its hanger.

RECEIVING A CALL

- 1 Select your desired group and channel. (If the Scan function has been programmed, you can switch it ON or OFF as desired.)
- 2 When you hear the dispatcher's voice, readjust the volume as necessary.

TIME-OUT TIMER (TOT)

The purpose of the Time-out Timer is to prevent any caller from using a channel for an extended period of time.

If you continuously transmit for a period of time that exceeds the programmed time, the transceiver will stop transmitting and an alert tone will sound. To stop the tone, release the **PTT** switch.

Your dealer can program the TOT time in the range of 30 seconds to 5 minutes.

HORN ALERT

If Horn Alert has been activated by your dealer, your vehicle horn or some other type of external alert, will sound when certain calls are received. This is a useful function when you are away from your vehicle.

ADVANCED OPERATIONS

SCAN

If the Scan function is programmed, groups or channels can be scanned by pressing the key programmed as **Scan**. When the **Scan** key is pressed, the SCN indicator and “-SCAN-” or the revert group/ channel number appear on the display. Scanning starts.

Scan can be used as either Single Scan or Multi Scan. Single Scan monitors only the channels of a single group. Multi Scan monitors all channels of every group.

When a call is received, scanning stops and the group and channel digits appear. Press the **PTT** switch and speak into the microphone to respond to the call. The transceiver will continue scanning after an adjustable time delay if the **PTT** switch is released and no further signal is received.

When the displayed group is not locked out of the scanning sequence, the add indicator (▼) will appear on the display.

■ Priority Scan

The priority channel must be programmed in order for Priority Scan to function.

The transceiver will automatically change to the priority channel when a signal is received on it, even if a signal is being received on a normal channel.

The **P** indicator appears when the displayed channel is the priority channel.

5-TONE SIGNALLING

5-Tone Signalling is either activated or deactivated by your dealer.

5-Tone Signalling only opens the squelch when the transceiver receives five tones corresponding to those set up in your transceiver. When the squelch opens, you will be able to hear the caller without any further action.

After a correct 5-Tone signal is received and the squelch opens, pressing the key programmed as **Monitor** will cancel the connection.

If your dealer programmed Transpond for 5-Tone Signalling, your transceiver will automatically send an acknowledgment signal to stations that called you with the correct signal.

If your dealer programmed Tone Alert for 5-Tone Signalling, your transceiver will emit a beep when the correct signal is received.

Note: *This transceiver is also capable of decoding 2-Tone signals.*

DMS: ALPHANUMERIC 2-WAY PAGING FUNCTION

DMS (Digital Message System) is an Alphanumeric 2-way Paging Function, and is a protocol owned by **KENWOOD** Corporation. DMS enables a variety of paging functions on your transceiver, some of which depend on dealer programming.

KEY FUNCTIONS

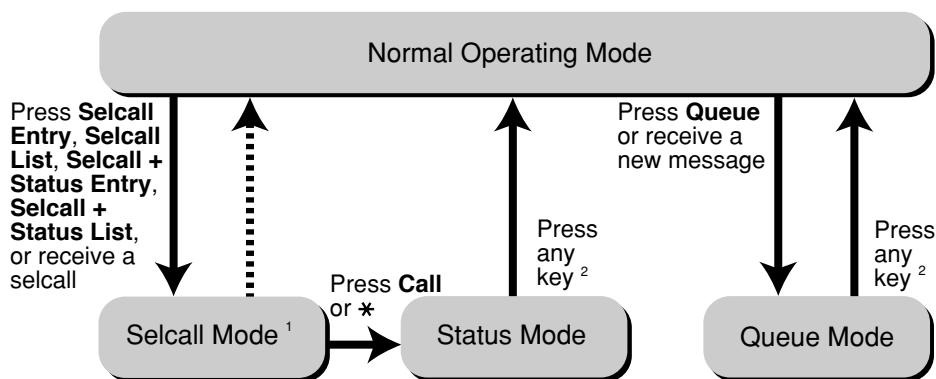

- Press **Selcall Entry**, **Selcall List**, **Selcall + Status Entry**, **Selcall + Status List**, or **Queue** to change the transceiver mode as shown in the diagram above.
- Press the **PTT** switch to initiate a call.
- Use the DTMF keypad to enter Selcall or Status numbers.

¹ Depending on how your dealer programmed the transceiver, Selcall Mode may be skipped or the transceiver may exit Selcall Mode automatically (as shown by the dash arrow). When you enter Selcall Mode after receiving a selcall, the transceiver does not enter Status Mode.

² Depending on how your dealer programmed the transceiver, the transceiver may exit these modes automatically, rather than by pressing a key.

SELCALL (SELECTIVE CALLING)

A Selcall is a voice call to a particular station or to a group of stations.

■ Transmitting

- 1 Select your desired group and channel.
- 2 Press the key programmed as **Selcall Entry** or **Selcall List** to enter Selcall Mode.
- 3 a) If you pressed **Selcall Entry** and Manual Dial is enabled, enter the ID of the station you want to call by using the microphone keypad. (Press # to erase an incorrect digit.)
b) If you pressed **Selcall List**, use the **^ / v** keys (right side keys only) to select your desired ID.
- 4 Press the **PTT** switch and begin your conversation.

■ Receiving

An alert tone will sound, the transceiver will automatically enter Selcall Mode, and the calling station's ID will appear when a Selcall is received.

To respond to the call, press the **PTT** switch and speak into the microphone.

■ Identification Codes

An ID code is a combination of a 3-digit Fleet number and a 4-digit ID number. Each transceiver must have its own Fleet and ID number.

- Enter a Fleet number (100 ~ 349) to make a fleet call.
- Enter an ID number (1000 ~ 4999) to make an individual call in your fleet.
- Enter a Group ID (which is programmed in the FPU) to make a group call.
- Enter a Fleet number followed by an ID number to make an individual call in your desired fleet (Inter-fleet call).
- Select "ALL" Fleet and "ALL" ID to make a call to all units (Broadcast call).
- Select "ALL" Fleet and enter an ID number to make a call to the selected ID in all fleets (Supervisor call).

Note:

- ◆ *Broadcast and Supervisor calls are programmed functions that cannot be made with a keypad.*
- ◆ *The ID range may be limited by programming.*





STATUS MESSAGE

You can send and receive 2-digit Status messages (10 ~ 79) which may be decided in your talk group. Messages can contain up to 16 alphanumeric characters.

A maximum of 15 received messages can be stored in the queue memory of your transceiver. These saved messages can be reviewed after reception. If the queue memory is full, the oldest message will be erased when a new message is received. The mail icon () lights when a message is stored in the queue memory.

Note: All stored messages will be cleared when the transceiver power is turned OFF.

■ Transmitting

- 1 Select your desired group and channel.
- 2 Press the key programmed as **Selcall + Status Entry** or **Selcall + Status List** to enter Selcall Mode.
- 3 a) If you pressed **Selcall + Status Entry** and Manual Dial is enabled, enter the ID of the station you want to call by using the microphone keypad. (Press # to erase an incorrect digit.)
b) If you pressed **Selcall + Status List**, use the  /  keys (right side keys only) to select your desired ID.
- 4 Press * or the key programmed as **Call (1 ~ 6)** to enter Status Mode.
- 5 a) If you pressed **Selcall + Status Entry** and Manual Dial is enabled, enter the status you want to transmit by using the microphone keypad. (Press # to erase an incorrect digit.)
b) If you pressed **Selcall + Status List**, use the  /  keys (right side keys only) to select your desired status.
- 6 Press the **PTT** switch to initiate the Status call.
 - “COMPLETE” is displayed when the call has been successfully transmitted.

■ Receiving

The mail icon () will flash.

- The Queue Mode status appears.

Press any key or wait until the pre-programmed timer expires to return to Normal Operation Mode.

■ Reviewing Messages in the Queue Memory

- 1 Press the key programmed as **Queue** to enter Queue Mode.
 - The last received message is displayed with the message number.
- 2 Use the **^** / **v** keys (right side keys only) to select the message you want to view, if more than one message is stored in the queue memory.
- 3 Press the **D▶** or **6** key to cycle through the message, the caller's ID, and the channel which received the message. Press the **◀C** or **4** key to toggle between the numeric display and the message display.
- 4 To erase the message, press and hold the **D▶** key for approximately 1 second, or press the microphone **#** key.

■ Automatic Status Response

If you pre-select a status number and then leave the transceiver in Status Mode, the transceiver will automatically respond with that status number when a request from the base station is received.

SHORT MESSAGES FEATURE

Received short messages (up to a maximum of 48 characters) are displayed in the same way as Status messages {page 13}.

GPS REPORT

If a GPS unit (NMEA-0183 format) is installed on the transceiver and the Send GPS function is programmed onto a key by your dealer, you can press the programmed key to send your location data.

DTMF (DUAL TONE MULTI FREQUENCY) CALLS

MAKING A DTMF CALL

Note: To make a DTMF call, you must have an optional microphone with a DTMF keypad. Ask your dealer for more information.

There are two methods of making DTMF calls:

Manual dialing:

- 1 Press and hold the **PTT** switch.
- 2 Enter the desired digits using the microphone keypad.
 - The corresponding DTMF tones sound each time you press a key.
 - If you release the **PTT** switch, transmit mode will end, even if the complete number has not been sent.

Store and sending:

- 1 Enter the desired digits using the microphone keypad.
 - The digits appear on the display as you enter them.
- 2 After entering the complete number, press the *** key**.
 - The DTMF code is transmitted after pressing the *** key**.

Note:

- ◆ You can only store up to 16 digits before sending. Entering more than 16 digits will cause an error tone to sound.
- ◆ If you switch the power OFF before sending the number, the number will be cleared from memory.

DTMF SIGNALLING

Your dealer can program a group with a DTMF signalling code. When you receive a call with a code that matches yours, the signalling indicator will flash and a tone will sound. Squelch opens and you will hear the call.

Squelch will close when you receive a call with a code that matches your signalling reset code.

When making a call on a group programmed with a DTMF signalling code, the signalling indicator will light and the squelch will open.

STUN

Depending on how your dealer programs your transceiver, when you receive a call containing a Stun code, either your transceiver will be disabled temporarily or permanently. When disabled temporarily, a tone will sound and “LOCK 2” will appear on the display. When disabled permanently, a tone will sound and “ERROR” will appear on the display.

Temporarily disabled transceivers are re-enabled when you receive a call with a Stun cancel code.

AUDIBLE USER FEEDBACK TONES

The transceiver emits various tones to indicate the transceiver's operating status. Contact your dealer for further information on these tones:

- Alert
- DMS Signalling Decode Alert Tone
- Group Call
- Individual Call
- Key Input Error
- Key Press [A]
- Key Press [B]
- Key Press [C]
- Power On
- Pre Alert
- Programmable Alert Tone
- Roll Over
- Transpond
- Warning