

GM350 User Guide

Contents

	Page:
Safety Information	1
General Information.....	2
Radio Controls/Indicators	2
Audio Signals.....	3
Display Icons	3
Radio On/Off	3
Channel Selection	4
4-Channel Model	4
128-Channel Model	4
Communication Procedures	4
Receiving Calls.....	4
Outgoing Calls	4
Single Tone Selective Calling	5
Option Button Functions	5
Computer Software Copyrights	6

Safety Information

Every radio, when transmitting, radiates energy into the atmosphere which may, under certain conditions, cause the generation of a spark. All users of vehicles fitted with radios should be aware of the following warning:

WARNING: Do not operate radio near inflammable liquids or in the vicinity of explosive devices



During normal use, the radio will subject you to radio energy substantially below the level where any kind of harm is reported.

To ensure personal safety, please observe the following simple rules:

- DO NOT** transmit when the antenna is very close to, or touching, exposed parts of the body, especially the face and eyes.
- DO NOT** hold the transmit (PTT) key in when not actually desiring to transmit.
- DO NOT** allow children to play with any radio equipment containing a transmitter.
- DO NOT** operate radio whilst driving. It should also be noted that the use of a hand-held microphone while driving could constitute an offence under Road Traffic Regulations.

General Information

Congratulations on choosing the GM350, an excellent mobile radio. Motorola's stringent quality procedures guarantee the high standard of Motorola products. Your radio has left our factory only after extensive tests.

This user guide describes the way a standard radio works. Since standard operation may be changed by programming, the way your radio operates may differ slightly from what is described here.

If in doubt contact the person in charge of your radio system or the Motorola dealer who supplied the equipment.

WARNING: When installing or removing the mobile radio from the vehicle, the radio must be switched off.











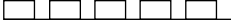
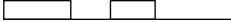

Radio Controls/Indicators

The numbers refer to the illustrations on the inside front cover.





1. Radio ON/OFF.
2. Microphone connector.
3. Volume Up/Down Control.
4. Three LED Indicators:
 - Red, continuous: Radio transmits.
 - Red, flashing: Channel busy.
 - Yellow, continuous: Monitor mode.
 - Yellow, flashing: Radio Selectively Called.
 - Green, continuous: Function button enabled (4-channel only).
 - Green, flashing: Scanning on.
 - Red, Green: Error indication. Switch radio off then on again.
 - Red, Yellow, Green:)If error indication (alternating) persists, return radio to dealer.
5. Squelch Button.
6. Programmable Option Button.
7. Channel Selection Buttons.
8. Channel Selected LEDs.
9. Programmable Option Buttons (1, 2, A and B).
10. LCD Display. Three characters + Function Icons.
11. Microphone PTT (Push To Talk).

Audio Signals

High pitched tone <input type="checkbox"/>	Medium pitched tone <input checked="" type="checkbox"/>
	Power Up - Radio self-test OK
	Power Up - Radio self-test Fail
	Side Button Error
	Force Monitor
	Keypad Acknowledge
	Call Alert
	Call Reminder
	TOT Pre Alert
	Monitor Alert
	Scan Start
	Priority Channel
	Volume Select
	H/W error - Button press not accepted, tone continues until valid operation

Display Icons (128-channel Only)

The icons which appear on the display are:

	Scan Enabled
	Monitor Enabled
	Repeater Talkaround Enabled
	External Alarm Enabled
	Coded/Clear - Scrambled speech on when icon lit*
<input type="checkbox"/>	Channel selection controlled by external source *

* Requires additional hardware option module.

Radio On/Off

To switch the radio on, press and release the ON/OFF switch. The radio performs a self-test and a high-pitched start-up tone will be heard.

If the error tone sounds, please contact the person in charge of your radio system or your local Motorola dealer.

To switch the radio off, press and hold the ON/OFF switch for 2 seconds, then release.

Channel Selection

4-Channel Model

To select a channel, press one of the four channel select buttons (7) for the desired channel. If the channel is available, the green, channel-selected LED (8) will light. If it is not, the error tone will sound.

128-Channel Model

To select a channel, use the up/down scroll buttons (7) to display the desired channel number. The channel may be used as soon as it is displayed.

Communication Procedures

Receiving Calls

When a call is received, the speaker will unmute (open) and the red LED indicator (4) will flash (Channel Busy). Unless you have some form of selective signalling on a channel, you will hear all calls on the channel.

Private Line (CTCSS) Signalling

If you use this form of signalling on your receive channels, your speaker will unmute only when it receives a call accompanied by this form of signalling. This greatly reduces interference heard on a channel, reducing operator fatigue.

This form of reception can be disabled using the monitor button (5).

Outgoing Calls

When you have selected a channel, you are ready to transmit. You should only make a call when the channel is free (red indicator (4) does not flash). If in doubt, press the monitor button (5) to listen to the channel.

Take the microphone out of its holder. Press the transmit (PTT) key (11) on the side of the microphone while talking, release it while listening. Speak in a normal tone of voice, keeping a distance of 5-10 cm from the microphone. When transmitting the red indicator (4) will light continuously. Your radio may be configured for 'Transmit Inhibit' under certain conditions (e.g. when the channel is in use by other users) in which case, the error tone will sound when you press the PTT key to indicate that transmission is inhibited.

If your radio is equipped with a transmit time out timer (TOT), a warning tone will sound a few seconds before the transmission is cut off. The radio may be programmed to inhibit retransmission within a preset time.

Hang up the microphone in its holder when your conversation has ended.

Single Tone Selective Calling

Single tone encode facilities are provided to enable selective calling, or Repeater Access. Both models may be enabled to initiate single tone selective calls; however, only the 128-channel model only may be enabled to receive single tone selective calls.

Single Tone Encode - 4-channel and 128-channel models

Subject to radio configuration, single tone selective calling may be initiated automatically from the PTT (11) or from a suitably programmed option button (6, 9).

Single Tone Decode - 128-channel model only

Subject to radio configuration, single tone selective calling may be required to receive a message on any pre-selected channel(s). When a selective call is received, you will hear the Call Alert sounded and the yellow LED (4) will flash.

Please contact the person in charge of your radio system or your local Motorola representative for further information.

Option Button Functions

The following functions may be applicable to your radio, activated by one of the function/option buttons.

- Single Tone Encode - Single tone encode may be initiated manually by pressing suitably programmed option buttons.
- Repeater Talkaround - This feature enables the transmit frequency on a channel to be switched to the same as the channel's receive frequency. This will allow a radio to communicate directly with another without the need to use a repeater.
- Monitor - One option button (usually 5) may be programmed as Monitor. This feature allows the user to switch between different receiver settings programmed as Receive, Monitor 1 and Monitor 2.
- Scan (128-channel model only) - The scan feature will cause the radio to search through predefined lists of channels looking for a condition that will cause the radio to unmute. While searching for unmute conditions, the radio is in 'active scan' (green LED flashing and Scan icon on); having found the required conditions, the radio will 'land' on the channel (green LED off, Scan icon stays on).

- Nuisance Channel Delete - When in scan, if the radio repeatedly 'lands' (stops) on a channel that is currently of no interest, press this option button when listening to the 'nuisance channel', to temporarily remove the channel from the scan list (until the radio is turned off then on again).
- Memory Channel (128-channel model only) - Up to two option buttons may be programmed as Memory Channels. Pressing the button for longer than one second selects the current channel as that button's memory channel. To select that channel subsequently, press the option button for a period of less than one second.
- External Alarm enable/disable (128-channel model only) - Turns the external alarm signal, generated by single tone decode, on/off.
- When the radio is fitted with an optional speech scrambler module, two further features may be programmed onto the option buttons.
 - Coded/Clear speech - the scrambler module may be switched on and off to suit operational requirements.
 - Key Select - Allows selection of the key used by the scrambler module.

Computer Software Copyright

The products described in this manual may include copyrighted computer programmes stored in semiconductor memories or other media. Laws in the United States of America and other countries preserve for Motorola Europe and Motorola Inc. certain exclusive rights for copyrighted computer programmes, including the right to copy or reproduce in any form the copyrighted computer programme. Accordingly, any copyrighted computer programmes contained in the products described in this manual may not be copied or reproduced in any manner without the express written permission of the holders of the rights. Furthermore, the purchase of these products shall not be deemed to grant either directly or by implication, estoppel, or otherwise, any licence under the copyrights, patents, or patent applications of the holders of the rights, except for the normal non-exclusive royalty free licence to use that arises by operation of the law in the sale of the product.

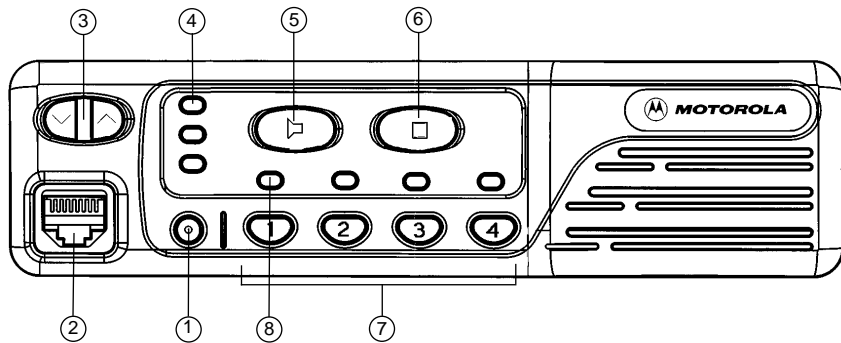

4

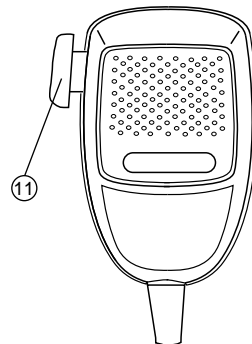

128

