



# VX-264

## OPERATING MANUAL

### PROGRAMMABLE FUNCTIONS/FEATURES

- IP55 Water Resistant
- Six Programmable Function Keys
- 2-Tone Encode/Decode
- 5-Tone Encode/Decode
- MDC-1200® Encode (ANI Encode)
- DTMF Encode
- Scan
- Group Scan
- Dual Watch
- Follow-Me Scan
- Talk Around Scan
- Voice Inversion Encryption
- VOX
- Talk Around
- Emergency
- Lone Worker
- TX Save Disable
- Lock
- ARTS™ (Auto Range Transpond System)

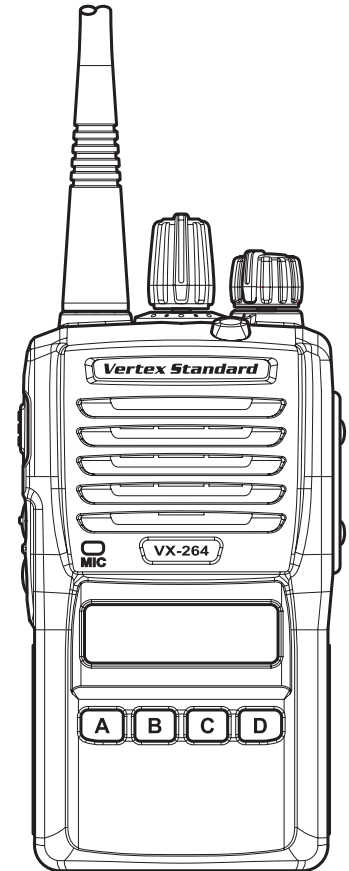

---

---

## CONTENTS

---

---

<b>Introduction</b> .....	<b>1</b>	<b>Operation</b> .....	<b>12</b>
<b>Warning! FCC RF Exposure Requirements</b> .....	<b>2</b>	Preliminary Steps .....	12
<b>Warning! IC RSS General Requirement</b> .....	<b>4</b>	Operation Quick Start.....	12
<b>Before You Begin</b> .....	<b>6</b>	Automatic Time-Out Timer.....	14
Battery Pack Installation and Removal.....	6	<b>Advanced Operation</b> .....	<b>15</b>
Battery Charging .....	6	Programmable Key Functions .....	15
Low Battery Indication.....	7	Description of Operating Functions .....	18
Belt Clip Installation and Removal .....	8	<b>Lock</b> .....	<b>27</b>
MIC/SP Cap Installation .....	8	<b>ARTS™ (Auto Range Transpond System)</b> .....	<b>27</b>
<b>Controls &amp; Connectors</b> .....	<b>10</b>	<b>Optional Accessories</b> .....	<b>28</b>
<b>LCD Icons &amp; Indicators</b> .....	<b>11</b>		

### Congratulations!

You now have at your fingertips a valuable communications tool, a Vertex Standard two-way radio! Rugged, reliable and easy to use, your Vertex Standard radio will keep you in constant touch with your colleagues for years to come, with negligible maintenance down-time. Please take a few minutes to read this manual carefully. The information presented here will allow you to derive maximum performance from your radio, in case questions arise later on.

#### Important Note

- There are no owner-serviceable parts inside the radio. All service jobs must be referred to an authorized Vertex Standard Service Representative.
- In order to maintain the specified water integrity performance, periodic maintenance is recommended.
- Should the radio sustain a severe shock (e.g. if it is dropped), the water integrity may be compromised, requiring service. Should this occur, contact your Authorized Vertex Standard Dealer.

---

---

## INTRODUCTION

---

---

The **VX-264** is full-featured Hand-Held Analog Transceiver designed for business communications in the VHF/UHF Land Mobile bands. This transceiver is designed for reliable business communications in a wide variety of applications with a wide range of operating capability provided by their leading-edge design, and allows up to 128-channel capacity within a maximum 8 groups. Each channel can be programmed with an 8-character Alpha-Numeric Tag.

Important channel frequency data is stored in the flash memory, and is easily programmable by a Vertex Standard licensed dealers using a personal computer with Vertex Standard Programming equipment: **FIF-12** USB Programming Interface, and **CT-106** Connection cable with **CE150** PC Programming Software. Or, once a single radio is programmed, cloning cable **CT-27** can be used to program additional radios directly.

This manual will describe the details of the many advanced features of the **VX-264**. After reading this manual, you may wish to consult with your Network Administrator regarding precise details of the configuration of this equipment for use in your application.

### **Important Notice for North American Users Regarding 406 MHz Guard Band**

The U.S. Coast Guard and National Oceanographic and Atmospheric Administration have requested the cooperation of the U.S. Federal Communications Commission in preserving the integrity of the protected frequency range 406.0 to 406.1 MHz, which is reserved for use by distress beacons. Do not attempt to program this apparatus, under any circumstances, for operation in the frequency range 406.0 - 406.1 MHz if the apparatus is to be used in or near North America.

Warning - Frequency band 406 - 406.1 MHz is reserved for use ONLY as a distress beacon by the US Coast Guard and NOAA. Under no circumstance should this frequency band be part of the pre programmed operating frequencies of this radio.

---

---

## WARNING! FCC RF EXPOSURE REQUIREMENTS

---

---

This Radio has been tested and complies with the Federal Communications Commission (FCC) RF exposure limits for Occupational Use/Controlled exposure environment. In addition, it complies with the following Standards and Guidelines:

- ❑ FCC 96-326, Guidelines for Evaluating the Environmental Effects of Radio-Frequency Radiation.
- ❑ FCC OET Bulletin 65 Edition 97-01 (2001) Supplement C, Evaluating Compliance with FCC Guidelines for Human Exposure to Radio Frequency Electromagnetic Fields.
- ❑ ANSI/IEEE C95.1-1992, IEEE Standard for Safety Levels with Respect to Human Exposure to Radio Frequency Electromagnetic Fields, 3 kHz to 300 GHz.
- ❑ ANSI/IEEE C95.3-1992, IEEE Recommended Practice for the Measurement of Potentially Hazardous Electromagnetic Fields - RF and Microwave.

**⚠ WARNING:**

This radio generates RF electromagnetic energy during transmit mode. This radio is designed for and classified as **Occupational Use Only**, meaning it must be used only during the course of employment by individuals aware of the hazards, and the ways to minimize such hazards. This radio is not intended for use by the General Population in an uncontrolled environment.

**⚠ CAUTION:**

To ensure that your exposure to RF electromagnetic energy is within the FCC allowable limits for occupational use, always adhere to the following guidelines:

- **This radio is NOT approved for use by the general population in an uncontrolled exposure environment. This radio is restricted to occupational use, work related operations only where the radio operator must have the knowledge to control his or her RF exposure conditions.**
- **When transmitting, hold the radio in a vertical position with its microphone 1 inch (2.5 cm) away from your mouth and keep the antenna at least 1 inch (2.5 cm) away from your head.**
- **Transmit no more than the rated duty factor of 50% of the time. To transmit (talk), push the Push-To-Talk (PTT) button. To receive calls, release the PTT button. The PTT button may reside on the radio itself or may be hosted**

---

---

## WARNING! FCC RF EXPOSURE REQUIREMENTS

---

---

on approved accessories. Transmitting 50% of the time, or less, is important because this radio generates measurable RF energy exposure only when transmitting (in terms of measuring for standards compliance).

The radio is transmitting when the red LED on the top of the radio is illuminated. You can cause the radio to transmit by pressing the P-T-T button.

- **In front of the face.** Hold the radio in a vertical position with the microphone (and other parts of the radio including the antenna) at least 1 inch (2.5 cm) away from the nose or lips. Keeping the radio at a proper distance is important to ensure compliance.
- **SAR compliance for body-worn use** was only demonstrated for the specific belt-clip (CLIP-20). Other body-worn accessories or configurations may NOT comply with the FCC RF exposure requirements and should be avoided.
- Always use Vertex Standard authorized accessories.
- The information listed above provides the user with the information needed to make him or her aware of RF exposure, and what to do to assure that this radio operates with the FCC RF exposure limits of this radio.
- **Electromagnetic Interference/Compatibility**

During transmissions, this radio generates RF energy that can possibly cause interference with other devices or systems. To avoid such interference, turn off the radio in areas where signs are posted to do so.

Do not operate the transmitter in areas that are sensitive to electromagnetic radiation such as hospitals, health care facilities, aircraft, and blasting sites.

---

---

## WARNING! IC RSS GENERAL REQUIREMENT

---

---

### ENGLISH

❑ Under Industry Canada regulations, this radio transmitter may only operate using an antenna of a type and maximum (or lesser) gain approved for the transmitter by Industry Canada. To reduce potential radio interference to other users, the antenna type and its gain should be so chosen that the equivalent isotropically radiated power (e.i.r.p.) is not more than that necessary for successful communication.

❑ This radio transmitter (identify the device by certification number, or model number if Category II) has been approved by Industry Canada to operate with the antenna types listed at the right with the maximum permissible gain and required antenna impedance for each antenna type indicated. Antenna types not included in this list, having a gain greater than the maximum gain indicated for that type, are strictly prohibited for use with this device.

VHF MODEL	UHF MODEL
ATV-8A: -2.15 dBi, 50-ohm	ATU-6A: -2.15 dBi, 50-ohm
ATV-8B: -2.15 dBi, 50-ohm	ATU-6B: -2.15 dBi, 50-ohm
ATV-8C: -2.15 dBi, 50-ohm	ATU-6C: -2.15 dBi, 50-ohm
ATV-6XL: -2.15 dBi, 50-ohm	ATU-6D: -2.15 dBi, 50-ohm
	ATU-6F: -2.15 dBi, 50-ohm

○ **When transmitting, hold the radio in a vertical position with its microphone 1 inch (2.5 cm) away from your mouth and keep the antenna at least 1 inch (2.5 cm) away from your head.**

○ **The radio must be used with a maximum operating duty cycle not exceeding 50%, in typical Push-to-Talk configurations.**

**DO NOT transmit for more than 50% of total radio use time (50% duty cycle). Transmitting more than 50% of the time can cause IC RSS General Requirement to be exceeded. To keep the Body Worn configuration with the Vertex Standard CLIP-20 belt-clip, reduce the maximum operating duty cycle still more.**

**The radio is transmitting when the red LED on the top of the radio is illuminated. You can cause the radio to transmit by pressing the P-T-T button.**

○ **SAR compliance for body-worn use was only demonstrated for the specific belt-clip (CLIP-20). Other body-worn accessories or configurations may NOT comply with the IC RSS General Requirement and should be avoided.**

---

## WARNING! IC RSS GENERAL REQUIREMENT

---

### FRENCH

- ❑ Conformément à la réglementation d'Industrie Canada, le présent émetteur radio peut fonctionner avec une antenne d'un type et d'un gain maximal (ou inférieur) approuvé pour l'émetteur par Industrie Canada. Dans le but de réduire les risques de brouillage radioélectrique à l'intention des autres utilisateurs, il faut choisir le type d'antenne et son gain de sorte que la puissance isotrope rayonnée équivalente (p.i.r.e.) ne dépasse pas l'intensité nécessaire à l'établissement d'une communication satisfaisante.
- ❑ Le présent émetteur radio (identifier le dispositif par son numéro de certification ou son numéro de modèle s'il fait partie du matériel de catégorie I) a été approuvé par Industrie Canada pour fonctionner avec les types d'antenne énumérés dans le droit et ayant un gain admissible maximal et l'impédance requise pour chaque type d'antenne. Les types d'antenne non inclus dans cette liste, ou dont le gain est supérieur au gain maximal indiqué, sont strictement interdits pour l'exploitation de l'émetteur.
- | VHF MODÈLE                 | UHF MODÈLE                |
|----------------------------|---------------------------|
| ATV-8A: -2.15 dBi, 50-ohm  | ATU-6A: -2.15 dBi, 50-ohm |
| ATV-8B: -2.15 dBi, 50-ohm  | ATU-6B: -2.15 dBi, 50-ohm |
| ATV-8C: -2.15 dBi, 50-ohm  | ATU-6C: -2.15 dBi, 50-ohm |
| ATV-6XL: -2.15 dBi, 50-ohm | ATU-6D: -2.15 dBi, 50-ohm |
|                            | ATU-6F: -2.15 dBi, 50-ohm |
- **Pour émettre, tenez votre radio verticalement en plaçant le microphone entre 2,5 cm de la bouche. L'antenne doit toujours être à plus de 2,5 cm de votre tête.**
- **Le temps total d'émission de la radio ne doit pas dépasser 50% du temps de fonctionnement dans une configuration normale avec alternat. Par conséquent, vous ne devez PAS émettre pendant plus de 50% du temps total d'utilisation de la radio. Si cette règle n'est pas respectée, vous exposez à un dépassement de l'exposition aux fréquences électromagnétiques telle que définie par la norme de sécurité. La radio émet lorsque le voyant LED rouge (situé au sommet de la radio) est allumé. Vous pouvez déclencher l'émission en appuyant sur le bouton Alternat ou avec un micro-casque VOX, si la radio permet d'utiliser cet accessoire.**
- **La conformité SAR pour utilisation sur le corps n'a été confirmée que pour l'attache ceinture de nomenclature CLIP-20. L'utilisation de tout autre accessoire pour port sur le corps PEUT être non conforme aux normes d'exposition aux radio-fréquences et doit donc être évitée.**
- **N'opérez pas votre radio en mode d'émission lorsque vous la portez fixée sur le corps à l'aide de l'accessoire suivant : CLIP-20 attache ceinture.**

---

## BEFORE YOU BEGIN

---

### Battery Pack Installation and Removal

- ❑ To install the battery pack, align the battery pack to the radio with an offset about 1/2 inch (1.5 cm) from the top edge of battery compartment, then slide the battery pack upward until it locks in place with a “*Click.*”

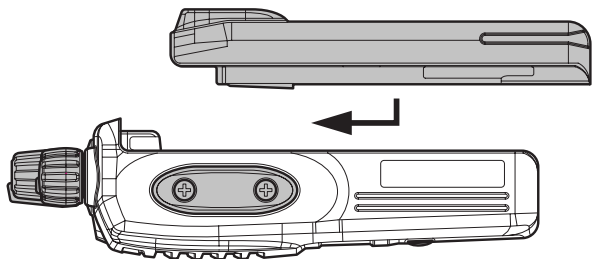

- ❑ To remove the battery, turn the radio off and remove any protective cases. Slide the Battery Pack Latch on the bottom of the radio toward the front panel while sliding the battery down about 1/2 inch (1.5 cm). Then lift the battery out from the radio.

 **Do not attempt to open any of the rechargeable Lithium-Ion packs, as they could explode if accidentally short-circuited.**

### Battery Charging

- ❑ Remove the Spacer Plate from the nest of the optional **CD-58** Desktop Charger, if the Battery Spacer is installed.
- ❑ Insert the DC plug from the optional **PA-55** AC Adapter into the DC jack on the rear panel of the optional **CD-58** Desktop Charger, and then connect the **PA-55** AC Adapter to the AC line outlet.
- ❑ Insert the battery pack into the **CD-58** Desktop Charger while aligning the slots of the battery pack with the guides in the nest of the **CD-58**; refer to the following illustration for details on proper positioning of the

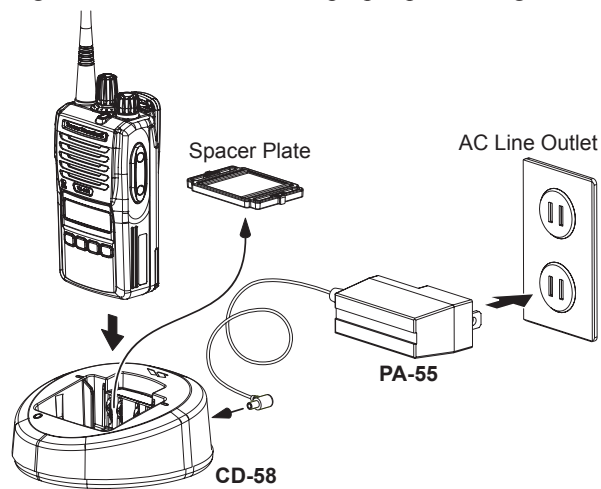



---

## BEFORE YOU BEGIN

---

battery pack. If charging with the transceiver attached, turn the transceiver off. The antenna jack should be at the left side when viewing the charger from the front.

- ❑ If the battery pack is inserted correctly, the LED indicator will glow red. A fully-discharged battery pack will charge completely in 1.5 - 3.0 hours (depending on the battery pack being charged).
- ❑ When charging is completed, the LED indicator will change to green.
- ❑ Disconnect the battery pack from the **CD-58** Desktop Charger and unplug the **PA-55** AC Adapter from the AC line outlet.



*1) Always use the Vertex Standard FNB-V133LI-UNI or FNB-V134LI-UNI Lithium-Ion Battery Pack.*

*2) Use only the Vertex Standard CD-58 Desktop Charger and the Vertex Standard PA-55 AC Adapter.*

*3) To reduce the risk of explosion, recharge the batteries outside of hazardous locations.*

*4) Perform the battery charging where the ambient temperature range +41 °F to +104 °F (+5 °C to +40 °C). Charging outside of this temperature range could cause damage to the battery pack.*

*5) Battery Pack should not be exposed to excessive heat such as sunshine, fire, or similar heat sources.*

*6) Risk of explosion exists if battery is replaced by an incorrect type. Refer to the enclosed instructions for disposal of used batteries.*

*7) For further details and cautions of the charging, refer to the Operating Manual of the CD-58 Desktop Charger.*

### Low Battery Indication

As the battery discharges during use, the voltage gradually becomes lower. When the battery voltage becomes too low, substitute a freshly charged battery and recharge the depleted pack. The LED indicator on the top of the radio will blink red when the battery voltage is low.

You may confirm the battery condition by the Battery Icon on the display. See page 11 for more information.

#### **CAUTION**

Danger of explosion if battery is replaced with an incorrect battery. Replace only with the same or equivalent type.

---

## BEFORE YOU BEGIN

---

### Belt Clip Installation and Removal

- ❑ To install the Belt Clip: align the Belt Clip to the groove of the Battery pack, then press the Belt Clip downward until it locks in place with a “Click.”
- ❑ To remove the Belt Clip: use a flat head screw driver to press the Belt Clip Tab away from the battery pack to unlock the Belt Clip, then slide the Belt Clip upward to remove it.

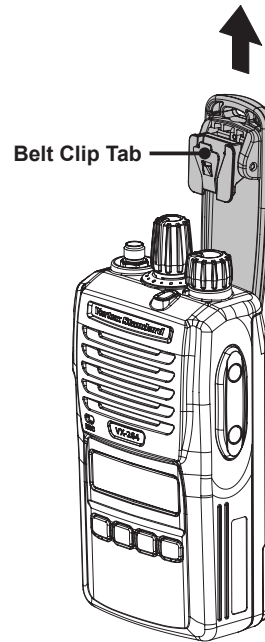
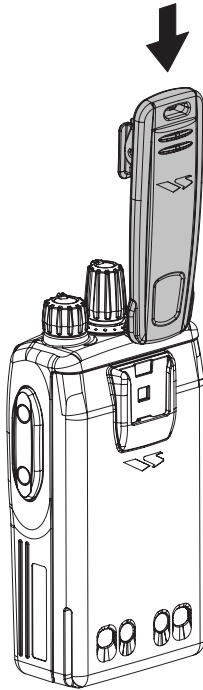

### MIC/SP CAP Installation

Install the **MIC/SP** cap with the supplied screws.

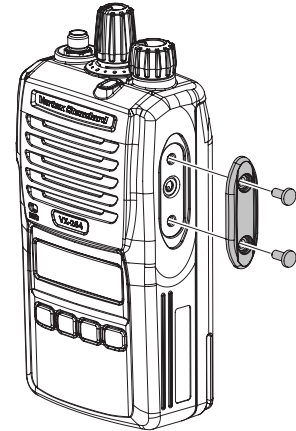

- ❑ Use only the supplied screws when install the **MIC/SP** cap.
- ❑ This radio does not keep the **Water Resistant Rating (IP55)** when the **MIC/SP** cap is not installed in the **MIC/SP** jack.

---

---

## NOTE

---

---

---

## CONTROLS & CONNECTORS

---

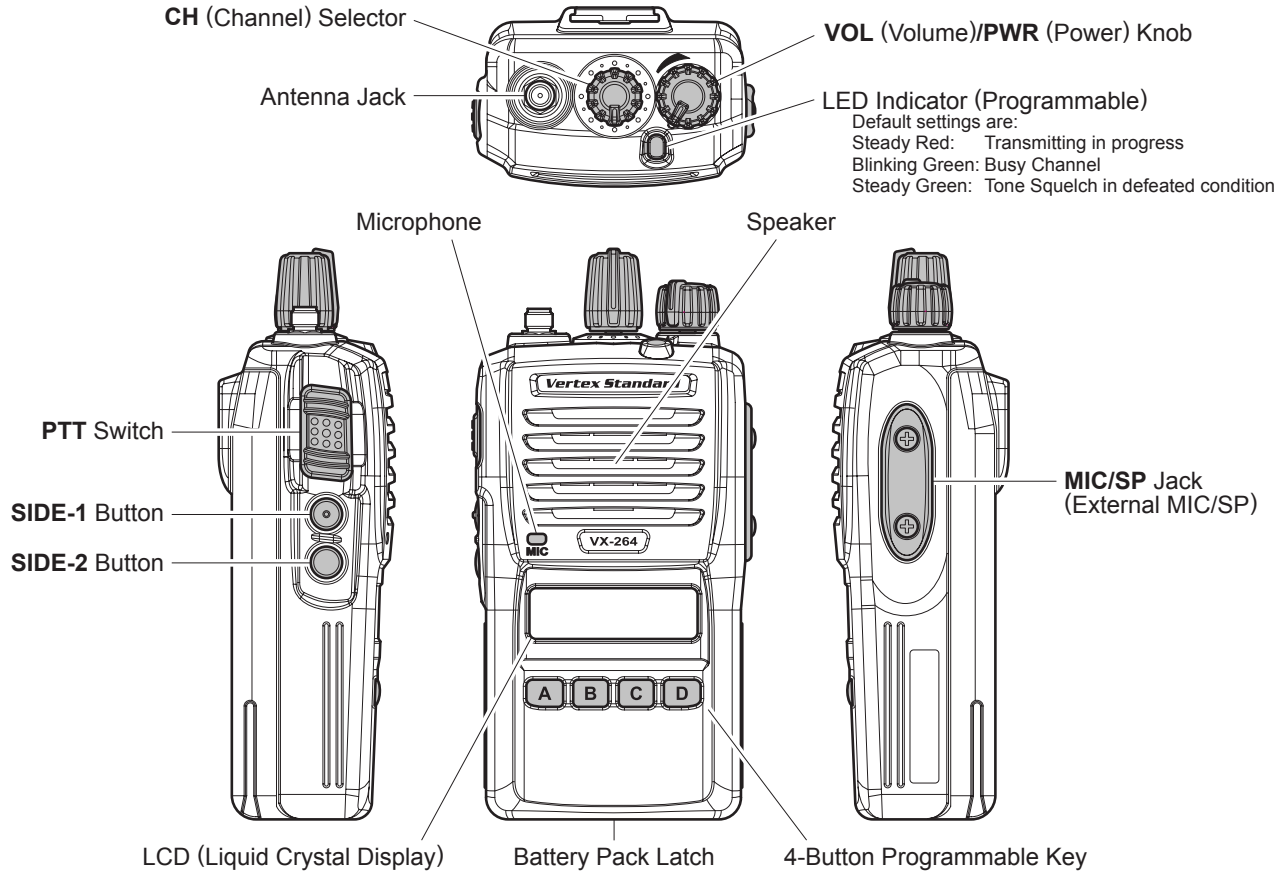

# LCD ICONS & INDICATORS

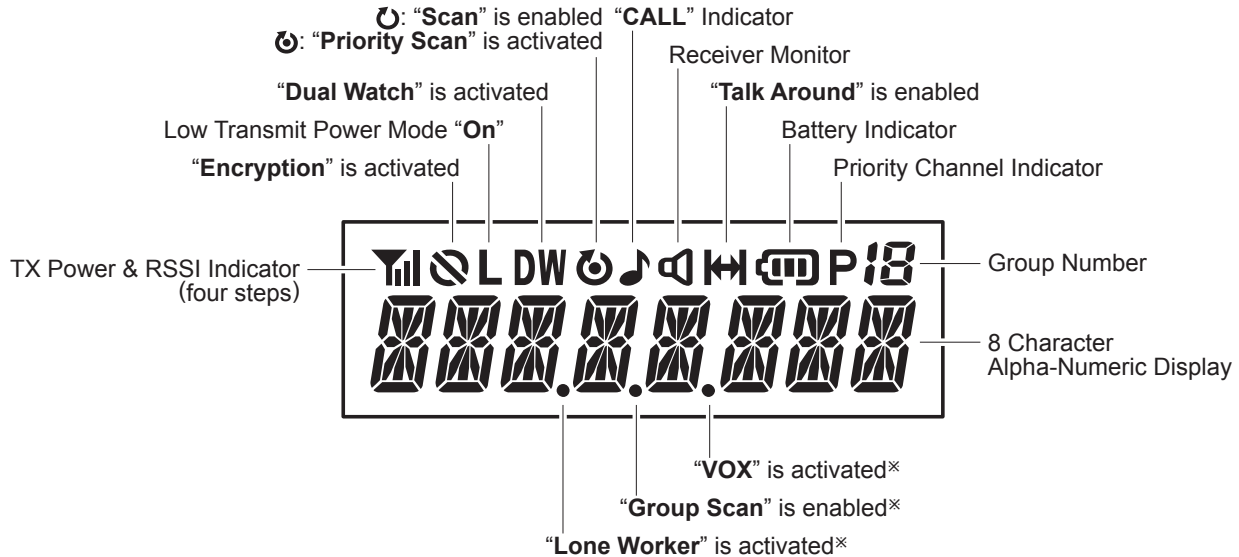

※ These small dot appears continuously until each function is turned "OFF", regardless of the operation of other features.

For example, when activates the Emergency feature while the Lone Worker feature is activating, the display indicate at the right.



"Lone Worker" is activated

BATTERY INDICATOR
: Full Battery Power
: Moderate Battery Power
: Low Battery Power
w/blink : Poor Battery Power (Charge the Battery)

## OPERATION

### Preliminary Steps

- ❑ Install a charged battery pack onto the transceiver, as described on page 8 of this manual.

- ❑ Screw the supplied antenna onto the Antenna jack.

It is not recommended to operate this transceiver without an antenna connected.

- ❑ If you have a Speaker/Microphone, we recommend that it not be connected until you are familiar with the basic operation of the **VX-264**. Refer to next page for more information about Speaker/Microphone usage.

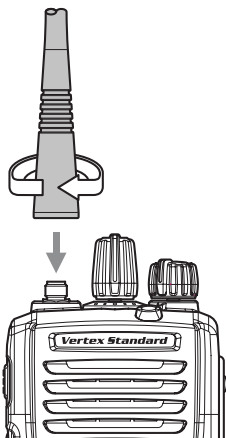

#### IMPORTANT NOTE

The water resistance rating of the transceiver (IP55) is assured only when the following conditions are met:

- ❑ Battery pack is attached to the transceiver;
- ❑ Antenna is connected to the antenna jack;
- ❑ **MIC/SP** cap is installed in the **MIC/SP** jack.
- ❑ Use of a speaker microphone in the **MIC/SP** jack negates the IP55 rating.

### Operation Quick Start

- ❑ Turn the top panel's **VOL/PWR** knob clockwise to turn the radio on.

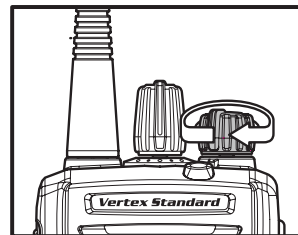

- ❑ Turn the top panel's **CH** Selector knob to choose the desired operating channel. A channel name will appear on the LCD.

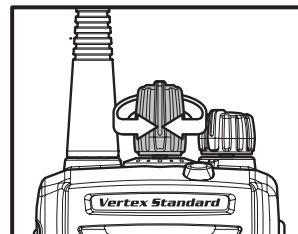

- ❑ If you want to select the operating channel from a different Channel Group, press (or press and hold) the Programmable key assigned to the “**GROUP UP/DOWN**” function to change desired Channel Group before selecting the operating channel.

*Note:* Some models are programmed so that the operating channels are selected by the Programmable key and the Channel Group is selected by the **CH** Selector knob. For further details, contact your Vertex Standard dealer.

## OPERATION

- ❑ Rotate the **VOL/PWR** knob to set the volume level. If no signal is present, press (or press and hold) the Programmable key (assigned to the “**SQL OFF**” function:



Normally **SIDE-1** button); background noise will now be heard, and you may use this to set the **VOL/PWR** knob for the desired audio level. Press (or press and hold) the Programmable key again to quiet the noise and resume normal (quiet) monitoring.

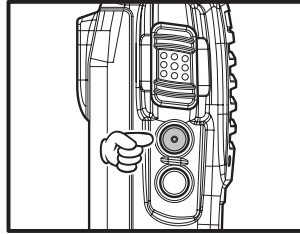

- ❑ To transmit, monitor the channel and make sure it is clear.

Press and hold the **PTT** switch. Speak into the microphone area of the front panel grille in a normal voice level. To return to the Receive mode, release the **PTT** switch.

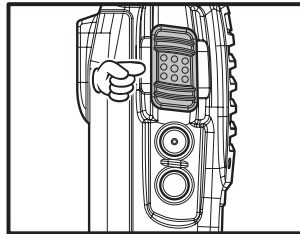

- ❑ Press (or press and hold) the **SIDE-1 SIDE-2** button, or front panel's programmable keypad (**[A]** - **[D]** key) to activate one of the pre-programmed functions which may have been enabled at the time of programming by the dealer. See the next chapter for details regarding feature availability for this radio.

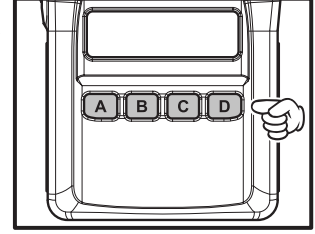
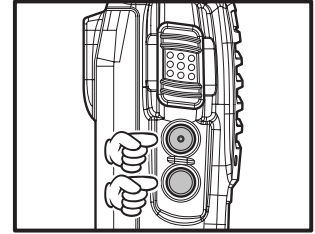

- ❑ If a Speaker/Microphone is available, remove the plastic cap and its two mounting screws from the right side of the transceiver, then align the connector of the Speaker/Microphone on the radio; secure the connector pin using the screws supplied with the Speaker/Microphone. Hold the speaker grille up next to your ear while receiving. To transmit, press the **PTT** switch

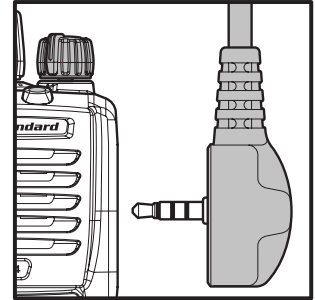

---

## OPERATION

---

on the Speaker/Microphone, just as you would on the main transceiver's body, and speak into the microphone on a normal voice level.

*Note 1): Save the original plastic cap and its mounting screws. They should be reinstalled when not using the Speaker/Microphone.*

*2) When you press the PTT switch on the Speaker/Microphone, it disables the internal microphone, and vice versa.*

- ❑ If the BCLO (Busy Channel Lockout) feature has been programmed on a channel, the radio will not transmit when a carrier is present. Instead, the radio will generate short beep three times. Release the **PTT** switch and wait for the channel to be clear of activity.
- ❑ If the BTLO (Busy Tone Lockout) feature has been programmed on a channel, the radio can transmit only when there is no carrier being received or when the carrier being received includes the correct tone (CTCSS tone or DCS code).

### Automatic Time-Out Timer

If the selected channel has been programmed for automatic time-out, you must limit the length of each transmission. While transmitting, a beep will sound 10 seconds before time-out. Another beep will sound just before the deadline; the top panel's red LED ("**TX**" indicator) will disappear and transmission will cease soon thereafter. To resume transmitting, you must release the **PTT** switch and wait for the "penalty timer" to expire.



---

## ADVANCED OPERATION

---

### Programmable Key Functions

The **VX-264** provides six programmable function (**PF**) keys: **SIDE-1**, **SIDE-2**, **[A]**, **[B]**, **[C]**, and **[D]** keys.

These **PF** keys can be customized, via programming by your Vertex Standard dealer, to meet your communications/network requirements.

The possible **PF** key programming features are illustrated on the next page, and their functions are explained beginning after page 18. For further details, contact your Vertex Standard dealer.

For future reference, check the box next to each function that has been assigned to the **PF** key on your particular radio, and keep it handy.

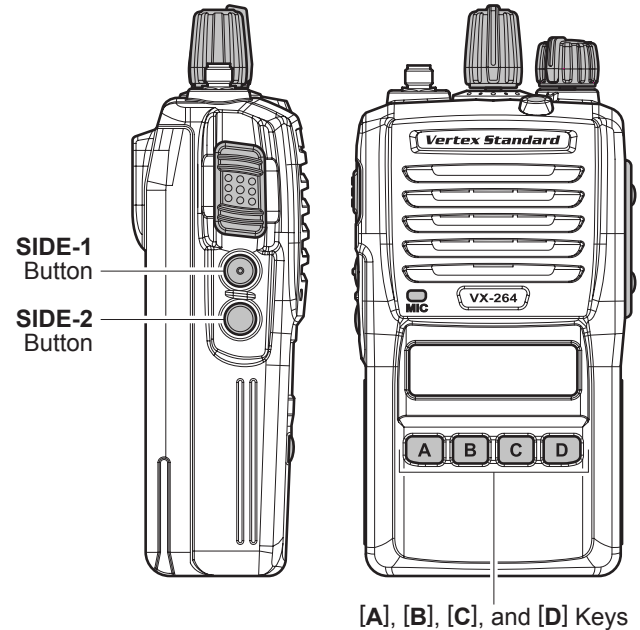

## ADVANCED OPERATION

FUNCTION	PROGRAMMABLE KEY (PRESS KEY / PRESS AND HOLD KEY)					
	SIDE-1	SIDE-2	[A]	[B]	[C]	[D]
None	/	/	/	/	/	/
Monitor	/	/	/	/	/	/
Monitor -Momentarily-	/—	/—	/—	/—	/—	/—
Lamp	/	/	/	/	/	/
Low Power	/	/	/	/	/	/
Encryption	/	/	/	/	/	/
SQL OFF	/	/	/	/	/	/
SQL OFF -Momentarily-	/—	/—	/—	/—	/—	/—
SQL Set	/	/	/	/	/	/
Beep OFF	/	/	/	/	/	/
Whisper	/	/	/	/	/	/
VOX	/	/	/	/	/	/
VOX Set	/	/	/	/	/	/
VOX Anti-Trip	/	/	/	/	/	/
Emergency	/—	/—	/—	/—	/—	/—
Lone Worker	/	/	/	/	/	/
Group Up	/	/	/	/	/	/
Group Down	/	/	/	/	/	/
Channel Up	/	/	/	/	/	/
Channel Down	/	/	/	/	/	/
PRI	/	/	/	/	/	/
Scan	/	/	/	/	/	/
Group Scan	/	/	/	/	/	/
Group Scan Set	/	/	/	/	/	/
Dual Watch	/	/	/	/	/	/
Follow-Me Scan	/	/	/	/	/	/
Scan Set	/	/	/	/	/	/
TA (Talk Around) Scan	/	/	/	/	/	/

## ADVANCED OPERATION

FUNCTION	PROGRAMMABLE KEY (PRESS KEY / PRESS AND HOLD KEY)					
	SIDE-1	SIDE-2	[A]	[B]	[C]	[D]
Talk Around	/	/	/	/	/	/
Reset	/	/	/	/	/	/
Call 1	/	/	/	/	/	/
Call 2	/	/	/	/	/	/
Call 3	/	/	/	/	/	/
Code Up	/	/	/	/	/	/
Code Down	/	/	/	/	/	/
Code Set	/	/	/	/	/	/
Speed Dial	/	/	/	/	/	/
Call	/	/	/	/	/	/
Duty	/	/	/	/	/	/
Tx Save Disable	/	/	/	/	/	/
Lock	/	/	/	/	/	/

---

## ADVANCED OPERATION

---

### Description of Operating Functions

#### **MONITOR**

Press, (or press and hold), the assigned **PF** key to cancel any signaling features; the LED indicator will glow green.

The “” icon will be indicated on the display, when the Monitor function is activated.

#### **MONITOR -MOMENTARILY-**

Cancel any signaling features while pressing the assigned **PF** key.

The “” icon will be indicated on the display while canceling any signaling features.

#### **LAMP**

Press, (or press and hold), the assigned **PF** key to toggle the back light of the display “On” and “Off”.

#### **LOW POWER**

Press, (or press and hold), the assigned **PF** key to set the radio’s transmitter to “Low Power” mode, thus extending battery life. Press, (or press and hold), the assigned **PF** key again to return to “High Power” mode when in RF impeding environments.

The “**L**” icon will be indicated on the display when the radio’s transmitter is set to “Low Power” mode.

#### **ENCRYPTION**

When the Voice Scrambler feature is enabled, press, (or press and hold), the assigned **PF** key to toggle the Voice Encryption “On” and “Off”.

The “” icon will be indicated on the display when the Voice Scrambler is activated.

#### **SQL OFF**

Press, (or press and hold), the assigned **PF** key to open the SQL to hear background noise (unmute the audio).

The “” icon will blink on the display when the SQL OFF function is activated.

#### **SQL OFF -MOMENTARILY-**

Opens the SQL to hear background noise (unmute the audio) while pressing the assigned **PF** key.

The “” icon will blink on the display while opening the SQL.

---

## ADVANCED OPERATION

---

### SQL SET

You can manually adjust the squelch level using this function:

- ❑ Press, (or press and hold), the assigned **PF** key. A tone will sound, and the current squelch level will appear on the display.
- ❑ Press the **SIDE-1/SIDE-2** buttons (or **[A]/[B]** keys) to select the desired squelch level. Available selections are “-8” to “+8”.
- ❑ Press the **[D]** key to store the new setting. The display indicates “- **SAVED** -” briefly, then reverts to the normal channel indication.

You may cancel the new setting by pressing the **[C]** key. In this case, the display indicates “- **CANCEL** -” briefly.

### BEEP OFF

Press, (or press and hold), the assigned **PF** key to disable any radio beeps temporarily. Press again, (or press and hold again), the assigned **PF** key to enable any radio beeps.

When the Beep Off function is “on” and “off”, the display indicates briefly “**BEEP OFF**” and “**BEEP ON**”.

### WHISPER

Press, (or press and hold), the assigned **PF** key to increase the microphone gain; allowing the operator to speak in a low voice (whisper) temporarily when transmitting. Press again, (or press and hold again), the assigned **PF** key to resume normal microphone gain.

When the Whisper function is “on” and “off”, the display indicates “**WHISP ON**” and “**WHISP OFF**” briefly.

### VOX (REQUIRES VOX COMPATIBLE HEADSET)

Press, (or press and hold), the assigned **PF** key to activate the VOX function; allowing hands-free, automatic activation of the transmitter, initiated by voice input into the microphone. You may disable the VOX function temporarily by pressing the **PTT** switch.

Press again, (or press and hold again), the assigned **PF** key to resume normal operation.

*Note 1:* when the VOX function is activated by operation from the external equipment, a small dot (“•”) will be indicated at the bottom right of the display (see page 11 of this manual).

*Note 2:* when the VOX function is “on” and “off”, the display indicates “**VOX ON**” and “**VOX OFF**” briefly.

---

## ADVANCED OPERATION

---

### VOX SET

You can manually adjust the VOX Gain using this function:

- ❑ Press, (or press and hold), the assigned **PF** key. A tone will sound, and the current VOX Gain level will appear on the display.
- ❑ Press the **[A]/[B]** button to select the desired VOX Gain level.
- ❑ Press the **[D]** key to store the new setting. The display indicates “- **SAVED** -” briefly, then reverts to the normal channel indication.

You may cancel the new setting by pressing the **[C]** key. In this case, the display indicates “- **CANCEL** -” briefly.

### VOX ANTI-TRIP

Press, (or press and hold), the assigned **PF** key to toggle the VOX Anti-Trip feature “On” and “Off”.

When the VOX Anti-Trip feature is set to “On”, the transceiver does not activate a VOX transmission from picking up receive audio or from a radio alert tone (beep sound).

When the VOX Anti-Trip feature is “on” and “off”, the display indicates “**ATRP ON**” and “**ATRP OFF**” briefly.

### EMERGENCY

The **VX-264** includes an “Emergency” feature which may be useful for alerting another party monitoring on the same frequency as your transceiver’s channel.

Press and hold the assigned **PF** key for a pre-programmed period to initiate an emergency call on the pre-defined channel. The “- **EMG** -” indication will be indicated on the display. For further details contact your Vertex Standard dealer.

To revive the radio from the Emergency mode, just press and hold again the assigned **PF** key or turn off the radio.

### LONE WORKER

Press, (or press and hold), the assigned **PF** key to activate the Lone Worker feature. The Lone Worker feature is designed to emit an alarm for 30 seconds when the Lone Worker Timer (programmed by your Vertex Standard dealer) has expired.

Press again, (or press and hold again), the assigned **PF** key, the Lone Worker feature is disabled. If the user does not reset the timer by pressing the **PTT** switch, the radio switches to Emergency mode.

When the Lone Worker feature is activated, a small dot (“•”) will be indicated at the bottom left of the display.

---

## ADVANCED OPERATION

---

### GROUP UP/DOWN

Press, (or press and hold), the assigned **PF** key to select a different group of channels. A group number will appear at the upper right corner and a group name will appear briefly on the display.

### CHANNEL UP/DOWN

Press, (or press and hold), the assigned **PF** key to select a different channel. A channel name will appear on the display.

### PRI

Press, (or press and hold), the assigned **PF** key to recall the pre-programmed Priority Channel of the current group by your Vertex Standard dealer directly. When Priority Channel is recalled, the “**P**” icon will appear on the display.

### SCAN

The Scanning feature is used to monitor multiple channels programmed into the transceiver. When scanning, the transceiver will check each channel for the presence of a signal and will stop on a channel if a signal is present.

#### *To activate scanning:*

- Press, (or press and hold), the assigned **PF** key to activate scan mode.
- The scanner will search the channels of the pre-programmed scan list, looking an active channel. The radio will pause each time it finds a channel on which someone is speaking.
- Press again, (or press and hold again), the assigned **PF** key to disable scanning and receive the channel which was chosen when pressed the **PF** key.

*Note:* Your dealer may have programmed your radio to stay on one of the following channels if you press the **PTT** switch during scanning pause:

- “Scan Pause” channel (“Talk Back”)
- “Last Busy” channel
- “Priority” channel
- “User Programmed” channel (“Select Channel”)
- The channel which defined in the **CH** Selector knob (“Channel Position”).

---

---

## ADVANCED OPERATION

---

---

### GROUP SCAN

Group Scan monitors channels in multiple groups, compared to the scan feature, which monitors channels in a single or current group. When scanning, the transceiver will check each channel of the programmed group for the presence of the signal and will stop on a channel if a signal is present.

Press, (or press and hold), the assigned **PF** key to activate group scan for the pre-programmed groups.

Press again, (or press and hold again), the assigned **PF** key to disable group scan mode and receive the channel which was chosen when pressed the **PF** key.

When the Group Scan is activated, the display indicates “**GRP SCAN**”.

### GROUP SCAN SET

You may wish to have the Scanner pass through more than one Group during the scanning process (normally, scanning is performed within the current group only).

To include the current Group in the scanning loop, press, (or press and hold), the assigned **PF** key: a small dot (“•”) will appear at the bottom of the display (See page 11 of this manual).

To remove a current Group from Group Scan, press, (or press and hold), the assigned **PF** key again: a small dot (“•”) will disappear from the display.

### DUAL WATCH

The Dual Watch feature is similar to the SCAN feature, except that only two channels are monitored:

- The current operating channel
- The Priority channel.

#### *To activate Dual Watch:*

- Press, (or press and hold), the assigned **PF** key to activate the Dual Watch feature.
- The scanner will search the two channels and pause when it finds a transmission on either channel.

When the Dual Watch feature is activated, the “**DW**” icon will be indicated on the display (See page 11 of this manual).

#### *To stop Dual Watch:*

- Press, (or press and hold), the assigned **PF** key to disable the Dual Watch feature.

The radio reverts back to the original channel being monitored before the dual watch feature was initiated.



---

## ADVANCED OPERATION

---

### FOLLOW ME SCAN

The Follow Me Scan feature checks a user-assigned priority channel in addition to the channels previously pre-programmed into a radio's scan list. For example, if only Channels 1, 3, and 5 (of the 8 available channels) are designated for "Scanning", the user may assign Channel 2 as the "user-assigned" priority channel via the Follow Me Scan.

To activate Follow Me Scan, first select the channel you want to designate as the "user-assigned priority channel" by positioning the **CH** Selector knob on the desired "priority" channel. Next, press, (or press and hold), the assigned **PF** key (the display will indicate "**FM SCAN**" briefly). Finally, rotate the **CH** Selector knob to the desired "operating channel".

The scanner will search the two channels (user-assigned priority channel and operating channel) and pause when it finds a transmission on either channel.

### SCAN SET

Press, (or press and hold), the assigned **PF** key to add/delete the current channel to/from your scanning list.

To store a particular channel to your scanning list, press, (or press and hold), the assigned **PF** key. If you delete a channel from your scanning list, press, (or press and hold), the assigned **PF** key again.

When the scanner is paused, you may remove the channel from the scan list temporarily by pressing, (or press and holding), the same key.

*Note 1:* when store a particular channel to your scanning list, the display indicates "**Scan Set**" briefly and "**U**" icon will appear on the display.

*Note 2:* when delete a channel from your scanning list, the display indicates "**Scan Skip**" briefly and the "**U**" icon will disappear from the display.

*Note 3:* To reset your scan list to its original pre-programmed settings, power the transceiver off, then on using the **VOL/PWR** knob.

---

## ADVANCED OPERATION

---

### TA (TALK AROUND) SCAN

Press, (or press and hold), the assigned **PF** key to toggle the TA Scan feature “On” and “Off”.

When operating on a duplex channel system (for example, a repeater station), TA Scan allows the transceiver to search both transmit and receive frequencies on your duplex system.

When a signal is encountered on the receive frequency, the transceiver will pause until the signal disappears. When a signal is encountered on the transmit frequency, the transceiver will check for activity on the receive frequency every few seconds (interval programmed by your Vertex Standard dealer).

When the TA Scan feature is activated, the “” icon will blink on the display (See page 11 in this manual).

**Note:** The TA Scan feature does not activate on a Simplex Channel.

### TALK AROUND

Press, (or press and hold), the assigned **PF** key to activate the Talk Around feature when you are operating on duplex channel systems (separate receive and transmit frequencies, utilizing a “repeater” station). The Talk Around feature allows you to bypass the repeater station and talk directly to a station that is nearby. This feature has no effect when you are operating on “simplex” channels, where the receive and transmit frequencies are already the same.

When the Talk Around feature is activated, the “” icon will be indicated on the display (See page 11 in this manual).

Note that your dealer may have mode provision for “Talk Around” channels by programming “repeater” and “Talk Around” frequencies on two adjacent channels. If so, the key may be used for one of the other Pre-Programmed Functions.

**Note:** The Talk Around feature does not activate on a Simplex Channel.

### RESET

Press (or press and hold) the assigned **PF** key to reset the RFC (Ready for Communication) condition.

---

## ADVANCED OPERATION

---

### CALL 1 TO CALL 3

Press, (or press and hold), the assigned **PF** key to send a pre-programmed 5-Tone call signal.

### CODE UP/DOWN

Press, (or press and hold), the assigned **PF** key to select a 2-Tone or 5-Tone encode code from the pre-programmed encode list.

### CODE SET

You can change the desired digit of the 5-Tone encode code using this function:

- Press, (or press and hold), the assigned **PF** key.
- Set the desired 5-Tone encode code from the **[A]/[B]** keys (select the code number) and **SIDE-1/SIDE-2** buttons (select the code digit).
- Press the **[D]** key to store the new setting. The display indicates “- **SAVED** -” briefly, then reverts to the normal channel indication.  
You may cancel the new setting by pressing the **[C]** key. In this case, the display indicates “- **CANCEL** -” briefly.

### SPEED DIAL

Your Vertex Standard dealer may have pre-programmed Auto-Dial telephone number memories into your radio.

To dial a number:

Press, (or press and hold), the assigned **PF** key, then press the **SIDE-1/SIDE-2** buttons (or **[A]/[B]** keys) to select the Auto-Dial memory name which recorded the dial number you wish. Press the **PTT** switch to send a pre-defined DTMF tone. The DTMF tones sent during the dialing sequence will be heard in the speaker.

### CALL

Press, (or press and hold), the assigned **PF** key to send a pre-programmed 2-Tone encode code.

---

## ADVANCED OPERATION

---

### DUTY

Press, (or press and hold), the assigned **PF** key to toggle the Duty function of the 2-Tone or 5-Tone “On” and “Off”.

When the Duty function is set to “On”, the display indicates “**Duty ON**” briefly and the user will always hear (depending on the sub-audio signaling) all traffic on the paging channel. The radio will sound the paging alert when it receives the programmed 2-Tone or 5-Tone.

When the Duty function is set to “Off”, the display indicates “**Duty OFF**” briefly and the user will NOT hear normal radio traffic on the paging channel. The radio will sound the paging alert and unmute only when it receives the programmed 2-Tone or 5-Tone.

### TX SAVE DISABLE

The Transmit Battery Saver helps extend battery life by reducing transmit power when a very strong signal from an apparently nearby station is being received. Caution is advised when using this feature, as your transmission power could degrade the audio heard by the receiving radios in your communication path.

Press, (or press and hold), the assigned **PF** key to disable the Transmit Battery Saver, if you are operating in a location where high power is almost always needed.

Press again, (or press and hold again), the assigned **PF** key, the Transmit Battery Saver activates to reduce the transmit power when a very strong signal from an apparently nearby station is being received.

When the Transmit Battery Saver is “on” and “off”, the display indicates “**TX SA ON**” and “**TX SA OFF**” briefly.

### LOCK

Press (or press and hold) the assigned **PF** key to lock the **CH** Selector knob, Programmable keys, and **PTT** switch.

---

---

## LOCK

---

---

In order to prevent accidental channel change or inadvertent transmission, various aspects of the **CH** Selector knob, Programmable keys, and **PTT** switch may be locked. The precise lockout configuration is programmed by your Dealer.

To activate the key locking, turn the radio off. Then, press and hold the **PTT** and **SIDE-2** key while turning the radio on again.

To cancel the key locking, repeat this process.

---

---

## ARTS™ (AUTO RANGE TRANSPOND SYSTEM)

---

---

This system is designed to inform the operator when you and another ARTS™-equipped transceivers and stations are within communication range using the DCS Encoder/Decoder.

During ARTS™ operation, when the radio receives an incoming ARTS™ signal, a short beep will sound and “**IN SERV**” (“In Service”) will be indicated on the display for 2 seconds. If you move out of range for more than two minutes, your radio senses that no signal has been received; a short triple-beep will sound and “**OUT SERV**” (“Out of Service”) will be indicated on the display for 2 seconds. If you move back into communication range, as soon as the other station transmits, a short beep will sound again and “**IN SERV**” (“In Service”) will be indicated again on the display for 2 seconds.



---

---

## OPTIONAL ACCESSORIES

---

---

<b>FNB-V133LI-UNI</b>	7.4V DC  , 1380 mAh Li-Ion Battery Pack
<b>FNB-V134LI-UNI</b>	7.4V DC  , 2300 mAh Li-Ion Battery Pack
<b>CD-58</b>	Desktop Charger
<b>PA-55</b>	AC Adapter for CD-58
<b>VAC-UNI</b>	Desktop Charger (CD-58 + PA-55)
<b>VAC-6058</b>	Multi-Unit Charger
<b>MH-360S</b>	Compact Speaker Microphone
<b>MH-450S</b>	Speaker Microphone
<b>MH-45B4B</b>	Noise Cancelling Speaker Microphone
<b>MH-37A4B-1</b>	Earpiece Microphone
<b>VCM-5</b>	Vehicular Charger Mounting Adapter for CD-58
<b>ATV-8A</b>	VHF Antenna (134-151 MHz)
<b>ATV-8B</b>	VHF Antenna (150-162 MHz)
<b>ATV-8C</b>	VHF Antenna (161-174 MHz)
<b>ATV-6XL</b>	VHF Antenna (Untuned)
<b>ATU-6A</b>	UHF Antenna (400-430 MHz)
<b>ATU-6B</b>	UHF Antenna (420-450 MHz)
<b>ATU-6C</b>	UHF Antenna (440-470 MHz)
<b>ATU-6D</b>	UHF Antenna (450-490 MHz)
<b>ATU-6F</b>	UHF Antenna (490-520 MHz)
<b>CN-3</b>	Antenna Adapter
<b>CLIP-20</b>	Belt Clip
<b>CE150</b>	PC Programming Software
<b>FIF-12</b>	USB Programming Interface
<b>CT-106</b>	Connection Cable for FIF-12
<b>CT-27</b>	Radio to Radio Cloning Cable

*Availability of accessories may vary; some accessories are supplied standard per local requirements, others may be unavailable in some regions. Check with your Vertex Standard Dealer for changes to this list.*

---

---

## WARRANTY POLICY

---

---

Vertex Standard warrants, to the original purchaser only, its Vertex Standard manufactured communications products against defects in materials and workmanship under normal use and service for a given period of time from the date of purchase.

Limited Warranty Details:

- North America customers (USA and Canada): <http://www.vertexstandard.com/lmr/warranty-terms.aspx>
- Customers outside of North America: contact the authorized Vertex Standard distributor in your country.

### DISPOSAL OF YOUR ELECTRONIC AND ELECTRIC EQUIPMENT

Products with the symbol (crossed-out wheeled bin) cannot be disposed as household waste.

Electronic and Electric Equipment should be recycled at a facility capable of handling these items and their waste by products.

In EU countries, please contact your local equipment supplier representative or service center for information about the waste collection system in your country.



Part 15.21: Changes or modifications to this device not expressly approved by Vertex Standard could void the user's authorization to operate this device.



No portion of this manual may be reproduced without the permission of Vertex Standard LMR, Inc.

Vertex Standard is a trademark of Vertex Standard LMR, Inc.  
All other trademarks are the property of their respective owners.

©2015 Vertex Standard LMR, Inc.  
All rights reserved.

**Vertex Standard LMR, Inc.**  
4-6-8 Shibaura, Minato-ku, Tokyo 108-0023, Japan

