

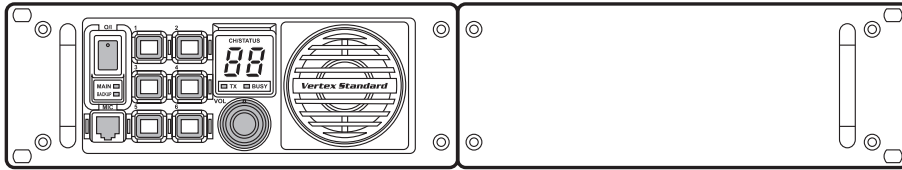

RACK MOUNT REPEATER
VXR-9000E
OPERATING MANUAL

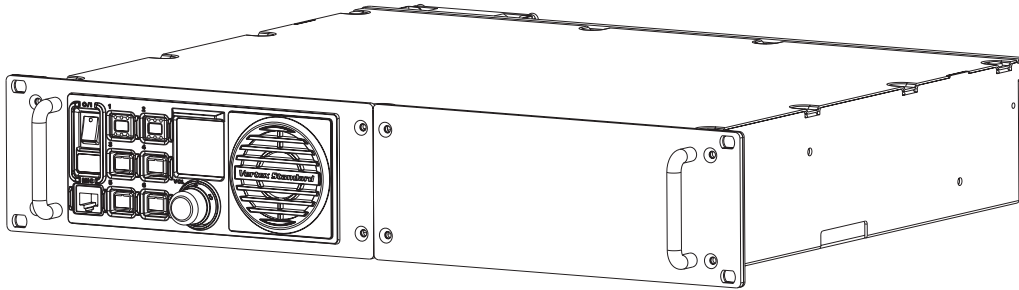

Vertex Standard LMR, Inc.



The **VXR-9000E** is commercial-grade 25-watt FM repeater designed to provide reliable two-way full-duplex communications over a wide range of environmental conditions.

Designed to mount in a standard 19-inch rack, the **VXR-9000E** is crafted using the latest computer-aided design and manufacturing processes, to ensure a high level of reliability to users. Important channel frequency data is stored in EEPROM, and is easily programmable by a Servicing Technician or Dealer using an IBM compatible personal computer and the **FIF-10A** (or **FIF-12**) + **CT-104A** USB Programming Interface and **CE60** Software.

Please take a few minutes to read this manual carefully. The information presented here will allow you to derive maximum performance from your **VXR-9000E**. After reading it, keep this manual handy for quick reference, in case questions arise later on.

Important Note: Internal service work, programming, and accessory installations should only be performed by your authorized Vertex Standard Dealer. Dangerous conditions and/or possibly illegal operation may result from improper setup, programming, or internal modifications.

SAFETY/WARNING INFORMATION

The antenna(s) used for this transmitter must be fixed-mounted on outdoor permanent structures with a separation distance of at least 74 cm from all persons during normal operation and must not exceed an antenna gain of 0 dBd. This device must be restricted to work related operations in an Occupational/Controlled RF exposure Environment, not exceeding a maximum transmitting duty factor of 50%. The antenna(s) used with this device must satisfy the antenna co-location requirements of 47 C.F.R. 1.1307(b)(3).

NOTICE!

- Do not modify this repeater for any reason.
Refer service of this repeater to qualified technicians only.
- When the repeater become abnormal, such as the overheating, smoke smell of burning, etc., turn the main power switch off and disconnect the Main Power Source connector from the rear of the **VXR-9000E** immediately. Also disconnect any backup power source you may have connected to the rear of the **VXR-9000E**.
- Do not place any combustible material near the repeater.
- Do not spray any liquid over the repeater.
- Ensure that the power and antenna connections are securely made, using cables with excess capacity for the power being utilized.

FRONT PANEL CONTROLS & CONNECTORS

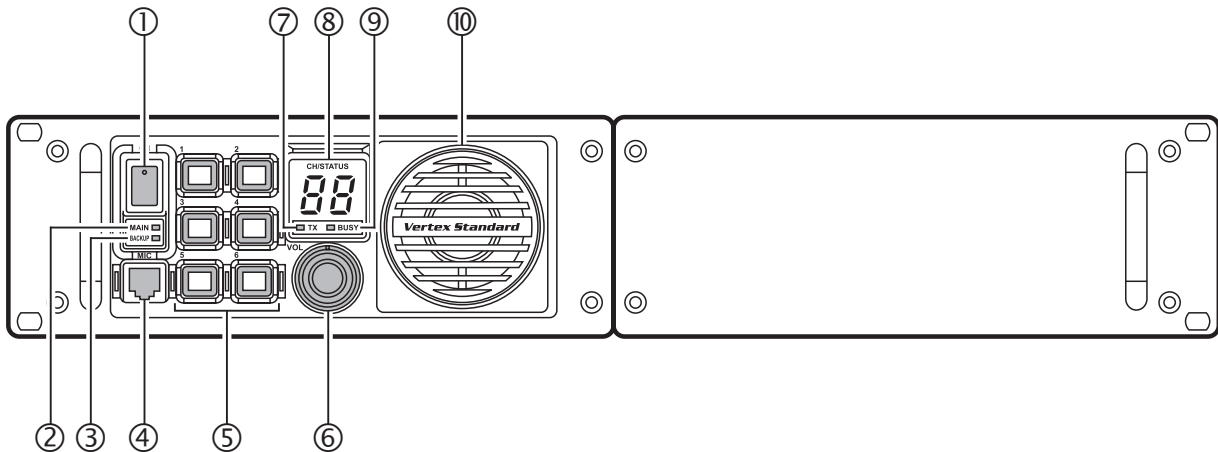

① POWER (O/I) Switch

This is the main power switch for the repeater.

② Power Indicator (**MAIN**)

This LED glows green when the main power source is used.

③ Power Indicator (**BACKUP**)

This LED glows red when the backup power source is used.

④ MIC Jack

Connect the microphone plug to this jack. This jack is also used for writing and reading channel frequency or other configurations via the USB Port of the PC on which the clone editor (**CE60**) is running.

⑤ Programmable Function (**PF**) Key

Six push buttons on the front panel are Programmable Function (**PF**) keys, each with an orange indicator inside. Each key can be programmed with two functions, one for a "long" press and one for a "momentary" press. The **PF** key functions may be customized, via programming by your VERTEX STANDARD dealer, to meet your communications network requirements. Note that some functions may require the purchase of optional internal accessories. The possible **PF** key features and functions are explained on the pages to follow.

⑥ VOL Knob

This control knob adjusts the output level of the front speaker and external speaker jack on the back panel.

⑦ TX Indicator

This LED glows red when the repeater is transmitting.

⑧ Numeric Display

This display consists of two 7-segment LEDs, indicating the channel number during normal operation. If an abnormal condition arises, an error code will be displayed:

DISPLAY	DESCRIPTION
01 - 30	Channel Number
PC	Clone Active
UL	PLL Unlock
HI	High temperature in PA Unit
SC	Scan Active
LC	Front Panel Keys are locked
E1	PTT key is disabled
E2	Cooling Fan is disabled
E5	Low Voltage in Backup Battery
E7	PA Unit Abnormality
E3, E4, E6, E9	Contact your dealer

⑨ BUSY Indicator

This LED glows green when the receiving channel is busy.

⑩ Speaker

The internal speaker is located here.

PROGRAMMABLE FUNCTION (PF) KEY DETAILS

FUNCTION	PF-1 KEY		PF-2 KEY		PF-3 KEY		PF-4 KEY		PF-5 KEY		PF-6 KEY	
	PRESS	PRESS & HOLD	PRESS	PRESS & HOLD	PRESS	PRESS & HOLD	PRESS	PRESS & HOLD	PRESS	PRESS & HOLD	PRESS	PRESS & HOLD
CH Down												
CH Up												
Compander												
CTCSS/DCS Enc												
CTCSS/DCS Dec												
CW ID												
Two Tone Dec												
CW ID Signal												
CW Message 1												
CW Message 2												
CW Message 3												
CW Message 4												
CW Message 5												
CW Message 6												
CW Message 7												
CW Message 8												
DC Power Save												
Encryption												
Encryption Code												
Key Lock												
Local PTT												
Monitor												
Monitor M		/	/	/	/	/	/	/	/	/	/	/
Multi Tone												
Panel Indicator												
Remote												
Repeat												
Reset												
Scan												
Squelch												
Test Tone												
Test Tone M		/	/	/	/	/	/	/	/	/	/	/
TOT												
Transmit												
TX Power Mid												
TX Power Low												

CH DOWN

Press (or Press and hold in for one second) the **PF** key assigned to “CH Down” to step to the next-lower operating channel.

CH UP

Press (or Press and hold in for one second) the **PF** key assigned to “CH Up” to step to the next-higher operating channel.

COMPANDER

Press (or Press and hold in for one second) the **PF** key assigned to “Compander” to turn the Compander circuit “On” or “Off” (toggle). This function is only activated on the “Narrow Channel Spread” of the “**Base Transceiver**” mode.

The Compander IC contains two variable gain circuits configured for compressing and expanding the dynamic range of the repeater’s transmitted and received audio signal. When you enable this function, the signal-to-noise ratio can be improved by reducing the transmitted audio dynamic range.

CTCSS/DCS ENC

Press (or Press and hold in for one second) the **PF** key assigned to “CTCSS/DCS Enc” to turn the CTCSS/DCS Encoder “On” or “Off” (toggle).

CTCSS/DCS DEC

Press (or Press and hold in for one second) the **PF** key assigned to “CTCSS/DCS Dec” to turn the CTCSS/DCS Decoder “On” or “Off” (toggle).

CW ID

Press (or Press and hold in for one second) the **PF** key assigned to “CW ID” to turn the CW Identifier feature “On” or “Off” (toggle).

When the CW ID feature is set to “On,” your station’s callsign will be superimposed on the outbound signal, in Morse Code, at the beginning of every transmission. Programming of the callsign is performed by your Vertex Standard dealer.

PROGRAMMABLE FUNCTION (PF) KEY DETAILS

TWO TONE DEC

Press (or Press and hold in for one second) the **PF** key assigned to “Two Tone Dec” to turn the 2-Tone Decoder “On” or “Off” (toggle).

CW ID SINGLE

Press (or Press and hold in for one second) the **PF** key assigned to “CW ID Single” to send the station callsign, via Morse Code, once. Programming of the callsign is performed by your Vertex Standard dealer.

CW MESSAGE 1 - CW MESSAGE 8

Press (or press and hold in for one second) the **PF** key assigned to “CW Message 1 - 8” to send a pre-programmed Morse Code message on the transmitted signal. Programming of the message(s) is performed by your Vertex Standard dealer.

DC POWER SAVE

Press (or Press and hold in for one second) the **PF** key assigned to “DC Power Save” to turn the DC Power Save feature “On” or “Off” (toggle).

When DC Power Save feature is set to “ON,” activate the various power save feature (determined from your Vertex Standard dealer) while the repeater operates from the Backup Power Source.

ENCRYPTION

Press (or Press and hold in for one second) the **PF** key assigned to “Encryption” to turn off the Optional Encryption Unit temporarily.

ENCRYPTION CODE

Press (or Press and hold in for one second) the **PF** key assigned to “Encryption Code” to select the Encryption Code (determined from your Vertex Standard dealer; require the **FVP-35** Rolling Code Encryption Unit).

KEY LOCK

Press (or Press and hold in for one second) the **PF** key assigned to “Key Lock” to lock the repeater’s front panel keys (except “Key Lock” key); this feature can be enabled to prevent repeater settings from being disturbed.

LOCAL PTT

Press (or Press and hold in for one second) the **PF** key assigned to “Local PTT” to enable (“On”) or disable (“Off”) operation using a **PTT** switch connected to the front panel’s Microphone Jack.

MONITOR

Press (or Press and hold in for one second) the **PF** key assigned to “Monitor” to cancel CTCSS and DCS squelch decoding, so as to enable reception of signals present on the channel that do not contain a matching CTCSS tone or DCS code.

MONITOR M

This function provides to “Monitor” to cancel CTCSS and DCS squelch decoding, so long as the **PF** key assigned to “Monitor M” is pressed and held in.

MULTI TONE

Press (or Press and hold in for one second) the **PF** key assigned to “Multi Tone” to switch the Tone Table between “Main” and “Sub.”

PANEL INDICATOR

Press (or Press and hold in for one second) the **PF** key assigned to “Panel Indicator” to turn the Front Panel’s Illumination “On” or “Off” (toggle).

REMOTE

Press (or Press and hold in for one second) the **PF** key assigned to “Remote” to toggle the operating mode between the “**Remote**” mode and “**Local**” mode.

When the “**Remote**” mode is selected, the repeater operates according to the control instructions received from the external device (connected to the **ACC** jack on the rear panel). While in the “**Local**” mode, the repeater operates from the front panel’s **PF** keys.

REPEAT

Press (or Press and hold in for one second) the **PF** key assigned to “Repeat” to toggle the operating mode between the “**Repeater**” mode and “**Base Transceiver**” mode.

For normal operation, set this key to the “**Repeat**” mode. When the “**Base Transceiver**” mode is selected, you can speak into the microphone to use this repeater as a transceiver.

RESET

Press (or Press and hold in for one second) the **PF** key assigned to “Reset” to reset (same function as the **POWER** switch “off” and “on”) the repeater.

PROGRAMMABLE FUNCTION (PF) KEY DETAILS

SCAN

Press (or Press and hold in for one second) the **PF** key assigned to "Scan" to start scanning. To stop scanning, press (or Press and hold in for one second) this key again.

The scanning feature is used to monitor multiple channels programmed into the repeater.

This function is only activated on the "**Base Transceiver**" mode.

SQUELCH

Press (or Press and hold in for one second) the **PF** key assigned to "Squelch" to override the Squelch action (CTCSS, DCS, and Noise Squelch), so as to hear any signal present on the operating channel.

TEST TONE

Press (or Press and hold in for one second) the **PF** key assigned to "Test Tone" to generate the Test Tone Signal, as programmed by your Vertex Standard dealer.

Press (or Press and hold in for one second) this key again to stop the generation of the Test Tone. This is a toggle function.

Press (or Press and hold in for one second) this key while press and holding the **PTT** switch to transmit the Test Tone Signal, as programmed by your Vertex Standard dealer.

TEST TONE M

This function provides momentary generation of the above-referenced Test Tone signal, so long as the **PF** key assigned to "Test Tone M" is pressed and held in.

Press this key while press and holding the **PTT** switch to transmit the Test Tone Signal, as programmed by your Vertex Standard dealer.

TOT

Press (or press and hold in one second) the **PF** key assigned to "TOT" to turn the Time-Out Timer feature "On" or "Off" (toggle).

When the TOT feature is set to "On," the repeater will return to the "Receive" mode automatically after a preset time of continuous transmission (determined via programming by your Vertex Standard dealer).

TRANSMIT

Press (or Press and hold in for one second) the **PF** key assigned to "Transmit" to enable ("On") or disable ("Off") the transmission of the **VXR-9000E**.

TX POWER MID

Press (or Press and hold in one second) the **PF** key assigned to "TX Power Mid" to set the transmitter power to the "Mid" level.

Press (or press and hold in one second) this key again to return to the "Original" power level (determined via programming by your Vertex Standard dealer).

This function is ignored on the channel which is programmed to the transmitter power to the "Mid" or "Low" level by your Vertex Standard dealer.

TX POWER LOW

Press (or Press and hold in one second) the **PF** key assigned to "TX Power Low" to set the transmitter power to the "Low" level.

Press (or press and hold in one second) this key again to return to "Original" power level (determined via programming by your Vertex Standard dealer).

This function is ignored on the channel which is programmed to the transmitter power to the "Low" level by your Vertex Standard dealer.

REAR PANEL CONNECTORS

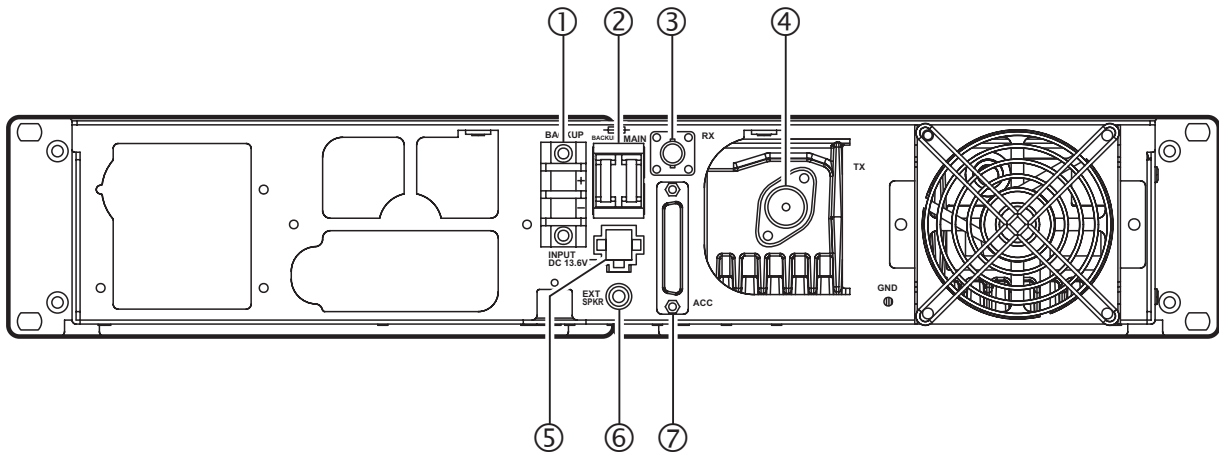

① Backup Power Source Terminals

If available, a backup 13.6 Volt power source, such as a rechargeable battery, may be connected here.

When the Battery Charge switch (located on the PA Unit) is set to "ON," a "trickle" charge current is present here while the repeater is operating from the "Main Power Source."

② Circuit Protection Fuse

Two 10-Amp (VHF model) or 15-Amp (UHF model) blade fuses, for the "Main" and "Backup" power sources, are installed here.

③ RX Antenna Jack

This BNC-type coaxial jack accepts the receiver input signal, for connection to the receiving antenna, or the "RX" jack on the duplexer. The input impedance requirement is 50 Ohms.

④ TX Antenna Jack

This N-type coaxial jack provides the transmitter output signal, for connection to the transmitting antenna, or the "TX" jack on the duplexer. The output impedance requirement is 50 Ohms.

 **Warning:** The 50 V RF voltage (@25 W/50 Ohms) is applied to the TX RF section of the repeater while transmitting.

Do not touch the TX RF section absolutely while transmitting.

⑤ Main Power Source Connector

The primary DC power source should be connected here. The power requirements are 13.6 V DC at 12 Amps, continuous duty.

⑥ External Speaker Jack

This 3.5-mm, 2-pin jack provides variable audio output for an external speaker. The audio output impedance at this jack is 4 to 16 Ohms, and the level varies according to the setting of the front panel's **VOL** knob.

⑦ DSUB 25-pin Accessory Connector

This DB-25F connector allows the repeater to be remote-controlled by an external controller. Analog I/O signals, such as TX Audio In, Discriminator Output, RSSI, etc. are available. Moreover, the **VXR-9000E** provides eight ports that can be programmed for various input or output signals, or for control functions. Each port may be programmed as to its function, its status (input or output), and its logic (for output ports only).

DB-25 CONNECTOR PORT

The **VXR-9000E** repeater is provided with a 25-pin DB-25F female connector for interconnections to accessories. Use a DB-25M 25-pin male connector to connect accessories to the repeater. The pins on the accessory connector are explained in detail as follows:

PIN 1: GND

Chassis ground for all logic levels and power supply return.

PIN 2: +13.6 V

[POWER SUPPLY]

This pin provides 13.6 Volts, 2.0 A, DC from the repeater supply. There is an internal 3 A fuse to prevent damage to the repeater.

PIN 3: TX AF IN

[ANALOG TRANSMITTER INPUT] (VOICE BAND: 300 ~ 3,000 Hz)

This pin is audio input. Input impedance is 600 Ohms. This audio is injected before the splatter filter stage, so excess signal input levels are clipped.

Use shielded cable to connect to this pin, and connect the shield to **GND**.

PIN 4: TONE IN

[TRANSMITTER INPUT] (SUB-AUDIBLE BAND: 5 ~ 250 Hz)

This pin is sub-audible input. The input is high impedance (approx. 22 k-ohms), and has a flat response characteristic (repeater deviation is constant for a given signal level over the frequency range of 5 ~ 250 Hz). Injecting too high a voltage here causes over-deviation of CTCSS or DCS, degrading performance.

Use shielded cable to connect to this pin, connecting the shield to **GND**.

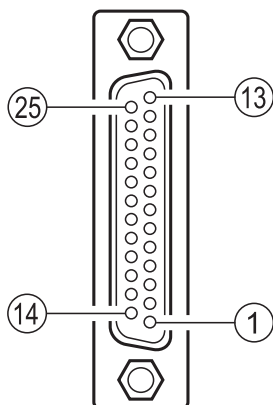

DB-25 PIN NUMBERING

PIN 5: TX ATT

This output is intended for controlling an external coaxial switching relay. It is an open drain output which can sink approx. 1.5 A when active. The delay time which is between the repeater cause to transmit mode and this port switches to ground can be programmed by your Vertex Standard dealer.

PIN 6: DISC OUT

[ANALOG OUTPUT] (WIDE-BAND: 0 ~ 3,000 Hz)

Received signals with standard deviation produce 350 mVrms audio at this pin. The output impedance is 600 Ohm, and is extracted before the de-emphasis and squelch circuitry. Use shielded cable to connect to this pin, and connect the shield to **GND**.

PIN 7: N.C.

No connection.

PIN 8: RSSI

[ANALOG OUTPUT]

A DC voltage proportional to the strength of the signal currently being received (**Receiver Signal Strength Indicator**) is provided on this pin. This low impedance output is generated by the receiver IF sub-system and buffered by an internal op-amp. Typical voltages are graphed as follows:

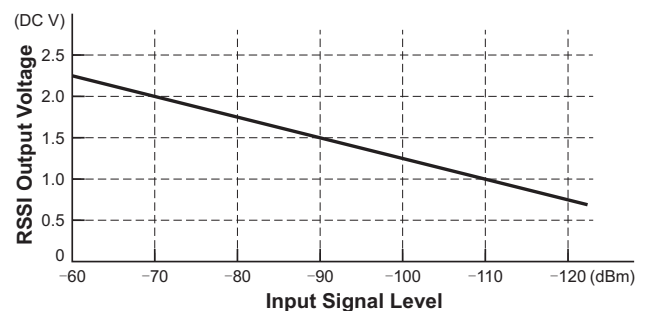

PIN 9: COAX. SW

[LOGIC OUTPUT (ACTIVE LOW)]

This output is intended for controlling an external coaxial switching relay. It is an open drain output which can sink approx. 1.5 A when active. This signal only switches if the repeater has been programmed for "**SIMPLEX**" mode. If programmed for "**DUPLEX**," the signal remains open (high impedance) at all time.

DB-25 CONNECTOR PORT

PIN 10, 13, 15, 16, 17, 18, 19, 21:

PROGRAMMABLE I/O "1" ~ "8"

The **VXR-9000E** provides eight ports (PIO) that can be programmed for various input or output signals, or for control functions. Each port may be programmed as to its function, its status (input or output), and its logic (for output ports only).

Pin	I/O Port
10	7
13	8
15	5
16	4
17	3
18	2
19	1
21	6

PIN 11: NSQ DET

This is an open-collector, active-low output capable of sinking about 10 mA. It indicates that the receiver squelch is open. If the squelch control is properly set, this indicates a carrier on the receiver channel.

PIN 12: EXT PTT

This input is internally pulled up to 5 VDC. When pulled low by an external device, it keys the repeater transmitter while the repeater is operating in the "Remote" mode. Avoid voltage in excess of 5 V on this pin, or internal damage to the microprocessor on the repeater CNTL Unit may result.

PIN 14, 20: GND

Chassis ground for all logic levels and power supply return.

PIN 22: RXD LOW

[ANALOG OUTPUT FOR DATA COMMUNICATIONS] (300 ~ 3,000 Hz)

This pin is an output for low speed receiving data signals, with the data being extracted after the de-emphasis and low pass filter stages.

PIN 23: RXD HIGH

[DIGITAL OUTPUT FOR DATA COMMUNICATIONS]

This pin is an output for high speed receiving data signals, with the data being extracted immediately after the discriminator (prior to any de-emphasis).

PIN 24: TXD LOW

[ANALOG INPUT FOR DATA COMMUNICATIONS] (300 ~ 3,000 Hz)

This pin is intended to be used as a low speed data signal input to the repeater. This digital data signal is injected before the transmitter pre-emphasis and limiting stages, so excess signal input levels are clipped.

PIN 25: TXD HIGH

[DIGITAL INPUT FOR THE DATA COMMUNICATIONS]

This pin is intended to be used as a high speed digital data signal input to the repeater. This digital data signal is injected after the transmitter splatter filter stage.

Antenna Considerations

Repeater operation requires two antennas, one for receiving and one for transmitting, so that the receiving antenna does not absorb energy from the transmitting antenna. There are a number of ways to do this, depending on the TX/RX frequency separation, and on the locations available for antenna mounting.

Regardless of the above choice, it is of paramount importance that the antenna(s) be mounted as high and in the clear as possible, preferably within line-of-sight to all repeater users. Furthermore, losses in the feedline(s) must be minimized, so the feedline(s) should be high quality, and as short as possible. If a long feedline is necessary, use coaxial "hardline" cable to reduce losses.

Repeater antennas should have an impedance of 50 Ω at the operating frequency. When separate receive and transmit antennas are used, high-Q narrow-band types may serve to minimize interaction.

NEVER TRANSMIT WITHOUT HAVING A TRANSMIT ANTENNA CONNECTED TO THE TX ANTENNA JACK OF THE REPEATER.

Equipment Location

The **VXR-9000E** must be installed in a 19-inch Mounting Rack, which will allow for free air flow around the heat sink on the rear apron at all times. In warm climates, the repeater should not be sealed in a small, closed room without air conditioning.

While the operating temperature range of the **VXR-9000E** is quite broad, the best location is one in which the air temperature does not approach the extremes of the specified range, and one that does not change rapidly.

Protect the **VXR-9000E** (Mounting Rack) from wind and rain, and extremes in temperature or humidity that may shorten the useful life of the equipment. Try to locate the **VXR-9000E** (Mounting Rack) in an environment that is also comfortable for service personnel, if possible.

INSTALLATION

Power Supply

Operation of the **VXR-9000E** requires a power source capable of providing at least 8 Amps continuously at 13.6 Volts DC. The **FP-1030** (External) and **FP-31** (Internal) AC Power Supplies are available from your Vertex Standard dealer to satisfy these requirements. Other well-regulated power supplies may be used, as well, if they meet the above voltage and current specifications.

Use the DC power cable supplied with your repeater for making power connections to the power supply. Connect the RED power cable lead to the POSITIVE (+) power supply terminal, and connect the BLACK power cable lead to the NEGATIVE (-) power supply terminal.

Backup Power Supply

For uninterrupted operation during power failures, a 12-volt rechargeable type battery (55-Ah or more recommended) may be connected to the **BACKUP** terminal posts on the rear panel. While the repeater is operating from the Main Power Source a slight charging current will maintain battery charge. In the event of an unexpected interruption of the Main Power Source, the automatic power control circuit will automatically switch the repeater to the backup battery, and operation will not be interrupted.

After prolonged operation from the battery, (Backup Power Source), it should be disconnected from the repeater and recharged separately before re-connecting, as the trickle charge is not sufficient for recharging a completely discharged battery.

Never reapply the Main Power Source to the repeater with a discharged battery connected as backup, as the DC startup current can damage the repeater and battery.

Never short the "Backup Power Source" Terminals, when the Battery Charge switch (located on the PA Unit) is set to "ON."

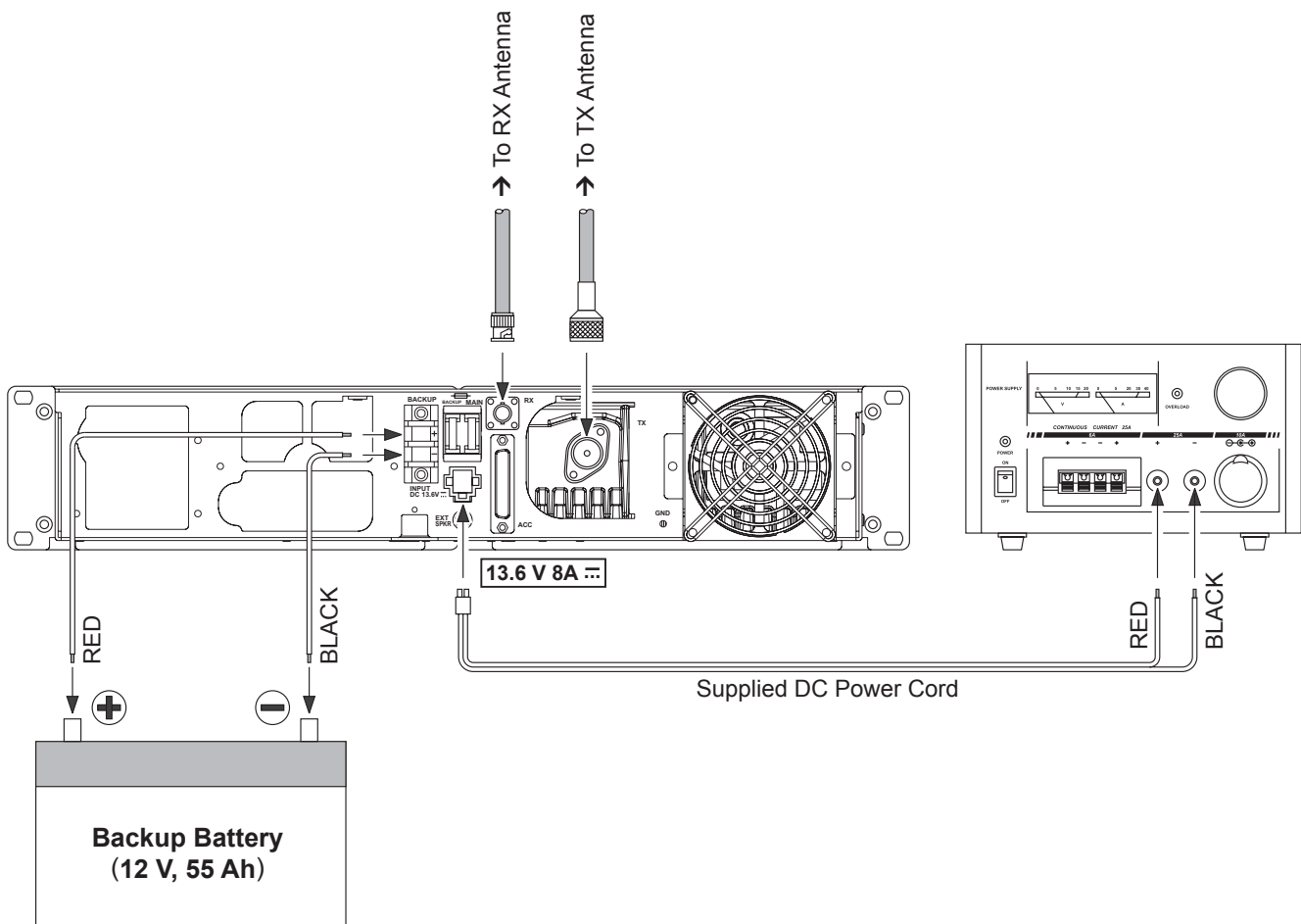

TYPICALLY SETUP

Supplied Accessories

DC Power Cord (T9023499)	1
Blade Fuse	1
VHF Model: 10-A (Q0000112)	
UHF Model: 15-A (Q0000075)	
Knob Cap (RA0506900)	6
Name Plate (RA0508500).....	1
Operating Manual.....	1

Optional Accessories

MD-12A8J	Desktop Microphone
MH-53A8J	Noise-Canceling Microphone
FP-31	AC Power Supply Unit
FIF-9	Inline Interface Box
FVP-25	Encryption Unit
FVP-35	Rolling Code Encryption Unit
FIF-10A	USB Programming Interface
FIF-12	USB Programming Interface
CT-104A	PC Programming Cable (for FIF-10A and FIF-12)

DISPOSAL OF YOUR ELECTRONIC AND ELECTRIC EQUIPMENT

Products with the symbol (crossed-out wheeled bin) cannot be disposed as household waste.

Electronic and Electric Equipment should be recycled at a facility capable of handling these items and their waste byproducts.

In EU countries, please contact your local equipment supplier representative or service center for information about the waste collection system in your country.





No portion of this manual may be reproduced without the permission of Vertex Standard LMR, Inc.

Vertex Standard is a trademark of Vertex Standard LMR, Inc.
All other trademarks are the property of their respective owners.

©2015 Vertex Standard LMR, Inc.
All rights reserved.

