

22/5-1985

Belcom LS-202E

SSB&FM HANDY TRANSCEIVER

OPERATING MANUAL

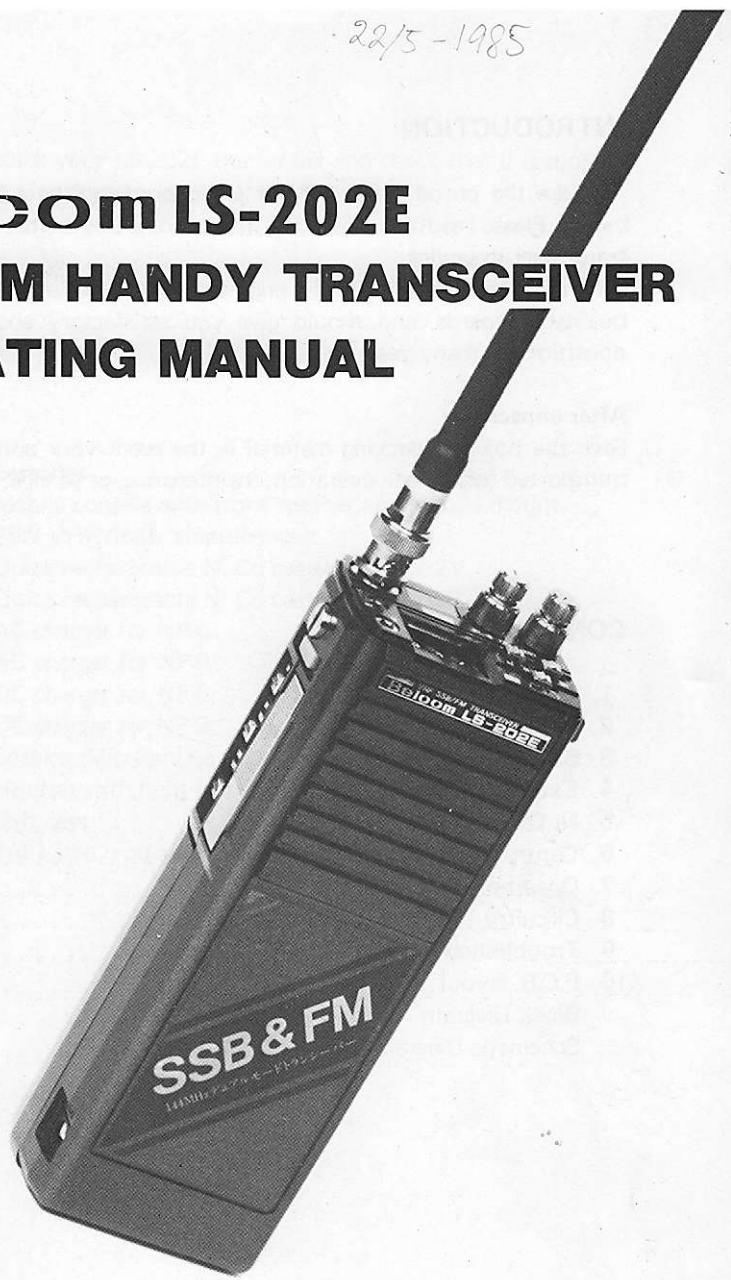

INTRODUCTION

You are the proud owner of our latest product, the LS-202E Transceiver. Please read this operating manual carefully before placing your transceiver in service.

The unit has been carefully engineered and manufactured to rigid quality standards, and should give you satisfactory and dependable operation for many years.

After unpacking

Save the box and packing material in the event your unit needs to be transported for remote operation, maintenance, or service.

CONTENTS

1. Specifications	2
2. Battery Installation	4
3. Battery Note	5
4. External Power Supply	6
5. Ni-Cd Battery Pack, NP-6, NP-9	6
6. Controls and Terminals	7
7. Operation	12
8. Circuitry	12
9. Troubleshooting	17
10. P.C.B. layout	18
Block Diagram	20
Schematic Diagram (MAIN, PLL)	22

Accessories

Carefully unpack your LS-202E transceiver and check that it is supplied with the following accessories.

Rubber Flex Antenna	1
Belt Clip	1
Hand Strap	1
Operating Manual	1

Optional Accessories

LA-207	Mobile console with front speaker and mobile mount.
LU-2	25W VHF linear amplifier unit.
NP-6	Quick rechargeable Ni-Cd battery pack 7.2V.
NP-9	Quick rechargeable Ni-Cd battery pack 10.8V
CA-910E	AC charger for NP-6
CA-110E	AC charger for NP-9
CS-912	DC charger for NP-6
CS-112	DC charger for NP-9
SH-1	Speaker/Microphone
SH-2	Headset with built-in VOX
SFT-207	Soft case
AN-2	1/4 λ BNC rod antenna

SPECIFICATIONS

GENERAL

Frequency Range:	144.000-145.995 MHz in 5KHz steps (up to 147.995 MHz possible) SSB VXO ± 5 kHz or more
Mode:	F3(FM), A3J (SSB)
Frequency Stability:	± 20 ppm ($-10^{\circ}\text{C} - +60^{\circ}\text{C}$)
Operating Voltage Range:	7V – 12V DC (9V nominal)
Grounding:	Negative
RF Output Impedance:	50 ohm unbalanced
Current Drain: (at 9V)	30mA in receive mode with no input signal 200mA in receive mode with maximum signal 750mA in transmit mode with FM 200mA in non-modulated SSB 700mA in modulated SSB
Dimensions:	165(H) x 62(W) x 40(D) mm excluding projections 179(H) x 64(W) x 44(D) mm including porjections
Weight:	Approx. 500 g including batteries and a flexible rubber antenna
Operating Temperature:	$-10^{\circ}\text{C} - +60^{\circ}\text{C}$

TRANSMITTER

RF Power Output:	Hi = 2.5W (at 9V) SSB (PEP), FM 3.5W (at 10.8V) 1.5W (at 7.2V) Lo = 0.5W (at 9V)
Modulation:	SSB = Balanced Modulation FM = Reactance Direct Shift
Bandwidth:	Less than 3kHz SSB
Maximum Frequency Deviation:	± 5 kHz FM

Spurious Radiation: Better than -60 dB
Carrier Suppression: Better than 40 dB
Microphone: 2 Kohm Built-in Electret Condenser
microphone

RECEIVER

Circuitry: FM = Double Conversion
Superheterodyne
SSB = Single Conversion
Superheterodyne

Intermediate Frequency: 1st IF = 10.695 MHz (FM, SSB)
2nd IF = 455 kHz (FM)

Sensitivity: FM = -12dB μ Better than 0.25 μ V
(S/N = 10 dB)
SSB = -12dB μ Better than 0.25 μ V
(SINAD = 12 dB)

Spurious Response: Better than 60 dB

RIT Control: more than \pm 1 kHz

Selectivity: FM = \pm 7.5 kHz/-6 dB,
 \pm 15 kHz/-60 dB
SSB = \pm 1.2 kHz/-6 dB,
 \pm 3 kHz/-60 dB

AF Output Power: More than 400 m W (10% distortion,
8 ohm loading)

* Circuit and ratings may change without notice due to development in technology.

2. BATTERY INSTALLATION

1) Battery installation

Insert the six AA size batteries (high power leakproof type recommended) into the battery case as shown in the diagram. Be very careful to observe battery polarity when installing. When the batteries are failing, replace all six batteries with new ones of the same type.

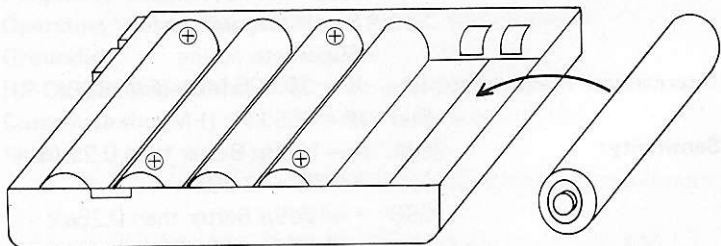

* Be sure to insert batteries with correct polarity.

2) Battery loading

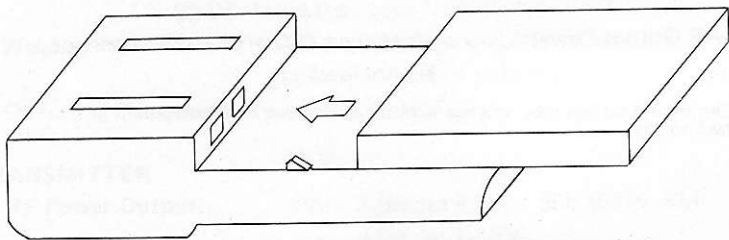

To load the battery case, slide the case onto the transceiver until the catch engages ("clicks") as shown in the diagram.

3) Operating time

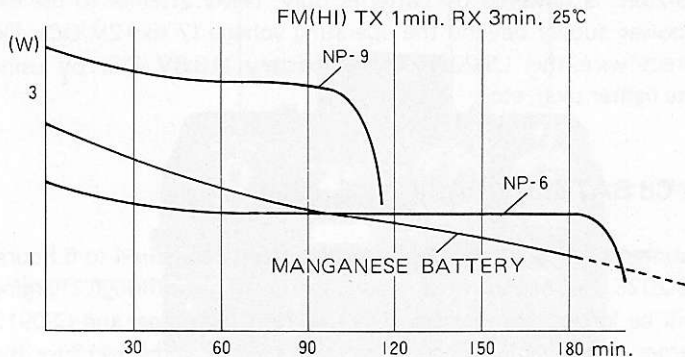

The voltage/power versus time characteristics is shown in the above illustration. SSB operation normally extends battery life 3 to 4 times longer than FM. Also, use of low power reduces battery consumption resulting in longer operating life.

3. BATTERY NOTE

- 1) When loading, ascertain that battery polarity is correct.
- 2) Never use old and new batteries mixed, nor mix batteries of different type.
- 3) Never try to charge normal type dry batteries or alkaline batteries.
- 4) Manganese and alkaline batteries reduce in capacity at low temperatures (less than 10°C), and it becomes necessary to keep the batteries warm to enable normal operation.
- 5) It is advisable to use the optional NP-6 or NP-9 Ni-Cd battery pack for more satisfactory and longer battery life.

4. EXTERNAL POWER SUPPLY

The LS-202E is powered by batteries only. Never attempt to use external power supply beyond the operating voltage (7 to 12V DC). Do not direct wire the LS-202E to car battery (13.8V DC) by using cigarette lighter plug, etc.

5. Ni-Cd BATTERY PACK NP-6, NP-9

The optional NP-6 and NP-9 Ni-Cd battery will charge in 4 to 6 hours. The LS-202E can be operated even when charging, although charging time will be longer than normal. The CA910E AC charger and CS0912 DC charger are available for the NP-6, and CA-110E and CS-112 for the NP-9 as option.

* When the Ni-Cd batteries have been fully charged, do not attempt to continue charging. The batteries should be charged at temperatures between 0°C and 45°C.

6. CONTROLS AND TERMINALS

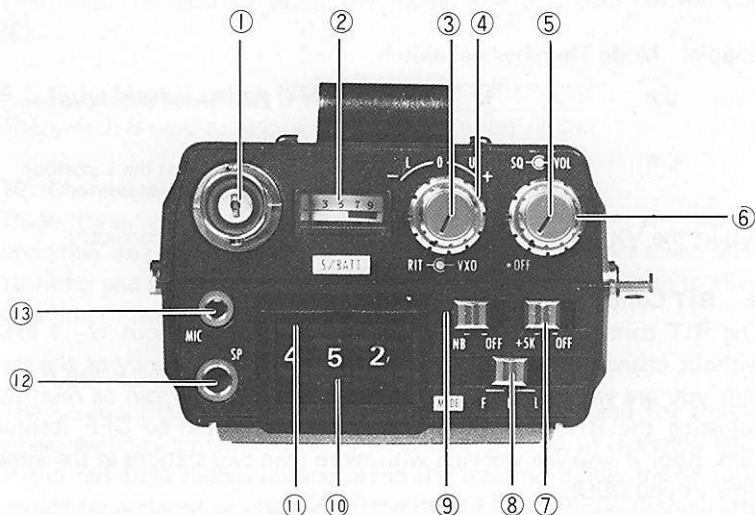

1. Antenna Connector

Connect the supplied rubber-flex antenna or any other 50 ohm antenna system. The optional AN-2 $1/4 \lambda$ rod antenna can also be connected.

2. S/BATT Meter

This meter indicates the strength of receiver input signal (S) and the voltage of the battery in the transmit mode. The pointer comes out of the red zone to indicate the batteries have been worn out.

NEW BATTERY

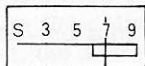

EXHAUSTED BATTERY

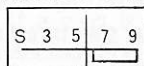

3. VOX Control (SSB only)

The VOX control is used to shift the transmit and receive frequency simultaneously by ± 5 kHz or more to cover the gap between frequencies set by the thumbwheel switches in 5 kHz steps.

Zero beat position varies depending on USB or LSB mode as shown in the diagram.

Exaple: Mode Thumbwheel switch

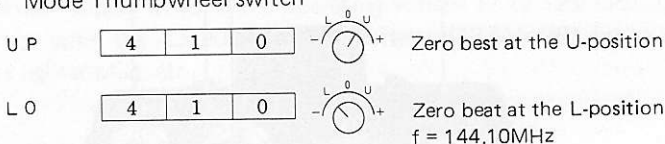

Adjust the VXO control until the receive signal is heard correctly.

4. RIT Control (SSB only)

The RIT control can shift the receive frequency by about ± 1 kHz without changing the transmit frequency. If the frequency of the station you are working changes, your receive frequency can be reset by adjusting the RIT control. The RIT control should be OFF (center click stop) if you are working with more than two stations at the same time (round QSO).

5. Power switch/volume

Turn clockwise to switch the set on, and continue rotating to increase receiver volume. Ensure that the set is switched off when not in use.

6. Squelch control

This adjusts the operating threshold of the squelch system. With the control rotated fully anticlockwise, the squelch is open and noise should be heard from the loudspeaker. To set the squelch, choose a vacant operating frequency, and adjust the squelch control slowly clockwise until the background noise is cut off. This is the most sensitive squelch setting. Further clockwise rotation of the squelch control will raise the threshold of operation, and thus only strong signals will be heard.

7. +5 kHz switch

This switch adds a 5KHz frequency shift to that shown by the thumbwheel switches.

8. Mode switch

This switch is used to select the mode: FM (F), USB (U), or LSB (L).

9. Noise blanker switch (SSB only)

This switch is used to reduce pulse type ignition noise.

10. Channel selector

These three switches are for setting the transceiver to any desired operating frequency within the specifications. The switches select MHz, 100 kHz and 10 kHz steps. A +5 kHz switch is also fitted so as to allow selection of frequency in 5 kHz steps.

11. LED illumination

The green LED illuminates both the S/BATT meter and the thumb-wheel switches simultaneously. In transmit, the red LED should light. If the red LED flashes on and off in the transmit mode, the batteries should be replaced or charged. If the red LED continues flashing after replacing or charging batteries, the set may be faulty. In this case, you should stop operating the set and consult your Belcom dealer at once.

12. External speaker connector (3.5 ϕ plug)

This socket is for connection of external speaker or earphone of 8 ohm impedance. When a plug is inserted into this socket, the internal loud-speaker is disconnected. Decrease receiver volume before inserting the earphone plug into the socket.

13. External microphone connector (2.5 ϕ plug)

This socket is for use with a remote microphone (2 Kohm impedance), such as the optional SH-1 speaker/mic. If a plug is inserted into the socket, the internal microphone is disconnected. For use of any microphone other than the SH-1, refer to the following diagram according to the type of microphone to be used.

- Electret condenser mic
2-pin type

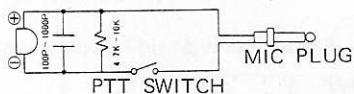

- 3-pin type

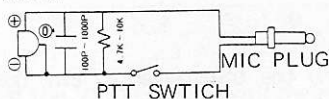

* A condenser (100Pf – 1000Pf) must be wired directly to the microphone unit to prevent RF feedback.

- Dynamic mic

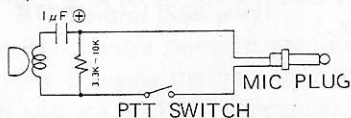

* Use 2 Kohm impedance microphone.

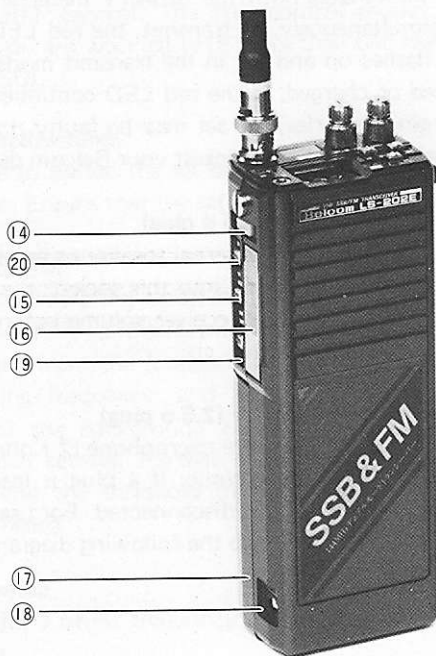

14. Lamp switch

This switch controls the green LED to illuminate the S/BATT meter and the thumbwheel switches on the top panel.

15. Hi/Lo switch

This switch is used to set transmit output power to 2.5 W at "H" position or 0.5 W at "L" position (at 9V). For local contacts, set the output power switch to "L" position so as to reduce battery consumption.

16. PTT switch

Depressing this switch changes the transceiver over from receive to transmit. The red LED indicates transmit mode.

17. Battery case

Refer to page 4 for battery loading and charging.

18. Charger terminal

For charging the NP-6 or NP-9 Ni-Cd battery pack using the CA-910E, CS-912 or CA-110E, CS-112. During charging, the set should be switched off.

Do not connect an external DC supply directly to the charge terminal. Use only the Belcom optional chargers.

19. +/- 600kHz repeater offset switch

This switch allows repeater offset and shifts the transmit frequency either up or down 600kHz from the receive frequency.

20. Tone switch

This switch is used to transmit a TONE burst signal to activate repeater station. The 1750 Hz burst signal is transmitted when the PTT switch is pressed.

7. HOW TO OPERATE

1. Preparations

- 1) Make sure the set is switched off, and load batteries to the battery case observing correct polarity.
- 2) Mount the supplied rubber-flex antenna with the BNC connector.
- 3) Set the squelch control rotated fully anticlockwise.
- 4) Select the desired mode and frequency.

2. Reception

- 1) Turn volume control clockwise to switch on the transceiver.
- 2) Set the squelch control as detailed in page 8.
- 3) In SSB mode, turn the VXO control to search for signals between channels.

3. Transmission

Set the repeater offset switch to simplex position. Press the PTT switch and speak at about 5 – 10 cm from the built-in microphone. The red LED will light.

4. Repeater operation

Set the repeater offset switch to "+" or "-" position as required. With the Tone switch set to ON, press the PTT switch and the repeater station is operated by 1750 Hz tone burst signal.

8. CIRCUIT DESCRIPTION

General

The LS-202E is a compact handportable SSB, FM transceiver covering ranges between 144.000 and 145.995 MHz in 5 KHz steps. It incorporates the latest PLL synthesizer circuits and uses dual gate FET's to ensure high sensitivity and dynamic range.

RECEIVER SECTION

1) Antenna Switching circuit

The signal from the antenna J301 is fed to L101 through the low-pass filter since both D301 and D302 are OFF.

2) RF Amplifier

The signal from L101 is amplified by Q101, and applied to the bandpass filter consisting of L102, L103 and L104.

3) Mixer circuit

The signal is fed to Q102 to be mixed with oscillator frequency from the PLL, and the 1st IF of 10,695 MHz is derived from L105.

4) FM IF Amplifier

The 1st IF of 10.695 MHz is applied to FL101 crystal filter, when CR101 is ON, and amplified by Q103. The signal is then mixed with the PLL standard oscillator frequency of 10.24 MHz at IC101 to convert to the 2nd IF of 455 KHz and applied to FL-103 and FL-104. IC101 consists of limiter amp, quadrature detector, active filter and squelch circuit. The detected AF signal comes out at pin 1.

5) SSB IF Amplifier

The IF frequency of 10.695 MHz from L105 is fed to FL102 crystal filter, when CR102 is ON, and amplified by Q104, Q204 and Q205. The signal from the secondary side of L203 is detected by CR205, 206, 207 and 208 diode.

6) AF Amplifier

The detected AF signal is amplified by IC103 via RV101 audio volume to drive the loudspeaker.

7) Squelch circuit

In FM mode, the squelch is controlled by pin 2 of IC101. The AGC voltage is used to control the squelch in SSB. In both cases, squelch voltage is adjusted by RV202 to control Q105, 106 and 107 AF amplifier IC's.

8) AGC circuit

In the AGC circuit, the signal from L203 is detected by D203 and 204 to reduce the source voltage of Q203 in order to control the gain of Q101 and 204.

9) Meter circuit

In FM, the S-meter is driven by the 2nd IF signal from pin 7 of IC101 via IC102, D105 and 106.

In SSB, the S-meter is driven by the detected output from D205, 206 and 208 via Q206, D211 and 212.

TRANSMITTER SECTION

1) RF Circuit

The VCO frequency and carrier frequency of 10.695 MHz are mixed by L317, L316, D304 and D305, and then amplified by Q304 after filtering through L312, L313 and L314 bandpass filter. The signal is further amplified by Q303, Q302 and Q301 to the specified output power and fed to the antenna through bandpass filter.

2) Microphone Amplifier

In FM, the voice signal from the microphone is amplified by IC405 eliminating frequency higher than 3 KHz, and applied to the VCO circuit for frequency modulation.

In SSB, the voice signal is amplified by Q401 and applied to IC404 balanced modulator together with the 10.695 MHz carrier to generate a DSB signal. The unwanted sideband is removed by FL102., and the resultant SSB signal amplified by Q104, before being mixed with the PLL output frequency in D304 and 305. The output from D304 and 305 is now at final frequency, and is amplified by Q304, 303, 302 and 301 to the 2.5W final level.

3) PTT Circuit

By depressing S404 PTT switch, Q402 activates IC403 to put the transceiver in transmit mode.

PLL SECTION

1) PLL OSC Circuit

The PLL HET. Mixer oscillator is Q509, and crystal Y502 at 32.32625 MHz is doubled to 64.6525 MHz via L520 and L521 before being mixed with VCO output in Q504. The +5 KHz shift circuit is operated when Q506 is turned on so as to shift the frequency upward by 2.5 KHz. The +600 KHz repeater shift is operated when D506 is turned on to obtain 64.9525 MHz from Y506. Q507 provides the +5 KHz shift for the +600 KHz repeater crystal Y504 the -600 KHz repeater shift is operated when D507 is turned on to obtain 64.3525 MHz from Y503. Q508 provides the +5 KHz shift for the -600 KHz repeater crystal Y504.

2) Phase comparison, Master OSC, VCO circuit

The master oscillator frequency of 10.24 MHz is generated by IC502 and is frequency-divided by 1/2048 to produce 5 kHz at pin 6.

This 5 kHz reference signal and the output from IC503 programmable divider are phase-compared by IC501 phase-comparison IC, and the VCO control voltage is obtained at pin 3 of IC501. Q502 VCO oscillator generates 1/2 of VCO oscillator frequency and is tuned by D501 and 502 vari-cap. The desired frequency is obtained when it is locked.

The signal from IC501 pin 4 blocks transmission when the PLL is unlocked.

The VCO frequency is doubled by Q505 after the PLL is locked to the desired frequency.

3) Mixer, Programmable divider

The signal from the VCO is fed to Q503 buffer-amplifier and then mixed with frequency from the VXO oscillator circuit in Q504. The output from Q504 passes through a low pass filter to programmable divider IC503. The programming data for IC503 comes from the thumbwheel switches, and the 5 kHz output fed to comparator IC501.

OTHERS

1) **Carrier Oscillator**

The carrier frequency is generated by Q305. In FM mode, the carrier frequency is 10.695 MHz. In USB mode, Q307 is ON and carrier frequency is 10.6935 MHz. In LSB mode, Q306 is ON and carrier frequency is 10.6965 MHz.

2) **Power Supply**

An IC regulator with low current consumption is employed to enable the transceiver to operate from 7V to 12V. IC401 provides regulated 5.6V to IC402 and IC403 to produce appropriate transmission and receive voltage according to FM and SSB mode.

3) **Tone Circuit**

The 1750 Hz repeater access tone is generated by IC504, which contains a 3.58 MHz crystal oscillator and 1/2048 divider.

9. TROUBLESHOOTING

If the transceiver does not operate correctly, please check the following points:

Symptom	Check
No noise appears	<ul style="list-style-type: none">• Power switch on ?• Squelch control advanced too far• Batteries exhausted or incorrectly loaded
Not operating on required frequency	<ul style="list-style-type: none">• Frequency selector switches incorrectly set• Mode switch incorrectly set
Red LED flashes on and off	<ul style="list-style-type: none">• Batteries exhausted

If you have any queries on the operation of the LS-202E, simply contact the dealer who supplied the unit to you, and they will be pleased to advise.

P.C.B. LAYOUT

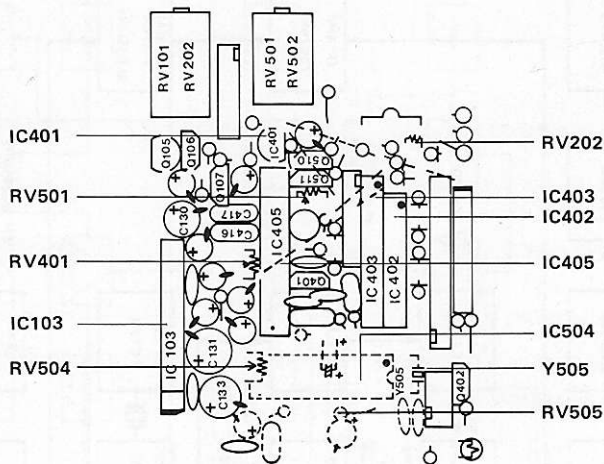

IC103	AF AMP IC
IC401	REGULATOR POWER IC
IC402	POWER SWITCH IC
IC403	POWER SWITCH IC
IC405	FM MIC AMP IC
IC504	TONE IC
Y505	TONE CREAMIC OSC
RV401	FM DEV ADJ
RV202	TX METER ADJ
RV501	FM FREQ ADJ
RV504	TONE DEV ADJ
RV505	TONE TIME ADJ

- 20 -

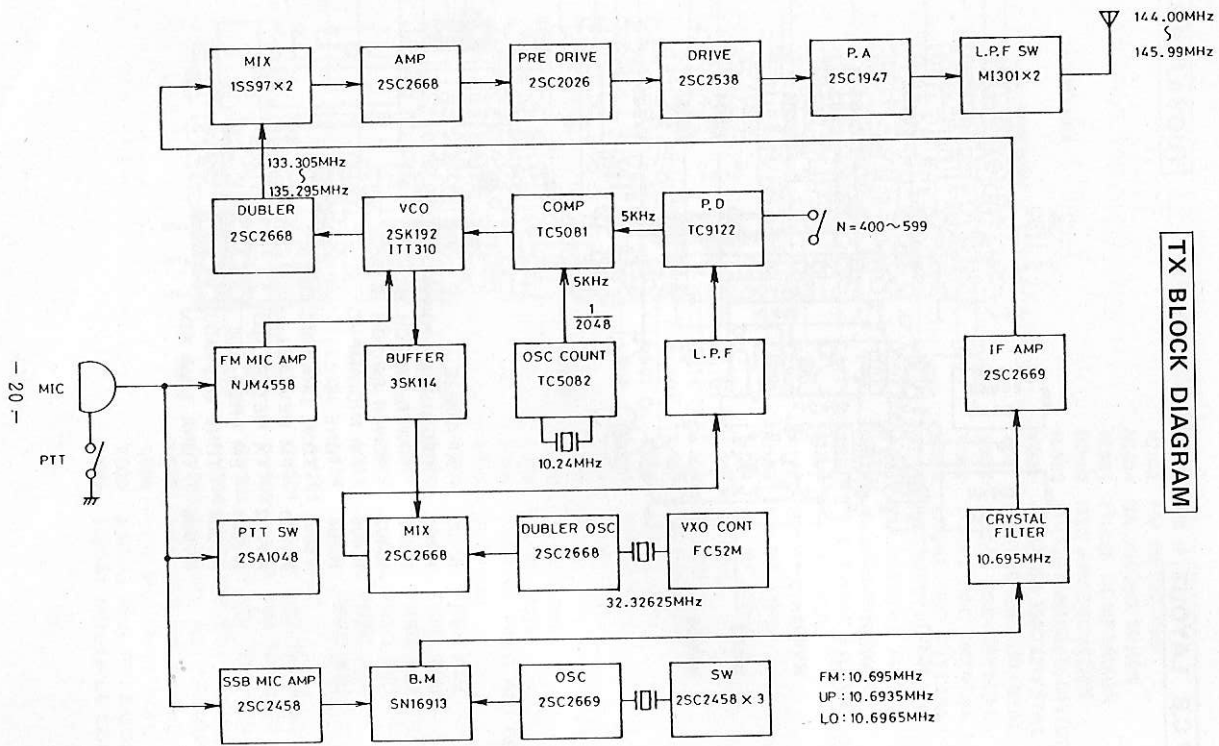

TX BLOCK DIAGRAM

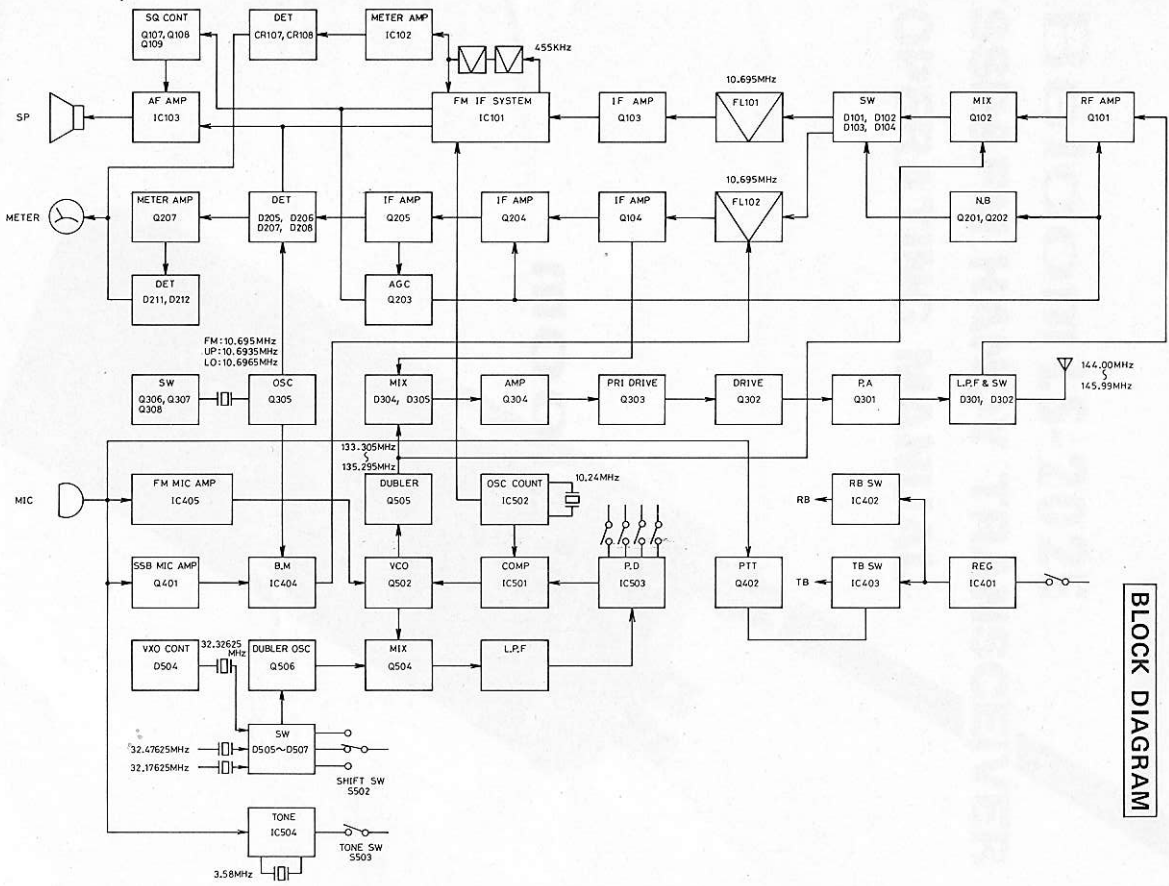

BLOCK DIAGRAM

MARSHALL KITCHEN KIT BLOCK DIAGRAM

Belcom

Printed in Japan

76-479-0