

OPERATING INSTRUCTIONS



STANDARD

C430

430 MHz FM 10W
12CH+MEMORY CH

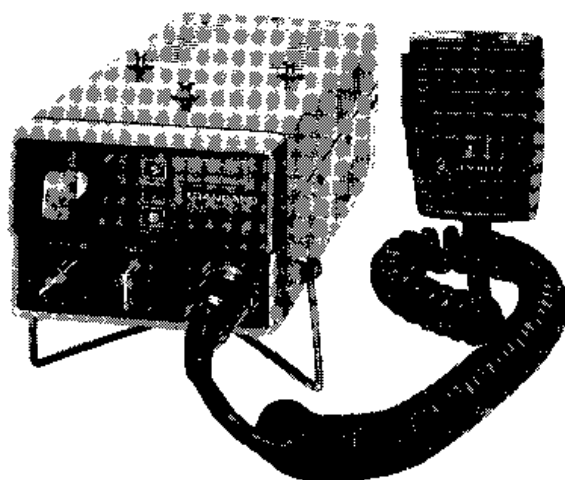

STANDARD RADIO CORP.

3622 Kamitsuruma, Sagami-hara-shi Kanagawa

Phone : 0427-43-1111

Cable : TLX 2872-210 DRADNATS TOKYO

Thank you for your having purchased **STANDARD C 430**, the full solid state FM transceiver for the amateur radio in 430 MHz band. Your unit, composed of the high-gain, high-efficiency transistors, crystal filters, and many other world top quality parts, has been developed by your **STANDARD RADIO CORPORATION** with un-sparing applications of its traditionally held ultra-miniaturization techniques and with its personal considerations given from the standpoint of hams as the actual users. **STANDARD RADIO CORPORATION** proudly presents **C 430** turned out from its modern facilities with its confidence that a number of the product's features and great reliability will provide you with satisfaction.

TABLE OF CONTENTS

1. Features of C 430	2
2. Cautions Prior to Use.....	6
3. Installation Procedures	8
4. Communication Procedures.....	9
5. Memory Channel	10
6. "Busy" Indicator Lamp.....	10
7. Meters	11
8. Calibration Switch	11
9. Squelch Unit	12
10. Stand	12
11. Adjustment of Microphone Sensitivity	13
12. Microphone Connector.....	13
13. Accessory Terminal.....	14
14. Channel Increase	15
15. Accessory Parts.....	17
16. Connection of External Speaker	18
17. Antennas and Coaxial Cables	19
18. Nois Prevention Measures for Use as Mobile Station	20
19. C 430 Specification	21

1. Features of C 430

We know that lighter and smaller high-performance equipment creates new applications, and this quite is true of **C 430**. Such features and many others of this Model as mentioned below will enable all of you—from beginners to veterans—to enjoy a broader scope of the usages:

1. Small Size and Light Weight

This new FM radio, smaller in volume than a half of the comparable products of this Company and as light as 0.96 kg, has succeeded in finding its installation space for mobile station use at vehicle driver's seat area instead of assistant driver's which has been exclusively used for this purpose in the past, and ushered in the debut of a new type mounting metal bracket.

2. Push-In/Pull-Out Metal Bracket

This metal bracket has simplified the attaching and detaching processes of **C 430** on a single motion basis. For attaching, just snap your radio into the bracket. The reverse consequence can be obtained by simply snapping it off toward you. The bracket with the radio off therefrom is an evenly faced sheet metal, which therefore prevents rattling causable during the vehicle operation and also protects your feet against a possible hazard from a sharp projection.

Such attaching and detaching processes do not require you to put in your hands on the sides of the rig. Thus, the attaching process brings the sides of the rig into a close contact with their corresponding parts. The rig's occupancy of small space serves for the efficient employment of the limited interior room of the car.

3. Capacity of 12 Channels Plus 1

C 430 contains a "memory channel" in addition to the regular 12 channels. Place the crystal for a specific frequency in the crystal socket of this memory channel, and a shift to the memory channel will be possible, regardless of the position of the channel selector. The memory channel indicator lamp illuminates in orange color when the rig is operating on the memory channel.

4. Remote-Controlled Switching of Memory Channel

The memory switch conveniently located on the handheld microphone can perform a quick "OFF" and "ON" operation of the memory channel.

5. Calibration Switch

A calibration switch is set on the rear panel of **C 430** for the frequency adjustment and other purposes.

6. Professional-Minded Circuit Design

High-performance silicon transistors and diodes are abundantly used in the circuitry designed professional mindedly. The transmitter is provided with the newest, high-gain, high-efficiency transistors, and the vector composite phase modulation system is adopted for generation of FM wave. The receiver is equipped with the cavity structured radio frequency amplifier and crystal filter.

(a) Receiver

(1) High Sensitivity

High sensitivity design as represented by the -3 dB QS sensitivity at 20 dB and the over 34 dB S/N at 0 dB input.

(2) Radio Frequency Amplifying Stage Having Cavity Structure

The stable operation and high sensitivity help improve the receiving spurious and cross-modulation characteristics.

(3) Crystal Filter

The first intermediate frequency (IF) amplifying stage incorporates a monolithic crystal filter to remarkably enhance the selectivity of the first IF amplifying stage, improve the image of the second IF, and reduce the interference which may be caused at the adjacent frequencies.

Adoption of the crystal filter is aimed not merely at correcting the degradation in the image of the second IF and other deficiencies—regarded as the weak points involving the double superheterodyne system, compared with the single superheterodyne system—but also at taking advantage of the secured high gains which constitute positive point of the double superheterodyne system.

The capabilities of the crystal filter, as reflected in the -70 dB spurious response and the -75 dB sensitivity (at 40 KHz), could be described as more than sufficient.

(4) Ceramic Filter

The ceramic filter in the second IF amplifying stage plays a role for better selectivity characteristics.

(5) Integrated Circuits

The second IF amplifying stage consists of the transistorized 3-stage amplifying unit plus integrated circuitry showing very good limiter effect.

(6) Squelch Circuit

The squelch circuit is a noise rectifier type enjoying an established reputation for mobile station use, and the circuit operates securely, thanks to the high gains resulting from the 2-stage noise amplification.

(7) Squelch Time Constant

With the squelch unit (accessory) connected to the accessory terminal on the rear panel, the squelch time constant can be changed to the best suitable for respective uses as mobile and fixed stations.

(8) 4 W Output at Audio Frequencies

The maximum output at audio frequencies, as much as 4 W, will permit the operation of the transceiver at an adequate sound level while in driving even on extraordinarily noisy express-ways.

(9) "Busy" Indicator Lamp

The green lamp turns off and on in association with the squelch circuit, irrespective of the position of the volume control knob, to clearly indicate which rig is receiving the signal. This lamp is convenient in a parallel operation at 50 MHz, 144 MHz, and other bands.

(10) High Sensitive Incoming Signal Meter

This incoming signal meter, containing a meter amplifier designed to swing the pointer in response even to weak incoming signal, can read in detail the change in the input voltage of the antenna.

(b) Transmitter

(1) High-Gain, High-Efficiency Transistors

Adoption of the newly developed high-gain, high-efficiency transistors—the

Motorola made in the final stage and the TRW made in the driver—has successfully made the protective circuit unnecessary.

(2) High-Efficiency Circuit Design

High-efficiency designed circuit is another feature as proved by the 10 W transmitting output and the 2.5 A power consumption which includes the power consumption for the three lamps and the relay.

(3) Angle Resonator

The band-pass filter constitutes an angle resonator for adequate attenuation of harmonics and other waves.

(4) Twisted Wire

Twisted wire is used for stable impedance convention and wide bandwidth characteristics.

(5) Newly Developed Relay

A new relay suffering an extremely small loss even at UHF band has been developed for adoption as a relay for the antenna and transmitting-receiving power supply switch.

(6) Microphone Gain Control

A semi-fixed resistor for microphone gain control is mounted on the main printed wiring board for transmitter.

(7) Vector Composite Phase Modulation

The vector composite phase modulation system—the orthodoxal modulation system for mobile FM transmitter—is employed.

(8) Instantaneous Deviation Control (IDC) and Speech Roll-off Filter

A combined use of the silicon diode operated IDC and the speech roll-off filter provides high clarity and high average level of modulation, and causes no interference with other channels through expansion of the band occupancy.

(9) Transmitter Indicator Lamp and Meter Facility

When the push button on the microphone is pressed, the red pilot lamp on front panel illuminates to show that the transmitter is in a transmitting mode. During the transmission, the meter on the front panel indicates the relative value of the transmitting output.

7. Channel Selector with Short-Circuiting Ring

The channel selector of **C 430** is provided with a short-circuiting ring to preclude the possible interference caused when additional channel quartz crystals have been installed or when the frequencies of the neighboring channels have been adjusted, thereby helping to make the frequency alignment much easier during the installation of additional channel crystals. The trimmer capacitor for delicate alignment for both the transmitter and receiver can perform accurate adjustment of all the channel frequencies.

8. Crystal Oscillating Unit Designed under the Same Specification as **C 4300**

Master oscillation system is adopted for both the transmitter and receiver, using the frequency ranges available for the most stable oscillation—18 MHz band for transmission and 17 MHz band for receiving. The crystal oscillating unit of **C 430** is interchangeable with that of **C 4300** because of the identical specification.

9. Uncasing Possible with No Help of Tools

Uncasing is possible with the two screws in the rear removed by the fingertip

operation. This feature, together with that of the calibration switch, lends itself to the addition of the channel and other purposes.

10. Anodized Aluminum Chassis

Anodized aluminum is used for both the case and the chassis. The main chassis is 2 mm thick, for an adequate mechanical strength and designed to show good heat sink effect.

11. Green Lighting

Anti-dazzling green lights are employed for both the meter and channel indicators to avoid glaringness otherwise caused during the nocturnal operation of C 430 as a mobile station while in driving, thereby assuring a safer driving.

12. Antenna Connector

The M-shaped antenna connector screws have their pitches available commonly in both inch and millimeter.

13. Microphone Connector with Speaker Terminal

A #4 pin connector is used for microphone connection. The audio frequency output linked to the #4 pin permits the connection to a telephone handset as well as the microphone.

14. Accessory Terminal (A. T.)

A 9 pin accessory terminal is available on the rear for different connections of accessory units from outside.

15. Wide Range of Operating Temperature

The operating temperature widely ranging from -30 degrees C to $+60$ degrees C is good enough for mobile operation even in severely cold environments.

16. Microphone with Memory Switch

The memory switch on the microphone and the micro switch used as a push-to-talk switch help to perform sharp switching from transmission mode to receiving mode and vice versa.

17. Attachable/Detachable Stand

The attachable/detachable stand furnished can facilitate the use of C 430 as a fixed station.

18. Power Supply Protective Circuit

The power supply circuit is provided with a protective function so as to keep the internal circuit from any possible damage caused in wrong connection with reverse polarity of the power supply.

2. Cautions Prior to Use

The following precautions must be observed for the maximum performance of your C 430 and for your enjoyment of better ham life :

1. DO NOT connect or disconnect the power supply cord while keeping the power supply switch at "ON" position.
2. DO NOT connect or disconnect the antenna or external speaker while keeping the power supply switch at "ON" position.
3. DO NOT push the microphone switch with the antenna left disconnected.
4. BE SURE to replace the blown-off fuse with a new one of the designated 3A rating.
5. Prior to the power supply connection, check to see the polarity of the electrical system. C 430 is constructed for negative grounding with the black lead to be grounded.

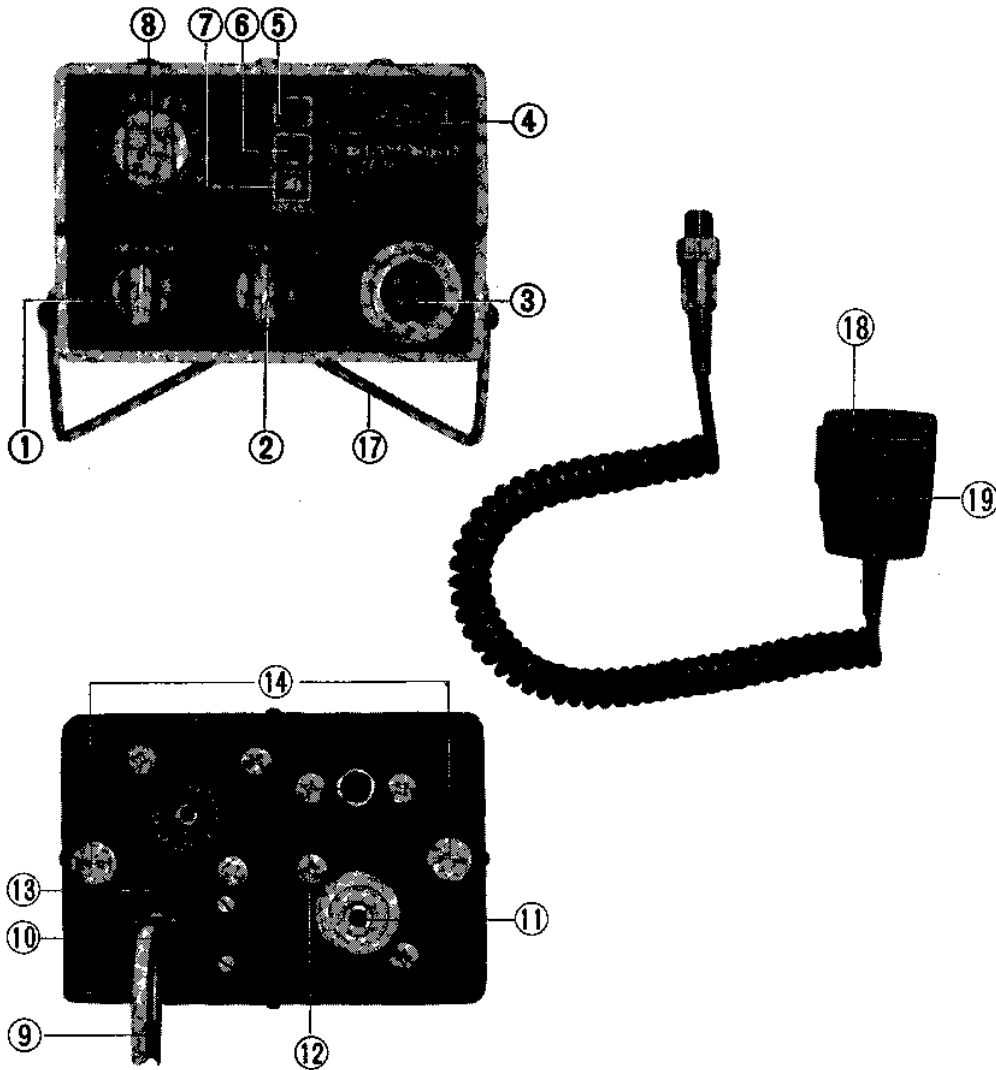

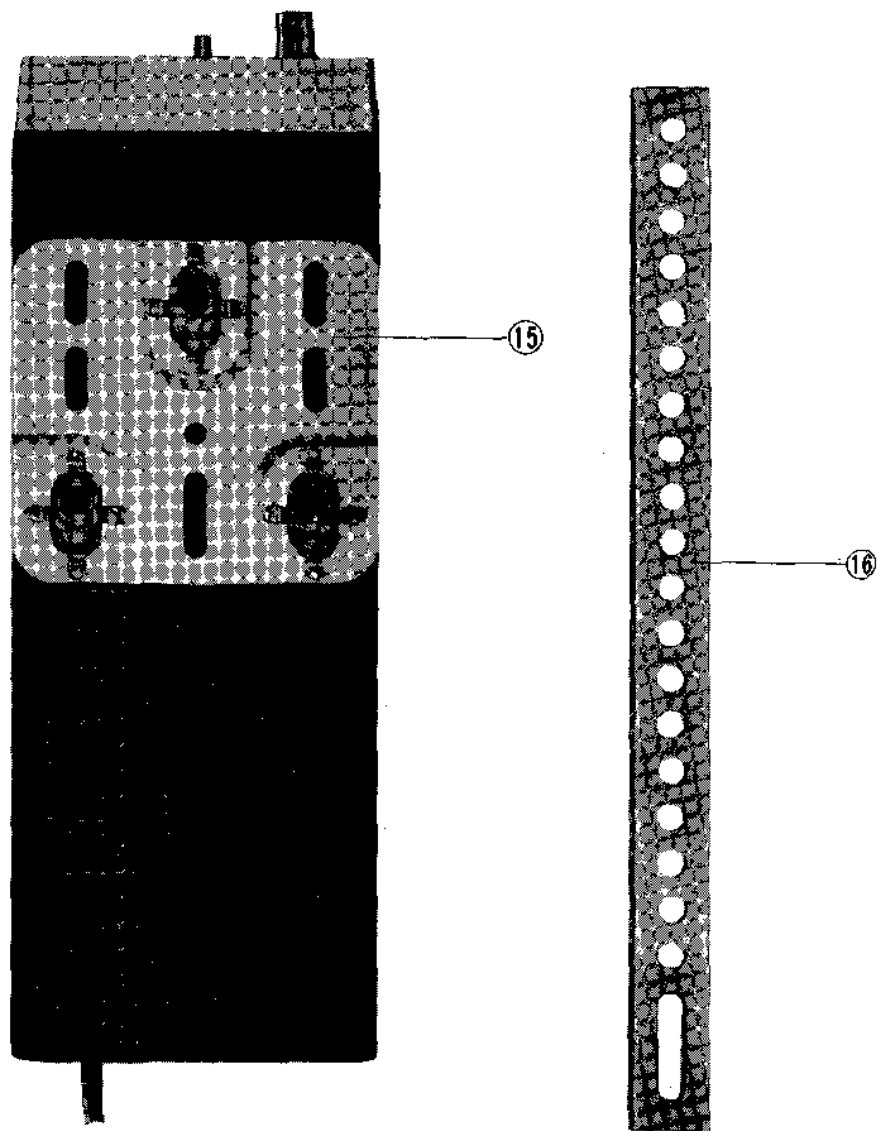

Figure 2-1

①	Volume/On-off switch	⑧	Channel selector	⑮	Mounting bracket
②	Squelch switch knob	⑨	Power cord	⑯	Complemental mounting bracket
③	Microphone connector	⑩	Calibration switch	⑰	Stand
④	Meter	⑪	Antenna connector	⑱	Microphone
⑤	Transmit indicator lamp	⑫	External speaker terminal	⑲	Memory switch
⑥	Busy lamp	⑬	Accessory terminal		
⑦	Memory lamp	⑭	Cabinet fixing screw		

3. Installation Procedures

Determine the installation position with your heed paid to the following points prior to the installation :

1. Is there any unnatural posture required in the operation of the channel selector and other control knobs ?
2. Are all the control knobs and meter scale face located in plain view ?
3. Is the rig's installation position for use as a mobile station not impeding the general motions of the vehicle driver or the operator of C 430 ?
4. Specifically for use as a mobile station, make sure not to place the transceiver anywhere near a heater duct, air conditioner's exhaust mouth, air intake mouth and the like.
5. Refrain from mounting the radio on such places as exposed to rainfall and sea water. Although there is no restriction as to the installation posture of C 430, it is recommended that the body of the radio be set upright for use in yachts, commercial vehicles, etc.

Now, have you decided on the installation position of your radio? If you have take the following installation procedures :

1. Take out the furnished mounting metal bracket ⑮ and attach it at the ensured installation position on the body of the radio. Depending on the installation position, use the supplied auxiliary mounting bracket, which can be bent or cut freely to your need (See Figure 2-1).
2. Position the mounting bracket in predetermined installation place, make a bore for the bracket with a 5 or 5.5 mm drill, and secure it with the supplied screws and nuts, preferably at three or more places. Use wood or tapping screws according to the mounting plane.
3. Set the body of the radio again on the mounting bracket. Prior to taking this step, ensure that the calibration switch on the rear on the body of the radio ⑩ is at "OFF" position (See Figure 2-1).
4. Connect the power supply. At this time, again, make sure of the polarity of the electrical system. Insert the furnished line filter (CLF 03) into the in-line connecting section of the power supply cable.
5. Perfectly connect the antenna connector ⑪ (See Figure 2-1).
6. Connect the microphone to the microphone connector ③ on the front of the radio, and fix the supplied microphone hanger on a convenient place for removal (See Figure 2-1).

The installation is completed. Now, you are ready to start the communication.

4. Communication Procedures

1. Preparation for communication

First, turn the SQL knob ② fully to counterclockwise, and then set the channel selector ⑧ to the channel you desire to use. For use of the memory channel turn on the microphone memory switch ⑭.

2. Turn on the power supply switch

Revolve the VOL. OFF knob ① to clockwise until it clicks and actuates the power supply as indicated by the lighting of the channel selector and meter indication lamps.

3. Adjust the Volume

As you go on rotating the VOL. OFF knob ① to clockwise, you will come to a point where a rustling noise—or the conversation in the case someone is talking over the channel—becomes audible. Set the knob to appropriate volume as you are listening to such noise or conversation over other station.

4. Setting of Squelch Control

Turn the channel selector, and set the SQL knob ②, using a disengaged channel. Revolve the knob slowly to clockwise until you come to a point where a noise suddenly extinguishes. Set the SQL knob on this point, and you will hear no noise but the incoming signal alone through the speaker. In this condition, the signal is of very poor clarity and possibly disturbing even when the squelch circuit turns off and on to the incoming signal. In such case, turn the SQL knob slightly further to the right and set it at an appropriate position.

5. Transmission

Take up the microphone, press the microphone push button, and start talking slowly and distinctively in neither too loud nor too low a voice but at normal vocal level. At this time, the red lamp in the front keeps illuminating to show the transmitting status as long as the push button remains pressed. Simultaneously, the meter indicates the comparative value of the power of transmission. Now, your voice is on the air.

5. Memory Channel

C 430 contains one memory channel in addition to the regular 12 channels. The transmitter and receiver are equipped with the completely independent crystal oscillators for the 12 channels and the memory channel respectively.

The switching process between the 12 channels and the memory channel is accomplished with the bias of the respective oscillators varied by means of the transistor switch. In the actuation of the 12 channels, the oscillation is suspended with the interrupted base bias of the memory channel oscillator, whereas in the actuation of the memory channel, the emitter of the 12 channels oscillator is reversely biased for halt of oscillation. This switching is implemented with the transistor switch operated by the memory switch on the microphone. Therefore, if the memory switch is set at "ON" position, shift to the memory channel takes place, no matter on which position the channel selector is placed. During the operation of the memory channel, the memory indicator lamp on the front panel illuminates in orange color.

WARNING: This Company made microphones without the memory switch (CMP 01, CMP 07, and CMP 08) perform automatic switchover to the memory channel and reject the switchover to the regular 12 channels.

Use either the special channel for your calling channel as the memory channel.

6. "Busy" Indicator Lamp

The green "busy" indicator lamp on the front panel turns off and on under the voltage of the Q 117 emitter varied to the "OFF" and "ON" operation of the squelch circuit. This indicator lamp, which is independent of the audio output, illuminates in green to show that transmitted signal is being received, even if the volume control is turned down, and when in parallel use of the rigs for 50 MHz 144 MHz and others, the green lamp tells from which rig the sound is being received.

7. Meters

Meter ④ indicates the strength of the incoming signal in the receiving process, and the comparative value of power of transmission in the transmitting process. During reception of transmitted signal, the magnitude of the incoming signal to swing the pointer 8 graduations is equivalent to about $5\mu\text{V}$ (14 dB). The indication of the output of the transmitted signal is arranged in about 8 graduations. See Figure 7-1 for the relationship between the incoming signal in reception and the scale of the meter.

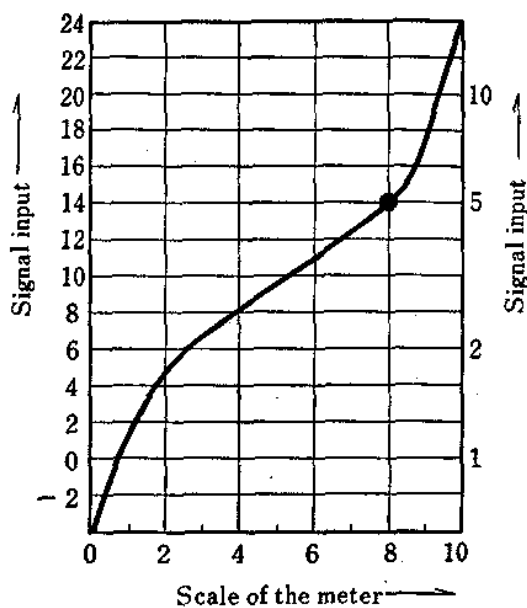

Figure 7-1

8. Calibration Switch

The calibration switch ⑩ on the rear panel, set at "ON" position, sets in simultaneous motion the crystal oscillators, modulators, and the first and second doublers of the receiver and transmitter sections. Use the switch for alignment of the frequencies for reception and transmission of signals with the central meter coupled with #1 and #6 pins of the accessory Terminal.

The calibration switch, which works also as a monitor at the same time, enables you to check on the modulation, etc.

WARNING: DO NOT transmit signal with the calibration switch set at "ON" position.

9. Squelch Unit

The squelch time constant for the body of C 430 is made short for ideal communication between fixed stations. For communication between fixed and mobile stations or between mobile stations, it is recommended that the furnished squelch unit be inserted in the accessory terminal. The squelch unit is designed to allow the connection of a chemical capacitor to #1 and #4 pins of the accessory terminal. #4 pin, connected to the base of the SQL SW Q 115, lengthens the time constant in parallel with C 200. Replace the chemical capacitor of the squelch unit, and change to your desired time constant.

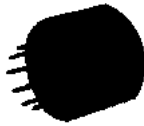

10. Stand

C 430 is provided with the stand ⑰ for use as a fixed station. Insert the stand into the small bores on both sides of the case as shown in the photo.

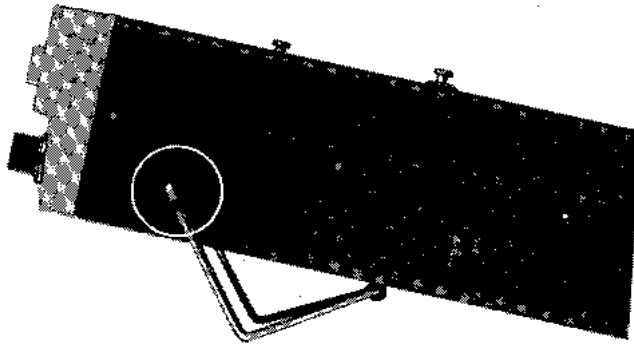

11. Adjustment of Microphone Sensitivity

The microphone sensitivity is adjusted to best meet the purposes of mobile and fixed stations. However, if further adjustment of the sensitivity is necessary, make an adjustment with the semi-fixed resistor of R 331 located on the main printed board for transmitter. See Figure 11-1.

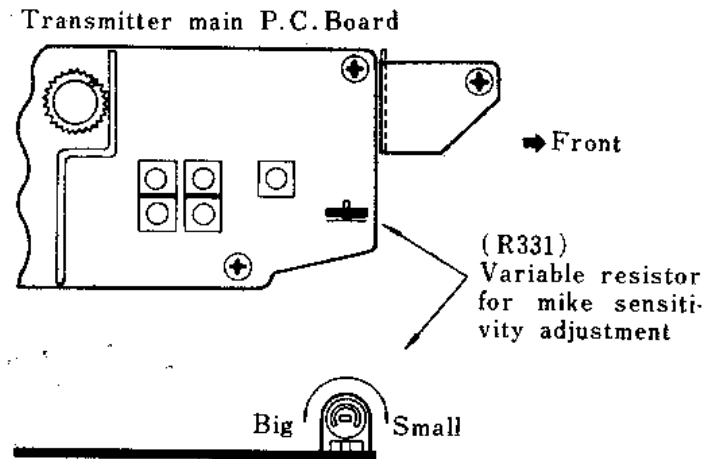

Figure 11-1

12. Microphone Connector

Microphone connection will be made as indicated in the below figure.

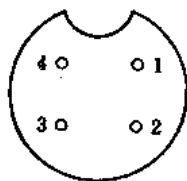
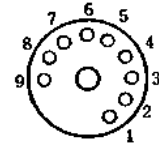

Figure 12-1

- #1. Hot microphone terminal (common with AT-2)
- #2. Grounding terminal (common with AT-1)
- #3. Microphone Push-button switch terminal (common with AT-3)
- #4. Audio output terminal (common with AT-7)

13. Accessory Terminal

The accessory terminal connection will be made as shown in Figure 13-1. You can devise various accessory connections, using this terminal.



AT

Terminal No.	Connection
AT-1	Grounding
AT-2	Microphone input terminal, common with #1 of microphone connector
AT-3	Push-to-talk switch, common with #3 of microphone connector
AT-4	Squelch output, connected to Q 115 base
AT-5	
AT-6	FM detector output
AT-7	Audio frequency output, Auxiliary terminal of external speaker
AT-8	+13.8 V, power supply before power supply switch
AT-9	+13.8 V for receiver

Figure 13-1

14. Channel Increase

1. Specification of Crystal Oscillating Unit

Use the crystal oscillating unit in the size of HC 25/U for both transmitter and receiver.

(a) Crystal Oscillating Unit for Transmitter

The transmitting frequency of C 430 multiplies by 24 times. Therefore, the frequency of the crystal oscillating unit is equal to one 24th of the desired transmitting frequency as indicated by:

$f_{o(T)} = fr/24$, where $f_{o(T)}$ stands for the frequency (in MHz) of crystal oscillating unit for transmitter and fr stands for the desired transmitting frequency (in MHz)

(b) Crystal Oscillating Unit for Receiver

The first local oscillating frequency for C 430 multiplies by 24 times and the first IF is 11.7 MHz. Therefore, the frequency of the crystal oscillating unit for receiver can be calculated by the following formula:

$f_{o(R)} = fr - 11.7/24$, where $f_{o(R)}$ means frequency (in MHz) of the crystal oscillating unit for receiver, and fr represents the desired receiving frequency (in MHz).

No over-tone system is adopted for the crystal oscillating unit for transmitter or receiver. In your order for the crystal oscillating unit, specify the frequency as, for instance, 432.24 MHz for C 430 use.

2. Crystal Oscillator Installation Procedures

When the crystal oscillating unit of your desired frequency is ready, take out the chassis of this transceiver from the case by removing the two case-mounting screws from the rear. For the arrangement of the socket of the crystal oscillating unit, see Figure 14-1.

3. Frequency Adjustment

The frequencies of C 430's actually loaded channels have already been subjected to strict adjustment for both transmitter and receiver.

However, conduct yourself the necessary channel frequency adjustment on any added channels. Absence of the frequency counter makes the frequency adjustment a fairly big job. However, thanks to the C 430's accessory terminal available, you can easily complete the frequency adjustment in the following procedures:

First, connect a 30 to 50 μ A ampere-

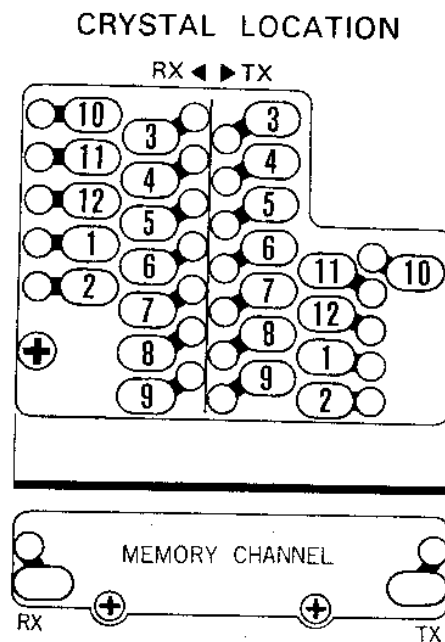

meter to #1 and #6 pins of the accessory terminal, utilizing the tester and other apparatuses, before you are going to take the below mentioned steps.

- (a) Align the receiving frequency of your station with the frequency of another station transmitting with precise frequency.

While in reception of the signal from the station, adjust the trimmer capacitor in the crystal oscillating circuit for receiver so that the connected amperemeter can indicate zero graduation. If you hear any distorted or no sound from the other station even with the amperemeter pointing to zero in the said process, then make a further adjustment on the trimmer capacitor till you get proper adjustment.

- (b) Have Another Station Adjust His Frequency with Yours

With the fine adjusting circuit for transmitting frequency, necessarily provided at the station, have him adjust his transmitting frequency in the same manner.

- (c) Adjust Your Transmitting and Receiving Frequencies

Make adjustment with the calibration switch set at "ON" position.

Simultaneously check on the modulation with the volume control adjusted properly so as not cause any howling. Make sure not to transmit any signal when the calibration switch is set at "ON" position.

The adjustment on the memory channel can be done in the same procedures.

List of Frequencies of Crystal Oscillating Units in Standard Stock for Installation of Additional Channels

For installation of additional channels, the Company has the crystal oscillating units whose frequencies are shown in Figure 14-2 below, constantly maintained as standard stock. This stock will serve for short-time delivery of the units ordered. For the crystal oscillating units for installation of additional channels, which do not come under the standard stock items, consult with this Company's branches or sales representatives.

List of Frequencies of the Units under Standard Stock Items	
431. 04 MHz	432. 24 MHz
431. 16 MHz	432. 36 MHz
431. 28 MHz	432. 48 MHz
431. 40 MHz	432. 60 MHz
431. 52 MHz	432. 72 MHz
431. 64 MHz	432. 84 MHz
431. 76 MHz	432. 96 MHz

Figure 14-2

15. Accessory Parts

The following accessory parts are available for C430 :



① Speaker Box
SR-C 205 K (4 ohms)



③ AC Power Supply
SR-C 12/120-5, 13.8V, 3 A

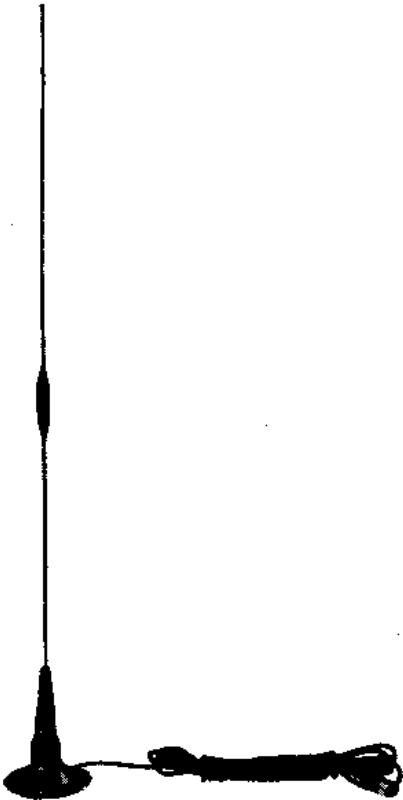

② 5 dB Gain Mobile Antenna
SR-CAT 45

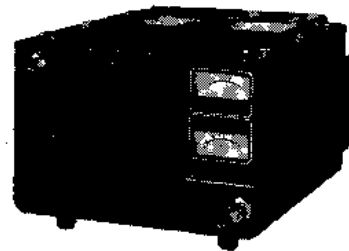

④ AC Power Supply
SR-C 12/120-2, 9 to 16 V, 6.5 A

16. Connection of External Speaker

In the event that the sound volume from the internal speaker is not sufficient, connect external speaker to SPK terminal on the rear panel, and you will find only the external speaker operating with the internal one non-operating.

NOTE: Use an external speaker with 4 to 8 ohm impedance. This Company made speaker box (C 205 K), containing a large oval speaker cone with 4 ohm impedance, will best meet this purpose.

17. Antenna and Coaxial Cables

The quality of the antennas and coaxial cables gives an affect to the performance of C 430. Pay your attention to the following when you buy the antennas and coaxial cables :

Antennas

Use the antenna having a matched impedance of 50 ohms.

Install the antenna at a maximum height possible. Roof top is recommendable for installation of the antenna for mobile station.

Use the antenna with good performance.

Coaxial Cables

Use the coaxial cable having a matched impedance of 50 ohms. Do not use 3C-2V, 5C-2V, etc., because of their matched impedance of 75 ohms.

We recommend as thick coaxial cable as possible for this purpose, because the loss of the coaxial cable in 430 MHz band cannot be disregarded.

In the case of less than 5 m, use RG-58 U, 5 D-2 V, etc.

In the case of 5 m or more, use RG-8 U, 8 D-2 V, 10 D-2 V, etc.

18. Noise Prevention Measure for Use as Mobile Station

Previously, we mentioned the precautions for installation of this transceiver in cars and other transportation. The following measures will be effective for installation in specific types of cars and motor-boats whose engines may produce extraordinarily big noises :

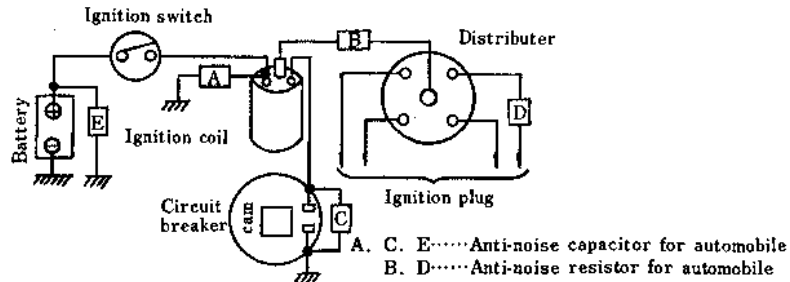

Figure 18-1

The anti-noise capacitors and resistors may be inserted in the places shown as A, B, C, D, and E in Figure 18-1 above. In some cars, the noise can be prevented with such insertion at only one place. In some cases, noise can be decreased if **C 430** is powered by the power supplies of cars, motor-boats, etc. with direct, complete, independent wiring from the power supply of such transportation to that of the transceiver.

19. C-430 Specification

General

1. Application	430 MHz band FM amateur transceiver
2. Number of Channels for Transmitter/Receiver	12 channels plus 1 channel (memory channel)
3. Frequency Range	431.0 to 434.0 MHz
4. Ambient Temperature Range	-30 degrees C to +60 degrees C
5. Microphone	Microphone with Dynamic type memory switch
6. Speaker	6 cm permanent dynamic speaker (8 ohm), internal.
7. Power Supply Voltage	13.8 V DC \pm 20% (negative grounding)
8. Power Consumption	In Transmission: 2.5 A In Reception (Max. Output): 0.6 A In Standby: 0.2 A
9. Semi-Conductor	39 transistors, 23 diodes, and IC
10. Outer Dimensions	84(W) \times 58(H) \times 235(D) (in mm)
11. Weight	0.96 kg.

Transmitter

1. Transmitting Radio Wave	F3
2. Transmitting Output	10 W (at 13.8 V)
3. Output Impedance	50 ohm
4. Maximum Frequency Deviation	\pm 12 KHz
5. Modulation	Vector Composite Phase Modulation
6. Frequency Stability	Less than 0.002%
7. Frequency Multiple	24
8. Modulation Distortion	Less than 6%
9. S/N	45 dB or more

Receiver

1. Receiver Type	Double conversion superheterodyne
2. Intermediate Frequency	First IF-11.7 MHz Second IF-455 KHz
3. First local Oscillating Frequency Multiple	24
4. Frequency Stability	Less than 0.003%
5. Sensivity (20 dB QS)	Less than -3 dB (0 dB= 1μ V)
6. S/N at 0 dB Input	34 dB or more
7. Squelch Threshold Sensitivity	Less than -9 dB
8. Bandwidth	35 KHz or more
9. Selectivity	75 dB or more (in adjustment at 40 KHz)
10. Spurious Response	70 dB or more
11. Allowable Maximum Frequency Deviation	\pm 15 KHz
12. Audio Frequency Output	Internal Speaker (8 ohms)-Max. Output 1.8 W External Speaker (4 ohms)-Max. Output 4 W

20. C 430 Block Diagram

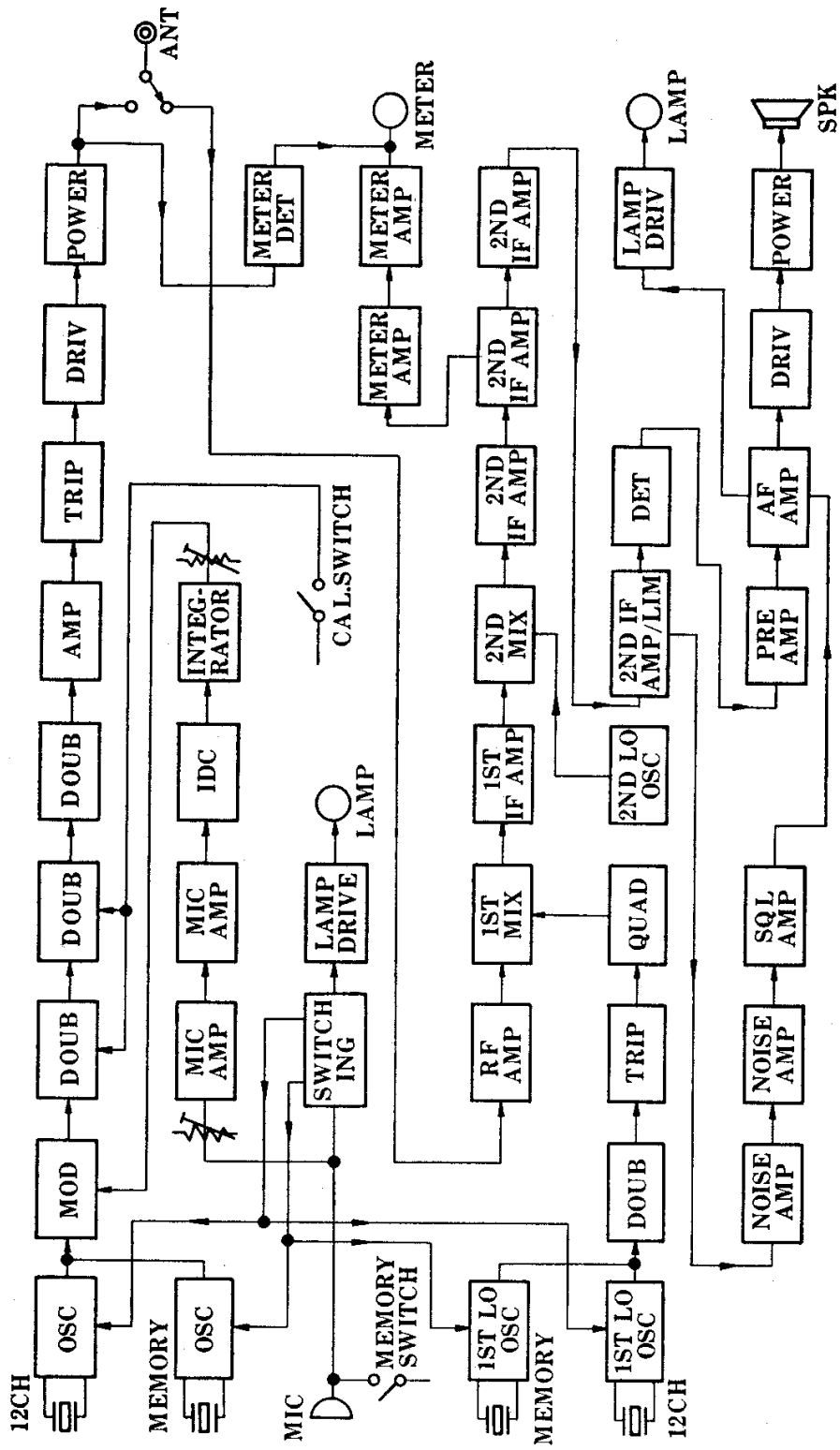

SR - C430

SCHEMATIC DIAGRAM OF TRANSMITTER SECTION

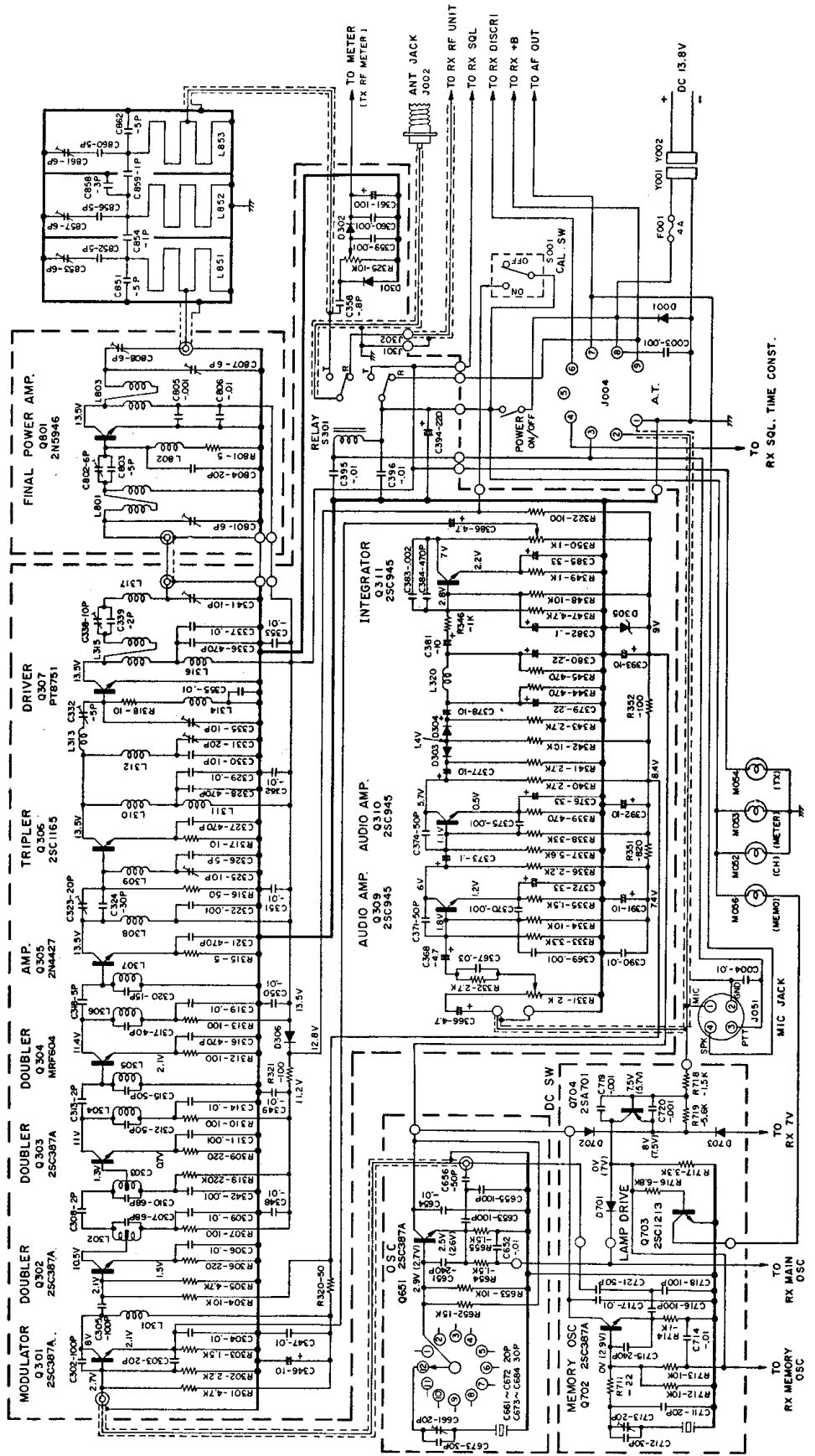

NOTES: UNLESS OTHERWISE SPECIFIED
 RESISTOR VALUES ARE IN OHMS $\pm 10\%$ $1/4W$, $K = 1000$.
 CAPACITOR VALUES ARE IN MICROFARADS, $P = \text{PICOFARADS}$.
 VOLTAGE MARKED AS () : ON SQUELCHED CONDITION.
 VOLTAGE MARKED AS () : ON MEMORY CHANNEL.