

ALINCO

VHF FM HAND HELD TRANSCEIVER

DJ-180

UHF FM HAND HELD TRANSCEIVER

DJ-480

INSTRUCTION MANUAL

ALINCO, INC.

Head Office: "TWIN 21" MID Tower Building 25F
1-61, 2-Chome, Shiromi, Chuo-ku, Osaka 540-8580 Japan
Phone: 06-946-8150 Fax: 06-946-8175 Telex: 63086
E-mail: 101243.1446@compuserve.com
U.S.A.: 438 Amapola Ave., Suite 130, Torrance, CA 90501-6201 U.S.A.
Phone: 310-918-8618 Fax: 310-618-8756
<http://www.alinco.com/>
Germany: Eschborner Landstrasse 55, 60489 Frankfurt am Main, Germany
Phone: 069-786018 Fax: 069-789-60766

This Instruction Manual is for DJ-180 and DJ-480. And the illustration is based on DJ-180.

Printed in Japan
Copyright © 1996 Alinco, Inc. Osaka, Japan

PS0159G

Downloaded by
RadioAmateur.EU

N O T I C E

This equipment has been tested and found to comply with the limits pursuant to Part 15 of the FCC Rules. These limits are designed to provide reasonable protection against harmful interference in a residential installation. This equipment generates, uses, and can radiate radio frequency energy, and if not installed and used in accordance with the instructions, may cause harmful interference to radio communications. However, there is no guarantee that interference will not occur in a particular installation. If this equipment does cause harmful interference to radio or television reception, which can be determined by turning the equipment off and on, the user is encouraged to try to correct the interference by one or more of the following measures.

- *Reorient or relocate the receiving antenna.*
- *Increase the separation between the equipment and receiver.*
- *Connect the equipment into an outlet on a circuit different from that which the receiver is connected.*
- *Consult the dealer or an experienced radio/TV technician for help.*

TABLE OF CONTENTS

INTRODUCTION	3
1. ACCESSORIES	4
2. SPECIFICATIONS	
2-1 GENERAL	5
2-2 TRANSMITTER	5
2-3 RECEIVER	6
3. CONTROL FUNCTIONS	
3-1 CONTROLS	7
3-2 LCD PANEL	10
4. OPERATION	
4-1 RECEIVING	12
4-2 TRANSMITTING	12
4-3 FREQUENCY SELECTION	12
4-4 SETTING THE CHANNEL STEP	13
4-5 THE OFFSET FREQUENCY	14
4-6 TONE ENCODER AND TONE SQUELCH	15
4-7 MEMORY CHANNEL	16
4-8 CALL CHANNEL	17
4-9 SCANNING	18
4-10 TRANSMITTER POWER OUTPUT SELECTION	19
4-11 KEY LOCK/ PTT KEY LOCK	20
4-12 TONE BURST(E, EA, EB VERSIONS ONLY)	20
4-13 AUTOMATIC POWER OFF	21
4-14 LAMP	21
4-15 SQUELCH OFF	21
4-16 ON/OFF OF BEEPER	21
4-17 RESET	22
5. Ni-Cd BATTERY PACK	24
6. CHARGER	25
7. INSTALLING OPTIONAL UNITS	25

INTRODUCTION

Thank you for purchasing the "ALINCO" transceiver.

ALINCO radios and other products are ranked as some of the finest in the world. Your transceiver has been manufactured and tested very carefully at the factory and will give you satisfactory operation for many years. We are confident that you will be very satisfied with your choice of this fine ALINCO radio.

1. ACCESSORIES

ACCESSORIES

•Ni-Cd Battery Pack 7.2V 700mAH.....	EBP-26N
•Ni-Cd Battery Pack 12V 700mAH	EBP-28N
•Ni-Cd Long Life Battery Pack 7.2V 1200mAH	EBP-24N
•Dry Cell Case (1.5V x 6pcs.)	EDH-11
•AC Wall Charger	EDC-49 (for 117V)
•AC Wall Charger	EDC-50 (for 220/240V)
•Mobile Bracket	EBC-6
•AC Quick Charger	EDC-45 (for 117V AC)
•AC Quick Charger	EDC-46 (for 220V/240V AC)
•Headset (inner)	EME-13
•Headset (ear hook)	EME-12
•Speaker Microphone	EMS-9
•Soft Case	ESC-18
•Soft Case	ESC-19
•Tie-Pin Microphone	EME-15
•Tone Squelch Unit	EJ-17U
•DTMF Encoder Unit with Key Pad	EJ-13U
•50ch Memory Unit	EJ-14U
•200ch Memory Unit	EJ-15U
•DC IN Unit	EDH-12

2. SPECIFICATIONS

2-1 GENERAL

Frequency Coverage :	RX : 137.000~173.995MHz (T, TM version) TX : 144.000~147.995MHz (T, TM version) RX : 137.000~173.995MHz (TA, TB, TA2, TB2 version) TX : 137.000~173.995MHz (TA, TB, TA2, TB2 version) RX / TX : 144.000~145.995MHz (TS, TSA, TZ, E, EA, EB version) RX / TX : 440.000~449.995 MHz (DJ-480T only) RX / TX : 430.000~439.995 MHz (DJ-480E only) RX / TX : 400.000~519.995 MHz (DJ-480C, TA version)
Frequency Resolution :	5, 10, 12.5, 15, 20, 25kHz steps
Memory Channels :	10 Channels (standard)
Antenna Impedance :	50 Ω unbalanced
Modulation :	F3E (FM)
Power Supply Requirement :	5.5V~13.8V DC (Rated 7.2V Ni-Cd)
Dimensions :	Approximately 132(H) × 58(W) × 33(D) mm
Weight :	Approximately 350g

2-2 TRANSMITTER

Output Power :	About 5.0Watts with Optional 12V Ni-Cd Battery About 2.0Watts with Standard 7.2V Ni-Cd Battery (144.000~147.995 MHz) (160.000~165.000 MHz) ... TA2, TB2 only (440.000~449.995 MHz) ... DJ-480T only (430.000~439.995 MHz) ... DJ-480E only (400.000 ~ 420.000 MHz) ... DJ-480C1, TA1 only (450.000 ~ 470.000 MHz) ... DJ-480C2, TA2 only (430.000 ~ 450.000 MHz) ... DJ-480C3, TA3 only (470.000 ~ 490.000 MHz) ... DJ-480C4, TA4 only (490.000 ~ 510.000 MHz) ... DJ-480 TA5 only
Modulation System :	Variable Reactance Frequency Modulation
Max. Frequency Deviation :	+ / - 5kHz
Tone Frequency :	67.0 to 250.3Hz 38 Subaudible Encoding Tones (E, EA, EB version option)
DTMF Encoder :	(TZ, EB version option)
Tone Burst :	(E, EA, EB version only)

Downloaded by
RadioAmateur.EU

2-3 RECEIVER

Receiver System :	Double-Conversion Superheterodyne
Intermediate Frequency :	1st IF : 21.4 MHz (30.85 MHz ... DJ-480 only) 2nd IF : 455 kHz
Sensitivity :	12 dB SINAD less than $-16 \text{ dB}\mu$ (144.000~147.995 MHz) (160.000~165.000 MHz) ... TA2, TB2 only (440.000~449.995 MHz) ... DJ-480T only (430.000~439.995 MHz) ... DJ-480E only (400.000~420.000 MHz) ... DJ-480C1, TA1 only (450.000~470.000 MHz) ... DJ-480C2, TA2 only (430.000~450.000 MHz) ... DJ-480C3, TA3 only (470.000~490.000 MHz) ... DJ-480C4, TA4 only (490.000~510.000 MHz) ... DJ-480 TA5 only

Downloaded by
RadioAmateur.EU

3. CONTROL FUNCTIONS

3-1 CONTROLS

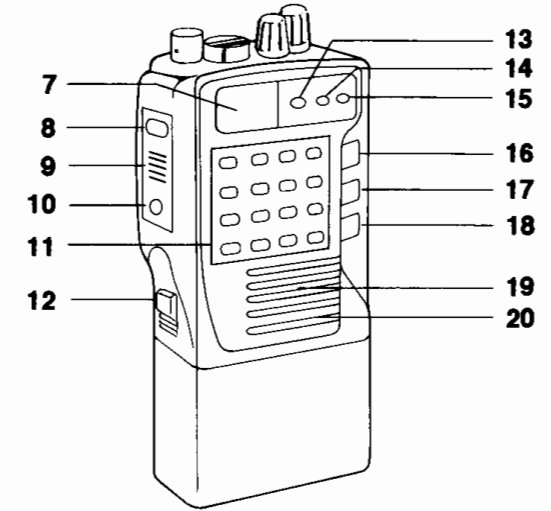
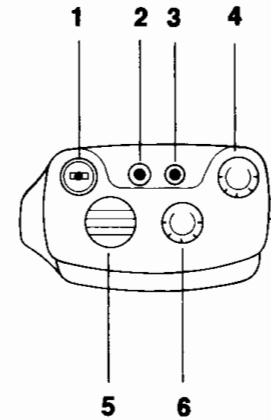

1 BNC Antenna Connector

Attach the included rubber ducky antenna, or an external antenna to this connector.

2 Speaker Jack

This jack is for an external speaker. ALINCO's optional accessories are recommended.

3 MIC Jack

This jack is for an external microphone. ALINCO's optional accessories are recommended.

4 Dial

This dial is used to change the frequency by channel step in VFO mode. It can also be used to change the memory channel number in the Memory mode.

5 Squelch Control

When no signal is present in the receive mode, adjust squelch control clockwise until background noise just disappears.

6 ON/OFF Volume Control

In the full counterclockwise position, power is OFF. Rotate clockwise to turn on and increase the audio.

7 LCD

The display shows the status of each function.

8 Function (F) Key

This key is used to access all secondary functions (printed in blue).

9 PTT (Press To Talk) Key

Press this button for transmission and speak into the microphone.

10 Tone Burst Key

On the DJ-180E this button transmits a Tone Burst. On the DJ-180T this button activates PTT.



11 DTMF Key Pad

Press the key pad during transmission, DTMF tones will be transmitted.

12 Battery Release Button

This button is used to release the battery pack from the radio. To release, slide up and hold the release button and then slide the battery pack to the left side.

13 V/M, OFFSET Key

- (1) This key switches the mode between VFO and Memory. Press the  Key. "M" will appear on the LCD in the Memory mode. When "M" does not appear, the unit is in the VFO mode.
- (2) Press and hold the (F) key, then press the  key to select the "OFFSET" mode.

14 SCAN/STEP Key

- (1) Press this key to start the SCAN function.
- (2) Press and hold the (F) key, then press the  key to select a Channel step.

15 CALL, APO Key

- (1) Press this key to put the radio in the Call Channel mode.
- (2) Press and hold the (F) key, then press the  key to set the Auto Power Off function.

16 LAMP, KL.PL Key

- (1) Press this key and the light behind the LCD will be lit for 5 seconds.
- (2) Press and hold the (F) key, then press the  key. The LCD shows as follows:
 - When the "KL.PL" key is pressed once, "KL" will appear.
 - When the "KL.PL" key is pressed twice, "PL" will appear.
 - When the "KL.PL" key is pressed three times, both "KL" and "PL" will appear.

17 MONI, H/L Key

- (1) Press this key to disengage the squelch. Release the key to reengage the squelch.
- (2) Press and hold the (F) key, then press the  key to change the transmission power.

18 TONE, MW Key

- (1) When the Tone Squelch Unit is equipped, the tone squelch function is available. (standard on U.S. model)
- (2) In the VFO mode, press and hold the (F) key, then press the  key to write a frequency and other data into the Memory Channel.

19 Speaker

A speaker is built-in.

20 Microphone

An electret condenser microphone is built-in.

3-2 LCD PANEL

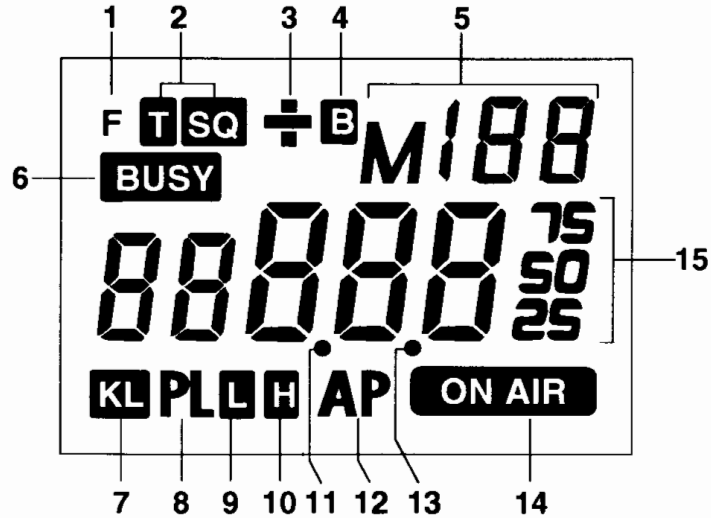

1 F (FUNCTION)

The "F" symbol will appear on the LCD while the (F) key is pressed.

2 T.SQ (Tone Squelch)

"T" will appear on the LCD in the Tone Encoder Setting mode, and "T SQ" will appear in the Tone Squelch mode.

3 +/- (Transmit Shift)

To select the automatic transmitter offset shift, press and hold the (F) key, then press the ^{V/M} _{OFF SET} key, the LCD shows as follows:

- (1) When the "OFFSET" key is pressed once, "-" (minus) will appear.
- (2) When the "OFFSET" key is pressed twice, "+" (plus) will appear.
- (3) When the "OFFSET" key is pressed three times, the display will return to the frequency.

4 Battery Low

"B" will appear when the batteries should be replaced or charged.

5 Memory Number

The Memory Channel Number will appear.

6 Busy

"BUSY" will appear when the squelch is disengaged.

7 KL

"KL" will appear when the Key Lock Function is activated.

8 PL

"PL" will appear when the PTT Key Lock function is activated.

9 Low Power

"L" will appear when Low power is active.

10 High Power

"H" will appear when High power is active.

11 Frequency Decimal Point

When receive, transmit or offset frequency is displayed on the LCD, the decimal point divides MHz and 100KHz. The decimal point will flash when the unit is in the SCAN mode.

12 AP

"AP" will appear when Auto Power Off is activated.

13 Tone Frequency Decimal Point

When a Tone frequency is displayed, the decimal point divides Hz and 0.1 Hz.

14 ON AIR

"ON AIR" will appear while transmitting.

15 Frequency Indicator

Receive and transmit frequencies, offset and tone frequencies and channel step are displayed in this area depending on the selected mode.

4. OPERATION

4-1 RECEIVING

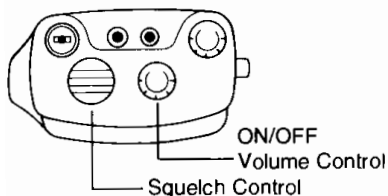

1. Rotate the "ON/OFF Volume Control" clockwise to turn on the power.
To increase the audio, rotate the knob clockwise and adjust the volume to the desired level.
2. Rotate the "Squelch Control" clockwise slowly until the white noise is off.
3. Select the desired frequency.
See "4-3 FREQUENCY SELECTION".
When a signal is received on the selected frequency, " **BUSY** " will appear on the LCD, and the voice will be heard.

4-2 TRANSMITTING

1. Select the desired frequency. See "4-3 FREQUENCY SELECTION".
 2. Press the "PTT" key and the unit starts transmitting. Talk normally into the microphone, which is built in the front case, while pressing the "PTT" key.
 3. Release the "PTT" key to resume a receiving mode.
- Note:**
If the "PTT" key is pressed outside the TX frequency range, "OFF" will appear on the LCD and you can not transmit.

4-3 FREQUENCY SELECTION

Make sure that there is no indication of "M" or "C" on the LCD in the VFO mode.

The VFO mode can be accessed using the  key.



Channel Step

1. Rotate the tuning dial clockwise: the frequency is increased one channel step for each click.
2. Rotate the tuning dial counterclockwise: the frequency is decreased one channel step for each click.

1MHz Step

When the  key is pressed and held, the frequency is increased or decreased by 1MHz depending on the direction of tuning dial rotation.

4-4 SETTING THE CHANNEL STEP

1. Press and hold the  key, then press the  key.
2. Rotate the dial clockwise or counterclockwise to change the Channel Step as shown at left. Choose the desired step.
3. Press the  key. The LCD goes back to the indication of the frequency.

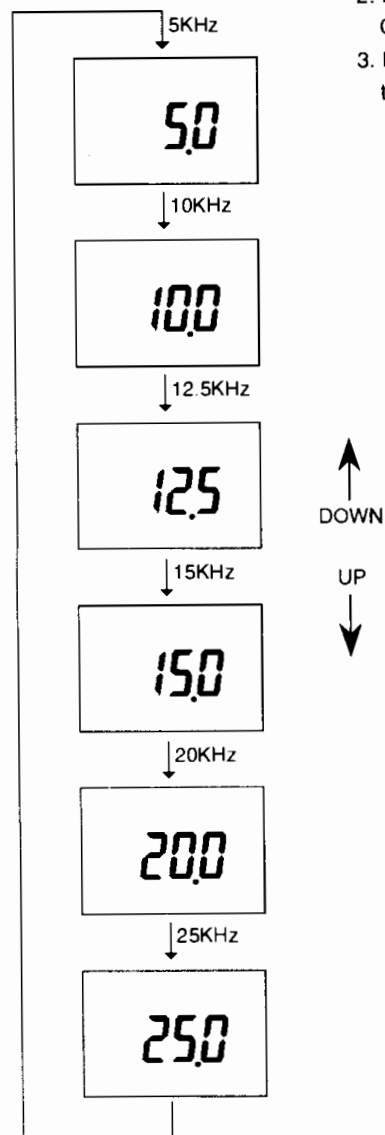

4-5 THE OFFSET FREQUENCY

Almost all repeaters operate in the duplex mode. They receive on one frequency and transmit on another frequency. The difference between these frequencies is the offset, or shift frequency. The range of this frequency is 0~15.995MHz.

(1) Setting the Offset Frequency

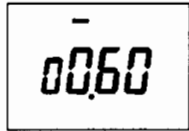

1. Press and hold the **(F)** key, then press the **V/M OFF SET** key. The offset frequency will appear on the LCD.
2. Rotate the tuning dial clockwise: the frequency is increased one channel step for each click.
3. Rotate the tuning dial counterclockwise: the frequency is decreased one channel step for each click.
4. When the **(F)** key is pressed and held, the frequency is increased or decreased by 1MHz depending on the direction of tuning dial rotation.
5. Press and hold the **(F)** key, then press the **V/M OFF SET** key. The offset direction will be changed as indicated on left.

(2) Setting the Offset Direction

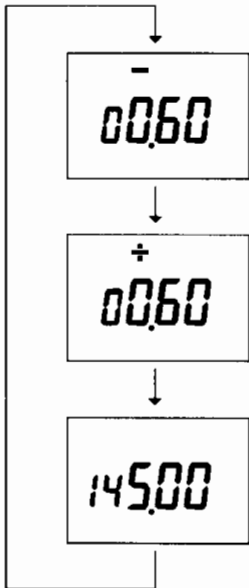

6. Press the **V/M OFF SET** key. The LCD goes back to the indication of the frequency.

4-6 TONE ENCODER AND TONE SQUELCH

This feature is available when the optional tone squelch unit is equipped.

(1) Setting the Tone Frequency



1. Press the **(TONE MW)** key. The tone frequency will appear on the LCD.
2. Rotating the dial clockwise increases the frequency and rotating the dial counterclockwise decreases the frequency. One of 38 standard tones (listed below) can be selected.

67.0	71.9	74.4	77.0	79.7	82.5
85.4	88.5	91.5	94.8	97.4	100.0
103.5	107.2	110.9	114.8	118.8	123.0
127.3	131.8	136.5	141.3	146.2	151.4
156.7	162.2	167.9	173.8	179.9	186.2
192.8	203.5	210.7	218.1	225.7	233.6
241.8	250.3				

Table 1. Tone Frequencies

(2) Setting the Tone Encoder/Tone Squelch

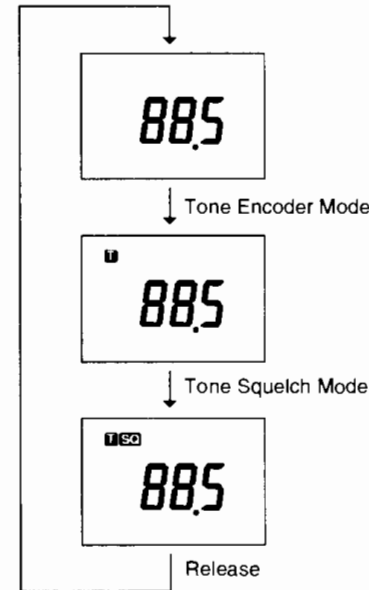

3. After the tone is selected, "T" or "TSQ" can be selected by repeated pushing of the **(TONE MW)** button, as shown below.

4. Press the **V/M OFF SET** key. The LCD goes back to the indication of the frequency.

4-7 MEMORY CHANNEL

This transceiver has 10 memory channels (0-9 standard). Two kinds of memory units are available as options. One optional memory unit has 50 memory channels (0-49), and the other has 200 memory channels (0-199).

(1) Accessing the Memory Channel

Flashing "M"



VFO Data

Steady "M"

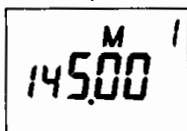

Memory Data

1. Press the $\begin{matrix} \text{V/M} \\ \text{OFF} \\ \text{SET} \end{matrix}$ key.
"M" appears on the LCD, and the unit goes into the Memory mode.
The flashing "M" means that the memory channel is not used, and the VFO data appears on the LCD.
The steady "M" means that the data has been stored in the memory channel.
2. Rotate the tuning dial clockwise, and the memory channel number is increased one channel step for each click.
3. Rotate the tuning dial counterclockwise, and the memory channel number is decreased one channel step for each click.
4. When the optional memory unit is installed, while holding the (F) key, rotate the tuning dial, and the memory channel number is increased or decreased by 10 channels depending on the direction of tuning dial rotation.

(2) Storing a Frequency in a Memory Channel

1. Press the $\begin{matrix} \text{V/M} \\ \text{OFF} \\ \text{SET} \end{matrix}$ key to select the memory mode.
2. Using the tuning dial, select a desired memory channel number.
3. Press the $\begin{matrix} \text{V/M} \\ \text{OFF} \\ \text{SET} \end{matrix}$ key to go back to the VFO mode.
4. Select the desired frequency. Set the offset and tone functions, if necessary.
5. Press and hold the (F) key, then press the $\begin{matrix} \text{TONE} \\ \text{MW} \end{matrix}$ key. A beep sound will be heard. The VFO frequency is now stored in the selected memory channel.

(3) Erasing a Memory Channel

1. Press the $\begin{matrix} \text{V/M} \\ \text{OFF} \\ \text{SET} \end{matrix}$ key to select the memory mode.
2. Using the tuning dial, select a desired memory channel number.
3. Press and hold the (F) key, then press the $\begin{matrix} \text{TONE} \\ \text{MW} \end{matrix}$ key. A beep will be heard. The stored frequency is now erased. Flashing "M" and VFO data will appear on the LCD.

(4) What can be stored in Memory

1. Frequency
2. Offset Frequency
3. Shift Direction +/-
4. Tone Frequency (option)
5. Tone Encoder/Tone Squelch Selection (option)

4-8 CALL CHANNEL

The initial factory call channel setting is 145.00MHz.

(1) Accessing the Call Channel

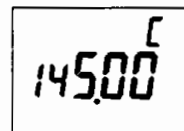

1. Press the $\begin{matrix} \text{CALL} \\ \text{APO} \end{matrix}$ key. The call channel is accessed and "C" will appear on the LCD.
In the call mode, the frequency and memory number can not be changed by using the dial.
2. Press the $\begin{matrix} \text{CALL} \\ \text{APO} \end{matrix}$ key again to return to the VFO or memory mode.

(2) Changing the Frequency in the Call Channel

The memory channel "0" is assigned to the call channel. Any information stored in memory channel "0" can be instantly accessed with the $\begin{matrix} \text{CALL} \\ \text{APO} \end{matrix}$ button. See "4-7 MEMORY CHANNEL (2) Storing a Frequency in a Memory Channel".

(3) Erasing the Frequency of the Call Channel

When the data of the memory channel "0" are erased, the call channel can not be accessed even if you push the call key. See "4-7 MEMORY CHANNEL (3) Erasing a Memory Channel".

4-9 SCANNING

(1) VFO Scan

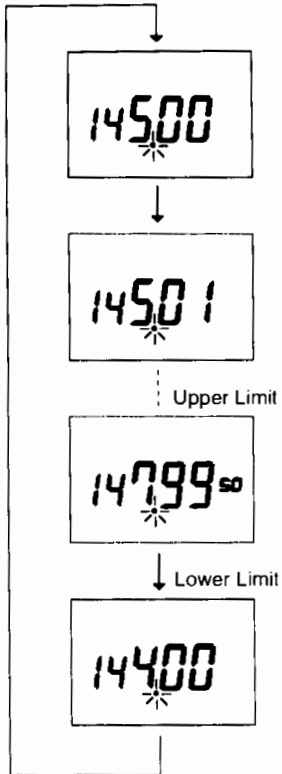

1. Press the **V/M OFF SET** key to select the VFO mode.
2. Press the **SCAN O STEP** key.
The frequency decimal point flashes indicating that the scanning starts.
3. Rotate the tuning dial clockwise to start upward scan, or counterclockwise to start downward scan by one channel step. The scan will proceed over the entire tuning range of the radio.
4. Press the **SCAN O STEP** key again to stop scanning.

(2) Memory Scan

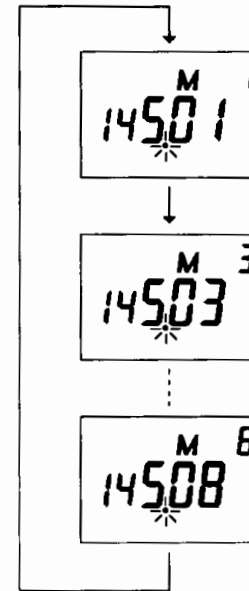

1. Press the **V/M OFF SET** key to select the memory mode.
2. Press the **SCAN O STEP** key.
The frequency decimal point flashes indicating that the radio is scanning.
3. Rotate the tuning dial clockwise to start upward scan, or counterclockwise to start downward scan. The radio will only scan memory channels in which data has been stored.
4. Press the **SCAN O STEP** key again to stop scanning.

Scanning stops at busy channel or frequency, then resumes 5 seconds later even if the channel remains busy. Scanning will also resume when a received signal ceases.

4-10 TRANSMITTER POWER OUTPUT SELECTION

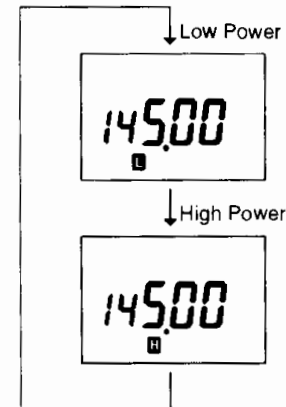

Press and hold the **(F)** key, then press the **(MONI/HIL)** key. The transmitter power output will be changed as shown at left.

4-11 KEY LOCK/PTT KEY LOCK

Press and hold the (F) key, then press the  key. The setting will be changed as shown at left.

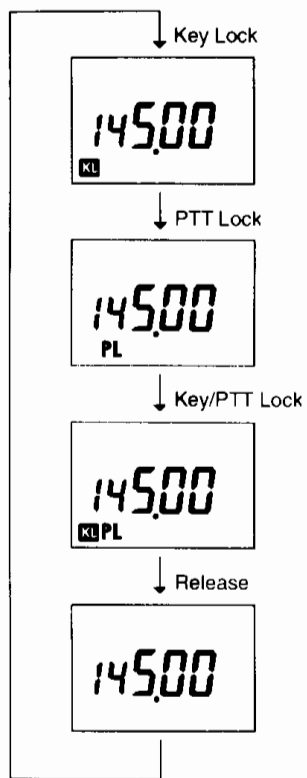

In Key Lock Mode; "LAMP", "MONI", "PTT", and "TONE BURST" keys are acceptable.

In PTT Lock Mode; the radio will not transmit even if the "PTT" or "TONE BURST" key is pressed.

4-12 TONE BURST (E, EA, EB VERSIONS ONLY)

While pressing the "TONE BURST" key located under the "PTT" key, 1750Hz tone will be transmitted. This feature is necessary for many European repeaters.

4-13 AUTOMATIC POWER OFF

The APO function prevents inadvertent waste of battery power when the radio is left ON unintentionally.

(1) To activate



Press and hold the (F) key, then press the  key. "AP" will appear on the LCD.

To cancel APO, press and hold the (F) key, then press the  key.

(2) Automatic Power Off Operation

After about thirty minutes of no activity, a beep is heard and the LCD disappears. The radio is now turned off. To turn the radio on again, turn off the power switch then turn on the power again.

Note: Any signal that breaks squelch will reset the APO timer.

4-14 LAMP

Press the  key to illuminate the LCD.

The lamp goes out automatically after five seconds of no activity. LAMP may also be canceled by pressing the  key again.

4-15 SQUELCH OFF

Press and hold the  key to override squelch. In this mode weak signals below the squelch threshold may be heard.

4-16 ON/OFF OF BEEPER

Press and hold the  key, then turn on the radio. The beep will not be heard.

Press and hold the  key, then turn on the radio again to hear the beep sound.

4-17 RESET

Press and hold the **(F)** key, then turn on the radio. The radio will be reset to the initial factory settings as follows:

VFO Frequency	145.00MHz
CALL Frequency (Memory Channel 0)	145.00MHz
Memory Channel 1~9	Nothing
Shift Direction	Simplex
Offset Frequency	0.6MHz
Tone Setting	Nothing
Tone Frequency	88.5Hz
Channel Step	5 kHz

DJ-480T, TA only

VFO Frequency	445.00MHz
CALL Frequency (Memory Channel 0)	445.00MHz
Memory Channel 1~9	Nothing
Shift Direction	Simplex
Offset Frequency	5.0MHz
Tone Setting	Nothing
Tone Frequency	88.5Hz
Channel Step	5 kHz

DJ-480E only

VFO Frequency	433.00MHz
CALL Frequency (Memory Channel 0)	433.00MHz
Memory Channel 1~9	Nothing
Shift Direction	Simplex
Offset Frequency	7.6MHz
Tone Setting	Nothing
Tone Frequency	88.5Hz (option)
Channel Step	5 kHz

DJ-480C version only

VFO Frequency	433.00MHz
CALL Frequency (Memory Channel 0)	433.00MHz
Memory Channel 1~9	Nothing
Shift Direction	Simplex
Offset Frequency	7.6MHz
Tone Setting	Nothing
Tone Frequency	88.5Hz (option)
Channel Step	12.5 kHz

5. Ni-Cd BATTERY PACK

EBP-26N

5-1 NOTES

1. The battery pack is not charged when shipped. It must be charged before using.
2. Charging should be conducted in the temperature range of 0°C to 45°C, as incomplete charging or deterioration of battery performance may occur if charged outside this range.
3. Do not modify, dismantle, incinerate or immerse the battery pack in water as this may be dangerous. Be careful not to drop the battery pack or subject it to any severe shocks.
4. Never short-circuit the upper surface of the battery pack output terminals, as this may cause damage to the equipment or lead to heating of the battery which may cause burns.
5. Unnecessarily prolonged charging (overcharging) may result in deterioration of battery performance.
6. The battery pack should be stored in a dry place with a temperature range of -20°C to +45°C. Temperatures outside this range or extremely high levels of humidity may lead to leaking of the battery liquid or corrosion of the metal components of the batteries.
7. Normally the battery pack can be charged up to 300 times. However, the battery pack can be considered to be exhausted if the period of use drops off markedly despite being charged for the above mentioned time. When this happens, a new pack should be used.
8. We recommend fully depleting batteries before charging; this will prolong the life of Ni-Cd batteries.

5-2 CHARGING WITH EDC-49 OR EDC-50 (Normal Charger)

1. Mount the Ni-Cd battery pack in the charger.
2. Optimum charge time for a fully depleted battery is 14 hours.

5-3 SPECIFICATIONS

Battery Capacity: 700mAh
Output Voltage: 7.2V

6. CHARGER

EDC-49 (for 117V)
EDC-50 (for 220~240V)

6-1 INSTALLATION

Insert the battery-pack fully into the charger unit, matching the grooves.

6-2 CAUTIONS

1. Turn off the transceiver power while charging.
2. Never charge the battery packs of other makes with this Charger.

3. The required charging time depends on the conditions and the models of battery pack. Refer to the instruction manuals of the battery pack.
4. Never short-circuit the charging terminals of this Charger with a metal object, etc. for the charger may be damaged by a surge current.

7. INSTALLING OPTIONAL UNITS

EJ-14U 50ch Memory Unit
EJ-15U 200ch Memory Unit
EJ-17U CTCSS Unit

1. On the bottom of the transceiver, take off the bottom piece by unscrewing 4 corner positions.

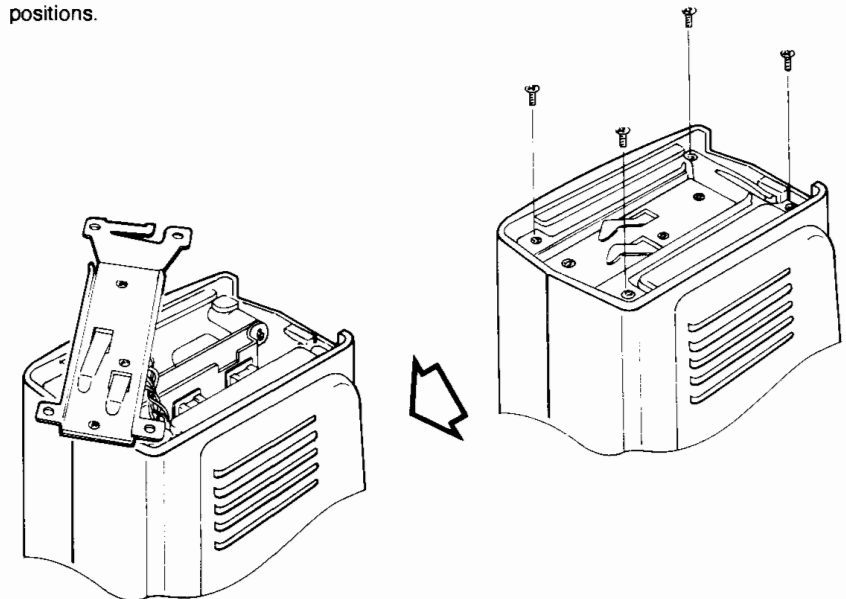

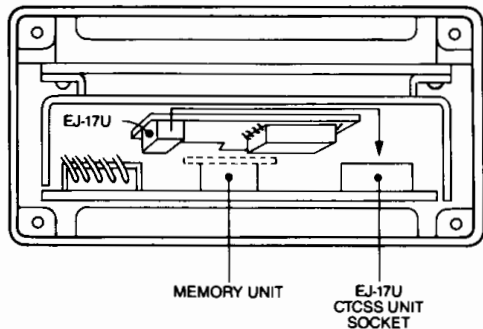
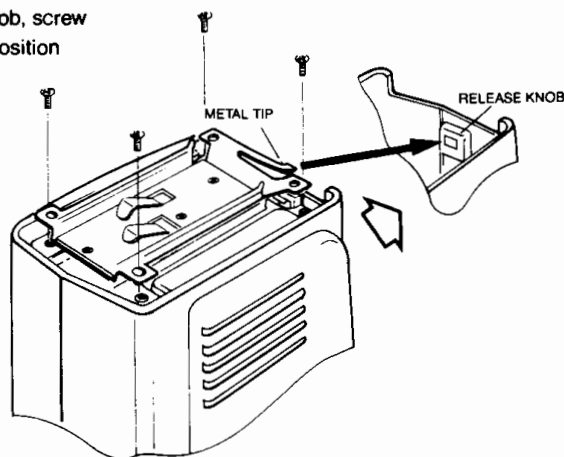
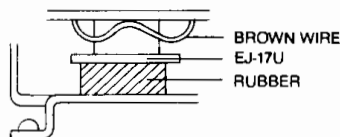
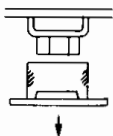

Fig. 1.

2. Using tweezers, hold the shaded area to lift off the memory unit. If you are installing EJ-14U or EJ-15U, install it here and see step (7). If you are installing EJ-17U take off the memory unit now for further maneuver.
3. Install EJ-17U from the direction shown in Fig. 1.
4. Insert the rubber piece provided between EJ-17U and the chassis.
5. Cut the brown wire.
6. Re-install the memory unit taken out in step (2).
7. Hooking the metal tip of bottom piece to the square hole of the release knob, screw the bottom piece to the original position with 4 screws.



IMPORTANT SAFETY INSTRUCTIONS

1. **SAVE THESE INSTRUCTIONS** — This manual contains important safety and operating instructions for battery charger Model EDC-49.
2. Before using battery charger, read all instructions and cautionary markings on (1) battery charger, (2) battery, and (3) product using battery.
3. **CAUTION** — To reduce risk of injury, charge only Ni-Cd type EBP-26N, EBP-28N rechargeable batteries.
Other types of batteries may burst causing personal injury and damage.
4. Do not expose charger to rain or snow.
5. Use of an attachment not recommended or sold by the battery charger manufacturer may result in a risk of fire, electrical shock, or injury to persons.
6. To reduce risk of damage to electric plug and cord, pull by plug rather than cord when disconnecting charger.
7. Make sure cord is located so that it will not be stepped on, tripped over, or otherwise subjected to damage or stress.
8. An extension cord should not be used unless absolutely necessary. Use of improper extension cord could result in a risk of fire and electric shock. If extension cord must be used, make sure:
 - a. That pins on plug of extension cord are the same number, size, and shape as those of plug on charger;
 - b. That extension cord is properly wired and in good electrical condition; and
 - c. That wire size is No. 18AWG, minimum and that cord is not over 100 feet (30.48m).
9. Do not operate charger with damaged cord or plug, replace them immediately.
10. Do not operate charger if it has received a sharp blow, been dropped, or otherwise damaged in any way; take it to a qualified serviceman.
11. Do not disassemble charger; take it to a qualified serviceman when service or repair is required. Incorrect reassembly may result in a risk of electric shock or fire.
12. To reduce risk of electric shock, unplug charger from outlet before attempting any maintenance or cleaning. Turning off controls will not reduce this risk.