

---

# Forty - 9er QRP 3W Kit

## CW Receiver Transmitter 7.023 Mhz

### Suite manual V1.0

#### A simple introduction

The original design from the United States NoCal QRP club's famous "Forty - 9er" suite, has carried on the localization design by the home fans after, this machine has a large number of users.

the output power up to 3 w, power output by American magnetic ring, make its have strong ability of remote communication, enhance the practicability of Forty - 9er!

This manual only for Forty - 9er v1.0 version of hardware is described.

#### Main indicators

Power supply: 12 v (linear regulated power supply) is recommended for the Antenna: 50 ohms, is not balanced

Receive: static current 20 ma

Emission current: 250 ma

Transmission power: 3 W

Frequency: launch the vibration frequency, 7023 KHZ;

receives the local oscillator frequency: about

7023-7023 KHZ work mode: the CW

#### Note:

in the process of sending, please don't touch Y2, and Y2 beside component.

Otherwise it will cause power tube D882 damage.

#### Circuit principle

Receiving part is the core of a NE602, inside it includes an oscillating circuit and a balanced mixer, antenna in the signal after a crystal filter, into the mixer, oscillation circuit at the receiving frequency oscillation, two signals through mixing, directly put the CW signal frequency conversion for audio, NE602 output again gave LM386 audio amplifier, thus complete the receiving process. Circuit consisting of Q4 audio oscillator to produce about 700 hz sine wave side tone, LM386 amplification, make the headset with "di tick" audio transmission. Launch part using the NE602 oscillation circuit, and then to Q6 do the buffer amplifier, at the end of the class is made up of class C D882 amplifier, after amplification of the high frequency signal after LPF filtering antenna.

#### Component selection

Choose around 130, 8050 magnification D882 magnification selection around 200. L3 is HFC, ferrite beads in FT37-43 (black) to use the 0.5 mm enameled wire around 11 times.

L4 is the high frequency filter inductance in T37-2 on the iron core is circular and (red) using 16 to 0.5 mm enameled wire around.

Inductance is a fixed color ring inductance, such as 100 uh 100 mh inductance for cylinder fixed inductance (outsourcing black heat shrinkable casing). Other devices, such as 0.47 uF for monolithic capacitors, more than 10 uF capacitance for aluminum electrolytic capacitors, all resistance is a quarter w fixed resistance.

## Installation and debugging

Before you install all components all the transistor, resistor, capacitor with a multimeter test again. And then control circuit diagram and the identity of the PCB mounting of all components. General compliance installation sequence of low to high. If there is a solder short circuit after welding must be checked. To install socket in integrated circuit at the same time, this can effectively avoid the core of integrated circuit welding bad. Checked everything is in order, after turn on the juice and the power of positive and negative polarity must not be wrong. Insert the walkman headphones headphone socket, should be white noise could be heard. The antenna terminal connected to make a holiday 51 ohms resistor load, short answer the KEY press KEY (simulated), testing the machine current, is about 250 ma. Don't long time short answer the KEY launch, or D882 and false heat load is bigger, be damaged. On the antenna terminal connected, should be able to hear the noise larger or the CW signal, rotating plate 47 k potentiometer, the tones of the CW signal should change from on high. When debugging, crystal shell not grounding, in the condition of receiving touch Y1 enclosure, bigger noise in the headset means receiving essentially normal.

**Note, not without a dummy load or does not match the antenna signal directly, avoid damage to the circuit!**

### Method of use

This machine is a simple direct frequency transceiver, must use not bad Yu Quanchang half wave dipole antenna. Choose the interference is small, spread good opportunity for communication experiment, at the same time, it's best to make an appointment with friends. Communication distance in 150-150 km is guaranteed, main distance more see the propagation environment and operator's skills.

### Interface signal

Please refer to the below link power, antenna, key and headphones.

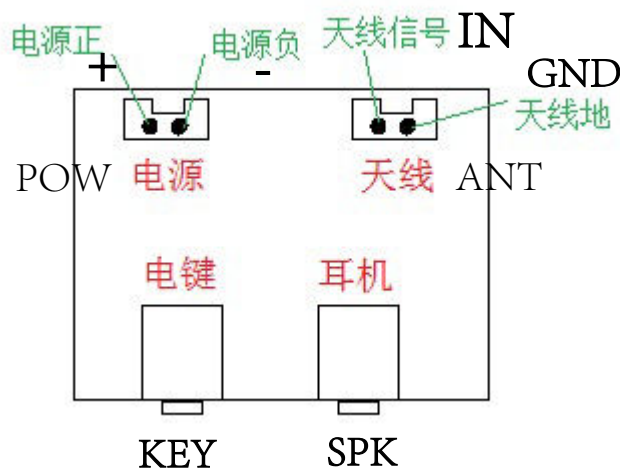

### Key interface

Key can be inserted into the socket 3 core stereo plug or 2 core mono plug, use with ordinary manual key specific attachment see figure.

# Forty-9erV1.0 QRP 3W Kit CW Receiver Transmitter 7.023Mhz

## 元件清单Component listing

1/4W 固定电阻Fixed resistor		
R1,R4,R10,R11	1K	
R2	220K*	Bias resistors 100K to 1M
R3,R12	10K	
R5	100K	
R6,R13	18K	
R7,R8	10 欧	
R9	47K	
R14	200 欧	
可变电阻Electrolytic capacitor		
W1	47K (473)	
固定电感Fixed inductance		
L1	100mH (8*10 工字电感 H inductor)	
L2	100uH (色环电感Color ring inductance)	
L3	FT37-43 磁环black circular	11T
L4	T37-2 磁环Red circular	16T
瓷片电容Ceramics capacitors		
C1,C7,C9,C11,C12,C14, C20 ,CP9	0.1uF(104)	
C3,C6,C15	0.01uF(103)	
C2,C21	30pF or 33pF	
C4,C5,C10	82pF	
C8	0.47uF (474) 	独石电容 Monolithic capacitors
C16,C17,C18	470pF (471)	
C13,C19,C22	0.047uF (473)	
电解电容Electrolytic capacitor		
CP1, CP4,CP7	100uF /25V	
CP2,CP3,CP5,CP6,CP8	10uF /25V	
CP10	1uF /50V	
晶体管transistor		
D1,D3,D5,D6	1N4148	
D2,D4	1N4001	
Q1	2SK30A	
Q2,Q4,Q6	8050	
Q3	8550	

Q5	D882	
集成电路 IC		
U1	78L08 (TO92)	
U2	NE602 (DIP8)	
U3	LM386 (DIP8)	
晶体crystal		
Y1,Y2	7.023MHz	
其他元件Other components		
J3,J4	2pin	
J2	3.5mm	KEY (插入电键)
J1	3.5mm	SPK (插入耳机)
PCB ×1		
直径 0.5mm 漆包线一段		
51 欧姆 1W 的电阻，用于充当假负载进行测试。		
51 ohms resistor, it is dummy load test		

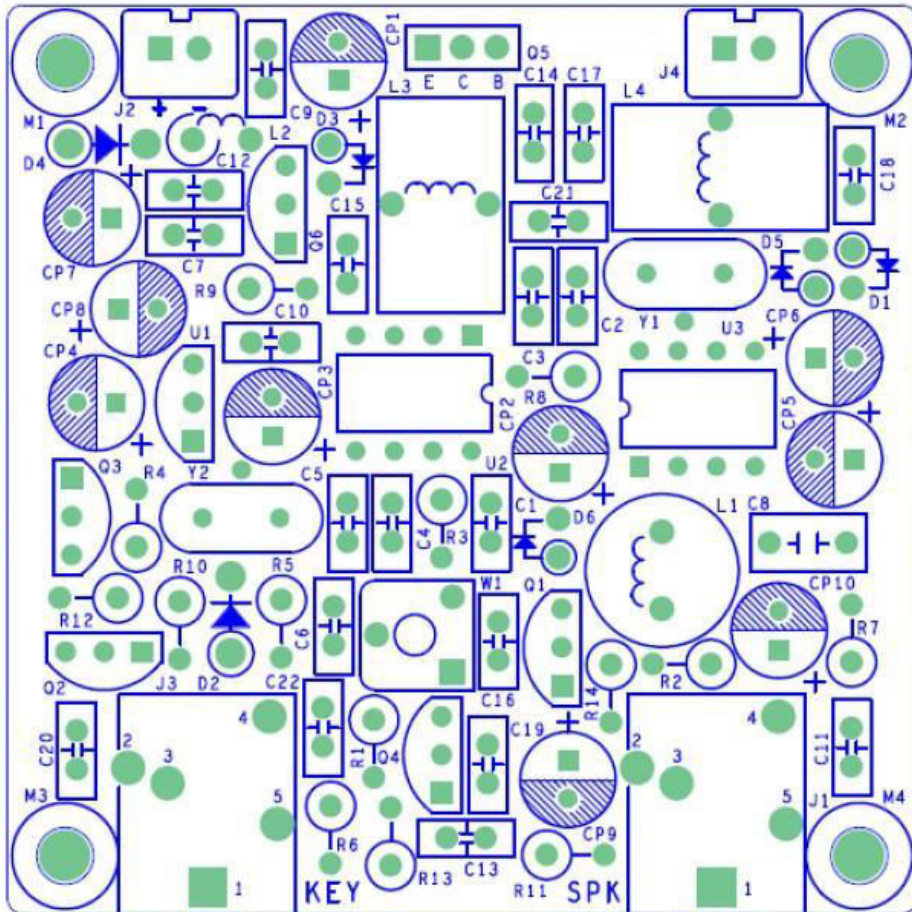

# Forty-9erV1.0

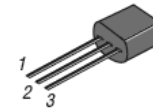

78L08 8050 8550  
2SK30A

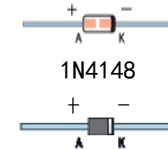

1N4148

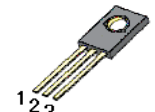

D882

1N4001

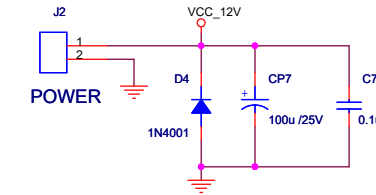
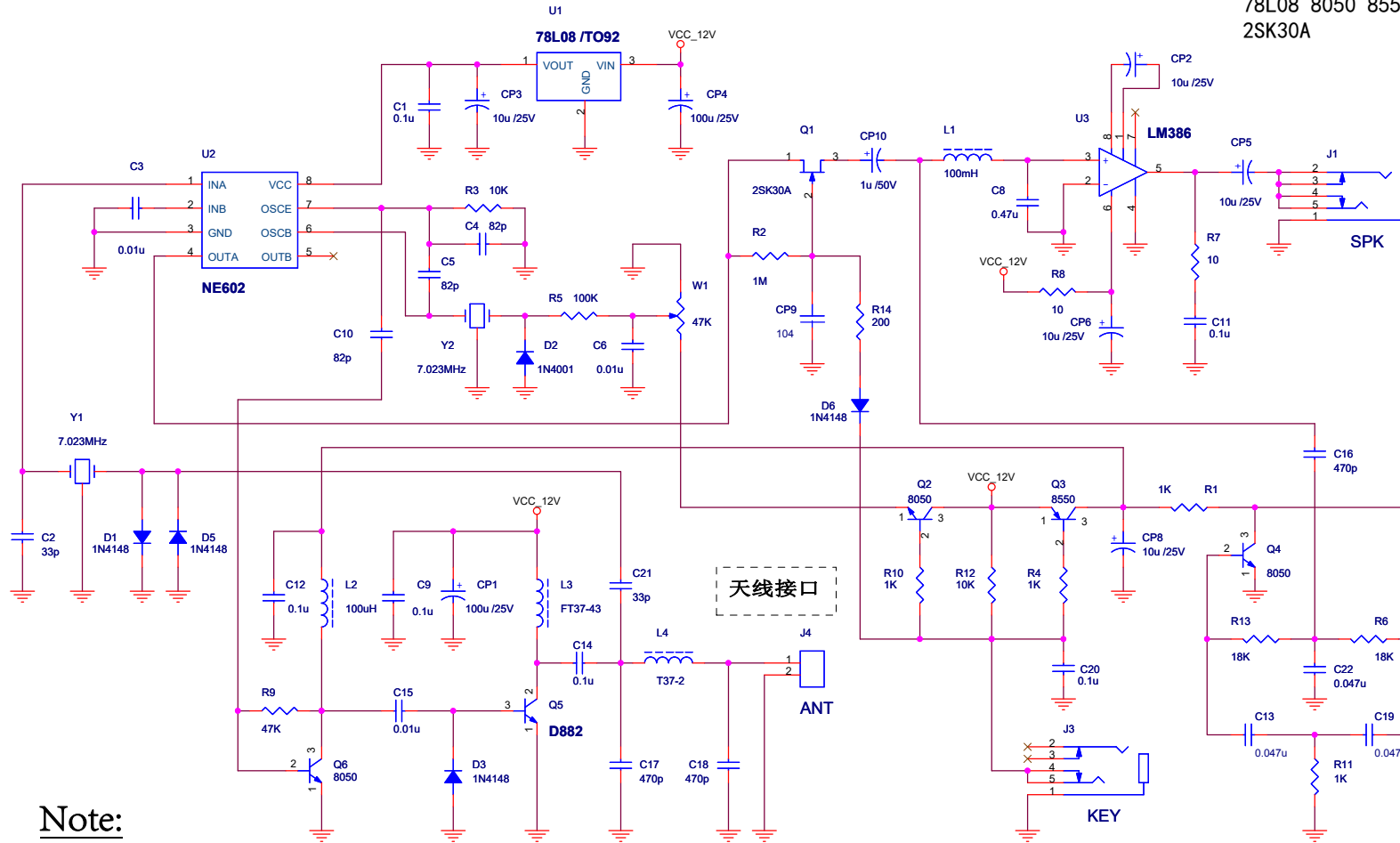

12v电源输入

## Note:

in the process of sending, please don't touch Y2, and Y2 beside component. Otherwise it will cause power tube D882 damage.



Title		
01.MAIN		
Size	Document Number	Rev
A3	Forty-9erV1.0	5.0
Date:	Monday, February 24, 2014	Sheet 1 of 1