

AR5000 service manual table of contents 1

	Page
Theory of operation -----	(1)
Signal block diagram -----	(2)
RX vs 1 st Local oscillator frequencies -----	(3) – (4)
Testing block diagram -----	(5)
Special probes -----	(6)
Sensitivity measuring condition -----	(7)
ALIGNMENT	
IF board -----	(8) – (10)
PLL board -----	(11) – (12)
FRONT board -----	(13) – (21)
AFC board -----	(22)
SAM board -----	(23)
NB board -----	(24)
DC VOLTAGES	
FRONT board -----	(25) – (29)
PLL board -----	(30) – (32)
IF board -----	(33) – (35)
AUDIO POWER board -----	(36)
POWER UNIT board -----	(37)
RF LEVELS	
FRONT board -----	(38) – (39)
PLL/STD/VCO/SUB CAR/LOCALs -----	(40) – (41)
IF board -----	(42)
REPAIR FLOW CHART	
PLL ERROR -----	(43) – (51)
WAVE FORMS	
PLL -----	(52) – (72)
FRONT -----	(73) – (81)
IF -----	(82) – (85)

AR5000 service manual table of contents 2

Page

PARTS LIST

FRONT board -----	(86) – (89)
CPU board -----	(90)
PLL board -----	(91) – (93)
NCO board -----	(94)
IF board -----	(95) – (98)
455 filter board -----	(99)
AUDIO BPF board -----	(100)
AUDIO board -----	(101)
VR/CPU-SUB/CTCSS -----	(102)
POWER board -----	(103)
POWER SUB/REMOTE -----	(104)
AFC board -----	(105)
SAM board -----	(106)
NB board -----	(107)
MISCELLANEOUS -----	(108)

ILLUSTRATIONS

Exploded view -----	(109)
Front panel assembly -----	(110)

PARTS LAYOUT/PATERNES

CPU SUB -----	(111) – (112)
AF -----	(113) – (114)
POWER -----	(115) – (116)
REMOTE -----	(117) – (118)
AFC -----	(119) – (120)
SAM -----	(121) – (122)
NB -----	(123) – (124)
FRONT -----	(125) – (126)
IF -----	(127) – (128)
CPU -----	(129) – (130)
PLL -----	(131) – (132)

AR5000 service manual table of contents 3

	Page
BLOCK DIAGRAM -----	(133)
SCHEMATIC DIAGRAMS	
RF board -----	(134)
PLL board -----	(135)
CPU board -----	(136)
IF board -----	(137)

THEORY OF OPERATION

Block diagram

Refer to page 133. The AR5000 is wide range communications receiver operating in the range of 10kHz - 2600MHz continuous. It consists of a tripple conversion superheterodyne receiver.

RF circuits

Signal input from antenna connectors is switched to a selected band pass filter (BAND 1 - BAND 17) through 4 mechanical relays and 3 attenuators. 12 pcs. of band pass filters(BAND 4 - BAND 15) for 500kHz - 1000MHz range are electronically preset tuning on receiving frequency for better performance. BAND 1 is low pass filter, BAND 2 & 3 are not exist, BAND 16 & 17 are combination of high pass filters and low pass filters.

6 pcs. RF amplifiers are provided for the total frequency range and one AIP amplifier which has no gain is for below 230MHz to get better intercept point when RF amplifier is OFF.

Mixers

2 pcs. 1st mixers provided, 1stMIX-1 (DBM-2 NIS-502) for above 400MHz and 1stMIX-2 (DBM-1 NIS-501) for below 400MHz. 1st IF is 622.0-622.4 MHz (400kHz bandwidth).

2nd mixer (DBM-1 NIS-501) makes 2nd IF of 10.7MHz.

3rd mixer (part of MC3372) makes 3rd IF of 455kHz with 10.245MHz crystal oscillator inside of the same IC MC3372.

2nd IF 10.7MHz output socket is provided at the rear panel of the AR5000 for optional spectrum display unit (wide band) and other purposes (selected bandwidth).

IF filters

1st IF filter is 622.2MHz centered +/-200kHz band pass filter.

6 pcs. 2nd IF filters(10.7MHz) selectable as indicated.

6 pcs. builtin 3rd IF filters(455kHz) selectable and 3 optional Collins mechanical filters can be installed.

Local oscillators

1st local injection of 622.400MHz - 2022.000MHz

2nd local injection of 611.700MHz → 611.300MHz for 10kHz-1400MHz range
611.300MHz → 611.700MHz for 1400-2600MHz range

3rd local injection of 10.245MHz crystal oscillator.

3rd IF amplifier/detector

Two amplifiers provided for 455kHz 3rd IF stages, one for FM by MC3372 combination IC, other for SSB/CW by 3 stage 3SK131 FET discrete amplifier and additional bipolar transistor stage for AM detection.

Audio stage

Signal from each detector is selected by analog switch and passes through HPF high pass filter and LPF low pass filter for suitable audio response per detection mode then amplified for 1.7W audio power to the internal speaker.

AR5000 TESTING BLOCK DIAGRAM

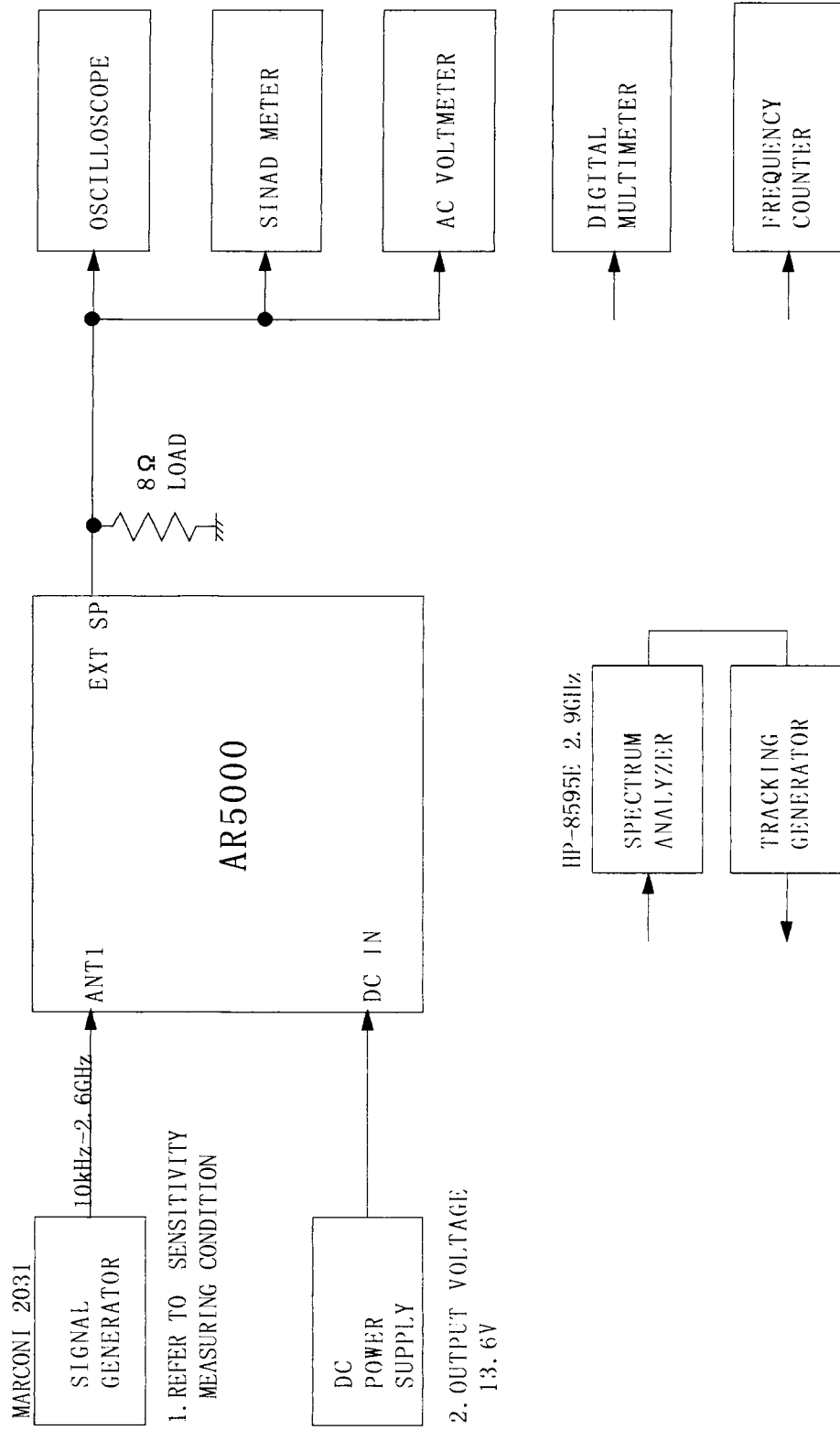

AR5000 SPECIAL PROBES

1. AC

- ① AC VOLTAGE IN PLOT DATA
- ② USE DC CUT CABLE

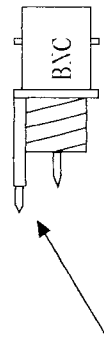

SPRING LOADED PINS

2. DC

- ① DC VOLTAGE IN PLOT DATA

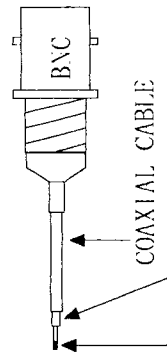

SIGNAL GND
SOLDER

3. DC1

- DC1 INDICATION IN PLOT DATA

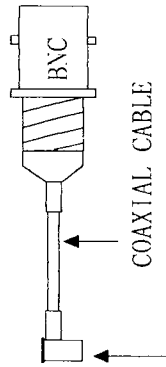

COAXIAL CONNECTOR

4. DC2

- ① DC2 INDICATION IN PLOT DATA

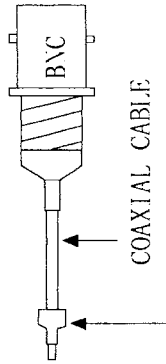

COAXIAL CONNECTOR

AR5000 SENSITIVITY MEASURING CONDITION

1. FM (12dB SINAD)

AR5000				SIGNAL GENERATOR		REMARKS
IFBW	AUDIO FILTER		FM-DEV		MAX-DEV	
	HPF	LPF	STD-DEV			
6KHz	0.3 KHz	3.0 KHz	750 μS	1.75 KHz	2.50 KHz	1. WITH STANDARD DEVIATION
15KHz	0.3 KHz	3.0 KHz	750 μS	3.50 KHz	5.00 KHz	
30KHz	0.05 KHz	12.0 KHz	75 μS	7.00 KHz	10.00 KHz	
110KHz	0.05 KHz	12.0 KHz	75 μS	25.00 KHz	35.00 KHz	
220KHz	0.05 KHz	12.0 KHz	75 μS	50.00 KHz	75.00 KHz	

2. AM (10dB S/N)

AR5000				SIGNAL GENERATOR		REMARKS
IFBW	AUDIO FILTER		DE-EMPHASIS	AM-MOD		
	HPF	LPF		STD-MOD	MAX-MOD	
6KHz	0.3 KHz	3.0 KHz	THROUGH	60%		1. WITH STANDARD DEVIATION
15KHz	0.3 KHz	3.0 KHz	THROUGH	60%		
30KHz	0.05 KHz	12.0 KHz	THROUGH	60%		
110KHz	0.05 KHz	12.0 KHz	THROUGH	60%		
220KHz	0.05 KHz	12.0 KHz	THROUGH	60%		

3. SSB/CW (12dB SINAD)

AR5000				SIGNAL GENERATOR		REMARKS
IFBW	AUDIO FILTER		DE-EMPHASIS	MOD		
	HPF	LPF		STD-MOD	MAX-MOD	
0.5 KHz	0.2 KHz	3.0 KHz	THROUGH	OFF		1. 1KHz CW PITCH
3.0 KHz	0.2 KHz	3.0 KHz	THROUGH	OFF		

AR 5000 I F - P C B A L I G N M E N T 1 / 3

ITEM	RX FREQ MHz	MODE	STEP KHz	BW KHz	AGC	MEASURE POINT	ADJUST PART	SPECIFIED VALUE	SG SET FREQ MHz	LEVEL dBm	MOD	REMARKS	
1	AGC START	129.900	FM	25	15	ON	TP-5	VR2	4.55V + 0.02V - 0.03V	129.900	OFF	OFF	
2	RF GAIN START	129.900	FM	25	15	ON	TP-5	VR3	4.55V + 0.02V - 0.03V	129.900	OFF	OFF	1.SQ-VR (FRONT PANEL) SET FULLY COUNTER CLOCK WISE CCW POSITION
3	S-METER OFFSET	129.900	FM	25	15	ON	TP-8	VR4	4.40V + 0.02V - 0.02V	129.900	OFF	OFF	
4	10.7MHz MCF 15KHz	129.900	FM	25	15	OFF	T2,T6 T8	REFER IF1 - C	129.900	OFF	OFF	1.INPUT,OUTPUT & OTHER CONDITIONS REFERRED TO IF1 - C 2.T2,T6 (WAVE SHAPE) REFER IF1 - C WAVE SHAPE ADJUST REPEATEDLY 3.T8 (PEAK) ADJUST FOR PEAK	
5	10.7MHz MCF 6KHz	129.900	FM	25	6	OFF		REFER IF1 - B	129.900	OFF	OFF	CHECK ONLY	
6	10.7MHz MCF 3KHz	129.900	FM	25	3	OFF		REFER IF1 - A	129.900	OFF	OFF	CHECK ONLY	
7	10.7MHz MCF 30KHz	129.900	FM	25	30	OFF	T4,T5	REFER IF1 - D	129.900	OFF	OFF	1.T4,T5 (WAVE SHAPE) REFER IF1 - D WAVE SHAPE ADJUST REPEATEDLY	
8	10.7MHz MCF 110KHz	129.900	FM	25	110	OFF	VR8	BW=15KHz (ref) - 5dB + 3dB REFER IF2 - A	129.900	OFF	OFF	1.VR8 (LEVEL) ADJUST ON LOW LEVELLED BW 2.AFTER ADJUSTMENT CHECK IF BOTH BW ARE IN SPECS.	
9	10.7MHz MCF 220KHz	129.900	FM	25	220	OFF	VR8	REFER IF2 - B	129.900	OFF	OFF		
10	10.7MHz EXT	129.900	FM	25	15	OFF	T3	REFER IF2 - C	129.900	OFF	OFF	1.T3 REFER IF2 - C WAVE SHAPE	

AR 5 0 0 0 I F - P C B A L I G N M E N T 2 / 3

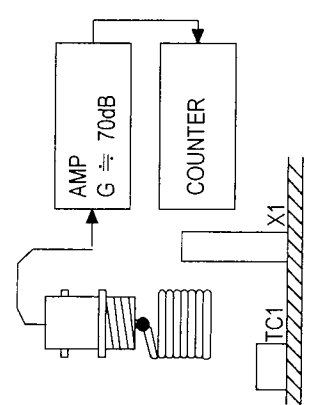
ITEM	RX FREQ MHz	MODE	STEP KHz	BW KHz	AGC	MEASURE POINT	ADJUST PART	SPECIFIED VALUE	SG SET FREQ MHz	LEVEL dBm	MOD	REMARKS
11 10.245MHz (FREQUENCY)	129.900	FM	25	15	ON		TC1	10.245MHz + 10Hz - 10Hz				1. REFER BELOW FIGURE FOR ADJUSTMENT ① PICK UP COIL WIRE SIZE : 1.0mm dia. INNER DIA. : 10mm NO. OF TURNS : 7 ② AMP GAIN : APPROX. 70dB
12 IFT	129.900	FM	25	15	ON	S-METER	T7		129.900	- 108	OFF	 1. INPUT ANT1 2. VR1 PRESET S2 ON THE S-METER 3. T7 (PEAK) ADJUST FOR PEAK ON THE S-METER
13 IFT	129.900	FM	25	15	ON	S-METER	T10, T11, T12		129.900	- 108	OFF	1. INPUT ANT1 2. VR1 PRESET S2 ON THE S-METER 3. T10, T11, T12 (PEAK) ADJUST FOR PEAK ON THE S-METER

A R 5 0 0 0 I F - P C B A L I G N M E N T 3 / 3

ITEM	RX FREQ MHZ	MODE	STEP KHZ	BW KHZ	AGC	MEASURE POINT	ADJUST PART	SPECIFIED VALUE	SGSET FREQ MHZ	LEVEL dBm	MOD	REMARKS
14 S-METER S1	129.900	FM	25	15	ON	S-METER	VR1	S1	129.900	- 108	OFF	
15 ATT AUTO THRESHOLD	129.900	FM	25	15	ON	TP-9	VR6	4.30V + 0.05V - 0.05V	129.900	- 25	OFF	
16 AGC MAX	129.900	FM	25	15	ON	TP-9	VR6	4.70V + 0.20V - 0.20V	129.900	0	OFF	1. IF IN SPECS. PROCEED TO (17) 2. IF OUT OF SPECS. ① VR6 RE-ADJUST FOR SPECS. ② AFTER RE-ADJUSTMENT CHECK IF (15) IS IN SPECS. ③ ADJUST FOR WANTED SPECS. ON BOTH 15 & 16
17 S-METER + 60dB	129.900	FM	25	15	ON	S-METER	VR7	S + 60dB	129.900	0	OFF	
18 L-SQL MAX	129.900	FM	25	15	ON	TP-9	VR5	4.70V + 0.05V - 0.05V	129.900	OFF	OFF	1. ADJUST AT L-SQL VALUE OF 255

AR 5 0 0 0 PLL -- PCB ALIGNMENT 1 / 2

ITEM	RX FREQ MHZ	MODE	STEP KHZ	BW KHZ	AGC	MEASURE POINT	ADJUST PART	SPECIFIED VALUE	REMARKS
1 FILTER -- A	0.010	FM	25	15	ON		L29,L55	REFER PLL1 -- A	1.REFER PLL1 -- A FOR INPUT, OUTPUT & OTHER CONDITIONS 2.L29,L55 (WAVE SHAPE) ADJUST REFERING PLL1 -- A
2 FILTER -- B	129.900	FM	25	15	ON		L39,L40,L41,L42	REFER PLL1 -- B	1.REFER PLL1 -- B FOR INPUT, OUTPUT & OTHER CONDITIONS 2.L39,L40,L41,L42 (WAVE SHAPE) ADJUST REFERING PLL1 -- B
3 FILTER -- C	500.900	FM	25	15	ON		L34,L35,L36,L38	REFER PLL1 -- C	1.REFER PLL1 -- C FOR INPUT, OUTPUT & OTHER CONDITIONS 2.L34,L35,L36,L38 (WAVE SHAPE) ADJUST REFERING PLL1 -- C
4 FILTER -- D	1000.90	FM	25	15	ON		L50,L51,L52,L54	REFER PLL1 -- D	1.REFER PLL1 -- D FOR INPUT, OUTPUT & OTHER CONDITIONS 2.L50,L51,L52,L54 (WAVE SHAPE) ADJUST REFERING PLL1 -- D
5 FILTER -- E	800.900	FM	25	15	ON		L43,L44,L45 L47,L48,L49	REFER PLL2 -- A	1.REFER PLL2 -- A FOR INPUT, OUTPUT & OTHER CONDITIONS 2.L43,L44,L45 (WAVE SHAPE) L47,L48,L49 (WAVE SHAPE) ADJUST REFERING PLL2 -- A
6 FILTER -- F	1200.90	FM	25	15	ON		L26,L27,L28 L31,L32,L33	REFER PLL2 -- B	1.REFER PLL2 -- B FOR INPUT, OUTPUT & OTHER CONDITIONS 2.L26,L27,L28 (WAVE SHAPE) L31,L32,L33 (WAVE SHAPE) ADJUST REFERING PLL2 -- B

AR 5000 PLL - PCB ALIGNMENT 2 / 2

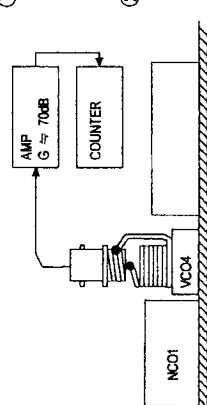
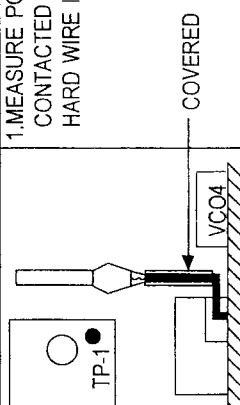
ITEM	RX FREQ MHz	MODE	STEP MHz	BW KHz	AGC	MEASURE POINT	ADJUST PART	SPECIFIED VALUE	REMARKS
7 FILTER - J	129.900	FM	25	15	ON		T1,T2	REFER PLL3 - C	1.REFER PLL3 - C FOR INPUT, OUTPUT & OTHER CONDITIONS 2.T1,T2 (WAVE SHAPE) ADJUST REFERING PLL3 - C 3.OFF CENTER IS INTENTIONAL
8 TCXO (FREQUENCY)	600.000	FM	25	15	ON	J1	TCXO1	1222.400MHZ + 100Hz - 100Hz	1.TCXO1 CRITICAL AND CAREFULL ADJUSTMENT REQUIRED
9 NCO (FREQUENCY)	129.900	FM	25	15	ON	P1-3	C17	16.777216MHZ + 10HZ - 10HZ	 <p>① PICK UP COIL WIRE SIZE : 1.0mm dia. INNER DIA : 1.0mm NO. OF TURNS : 7</p> <p>② AMP GAIN : APPROX. 70dB</p>
10 SUBCARRIER (VCV)	129.900	USB	25	15	ON	TP1	T3	5.00V + 1.0V - 0.5V	1.MEASURE POINT (TP1) CAN BE CONTACTED BY SPECIAL MADE HARD WIRE INSULATED
11 SUBCARRIER (VCV)	129.900	LSB	25	15	ON	TP1	T3	2.0V ~ 6.0V	 <p>COVERED WITH INSULATED TUBE</p> <p>1.IF IN SPECS. PROCEED TO NEXT</p> <p>2.IF OUT OF SPECS (less than 2.0V)</p> <p>① T3 RE-ADJUST FOR THE SPECS ② AFTER RE-ADJUSTMENT CHECK IF (10) IS IN SPECS</p> <p>③ ADJUST FOR BOTH 10,11 SPECS.</p>

AR 5000 FRONT - PCB ALIGNMENT 1 / 9

ITEM	RX FREQ MHZ	MODE	STEP KHZ	BW KHZ	AGC	MEASURE POINT	ADJUST PART	SPECIFIED VALUE	D / A VALUE (TUNE)	REMARKS
1 BAND14,15 (BIAS)	400.000	FM	25	15	ON	Q10-D	VR3	9.23V + 0.04V - 0.03V		
2 BAND16 (BIAS)	1000.000	FM	25	15	ON	R2 ● R5 R6 ● L9	VR1 VR2	4.23V + 0.04V - 0.03V 4.23V + 0.04V - 0.03V		1.NIS-165 2.BIAS VOLTAGE TENDS TO SHIFT A BIT 3. ● INDICATES JUNCTION POINT OF COMPONENTS
3 BAND17 (BIAS)	1600.000	FM	25	15	ON	R8 ● L8 R11 ● L18	VR3 VR4	4.23V + 0.04V - 0.03V 4.23V + 0.04V - 0.03V		1.NIS-165 2.BIAS VOLTAGE TENDS TO SHIFT A BIT 3. ● INDICATES JUNCTION POINT OF COMPONENTS
4 BAND1	0.010	FM	25	15	ON			REFER FRONT1 -- A		1.CHECK ONLY 2.REFER FRONT1 -- A FOR INPUT, OUTPUT AND OTHER CONDITIONS

AR 5000 FRONT - PCB ALIGNMENT 2 / 9

ITEM	RX FREQ MHZ	MODE	STEP KHZ	BW KHZ	AGC	MEASURE POINT	ADJUST PART	SPECIFIED VALUE	D / A VALUE (TUNE)	REMARKS
5 BAND4 (U)	0.899	FM	25	15	ON		T10	REFER FRONT2 -- B	210	1.REFER FRONT2-B FOR INPUT, OUTPUT & OTHER CONDITIONS 2.T10 (WAVE SHAPE) ADJUST REPEATEDLY REFERING FRONT2 -- B
6 BAND4 (L)	0.500	FM	25	15	ON		T10	REFER FRONT2 -- A	34	1.WITHIN SPECS. PROCEED TO (7) 2.OUT OF SPECS. ① T10 RE-ADJUST (5) WITHIN SPECS. BY OFF-CENTERING ② RE-CHECK IF WITHIN SPECS. ③ IN CASE OUT OF SPECS. REPEAT ①, ②
7 BAND5 (U)	1.999	FM	25	15	ON		T8	REFER FRONT2 -- D	230	1.REFER FRONT2-D FOR INPUT, OUTPUT & OTHER CONDITIONS 2.T8 (WAVE SHAPE) ADJUST REPEATEDLY REFERING FRONT2-D
8 BAND5 (L)	0.900	FM	25	15	ON		T8	REFER FRONT2 -- C	39	1.WITHIN SPECS. PROCEED TO (9) 2.OUT OF SPECS. ① T8 RE-ADJUST (7) WITHIN SPECS. BY OFF-CENTERING ② RE-CHECK IF WITHIN SPECS. ③ IN CASE OUT OF SPECS. REPEAT ①, ②

AR 5000 FRONT - PCB ALIGNMENT 3 / 9

ITEM	RX FREQ MHZ	MODE	STEP KHZ	BW KHZ	AGC	MEASURE POINT	ADJUST PART	SPECIFIED VALUE	D / A VALUE (TUNE)	REMARKS
9 BAND6 (U)	3.999	FM	25	15	ON	T7		REFER FRONT3 - B	230	1.REFER FRONT3-B FOR INPUT, OUTPUT & OTHER CONDITIONS 2.T7 (WAVE SHAPE) ADJUST REPEATEDLY REFERING FRONT3 - B
10 BAND6 (L)	2.000	FM	25	15	ON	T7		REFER FRONT3 - A	66	1.WITHIN SPECS. PROCEED TO (11) 2.IF OUT OF SPECS. ① T7 RE-ADJUST (9) WITHIN SPECS. BY OFF-CENTERING ② RE-CHECK IF IN SPECS. ③ IN CASE OUT OF SPECS. REPEAT ①, ②
11 BAND7 (U)	9.999	FM	25	15	ON	T6		REFER FRONT3 - D	220	1.REFER FRONT3-D FOR INPUT, OUTPUT & OTHER CONDITIONS 2.T6 (WAVE SHAPE) ADJUST REPEATEDLYREFERING FRONT3 - D
12 BAND7 (L)	4.000	FM	25	15	ON	T6		REFER FRONT3 - C	65	1.WITHIN SPECS. PROCEED TO (13) 2.IF OUT OF SPECS. ① T6 RE-ADJUST (11) WITHIN SPECS. BY OFF-CENTERING ② RE-CHECK IF IN SPECS. ③ IF OUT OF SPECS. REPEAT ①, ②

AR 5 0 0 0 FRONT - PCB ALIGNMENT 4 / 9

ITEM	RX FREQ MHz	MODE	STEP KHz	BW KHz	AGC	MEASURE POINT	ADJUST PART	SPECIFIED VALUE	D / A VALUE (TUNE)	REMARKS
13 BAND8 (U)	19.999	FM	25	15	ON	T5	T5	REFER FRONT4 -- B	193	1.REFER FRONT4-B FOR INPUT, OUTPUT & OTHER CONDITIONS 2.T5 (WAVE SHAPE) ADJUST REPEATEDLY REFERRING FRONT4 -- B
14 BAND8 (L)	10000	FM	25	15	ON	T5	T5	REFER FRONT4 -- A	35	1.WITHIN SPECS. PROCEED TO (15) 2.IF OUT OF SPECS. ① T5 RE-ADJUST (13) WITHIN SPECS. BY OFF-CENTERING ② RE-CHECK IF IN SPECS. ③ IF OUT OF SPECS. REPEAT ①, ②
15 BAND9 (U)	39.999	FM	25	15	ON	T4	T4	REFER FRONT4 -- D	195	1.REFER FRONT4-D FOR INPUT, OUTPUT & OTHER CONDITIONS 2.T4 (WAVE SHAPE) ADJUST REPEATEDLY REFERRING FRONT4 -- D
12 BAND9 (L)	20.000	FM	25	15	ON	T4	T4	REFER FRONT4 -- C	32	1.WITHIN SPECS. PROCEED TO (17) 2.IF OUT OF SPECS. ① T4 RE-ADJUST (15) WITHIN SPECS. BY OFF CENTERING ② RE-CHECK IF IN SPECS. ③ IF OUT OF SPECS. REPEAT ①, ②

AR 5000 FRONT - PCB ALIGNMENT 5 / 9

ITEM	RX FREQ MHZ	MODE	STEP KHZ	BW KHZ	AGC	MEASURE POINT	ADJUST PART	SPECIFIED	D / A VALUE (TUNE)	REMARKS
17 BAND10 (U)	74.999	FM	25	15	ON		T11	REFER FRONT5 - B	205	1.REFER FRONT5-B FOR INPUT, OUTPUT & OTHER CONDITIONS 2.T11 (WAVE SHAPE) ADJUST REPEATEDLY REFERING FRONT5 - B
18 BAND10 (L)	40000	FM	25	15	ON		T11	REFER FRONT5 - A	53	1.WITHIN SPECS. PROCEED TO (19) 2.IF OUT OF SPECS. ① T11 RE-ADJUST (17) WITHIN SPECS. BY OFF-CENTERING ② RE-CHECK IF IN SPECS. ③ IF OUT OF SPECS. REPEAT ①, ②
19 BAND11 (U)	149.999	FM	25	15	ON		T12	REFER FRONT5 - D	240	1.REFER FRONT5-D FOR INPUT, OUTPUT & OTHER CONDITIONS 2.T12 (WAVE SHAPE) ADJUST REPEATEDLY REFERING FRONT5 - D
20 BAND11 (L)	75.000	FM	25	15	ON		T12	REFER FRONT5 - C	52	1.WITHIN SPECS. PROCEED TO (21) 2.IF OUT OF SPECS. ① T12 RE-ADJUST (19) WITHIN SPECS. BY OFF-CENTERING ② RE-CHECK IF IN SPECS. ③ IF OUT OF SPECS. REPEAT ①, ②

AR 5 0 0 0 FRONT - PCB ALIGNMENT 6 / 9

ITEM	RX FREQ MHz	MODE	STEP KHz	BW KHz	AGC	MEASURE POINT	ADJUST PART	SPECIFIED VALUE	D / A VALUE (TUNE)	REMARKS
21 BAND12 (U)	229.999	FM	25	15	ON		L45,L46	REFER FRONT6 - B	230	1.REFER FRONT6-B FOR INPUT, OUTPUT & OTHER CONDITIONS 2.L45,L46 (WAVE SHAPE) ADJUST REPEATEDLYREFERING FRONT6 -- B
22 BAND12 (L)	150.000	FM	25	15	ON		L45,L46	REFER FRONT6 - A	39	1.WITHIN SPECS. PROCEED TO (23) 2.IF OUT OF SPECS. ① L45,L46 RE-ADJUST (21) WITHIN SPECS. BY OFF-CENTERING ② RE-CHECK IF IN SPECS. ③ IF OUT OF SPECS. REPEAT ①, ②
23 BAND13 (U)	399.999	FM	25	15	ON		L41,L42	REFER FRONT6 - D	139	1.REFER FRONT6-D FOR INPUT, OUTPUT & OTHER CONDITIONS 2.L41,L42 (WAVE SHAPE) ADJUST REPEATEDLY REFERING FRONT6-D
24 BAND13 (L)	230.000	FM	25	15	ON		L41,L42	REFER FRONT6 - C	14	1.WITHIN SPECS. PROCEED TO (25) 2.IF OUT OF SPECS. ① L41,L42 RE-ADJUST (23) WITHIN SPECS. BY OFF-CENTERING ② RE-CHECK IF IN SPECS. ③ IF OUT OF SPECS. REPEAT ①, ②

AR5000 FRONT-PCB ALIGNMENT 7 / 9

ITEM	RX FREQ MHz	MODE	STEP KHz	BW KHz	AGC	MEASURE POINT	ADJUST PART	SPECIFIED VALUE	D / A VALUE (TUNE)	REMARKS
25 BAND14 (U)	699.999	FM	25	15	ON	L23,L24	L23,L24	REFER FRONT7 - B	170	1.REFER FRONT7-B FOR INPUT, OUTPUT & OTHER CONDITIONS 2.L23,L24 (WAVE SHAPE) ADJUST REPEATEDLY REFERING FRONT7 - B
26 BAND14 (L)	400.000	FM	25	15	ON	L23,L24	L23,L24	別紙 FRONT7 - A	22	1.IF IN SPECS. PROCEED TO (27) 2.IF OUT OF SPECS. ① L23,L24 RE-ADJUST (25) WITHIN SPECS. BY OFF-CENTERING ②RE-CHECK IF IN SPECS. ③IF OUT OF SPECS. REPEAT ①, ②
27 BAND15 (U)	999.999	FM	25	15	ON	L20,L21	L20,L21	別紙 FRONT7 - D	165	1.REFER FRONT7-D FOR INPUT, OUTPUT & OTHER CONDITIONS 2.L20,L21 (WAVE SHAPE) ADJUST REPEATEDLY REFERING FRONT7 - D
28 BAND15 (L)	700.000	FM	25	15	ON	L20,L21	L20,L21	別紙 FRONT7 - C	71	1.IF IN SPECS. PROCEED TO (29) 2.IF OUT OF SPECS. ① L20,L21 RE-ADJUST (27) WITHIN SPECS. BY OFF-CENTERING ②RE-CHECK IF IN SPECS. ③IF OUT OF SPECS. REPEAT ①, ②

AR 5000 FRONT - PCB ALIGNMENT 8 / 9

ITEM	RX FREQ MHZ	MODE	STEP KHz	BW KHz	AGC	MEASURE POINT	ADJUST PART	SPECIFIED VALUE	D / A VALUE (TUNE)	REMARKS
29 BAND16	1000.000	FM	25	15	ON	L15		REFER FRONT8 -- A		1.REFER FRONT8-A FOR INPUT, OUTPUT & OTHER CONDITIONS 2.L15 (WAVE SHAPE) ADJUST REFERING FRONT8 -- A
30 BAND17	1600.000	FM	25	15	ON	L10,L19		REFER FRONT8 -- B		1.REFER FRONT8-B FOR INPUT, OUTPUT & OTHER CONDITIONS 2.L10,L19 (WAVE SHAPE) ADJUST REPEATEDLY REFERING FRONT8 -- B
31 FIRST IF FILTER	129.9000	FM	25	15	ON	T2,T3		REFR FRONT8 -- C		1.REFER FRONT8-C FOR INPUT, OUTPUT & OTHRE CONDITIONS 2.T2,T3 (WAVE SHAPE) ADJUST REPEATEDLY REFERING FRONT8 -- C

AR 5000 FRONT - PCB ALIGNMENT 9 / 9

ITEM	RX FREQ MHz	MODE	STEP KHz	BW KHz	AGC	MEASURE POINT	ADJUST PART	SPECIFIED VALUE	SG SET FREQ MHz	LEVEL dBm	MOD	REMARKS
32	0.030	AM	1	6	ON		TC1	MORE THAN 12dB SINAD	0.030	- 96	60%	1.INPUT ANT1 2.OUTPUT EXT SP ADJUST TC1 FOR BEST SINAD OF AUDIO OUTPUT
33	0.010	CW	1	3	ON		TC1	MORE THAN 12dB SINAD	0.010	- 80	OFF	1.IF IN SPECS. FINISH ALIGNMENT 2.IF OUT OF SPECS. ① TC1 RE-ADJUST FOR SPECS. ② AFTER RE-ADJUSTMENT, CHECK IF (32) MET IN SPECS. ③ ADJUST FOR BOTH 32,33 SPECS.

A R 5 0 0 0 A F C - P C B A L I G N M E N T 1 / 1

ITEM	RX FREQ MHz	MODE	STEP KHz	BW KHz	AGC	MEASURE POINT	ADJUST PART	SPECIFIED VALUE	SG SET FREQ MHz	LEVEL dBm	MOD	REMARKS
34 CENTER VOLTAGE (CARRIER ON)	129.900	FM	1	15	ON	TP1 (IC3-7)	T2	$\frac{137}{256} \times \text{AVref}$ + 0.03V - 0.03V	129.900	- 50	OFF	1.AFC ADJUST AT AFC OFF 2.INPUT ANT1 3.AVref (A / D reference) J6-5 (POWER-PCB) 4.CENTER VOLTAGE SHOULD BE CALICULATED BY EACH AVref PECULIAR TO
35 CENTER VOLTAGE (CARRIER OFF)	129.900	FM	1	15	ON	TP1 (IC3-7)	T1	$\frac{137}{256} \times \text{AVref}$ + 0.03V - 0.03V	129.900	OFF	OFF	1.AFC ADJUST AT AFC OFF 2.INPUT ANT1
36 TRACKING	129.900	FM	1	15	ON	LCD (FREQ)		FOR SG FREQ + 1.5KHz - 1.5KHz	129.900 + 25KHz - 25KHz	- 50	OFF	1.CHECK TRACKING WITH +/-25kHz CHANGE OF SG FREQUENCY

AR 5000 SAM - PCB ALIGNMENT I / 1

ITEM	RX FREQ MHz	MODE	STEP KHz	BW KHz	AGC	MEASURE POINT	ADJUST PART	SPECIFIED VALUE	SG SET FREQ MHz	LEVEL dBm	MOD	REMARKS
37 SAM SAL SAH	129.900	SAM SAL SAH	25	15	ON		T3,T4	SAM MORE THAN 35dB SAL,SAH MORE THAN 30dB WHERE: BW=6kHz SAL,SAH BW=3kHz WHEN [ENT] IS PUSHED	129.900	- 50	60%	1.INPUT ANT1 2.OUTPUT EXT SP 3.T3,T4 ADJUST FOR BEST S/N OF AUDIO OUTPUT 4.CHECK S/N AT SAL, SAH 5. IF IN SPECS. FINISH ALIGNMENT 6.IF OUT OF SPECS. ① T3,T4 RE-ADJUST AT WORSE MODE ② AFTER RE-ADJUSTMENT, CHECK S/N AT SAM,SAL,SAH FINISH IF IN SPECS. IF NOT REPEAT ADJUSTMENT 7. IF S/N POOR, TRY TO RE-ROUTE WIRINGS FOR BEST S/N 8. SENSIBLE WIRINGS ON SAM, AFC UNITS

AR 5 0 0 0 NB - PCB ALIGNMENT 1 / 1

ITEM	RX FREQ MHz	MODE	STEP KHz	BW KHz	AGC	MEASURE POINT	ADJUST PART	SPECIFIED VALUE	SG SET FREQ MHz	LEVEL dBm	MOD	REMARKS
38 NB (OFF)	129.900	FM	25	15	OFF	TP1 (R40 -- C32)	T1, T2, T5	4.0V + 1.0V -- 1.0V	129.900	-- 95	OFF	1.INPUT ANT1 2.OUTPUT EXT SP 3.T1,T2,T5 SET SG LEVEL FOR APPROX. 4.0V AT MEASURING POINT THEN ADJUST TRANSFORMERS FOR MINIMUM VOLTAGE
39 NB (ON)	129.900	CW	25	15	OFF		VR1					1.AFTER ALL OTHER ALIGNMENT 2.VR1 ① NB ON TURN CLOCKWISE FROM CCW ② POSITION AND STOP AT NOISE DISAPPEARED 3.APPROX. QUARTER TURN EXPECTED FOR NOISE DISAPPEAR POINT 4.NOISE GENERATION BY RELAY SELF CONTACT SWITCHING

AR5000 FRONT UNIT DC VOLTAGE

PARTS NO,	NAME	PIN NO	LEVEL (V)	REMARKS
IC6	FMC5	2 / 5	+4.9V / +9.6V	ANT2 (M-TYPE) CHOICE
IC6	FMC5	2 / 5	0.0V / 0.0V	ANT1 (N-TYPE) CHOICE
IC7	FMC5	2 / 5	+4.9V / +9.6V	RF:10K~400MHz,1.6G~2.6GHz
IC7	FMC5	2 / 5	0.0V / 0.0V	RF:400M~1.6GHz
IC3	FMC5	2 / 5	+4.9V / +9.6V	RF:1G~1.6GHz
IC3	FMC5	2 / 5	0.0V / 0.0V	RF:10K~1GHz,1.6G~2.6GHz
IC4	FMC5	2 / 5	+4.9V / +9.6V	RF:10K~40MHz,1.6G~2.6GHz
IC4	FMC5	2 / 5	0.0V / 0.0V	RF:40M~1.6GHz
IC33	FMC5	2 / 5	+4.8V / +9.6V	AIP AMP (BUFF) ON , RF:10K~230MHz
IC33	FMC5	2 / 5	0.0V / 0.0V	AIP AMP (BUFF) OFF , RF:10K~230MHz
IC60	FMC5	2 / 5	+4.8V / +4.8V	BAND16 ON (RF:1G~1.6GHz) AMP2
IC60	FMC5	2 / 5	0.0V / 0.0V	BAND16 OFF (RF:1G~1.6GHz) AMP2
IC61	FMC5	2 / 5	+4.8V / +4.8V	BAND17 ON (RF:1.6G~2.6GHz) AMP2
IC61	FMC5	2 / 5	0.0V / 0.0V	BAND17 OFF (RF:1.6G~2.6GHz) AMP2
IC11	FMC5	2	+4.8V	BAND15 ON (RF:700M~1GHz)
IC11	FMC5	2	0.0V	BAND15 OFF (RF:700M~1GHz)
IC10	FMC5	2	+4.8V	BAND14 ON (RF:400M~700MHz)
IC10	FMC5	2	0.0V	BAND14 OFF (RF:400M~700MHz)
IC13	FMC5	2	+4.8V	BAND16,17 ON (RF:1G~2.6GHz)
IC13	FMC5	2	0.0V	BAND14,15 ON (RF:400M~1GHz)
IC13	FMC5	5	+9.8V	BAND16,17 ON (RF:1G~2.6GHz)
IC13	FMC5	5	0.0V	BAND14,15 ON (RF:400M~1GHz)
IC14	FMC5	2	+4.8V	BAND14,15 ON (RF:400M~1GHz) AMP3
IC14	FMC5	2	0.0V	BAND14,15 OFF (RF:400M~1GHz) AMP3
IC14	FMC5	5	+9.7V	BAND14,15 ON (RF:400M~1GHz) AMP3
IC14	FMC5	5	0.0V	BAND14,15 OFF (RF:400M~1GHz) AMP3
IC59	FMC5	2	+4.8V	LESS THAN RF:7MHz
IC59	FMC5	2	0.0V	MORE THAN RF:7MHz
IC59	FMC5	5	+9.7V	LESS THAN RF:7MHz
IC59	FMC5	5	0.0V	MORE THAN RF:7MHz
IC15	FMC5	2	+4.8V	BAND13 ON (RF:230M~400MHz)
IC15	FMC5	2	0.0V	BAND13 OFF (RF:230M~400MHz)
IC16	FMC5	2	+4.8V	BAND12 ON (RF:150M~230MHz)
IC16	FMC5	2	0.0V	BAND12 OFF (RF:150M~230MHz)
IC17	FMC5	2	+4.8V	BAND11 ON (RF:90M~150MHz)
IC17	FMC5	2	0.0V	BAND11 OFF (RF:90M~150MHz)
IC18	FMC5	2	+4.8V	BAND10 ON (RF:40M~90MHz)
IC18	FMC5	2	0.0V	BAND10 OFF (RF:40M~90MHz)
IC19	FMC5	2 / 5	+4.8V / +9.6V	AMP4 ON (BAND13:230M~400MHz)
IC19	FMC5	2 / 5	0.0V / 0.0V	AMP4 OFF (BAND13:230M~400MHz)
IC20	FMC5	2 / 5	+4.8V / +9.5V	AMP5 ON (BAND10,11,12)
IC20	FMC5	2 / 5	0.0V / 0.0V	AMP5 OFF (BAND10,11,12)
IC24	FMC5	2	+4.8V	BAND9 ON (RF:20M~40MHz)
IC24	FMC5	2	0.0V	BAND9 OFF (RF:20M~40MHz)
IC25	FMC5	2	+4.8V	BAND8 ON (RF:10M~20MHz)
IC25	FMC5	2	0.0V	BAND8 OFF (RF:10M~20MHz)
IC26	FMC5	2	+4.8V	BAND7 ON (RF:4M~10MHz)

AR5000 FRONT UNIT DC VOLTAGE

PARTS NO	NAME	PIN NO	LEVEL (V)	REMARKS
IC26	FMC5	2	0.0V	BAND7 OFF (RF:4M~10MHz)
IC27	FMC5	2	+4.8V	BAND6 ON (RF:2M~4MHz)
IC27	FMC5	2	0.0V	BAND6 OFF (RF:2M~4MHz)
IC28	FMC5	2	+4.8V	BAND5 ON (RF:900K~2MHz)
IC28	FMC5	2	0.0V	BAND5 OFF (RF:900K~2MHz)
IC29	FMC5	2	+4.8V	BAND4 ON (RF:500K~900KHz)
IC29	FMC5	2	0.0V	BAND4 OFF (RF:500K~900KHz)
IC32	FMC5	2 / 5	+4.8V / +9.6V	AMP6 ON (BAND1,4,5,6,7,8,9)
IC32	FMC5	2 / 5	0.0V / 0.0V	AMP6 OFF (BAND1,4,5,6,7,8,9)
IC53	FMC5	2	+4.4V	RF:10K~40MHz AMP ON / OFF
IC53	FMC5	2	0.0V	EXCEPT RF:10K~40MHz AMP ON / OFF
IC53	FMC5	1	+9.7V	RF:10K~1GHz ATT OFF ON
IC53	FMC5	1	0.0V	RF:10K~1GHz ATT OFF OFF
IC53	FMC5	5	+9.5V	RF:10K~40MHz ATT OFF ON
IC53	FMC5	5	0.0V	RF:10K~40MHz ATT OFF OFF
IC52	FMC5	2	+4.4V	RF:40M~400MHz AMP ON
IC52	FMC5	2	+4.4V	RF:40M~230MHz AMP OFF
IC52	FMC5	2	0.0V	EXCEPT RF:40M~400MHz AMP ON
IC52	FMC5	2	0.0V	EXCEPT RF:40M~230MHz AMP OFF
IC52	FMC5	1	+9.7V	RF:10K~1GHz ATT OFF ON
IC52	FMC5	1	0.0V	RF:10K~1GHz ATT OFF OFF
IC52	FMC5	5	+9.5V	RF:40M~400MHz ATT OFF ON
IC52	FMC5	5	0.0V	RF:40M~400MHz ATT OFF OFF
IC40	FMC5	2	+4.4V	RF:400M~1GHz AMP ON
IC40	FMC5	2	0.0V	EXCEPT RF:400M~1GHz AMP ON
IC40	FMC5	1	+9.7V	RF:10K~1GHz ATT OFF ON
IC40	FMC5	1	0.0V	RF:10K~1GHz ATT OFF OFF
IC40	FMC5	5	+9.5V	RF:400M~1GHz ATT OFF ON
IC40	FMC5	5	0.0V	RF:400M~1GHz ATT OFF OFF
IC39	FMC5	2	+4.4V	RF:10K~40MHz AMP ON / OFF
IC39	FMC5	2	0.0V	EXCEPT RF:10K~40MHz AMP ON / OFF
IC39	FMC5	1	+9.7V	RF:10K~1GHz ATT ON ON
IC39	FMC5	1	0.0V	RF:10K~1GHz ATT ON OFF
IC39	FMC5	5	+9.5V	RF:10K~40MHz ATT ON ON
IC39	FMC5	5	0.0V	RF:10K~40MHz ATT ON OFF
IC38	FMC5	2	+4.4V	RF:40M~400MHz AMP ON
IC38	FMC5	2	+4.4V	RF:40M~230MHz AMP OFF
IC38	FMC5	2	0.0V	EXCEPT RF:40M~400MHz AMP ON
IC38	FMC5	2	0.0V	EXCEPT RF:40M~230MHz AMP OFF
IC38	FMC5	1	+9.7V	RF:10K~1GHz ATT ON ON
IC38	FMC5	1	0.0V	RF:10K~1GHz ATT ON OFF
IC38	FMC5	5	+9.5V	RF:40M~400MHz ATT ON ON
IC38	FMC5	5	0.0V	RF:40M~400MHz ATT ON OFF
IC37	FMC5	2	+4.4V	RF:400M~1GHz AMP ON
IC37	FMC5	2	0.0V	EXCEPT RF:400M~1GHz AMP ON
IC37	FMC5	1	+9.7V	RF:10K~1GHz ATT ON ON
IC37	FMC5	1	0.0V	RF:10K~1GHz ATT ON OFF

AR5000 FRONT UNIT DC VOLTAGE

PARTS NO, NAME	PIN NO	LEVEL (V)	REMARKS
IC37 FMC5	5	+9.5V	RF:400M~1GHz ATT ON ON
IC37 FMC5	5	0.0V	RF:400M~1GHz ATT ON OFF

PARTS NO, NAME	BASE	COLLECTOR	EMITTER	REMARKS
Q46 DTC124EK	+4.8V	+0.1V	GND	AIP AMP (BUFF) ON , RF:10K~230MHz
Q46 DTC124EK	0.0V	+4.1V	GND	AIP AMP (BUFF) OFF , RF:10K~230MHz
Q45 2SC4536	+2.8V	+9.2V	+2.0V	AIP AMP (BUFF) BIAS VOLTAGE
Q50 DTC124EK	+4.8V	0.0V	GND	AIP AMP (BUFF) ON , RF:40M~230MHz
Q50 DTC124EK	0.0V	+10V	GND	AIP AMP (BUFF) OFF , RF:40M~230MHz
Q44 DTC124EK	+4.8V	0.0V	GND	AIP AMP (BUFF) ON , RF:10K~40MHz
Q44 DTC124EK	0.0V	+10V	GND	AIP AMP (BUFF) OFF , RF:10K~40MHz
Q52 DTC124EK	+4.8V	0.0V	GND	AMP2 , BAND16 ON (RF:1G~1.6GHz)
Q52 DTC124EK	0.0V	+9.4V	GND	AMP2 , BAND16 OFF (RF:1G~1.6GHz)
Q53 DTC124EK	+4.8V	0.0V	GND	AMP1 , BAND17 ON (RF:1G~1.6GHz)
Q53 DTC124EK	0.0V	+9.4V	GND	AMP1 , BAND17 OFF (RF:1G~1.6GHz)
Q5,7 DTC124EK	+4.8V	+ 0.1V	GND	BAND15 ON (RF:700M~1GHz)
Q5,7 DTC124EK	0.0V	+10V	GND	BAND15 OFF (RF:700M~1GHz)
Q6,8 DTC124EK	+4.8V	+ 0.1V	GND	BAND14 ON (RF:400M~700MHz)
Q6,8 DTC124EK	0.0V	+10V	GND	BAND14 OFF (RF:400M~700MHz)
Q11 DTC124EK	+4.3V	0.0V	GND	RF:400M~2.6GHz DBM2 ON
Q11 DTC124EK	0.0V	+10V	GND	RF:400M~2.6GHz DBM2 OFF
Q12 DTC124EK	+4.8V	0.0V	GND	RF:10K~400MHz DBM1 ON
Q12 DTC124EK	0.0V	+10V	GND	RF:10K~400MHz DBM1 OFF
Q15 DTC124EK	+4.8V	0.0V	GND	BAND13 ON (RF:230M~400MHz)
Q15 DTC124EK	0.0V	+9.4V	GND	BAND13 OFF (RF:230M~400MHz)
Q16,17 DTC124EK	+4.8V	+ 0.1V	GND	BAND12 ON (RF:150M~230MHz)
Q16,17 DTC124EK	0.0V	+9.4V	GND	BAND12 OFF (RF:150M~230MHz)
Q18,19 DTC124EK	+4.8V	+ 0.1V	GND	BAND11 ON (RF:90M~150MHz)
Q18,19 DTC124EK	0.0V	+9.4V	GND	BAND11 OFF (RF:90M~150MHz)
Q20,21 DTC124EK	+4.8V	+ 0.1V	GND	BAND10 ON (RF:40M~90MHz)
Q20,21 DTC124EK	0.0V	+9.4V	GND	BAND10 OFF (RF:40M~90MHz)
Q23 DTC124EK	+4.8V	0.0V	GND	AMP4 ON (BAND13:230M~400MHz)
Q23 DTC124EK	0.0V	+10V	GND	AMP4 OFF (BAND13:230M~400MHz)
Q22 2SC3357	+1.7V	+9.2V	+0.9V	AMP4 BIAS VOLTAGE
Q25,51 DTC124EK	+4.8V	0.0V	GND	AMP5 ON (RF:40M~230MHz)
Q25,51 DTC124EK	0.0V	+10V	GND	AMP5 OFF (RF:40M~230MHz)
Q24 2SC4536	+1.6V	+9.0V	+0.8V	AMP5 BIAS VOLTAGE
Q27,28 DTC124EK	+4.8V	0.1V	GND	BAND9 ON (RF:20M~40MHz)
Q27,28 DTC124EK	0.0V	+9.4V	GND	BAND9 OFF (RF:20M~40MHz)
Q29,30 DTC124EK	+4.8V	0.1V	GND	BAND8 ON (RF:10M~20MHz)
Q29,30 DTC124EK	0.0V	+9.4V	GND	BAND8 OFF (RF:10M~20MHz)
Q31,32 DTC124EK	+4.8V	0.1V	GND	BAND7 ON (RF:4M~10MHz)
Q31,32 DTC124EK	0.0V	+9.4V	GND	BAND7 OFF (RF:4M~10MHz)
Q33,34 DTC124EK	+4.8V	0.1V	GND	BAND6 ON (RF:2M~4MHz)
Q33,34 DTC124EK	0.0V	+9.4V	GND	BAND6 OFF (RF:2M~4MHz)
Q35,36 DTC124EK	+4.8V	0.1V	GND	BAND5 ON (RF:900K~2MMHz)
Q35,36 DTC124EK	0.0V	+9.4V	GND	BAND5 OFF (RF:900K~2MHz)

AR5000 FRONT UNIT DC VOLTAGE

PARTS	NO, NAME	BASE	COLLECTOR	EMITTER	REMARKS
Q37,38	DTC124EK	+4.8V	0.1V	GND	BAND4 ON (RF:500K~900KHz)
Q37,38	DTC124EK	0.0V	+9.4V	GND	BAND4 OFF (RF:500K~900KHz)
Q47,48	DTC124EK	+4.8V	0.1V	GND	BAND1 ON (RF:10K~500KHz)
Q47,48	DTC124EK	0.0V	+9.4V	GND	BAND1 OFF (RF:10K~500KHz)
Q41,43	DTC124EK	+4.8V	0.1V	GND	AMP6 ON (BAND1,4,5,6,7,8,9)
Q41,43	DTC124EK	0.0V	+10V	GND	AMP6 OFF (BAND1,4,5,6,7,8,9)
Q42	2SC4536	+1.6V	+9.2V	+0.8V	AMP6 BIAS VOLTAGE

PARTS	NO, NAME	GATE	DRAIN	SOURCE	REMARKS
Q10	FSX52WF	-1.4V	+9.23V	GND	AMP3 ON (BAND14,15)
Q10	FSX52WF	-1.4V	0.0V	GND	AMP3 OFF (BAND14,15)
Q13,14	3SK232	+3.67V (G2) +2.69V (G1)	+8.93V	+0.98V	AGC622 (AUDIO OUT : 12 SINAD) , BIAS VOLTAGE

PARTS	NO, NAME	ANODE	CATHODE		REMARKS
D1	1S2837	GND	+8.7V		ANT2 (M-TYPE)
D3	1S2837	GND	+8.7V		RF:10K~400MHz,1.6G~2.6GHz
D5	1S2837	GND	+8.7V		RF:1G~1.6GHz
D6	1S2837	GND	+8.7V		RF:10K~40MHz,1.6G~2.6GHz
D259	1SS269	+5.4V	+4.6V		RF:40M~230MHz AIP (BUFF) AMP ON
D232	1SS269	+5.4V	+4.6V		RF:10K~40MHz AIP (BUFF) AMP ON
D233	RN711H	+4.9V	+4.1V		RF:10K~230MHz AIP (BUFF) AMP ON
D260	RN711H	+5.7V	+4.9V		10K~230MHz AIP / 10K~40MHz AMP ON
D266	RN711H	+5.3V	+4.5V		ATT 0dB (RF:400M~1GHz)
D289	1SV196	+4.8V	+4.1V		ATT 10dB (RF:400M~1GHz)
D267	1SV196	+5.7V	+5.0V		ATT 10dB (RF:400M~1GHz)
D21	RN711H	+5.4V	+4.6V		BAND15 (RF:700M~1GHz)
D47	1SS269	+5.0V	+4.2V		BAND15 (RF:700M~1GHz)
D246	1SS269	+5.8V	+5.0V		BAND15 (RF:700M~1GHz)
D30	RN711H	+5.4V	+4.6V		BAND14 (RF:400M~700MHz)
D46	1SS269	+5.0V	+4.2V		BAND14 (RF:400M~700MHz)
D247	1SS269	+5.8V	+5.0V		BAND14 (RF:400M~700MHz)
D52	1SV196	+5.4V	+4.7V		1st LOCAL ON
D50	1SV196	+5.4V	+4.7V		1st IF ON
D51	1SV196	+5.4V	+4.7V		1st LOCAL ON
D54	1SV196	+5.4V	+4.7V		1st IF ON
D252	1SV196	+0.7V	GND		LESS THAN RF:7MHz
D277	RN711H	+6.8V	+6.0V		ATT 0dB (RF:40M~400MHz)
D276	1SV196	+6.1V	+6.0V		ATT 10dB (RF:40M~400MHz)
D278	1SV196	+7.2V	+6.4V		ATT 10dB (RF:40M~400MHz)
D56	1SV196	+5.4V	+4.6V		BAND13 (RF:230M~400MHz)
D65	1SV196	+5.4V	+4.6V		BAND12 (RF:150M~230MHz)
D74	1SS269	+5.4V	+4.6V		BAND12 (RF:150M~230MHz)
D75	1SV196	+5.4V	+4.6V		BAND11 (RF:90M~150MHz)
D84	1SS269	+5.4V	+4.6V		BAND11 (RF:90M~150MHz)
D85	1SV196	+5.4V	+4.6V		BAND10 (RF:40M~90MHz)
D102	1SS269	+5.4V	+4.6V		BAND10 (RF:40M~90MHz)

AR5000 FRONT UNIT DC VOLTAGE

PARTS NO, NAME	ANODE	CATHODE		REMARKS
D103 RN711H	+5.3V	+4.5V		AMP4 (RF:230M~400MHz)
D280 1SS269	+5.4V	+4.6V		AMP5 (RF:40M~230MHz)
D104 1SS269	+5.3V	+4.5V		AMP5 (RF:40M~230MHz)
D263 1SS143	+6.7V	+5.9V		ATT 0dB (RF:10K~40MHz)
D261 1SV196	+6.0V	+5.3V		ATT 10dB (RF:10K~40MHz)
D262 1SV196	+7.0V	+6.3V		ATT 10dB (RF:10K~40MHz)
D106 1SS143	+4.3V	+3.6V		BAND9 (RF:20M~40MHz)
D117 1SS269	+5.4V	+4.6V		BAND9 (RF:20M~40MHz)
D118 1SS143	+4.3V	+3.6V		BAND8 (RF:10M~20MHz)
D243 1SS269	+5.4V	+4.6V		BAND8 (RF:10M~20MHz)
D138 1SS143	+4.3V	+3.6V		BAND7 (RF:4M~10MHz)
D151 1SS269	+5.4V	+4.6V		BAND7 (RF:4M~10MHz)
D152 1SS143	+4.3V	+3.6V		BAND6 (RF:2M~4MHz)
D166 1SS269	+5.4V	+4.6V		BAND6 (RF:2M~4MHz)
D167 1SS143	+4.3V	+3.6V		BAND5 (RF:900K~2MHz)
D181 1SS269	+5.4V	+4.6V		BAND5 (RF:900K~2MHz)
D182 1SS143	+4.3V	+3.6V		BAND4 (RF:500K~900KHz)
D200 1SS269	+5.4V	+4.6V		BAND4 (RF:500K~900KHz)
D239 1SS143	+4.3V	+3.6V		BAND1 (RF:10K~500KHz)
D240 1SS269	+5.4V	+4.6V		BAND1 (RF:10K~500KHz)
D230 1SS269	+5.4V	+4.6V		AMP6 (RF:10K~40MHz)
D231 1SS269	+4.9V	+4.1V		AMP6 (RF:10K~40MHz)
D242 1S2837	+4.9V (1)	+4.4V		RF:10K~40MHz AMP ON
	+4.9V (2)			RF:10K~40MHz AMP OFF (AIP ON)
D241 1S2837	+4.9V (1)	+4.4V		RF:230M~400MHz AMP ON
	+4.9V (2)			RF:40M~230MHz AMP ON
D275 1S2837	+4.9V (1)	+4.4V		RF:40M~230MHz AMP OFF (AIP ON)
D238 1S2837	+4.9V (2)	+4.4V		RF:400M~1GHz AMP ON

AR5000 PLL UNIT DC VOLTAGE

PARTS NO,	NAME	PIN NO	LEVEL (V)	REMARKS
IC1	MB1501	5 / 7	+1.6V / +4.1V	WHEN PLL LOCKED
IC1	MB1501	5 / 7	0.0V / 0.0V	WHEN PLL UNLOCKED
IC3	MB1504	5 / 7	+1.6V / +3.9V	WHEN PLL LOCKED
IC3	MB1504	5 / 7	0.0V / 0.0V	WHEN PLL UNLOCKED
IC2	TC4581F	2 / 3 / 5	+4.0V / +4.1V / +4.9V	WHEN PLL LOCKED
IC16	S-8054HN	2 / 3	+4.9V / +4.9V	RESET FOR NCO
IC6	UPC2709T	4 / 6	+5.3V / +5.3V	AMP FOR 2nd LOCAL (Fc=680MH LPF)
IC7	UPC1675G	3	+5.7V	AMP FOR 2nd LOCAL (Fc=680MH LPF)
IC9	UPC2709T	4 / 6	+5.5V / +5.5V	AMP FOR 1st LOCAL (Fc=1GHz LPF)
IC12	UPC2709T	4 / 6	+4.6V / +4.6V	AMP FOR 1st LOCAL (Fc=1.4GHz LPF)
IC14	UPC2709T	4 / 6	+4.6V / +4.6V	AMP FOR 1st LOCAL (Fc=1GHz LPF)
IC11	UPC2709T	4 / 6	+4.7V / +4.7V	AMP FOR 1st LOCAL (Fc=1.5GHz BPF)
IC13	UPC2709T	4 / 6	+4.7V / +4.7V	AMP FOR 1st LOCAL (Fc=1.1GHz BPF)
IC10	UPC1675G	3	+5.5V	AMP FOR 1st LOCAL LOOP (Fc=1.3GHz LPF)
IC18	UPD4017BG	15	+4.9V	SUBCARRIER OFF
IC18	UPD4017BG	15	0.0V	SUBCARRIER ON
Q23	FMC5	2 / 5	+4.8V / +5.8V	AMP ON FOR 1st LOCAL (Fc=1GHz LPF)
Q23	FMC5	2 / 5	0.0V / 0.0V	AMP OFF FOR 1st LOCAL (Fc=1GHz LPF)
Q24	FMC5	2 / 5	+4.8V / +5.8V	AMP ON FOR 1st LOCAL (Fc=1.4GHz LPF)
Q24	FMC5	2 / 5	0.0V / 0.0V	AMP OFF FOR 1st LOCAL (Fc=1.4GHz LPF)
Q25	FMC5	2 / 5	+4.8V / +5.8V	AMP ON FOR 1st LOCAL (Fc=1GHz LPF)
Q25	FMC5	2 / 5	0.0V / 0.0V	AMP OFF FOR 1st LOCAL (Fc=1GHz LPF)
Q26	FMC5	2 / 5	+4.8V / +5.8V	AMP ON FOR 1st LOCAL (Fc=1.5GHz BPF)
Q26	FMC5	2 / 5	0.0V / 0.0V	AMP OFF FOR 1st LOCAL (Fc=1.5GHz BPF)
Q27	FMC5	2 / 5	+4.8V / +5.8V	AMP ON FOR 1st LOCAL (Fc=1.1GHz BPF)
Q27	FMC5	2 / 5	0.0V / 0.0V	AMP OFF FOR 1st LOCAL (Fc=1.1GHz BPF)
Q33	FMC5	2 / 5	+4.8V / +9.1V	VCO (10K~30MHz) ON
Q33	FMC5	2 / 5	0.0V / 0.0V	VCO (10K~30MHz) OFF
Q18	FMC5	2 / 5	+4.8V / +9.1V	VCO (30M~175M,675M~975M,1400M~1425M, 1925M~2225MHz) ON
Q18	FMC5	2 / 5	0.0V / 0.0V	VCO (30M~175M,675M~975M,1400M~1425M, 1925M~2225MHz) OFF
Q19	FMC5	2 / 5	+4.8V / +9.1V	VCO (175M~340M,975M~1385M,1425M~1590 M,2225M~2600MHz) ON
Q19	FMC5	2 / 5	0.0V / 0.0V	VCO (175M~340M,975M~1385M,1425M~1590 M,2225M~2600MHz) OFF
Q20	FMC5	2 / 5	+4.8V / +9.1V	VCO (340M~500M,1385M~1400M,1590M~ 1750MHz) ON
Q20	FMC5	2 / 5	0.0V / 0.0V	VCO (340M~500M,1385M~1400M,1590M~ 1750MHz) OFF
Q21	FMC5	2 / 5	+4.8V / +9.1V	VCO (500M~675M,1750M~1925MHz) ON
Q21	FMC5	2 / 5	0.0V / 0.0V	VCO (500M~675M,1750M~1925MHz) OFF
Q40	FMC5	2 / 5	+4.2V / +4.9V	INTERNAL OSC 12.8MHz ON
Q40	FMC5	2 / 5	0.0V / 0.0V	EXTERNAL OSC 10.0MHz ON

AR5000 PLL UNIT DC VOLTAGE

PARTS	NO, NAME	BASE	COLLECTOR	EMITTER	REMARKS
Q15	2SC1623	+8.3V	+10V	+7.9V	DC POWER SUPPLY +10V TO +7.7V
Q4	2SC1623	+4.8V	+5.0V	+4.1V	DC POWER SUPPLY +5.0V TO +4.3V
Q16	2SC1623	+8.3V	+10V	+7.7V	DC POWER SUPPLY +10V TO +7.7V
Q17	2SC1623	+4.9V	+5.0V	+4.2V	DC POWER SUPPLY +5.0V TO +4.3V
Q1	2SC1623	0.0V	+4.1V	GND	WHEN PLL LOCKED
Q1	2SC1623	+0.6V	0.1V	GND	WHEN PLL UNLOCKED
Q3	2SA812	+4.1V	0.0V	+4.1V	WHEN PLL LOCKED
Q3	2SA812	+3.5V	+4.0V	+4.1V	WHEN PLL UNLOCKED
Q22	2SC1623	+30.4V	+30.6V	+29.8V	DC POWER SUPPLY +30V TO +28V
Q10	2SC1623	----	+14.7V	GND	WHEN PLL LOCKED
Q2	2SC1623	0.0V	+4.0V	GND	WHEN PLL LOCKED
Q2	2SC1623	+0.6V	0.1V	GND	WHEN PLL UNLOCKED
Q7	2SA812	+3.8V	0.0V	+4.0V	WHEN PLL LOCKED
Q7	2SA812	+3.4V	+3.9V	+4.0V	WHEN PLL UNLOCKED
Q6	2SC1623	+5.6V	+10V	+5.0V	DC POWER SUPPLY +10V TO +6.3V
Q9	2SC1623	----	+3.2V	GND	WHEN PLL LOCKED
Q5	2SC1623	+9.98V	+10V	+9.33V	DC POWER SUPPLY +10V TO +9.0V
Q28	DTC124EK	+4.8V	+0.1V	GND	1st LOCAL (Fc=1GHz LPF) ON
Q28	DTC124EK	0.0V	+9.8V	GND	1st LOCAL (Fc=1GHz LPF) OFF
Q29	DTC124EK	+4.8V	+0.1V	GND	1st LOCAL (Fc=1.4GHz LPF) ON
Q29	DTC124EK	0.0V	+9.8V	GND	1st LOCAL (Fc=1.4GHz LPF) OFF
Q30	DTC124EK	+4.8V	+0.1V	GND	1st LOCAL (Fc=1GHz LPF) ON
Q30	DTC124EK	0.0V	+9.8V	GND	1st LOCAL (Fc=1GHz LPF) OFF
Q31	DTC124EK	+4.8V	+0.1V	GND	1st LOCAL (Fc=1.5GHz BPF) ON
Q31	DTC124EK	0.0V	+9.8V	GND	1st LOCAL (Fc=1.5GHz BPF) OFF
Q32	DTC124EK	+4.8V	+0.1V	GND	1st LOCAL (Fc=1.1GHz BPF) ON
Q32	DTC124EK	0.0V	+9.8V	GND	1st LOCAL (Fc=1.1GHz BPF) OFF
Q34	2SC1623	+8.3V	+10V	+7.9V	DC POWER SUPPLY +10V TO +7.7V
Q35	2SC1623	+4.9V	+5.0V	+4.2V	DC POWER SUPPLY +5.0V TO +4.3V
Q37	DTC124EK	0.0V	+4.9V	GND	SUBCARRIER OFF
Q37	DTC124EK	+4.8V	0.0V	GND	SUBCARRIER ON
Q36	2SC1009A	+2.3V	+9.9V	+1.6V	SUBCARRIER BUFFER AMP (FM MODE)
Q39	2SC1009A	+5.1V	+8.2V	+4.4V	SUBCARRIER PLL OSC (CW MODE)
Q38	2SC3356	+2.3V	+4.4V	+1.6V	SUBCARRIER PLL OSC (CW MODE)
Q14	2SC1623	+9.9V	+10V	+9.2V	DC POWER SUPPLY +10V TO +9.0V
Q41	DTC124EK	+4.2V	0.0V	GND	INTERNAL OSC 12.8MHz ON
Q43	DTC323TK	+4.2V	0.0V	GND	INTERNAL OSC 12.8MHz ON
Q41	DTC124EK	0.0V	+10V	GND	INTERNAL OSC 12.8MHz OFF
Q43	DTC323TK	0.0V	OPEN	GND	INTERNAL OSC 12.8MHz OFF
Q42	DTC124EK	+4.8V	0.0V	GND	EXTERNAL OSC 10.0MHz ON
Q42	DTC124EK	0.0V	+10V	GND	EXTERNAL OSC 10.0MHz OFF
Q44	2SC2759	+0.7V	+4.4V	GND	AMP FOR INTERNAL OSC 12.8MHz

AR5000 PLL UNIT DC VOLTAGE

PARTS NO, NAME	ANODE	CATHODE	REMARKS
D14,12 RN711H	+5.3V	+4.5V	1st LOCAL (Fc=1GHz LPF) ON
D15,11 RN711H	+5.3V	+4.5V	1st LOCAL (Fc=1.4GHz LPF) ON
D16 RN711H	+5.3V	+4.5V	1st LOCAL (Fc=1GHz LPF) ON
D17,10 RN711H	+5.3V	+4.5V	1st LOCAL (Fc=1.5GHz BPF) ON
D18,13 RN711H	+5.3V	+4.5V	1st LOCAL (Fc=1.1GHz BPF) ON
D23 1SV166	GND	+3.12V	SUBCARRIER PLL OSC (CW MODE)
	GND	+2.83V	SUBCARRIER PLL OSC (LSB MODE)
	GND	+4.95V	SUBCARRIER PLL OSC (USB MODE)
CW PITCH : 1KHz CHECK POINT : C195---R106			
D20 1SV196	+4.7V	+4.2V	VCO 1 (NIS--151) RF OUT 1
D3 1SV196	+4.9V	+4.2V	VCO 2 (NIS--152) RF OUT 2
D1 1SV196	+4.9V	+4.2V	VCO 2 (NIS--152) RF OUT 3
D2 1SV196	+4.9V	+4.2V	VCO 3 (NIS--153) RF OUT 4
D4 1SV196	+4.9V	+4.2V	VCO 3 (NIS--153) RF OUT 5
D24 1SV196	+5.4V	+4.7V	INTERNAL OSC 12.8MHz OUT
D25 1SV196	+5.4V	+4.7V	EXTERNAL OSC 10.0MHz OUT

AR5000 IF UNIT DC VOLTAGE

PARTS NO, NAME	PIN NO	LEVEL (V)	REMARKS
Q16 FMC5	2 / 5	+4.4V / +10V	AMP ON (IF:10.7MHz,BW:30K,110K,220KHz)
Q16 FMC5	2 / 5	0.0V / 0.0V	AMP OFF (IF:10.7MHz,BW:30K,110K,220KHz)
Q17 FMC5	2 / 5	+4.4V / +10V	AMP ON FOR EXTERNAL IF2 : 10.7MHz
Q17 FMC5	2 / 5	0.0V / 0.0V	AMP OFF FOR EXTERNAL IF2 : 10.7MHz
Q18 FMC5	2 / 5	+4.4V / +10V	AMP ON FOR EXTERNAL IF1 : 10.7MHz
Q18 FMC5	2 / 5	0.0V / 0.0V	AMP OFF FOR EXTERNAL IF1 : 10.7MHz
IC8 MC3372M	16	+1.73V	RX OFF (AGC455 TP5 : +4.5V)
Q19 FMC5	2 / 5	+4.9V / +10V	FM DEVIATION ON : 7K,25K,50KHz
Q19 FMC5	2 / 5	0.0V / 0.0V	FM DEVIATION OFF : 7K,25K,50KHz
Q23 FMC5	1 / 2 / 5	+7.7V / +4.9V / +7.7V	FM DEVIATION ON : 3.5KHz
Q23 FMC5	2 / 5	+10V / 0.0V / 0.0V	FM DEVIATION OFF : 3.5KHz
Q24 FMC5	1 / 2 / 5	+7.7V / +4.4V / +7.7V	FM DEVIATION ON : 1.75KHz , CW ON
Q24 FMC5	1 / 2 / 5	+10V / 0.0V / 0.0V	FM DEVIATION OFF : 1.75KHz , CW OFF
IC10B UPC358G	5 / 7	+5.1V / +5.1V	EXTERNAL MUTE OFF
IC10A UPC358G	1 / 3	+5.1V / +5.1V	RX OFF
IC20A UPC358G	1 / 2 / 3	+3.9V / +2.5V / +2.5V	SQUELCH VOLUME FULL LEFT SPIN
IC20A UPC358G	1 / 2 / 3	+50mV / +2.3V / +2.2V	RX OFF
IC22A UPC358G	1 / 2 / 3	+1.2V / +2.2V / +2.2V	RX : 128.9MHz , -30dBm
IC22B UPC358G	5 / 7	+4.4V / +4.4V	VR4 : TP8
IC23A UPC358G	1 / 3	+0.32V / +0.32V	LEVEL SQUELCH : 60
IC23A UPC358G	1 / 3	+1.36V / +1.36V	RX : 128.9MHz , -108dBm , RF GAIN
IC23B UPC358G	5 / 6 / 7	+1.15V / +1.15V / +4.91V	RX : 128.9MHz , -108dBm , RF GAIN
IC23B UPC358G	5 / 6 / 7	+0.99V / +0.99V / +4.23V	RX : 128.9MHz , -30dBm

PARTS NO, NAME	BASE	COLLECTOR	EMITTER	REMARKS
Q9 DTC124EK	+4.4V	0.0V	GND	BPF ON (IF:10.7MHz , BW : 0.5K,3KHz)
Q9 DTC124EK	0.0V	+10V	GND	BPF OFF (IF:10.7MHz , BW : 0.5K,3KHz)
Q10 DTC124EK	+4.9V	0.0V	GND	BPF ON (IF:10.7MHz , BW : 6KHz)
Q10 DTC124EK	0.0V	+10V	GND	BPF OFF (IF:10.7MHz , BW : 6KHz)
Q11 DTC124EK	+4.9V	0.0V	GND	BPF ON (IF:10.7MHz , BW : 15KHz)
Q11 DTC124EK	0.0V	+10V	GND	BPF OFF (IF:10.7MHz , BW : 15KHz)
Q12 DTC124EK	+4.9V	0.0V	GND	BPF ON (IF:10.7MHz , BW : 30KHz)
Q12 DTC124EK	0.0V	+10V	GND	BPF OFF (IF:10.7MHz , BW : 30KHz)
Q13 DTC124EK	+4.9V	0.0V	GND	BPF ON (IF:10.7MHz , BW : 110KHz)
Q13 DTC124EK	0.0V	+10V	GND	BPF OFF (IF:10.7MHz ; BW : 110KHz)
Q14 DTC124EK	+4.9V	0.0V	GND	BPF ON (IF:10.7MHz , BW : 220KHz)
Q14 DTC124EK	0.0V	+10V	GND	BPF OFF (IF:10.7MHz , BW : 220KHz)
Q15 DTC124EK	+4.4V	0.0V	GND	AMP ON (IF:10.7MHz,BW:30K,110K,220KHz)
Q15 DTC124EK	0.0V	+10V	GND	AMP OFF (IF:10.7MHz,BW:30K,110K,220KHz)
Q20 DTC124EK	+4.9V	C---E SHORT	GND	FM DEVIATION ON : 50KHz
Q20 DTC124EK	0.0V	OPEN	GND	FM DEVIATION OFF : 50KHz
Q21 DTC124EK	+4.9V	C---E SHORT	GND	FM DEVIATION ON : 25KHz
Q21 DTC124EK	0.0V	OPEN	GND	FM DEVIATION OFF : 25KHz
Q22 DTC124EK	+4.9V	C---E SHORT	GND	FM DEVIATION ON : 7KHz
Q22 DTC124EK	0.0V	OPEN	GND	FM DEVIATION OFF : 7KHz

AR5000 IF UNIT DC VOLTAGE

PARTS NO, NAME	BASE	COLLECTOR	EMITTER	REMARKS
Q28 2SC1623	+2.44V	+4.17V	+1.81V	SUBCARRIER (SSB,CW) DETECTOR
Q29 2SC1009A	+3.51V	+7.23V	+2.79V	BUFFER AMP (IF:455KHz)
Q32 2SC1623	+5.09V	+9.74V	+4.51V	AGC (RX OFF)
Q31 2SC1623	+0.42V	+3.71V	GND	AGC (RX : 128.9MHz , -30dBm)
Q31 2SC1623	+0.35V	+4.76V	GND	AGC (RX : 128.9MHz , -108dBm)
Q30 DTC124EK	+4.9V	C---E SHORT	GND	AGC OFF
Q30 DTC124EK	0.0V	OPEN	GND	AGC ON
Q33 DTC124EK	+4.9V	0.0V	GND	BPF ON (IF:455KHz , BW : 0.5KHz)
Q33 DTC124EK	0.0V	+10V	GND	BPF OFF (IF:455KHz , BW : 0.5KHz)
Q34 DTC124EK	+4.9V	0.0V	GND	BPF ON (IF:455KHz , BW : 3KHz)
Q34 DTC124EK	0.0V	+10V	GND	BPF OFF (IF:455KHz , BW : 3KHz)
Q35 DTC124EK	+4.9V	0.0V	GND	BPF ON (IF:455KHz , BW : 6KHz)
Q35 DTC124EK	0.0V	+10V	GND	BPF OFF (IF:455KHz , BW : 6KHz)
Q36 DTC124EK	+4.9V	0.0V	GND	BPF ON (IF:455KHz , BW : 15KHz)
Q36 DTC124EK	0.0V	+10V	GND	BPF OFF (IF:455KHz , BW : 15KHz)
Q37 DTC124EK	+4.9V	0.0V	GND	BPF ON (IF:455KHz , BW : 30KHz)
Q37 DTC124EK	0.0V	+10V	GND	BPF OFF (IF:455KHz , BW : 30KHz)
Q38 DTC124EK	+4.9V	0.0V	GND	BPF ON (IF:455KHz , BW : 110KHz)
Q38 DTC124EK	0.0V	+10V	GND	BPF OFF (IF:455KHz , BW : 110KHz)
Q39 DTC124EK	+4.9V	0.0V	GND	BPF ON (IF:455KHz , BW : 220KHz)
Q39 DTC124EK	0.0V	+10V	GND	BPF OFF (IF:455KHz , BW : 220KHz)

PARTS NO, NAME	GATE	DRAIN	SOURCE	REMARKS
Q3 2SK520	0.0V	+8.96V	+2.22V	BUFFER AMP (IF:10.7MHz)
Q5 3SK131	+4.0V (2) +2.07V (1)	+9.55V	+2.35V	AMP (IF:10.7MHz) RX : OFF
Q4 3SK131	+4.0V (2) +2.47V (1)	+8.74V	+2.46V	AMP FOR BPF (IF:10.7MHz) RX : OFF
Q6 3SK131	+4.0V (2) +1.06V (1)	+9.99V	+1.34V	AMP FOR BPF (IF:10.7MHz , BW : 30K, 110K,220KHz) RX : OFF
Q7 3SK131	+4.0V (2) +2.48V (1)	+8.89V	+2.47V	AMP (IF:10.7MHz MAIN) RX : OFF
Q8 3SK131	+4.0V (2) +2.71V (1)	+9.11V	+2.78V	AMP (IF:10.7MHz EXTERNAL) RX : OFF
Q25,26 3SK131	+4.5V (2) +2.43V (1)	+7.45V	+2.47V	AMP (IF:455KHz) RX : OFF
Q27 3SK131	+4.5V (2) +2.04V (1)	+7.8V	+2.15V	AMP (IF:455KHz) RX : OFF

PARTS NO, NAME	ANODE	CATHODE		REMARKS
D1 RN711H	+3.9V	+3.2V		BPF (IF:10.7MHz , BW : 0.5K,3KHz)
D2 RN711H	+5.8V	+5.1V		BPF (IF:10.7MHz , BW : 6KHz)
D3 RN711H	+5.1V	+4.4V		BPF (IF:10.7MHz , BW : 15KHz)
D4 RN711H	+5.8V	+5.1V		BPF (IF:10.7MHz , BW : 30KHz)
D5 RN711H	+5.1V	+4.4V		BPF (IF:10.7MHz , BW : 110KHz)
D6 RN711H	+5.1V	+4.4V		BPF (IF:10.7MHz , BW : 220KHz)
D10 RN711H	+4.0V	+3.3V		BPF (IF:10.7MHz , BW : 0.5K,3KHz)

AR5000 IF UNIT DC VOLTAGE

PARTS NO, NAME	ANODE	CATHODE		REMARKS
D11 RN711H	+4.8V	+4.0V		BPF (IF:10.7MHz , BW : 6KHz)
D12 1SV196	+7.1V	+6.5V		BPF (IF:10.7MHz , BW : 15KHz)
D7 1SV196	+4.6V	+4.0V		BPF (IF:10.7MHz , BW : 30KHz)
D8 1SV196	+2.8V	+2.1V		BPF (IF:10.7MHz , BW : 110KHz)
D9 1SV196	+3.5V	+2.9V		BPF (IF:10.7MHz , BW : 220KHz)
D13 RN711H	+5.4V	+4.7V		BPF (IF:10.7MHz , BW : 30K,110K,220KHz)
D14 RN711H	+5.4V	+4.6V		EXTERNAL IF2 : 10.7MHz
D15 RN711H	+5.4V	+4.6V		EXTERNAL IF1 : 10.7MHz
D16 1S2837	+4.9V (1,2)	+4.4V		BPF (IF:10.7MHz , BW : 0.5K,3KHz)
D17 HN2D01F	+4.9V (4,5,6)	+4.4V (1,2,3,		BPF (IF:10.7MHz , BW : 30K,110K,220KHz)
D20 1S2837	+1.73V (1)	+1.58V		AGC455 : +4.5V (TP5) RX : OFF
D24 ND411G-1	----	+0.42V (1)		AGC (RX : 128.9MHz , -30dBm)
D24 ND411G-1	----	+0.35V (1)		AGC (RX : 128.9MHz , -108dBm)
D25 ND411G-1	+0.69V (2)	+0.59V (3)		AM DETECTOR , RX : OFF
		+0.51V (1)		
D21 1SS268	+9.14V (1)	+8.41V (3)		FM DEVIATION ON : 7K,25K,50KHz
	+6.91V (2)	+6.16V (3)		FM DEVIATION ON : 3.5KHz
	+6.16V (2)	+5.42V (3)		FM DEVIATION ON : 1.75KHz , CW ON
D22 HN2D01F	+4.9V (4,5,6)	+4.4V (1,2,3)		FM DEVIATION ON : 1.75KHz , CW ON
D26 RN711H	+5.6V	+4.9V		BPF (IF : 455KHz , BW : 0.5KHz)
D27 RN711H	+5.0V	+4.3V		BPF (IF : 455KHz , BW : 0.5KHz)
D28 RN711H	+5.6V	+4.9V		BPF (IF : 455KHz , BW : 3KHz)
D29 RN711H	+5.5V	+4.8V		BPF (IF : 455KHz , BW : 3KHz)
D30 RN711H	+5.6V	+4.9V		BPF (IF : 455KHz , BW : 6KHz)
D31 RN711H	+3.9V	+3.2V		BPF (IF : 455KHz , BW : 6KHz)
D32 RN711H	+4.1V	+3.3V		BPF (IF : 455KHz , BW : 15KHz)
D33 RN711H	+4.8V	+4.0V		BPF (IF : 455KHz , BW : 15KHz)
D34 RN711H	+4.9V	+4.2V		BPF (IF : 455KHz , BW : 30KHz)
D35 RN711H	+4.3V	+3.6V		BPF (IF : 455KHz , BW : 30KHz)
D36 RN711H	+4.9V	+4.2V		BPF (IF : 455KHz , BW : 110KHz)
D37 RN711H	+3.2V	+2.5V		BPF (IF : 455KHz , BW : 110KHz)
D38 RN711H	+4.1V	+3.4V		BPF (IF : 455KHz , BW : 220KHz)
D39 RN711H	+2.9V	+2.2V		BPF (IF : 455KHz , BW : 220KHz)
D41 RB500H	+1.34V	+1.15V		RX : 128.9MHz , -108dBm , RF GAIN
D41 RB500H	+1.18V	+0.99V		RX : 128.9MHz , -30dBm

AR5000 AUDIO POWER UNIT DC VOLTAGE

PARTS NO, NAME	PIN NO	LEVEL (V)	REMARKS
IC12 LC73881M	2	+4.8V	DTMF OFF
IC12 LC73881M	2	+0.0V	DTMF ON
IC1 TC4W53F	5	+4.9V	RMT ON OR ALM ON (AUDIO CHOICE)
IC1 TC4W53F	5	0.0V	RMT OFF OR ALM OFF (BEEP CHOICE)
IC3 TC4W53F	5	+4.9V	RMT ON OR ALM ON (E-VR CHOICE)
IC3 TC4W53F	5	0.0V	RMT OFF OR ALM OFF (M-VR CHOICE)
IC6 TC4SU69F	2 / 5	+4.9V / 0.0V	WHEN PLL LOCKED
IC6 TC4SU69F	2 / 5	0.0V / +4.9V	WHEN PLL UNLOCKED
IC13 TC4581F	2 / 3 / 5	0.0V / 0.0V / 0.0V	WHEN PLL LOCKED , MUTE OFF
IC13 TC4581F	2 / 3 / 5	+4.5V / +4.5V / +4.8V	PLL UNLOCKED OR MUTE ON
Q5 FMC5	2 / 5	+4.1V / +10V	WHEN PLL LOCKED, MUTE OFF : E-SW ON
Q5 FMC5	2 / 5	0.0V / OPEN	PLL UNLOCKED OR MUTE ON : E-SW OFF
IC8 PFA113AL	1 / 4 / 5	+1.1V / 4---5 SHORT	WHEN PLL LOCKED, MUTE OFF : E-SW ON
IC8 PFA113AL	1 / 4 / 5	OPEN / 4---5 OPEN	PLL UNLOCKED OR MUTE ON : E-SW OFF
IC9B UPC358G	5 / 7	+3.8V / +3.8V	RX : 128.9MHz , -50dBm

PARTS NO, NAME	BASE	COLLECTOR	EMITTER	REMARKS
Q8 DTC124TK	0.0V	+4.1V	GND	WHEN PLL LOCKED, MUTE OFF: E-SW ON
Q8 DTC124TK	+4.8V	0.0V	GND	PLL UNLOCKED OR MUTE ON : E-SW OFF

PARTS NO, NAME	GATE	DRAIN	SOURCE	REMARKS
Q2 2SK160	0.0V	+4.57V	+0.38V	AUDIO BUFFER AMP
Q1 2SK680	0.0V	OPEN	GND	WHEN PLL LOCKED , MUTE OFF : AUDIO OUTPUT ON
Q1 2SK680	+4.8V	1---2 SHORT	GND	PLL UNLOCKED OR MUTE ON : AUDIO OUTPUT OFF

PARTS NO, NAME	ANODE	CATHODE		REMARKS
D1 1S2837	0.0V (1) 0.0V (2)	0.0V		WHEN PLL LOCKED , MUTE OFF
D1 1S2837	0.0V (1) +4.9V (2)	+4.5V		WHEN PLL LOCKED , MUTE ON
D1 1S2837	+4.9V (1) 0.0V (2)	+4.5V		WHEN PLL UNLOCKED , MUTE OFF
D1 1S2837	+4.9V (1) +4.9V (2)	+4.5V		WHEN PLL UNLOCKED , MUTE ON

AR5000 POWER UNIT DC VOLTAGE

PARTS NO, NAME	PIN NO	LEVEL (V)	REMARKS
IC2 KPL108	1 / 3	+11.6V / -8.1V	+12V TO -8V DC / DC CONVERTER
IC6 TA79L05F	2 / 1	-8.0V / -5.0V	-5V VOLTAGE REGULATOR
IC3 KPL130	1 / 3	+11.5V / +30.7V	+12V TO +30V DC / DC CONVERTER
IC4 S-81252PG	2 / 1	+11.7V / +5.2V	+5.2V VOLTAGE REGULATOR (FOR CPU)
IC1 S-8054HN	2 / 3	+7.8V / +3.6V (OPEN)	+3.8V~+4.2V VOLTAGE DETECTOR
IC1 S-8054HN	2 / 3	+3.8V~+4.2V / 0.0V	+3.8V~+4.2V VOLTAGE DETECTOR
IC5 S-81252PG	2 / 1	+11.7V / +5.2V	+5.2V VOLTAGE REGULATOR

PARTS NO, NAME	BASE	COLLECTOR	EMITTER	REMARKS
Q3 2SB624	+10.9V	+11.6V	+11.6V	
Q2 DTC124EK	+4.9V	0.0V	GND	DC POWER ON (FROM CPU)
Q2 DTC124EK	0.0V	+11.5V	GND	DC POWER OFF (FROM CPU)

PARTS NO, NAME	GATE	DRAIN	SOURCE	REMARKS
Q1 2SJ330	0.0V	+11.6V	+11.7V	DC POWER ON (FROM CPU)
Q1 2SJ330	+11.7V	OPEN	+11.7V	DC POWER OFF (FROM CPU)

PARTS NO, NAME	ANODE	CATHODE		REMARKS
D1 1S2837	+5.2V	+4.7V		A/D CONV REF VOLTAGE (FOR CPU)
D2 3GWJ42	+12V	+11.7V		PROTECTION DIODE FOR -12V SUPPLY

AR5000 FRONT UNIT RF / IF (10.7MHz , 622.4MHz) LEVEL

OUTPUT CONDITIONS : 12 SINAD (AUDIO LEVEL) , RX : AM (60 % ,BW:6KHz) ,FM (3.5KHz,BW:15KHz)

PARTS NO, NAME	CHECK POINT	LEVEL (dBm)	INSPECTION ITEMS
K1 RK1-9V	14:INPUT	-109dBm	BAND1 (10K~500KHz) RX : 250KHz (AM)
D230 1SS269	ANODE	-108dBm	
K1 RK1-9V	14:INPUT	-108dBm	BAND6 (2M~4MHz) RX : 3MHz (AM)
D230 1SS269	ANODE	-110dBm	
K1 RK1-9V	14:INPUT	-98dBm	BAND9 (20M~40MHz) RX : 30MHz (AM)
D230 1SS269	ANODE	-108dBm	
K1 RK1-9V	14:INPUT	-116dBm	BAND10 (40M~90MHz) RX : 57.5MHz (FM)
D280 1SS269	ANODE	-117dBm	
K1 RK1-9V	14:INPUT	-117dBm	BAND11 (90M~150MHz) RX : 112.5MHz (FM)
D280 1SS269	ANODE	-117dBm	
K1 RK1-9V	14:INPUT	-116dBm	BAND12 (150M~230MHz) RX : 190MHz (FM)
D280 1SS269	ANODE	-110dBm	
K1 RK1-9V	14:INPUT	-116dBm	BAND13 (230M~400MHz) RX : 315MHz (FM)
D62 1SV163	ANODE	-118dBm	
K1 RK1-9V	14:INPUT	-117dBm	BAND14 (400M~700MHz) RX : 550MHz (FM)
D246 1SS269	ANODE	-120dBm	
K1 RK1-9V	14:INPUT	-117dBm	BAND15 (700M~1GHz) RX : 850MHz (FM)
D246 1SS269	ANODE	-121dBm	
K1 RK1-9V	14:INPUT	-120dBm	BAND16 (1G~1.6GHz) RX : 1.3GHz (FM)
DBM2 5MXB25-75	1	-87dBm	AMP2 (1G~1.6GHz)
D230 1SS269	ANODE	-108dBm	AMP6 (10K~40MHz) RX : 250KHz (AM)
D232 1SS269	ANODE	-98dBm	
D230 1SS269	ANODE	-110dBm	AMP6 (10K~40MHz) RX : 3MHz (AM)
D232 1SS269	ANODE	-102dBm	
D230 1SS269	ANODE	-108dBm	AMP6 (10K~40MHz) RX : 30MHz (AM)
D232 1SS269	ANODE	-102dBm	
D280 1SS269	ANODE	-117dBm	AMP5 (40M~230MHz) RX : 57.5MHz (FM)
D259 1SS269	ANODE	-104dBm	
D280 1SS269	ANODE	-117dBm	AMP5 (40M~230MHz) RX : 112.5MHz (FM)
D259 1SS269	ANODE	-102dBm	
D280 1SS269	ANODE	-110dBm	AMP5 (40M~230MHz) RX : 190MHz (FM)
D259 1SS269	ANODE	-104dBm	
D62 1SV163	ANODE	-118dBm	AMP4 (230M~400MHz) RX : 315MHz (FM)
DBM1 5MXB24-7	1	-95dBm	
D246 1SS269	ANODE	-120dBm	AMP3 (400M~1GHz) RX : 550MHz (FM)
DBM2 5MXB25-75	1	-102dBm	
D246 1SS269	ANODE	-121dBm	AMP3 (400M~1GHz) RX : 850MHz (FM)
DBM2 5MXB25-75	1	-95dBm	
D54 1SV196	ANODE:INPUT	-110dBm	IF : 622.4MHz (FM)
R351 0 Ω	T2 SIDE	-96dBm	AMP (Fc : 622.4MHz)
R71 0 Ω	T2 SIDE	-92dBm	BPF (Fc : 622.4MHz)
R352 0 Ω	T3 SIDE	-93dBm	AMP (Fc : 622.4MHz)
DBM3 5MXB24-7	2	-94dBm	BPF (Fc : 622.4MHz)

AR5000 FRONT UNIT RF / IF (10.7MHz , 622.4MHz) LEVEL

OUTPUT CONDITIONS : 12 SINAD (AUDIO LEVEL), RX : AM (60 % ,BW:6KHz) ,FM (3.5KHz,BW:15KHz)

PARTS NO, NAME	CHECK POINT	LEVEL (dBm)	INSPECTION ITEMS
K1 RK1-9V	14:INPUT	-50dBm	RX : 128.9MHz (FM)
J2 TMP-J01X-V6	1	-37.2dBm	OUTPUT (IF :10.7MHz) : Z=50(OUTPUT OPEN)

INPUT CONDITIONS : RX OFF (FROM SIGNAL GEN), AM (60 % ,BW:6KHz) ,FM (3.5KHz,BW:15KHz)

PARTS NO, NAME	CHECK POINTS	LEVEL (dBm)	INSPECTION ITEMS	KEY OPERATIONS
VCO4 SMOP611	4	-3.6dBm	VCO:2ndLOC 611.7MHz	RF:128.9MHz , FM
IC6 UPC2709T	1 / 4	-20.8 / +1.9dBm	AMP:2ndLOC 611.7MHz	RF:128.9MHz , FM
L17 15nH	L17---R14	+2.6dBm	LPF (Fc=680MHz)	RF:128.9MHz , FM
J2 TMP-J01X-V6	1	+1.4dBm	ATT:1dB	RF:128.9MHz , FM
J2 TMP-J01X-V6	1	+5.6dBm	Z=50(OUTPUT OPEN)	RF:128.9MHz , FM
IC7 UPC1675G	4 / 2	-8.6 / -2.8dBm	AMP:2ndLOC 611.7MHz	RF:128.9MHz , FM
L20 8.8nH	L20---R51	-1.7dBm	LPF (Fc=680MHz)	RF:128.9MHz , FM
DBM1 5MXB24-7	3	-4.3dBm	ATT:1dB	RF:128.9MHz , FM
DBM1 5MXB24-7	1 / 2	-8.7 / -23.5dBm	NCO (5.9MHz) , DBM (617.6MHz)	RF:128.9MHz , FM
IC8 UPC1675G	4	-34.5dBm	BPF (Fc=620.45MHz)	RF:128.9MHz , FM
IC8 UPC1675G	2	-8.9dBm	AMP (617.6MHz)	RF:128.9MHz , FM
IC3 MB1504	8	-12.9dBm	BPF (Fc=620.45MHz)	RF:128.9MHz , FM
IC1 MB1501	8	-2.1dBm	LOOP FRQ (751.3MHz)	RF:128.9MHz , FM
VCO1 NIS-151	5	+3.5dBm	VCO (637.4MHz)	RF:15MHz , AM
D20 1SV196	A / C	-6.7 / -7.5dBm	VCO (637.4MHz)	RF:15MHz , AM
D3 1SV196	A / C	-6.3 / -7.3dBm	VCO (722.4MHz)	RF:100MHz , FM
D1 1SV196	A / C	-6.5 / -7.3dBm	VCO (872.4MHz)	RF:250MHz , FM
D2 1SV196	A / C	-7.0 / -7.5dBm	VCO (1032.4MHz)	RF:410MHz , FM
D4 1SV196	A / C	-6.3 / -7.4dBm	VCO (1202.4MHz)	RF:580MHz , FM
R62 10 Ω	C26---R62	-7.1dBm	VCO (792.4MHz)	RF:170MHz , FM
R62 10 Ω	C26---R62	-8.4dBm	VCO (1122.4MHz)	RF:500MHz , FM
R62 10 Ω	C26---R62	-6.5dBm	VCO (721.2MHz)	RF:820MHz , FM
R62 10 Ω	C26---R62	-7.6dBm	VCO (861.2MHz)	RF:1100MHz , FM
D14 RN711H	A / C	-18 / -18.2dBm	VCO (792.4MHz)	RF:170MHz , FM
D15 RN711H	A / C	-21 / -20.8dBm	VCO (1122.4MHz)	RF:500MHz , FM
D16 RN711H	A / C	-14.1 / -14.6dBm	VCO (721.2MHz)	RF:820MHz , FM
D16 RN711H	A / C	-19 / -19.4dBm	VCO (861.2MHz)	RF:1100MHz , FM
IC9 UPC2709T	4	+2.1dBm	AMP (792.4MHz)	RF:170MHz , FM
IC12 UPC2709T	4	-0.8dBm	AMP (1122.4MHz)	RF:500MHz , FM
IC14 UPC2709T	4	+1.6dBm	AMP (721.2MHz)	RF:820MHz , FM
IC14 UPC2709T	4	-0.7dBm	AMP (861.2MHz)	RF:1100MHz , FM
D12 RN711H	C / A	+3.8 / -3.2dBm	LPF (792.4MHz)	RF:170MHz , FM
D11 RN711H	C / A	-2.2 / -2.4dBm	LPF (1122.4MHz)	RF:500MHz , FM
FDB1 5FDB-1	3	+1.8dBm	LPF (721.2MHz)	RF:820MHz , FM
FDB1 5FDB-1	3	-3.3dBm	LPF (861.2MHz)	RF:1100MHz , FM
FDB1 5FDB-1	1	-13.4dBm	DOUBLER (1442.4MHz)	RF:820MHz , FM
FDB1 5FDB-1	1	-18.9dBm	DOUBLER (1722.4MHz)	RF:1100MHz , FM
IC11 UPC2709T	1 / 4	-16.8 / +0.3dBm	AMP (1442.4MHz)	RF:820MHz , FM
IC13 UPC2709T	1 / 4	-13.1 / -1.3dBm	AMP (1722.4MHz)	RF:1100MHz , FM
D10 RN711H	C / A	-1.7 / -1.3dBm	BPF (1442.4MHz)	RF:820MHz , FM
D13 RN711H	C / A	-5.7 / -2.5dBm	BPF (1722.4MHz)	RF:1100MHz , FM
R55 3.3 Ω	R55---J1	+2dBm	ATT:1dB (792.4MHz)	RF:170MHz , FM
R55 3.3 Ω	R55---J1	-2.5dBm	ATT:1dB (1122.4MHz)	RF:500MHz , FM
R55 3.3 Ω	R55---J1	-2.4dBm	ATT:1dB (1442.4MHz)	RF:820MHz , FM

AR5000 PLL UNIT STD (10M/12.8MHz) OSC / VCO / SUBCAR / 1st,2nd LOCAL LEVEL

INPUT CONDITIONS : RX OFF (FROM SIGNAL GEN) , AM (60 % ,BW:6KHz) ,FM (3.5KHz,BW:15KHz)

PARTS NO, NAME	CHECK POINTS	LEVEL (dBm)	INSPECTION ITEMS	KEY OPERATIONS
R55 3.3 Ω	R55---J1	-5.9dBm	ATT:1dB (1722.4MHz)	RF:1100MHz , FM
IC10 UPC1675G	4 / 2	-12 / -2.8dBm	AMP (792.4MHz)	RF:170MHz , FM
IC10 UPC1675G	4 / 2	-15 / -6.9dBm	AMP (1122.4MHz)	RF:500MHz , FM
IC1 MB1501	8	-2.1dBm	LOOP LPF (792.4MHz)	RF:170MHz , FM
IC1 MB1501	8	-8.6dBm	LOOP LPF (1122.4MHz)	RF:500MHz , FM
R111 0 Ω	R111---L60	+4.2dBm	PLL OSC (4.54MHz)	RF:128.9MHz , CW
IC1 MB1501	8	+2.2dBm	LOOP LPF (4.54MHz)	RF:128.9MHz , CW
Q36 2SC1009A	EMITTER (1)	+1.1dBm	BUFF AMP (454KHz)	RF:128.9MHz , CW
L64 100uH	L64---C204	-1.5dBm	LPF (454KHz)	RF:128.9MHz , CW
J3 TMP-J01X-V6	1	-3.6dBm	LPF (454KHz)	RF:128.9MHz , CW
J3 TMP-J01X-V6	1	-3.3dBm	Z=50(OUTPUT OPEN)	RF:128.9MHz , CW
Q44 2SC2759	COLLECTOR (3	-3.6dBm	TANK CIRCUIT (WAVE:12.8MHz)	RF:128.9MHz , FM , INT STD:12.8MHz
D24 1SV196	ANODE	-3.6dBm		
L66 560nH	L66---C220	-7.2dBm	LPF (SINE WAVE OUT)	INT STD:12.8MHz
J4 TMP-J01X-V6	1	0.0dBm	EXTERNAL INPUT	RF:128.9MHz , FM , EXT STD:10MHz
L68 680nH	L68---C225	-1.2dBm	LPF (WAVE:10MHz)	EXT STD:10MHz
D25 1SV196	ANODE	-1.9dBm		
L66 560nH	L66---C220	-7.6dBm	LPF (SINE WAVE OUT)	EXT STD:10MHz

AR5000 IF UNIT IF(455KHz, 10.7MHz) LEVEL

INPUT (J7) CONDITION S : IF1 (10.7MHz, -107dBm, AM : 60 %)
 : IF2 (10.7MHz, -107dBm, CW)
 : IF3 (10.7MHz, -107dBm, FM : 1.75KHz)
 : IF4 (10.7MHz, -107dBm, FM :3.5KHz)
 : IF5 (10.7MHz, -107dBm, FM :7KHz)
 : IF6 (10.7MHz, -107dBm, FM :25KHz)
 : IF7 (10.7MHz, -107dBm, FM :50KHz)

OUTPUT CONDITION : 12 SINAD (AUDIO LEVEL)

PARTS NO, NAME	CHECK POINT	LEVEL (dBm)	INSPECTION ITEMS	KEY OPERATIONS	NO.
Q3 2SK520	SOURCE (2)	-109dBm	BUFF AMP	FM (BW:15KHz)	IF4
T1 KE-07651	4	-110dBm	TRANSFORMER	FM (BW:15KHz)	IF4
D1 RN711H	ANODE	-98dBm	AMP (Q4)	CW (BW:3KHz)	IF2
D2 RN711H	ANODE	-96dBm	AMP (Q4)	FM (BW:6KHz)	IF3
D3 RN711H	ANODE	-95dBm	AMP (Q4)	FM (BW:15KHz)	IF4
D4 RN711H	ANODE	-81dBm	AMP (Q4)	FM (BW:30KHz)	IF5
D5 RN711H	ANODE	-89dBm	AMP (Q4)	FM (BW:110KHz)	IF6
D6 RN711H	ANODE	-88dBm	AMP (Q4)	FM (BW:220KHz)	IF7
D10 RN711H	ANODE	-102dBm	BPF (BW:3KHz)	CW (BW:3KHz)	IF2
D11 RN711H	ANODE	-102dBm	BPF (BW:6KHz)	FM (BW:6KHz)	IF3
D12 1SV196	ANODE	-102dBm	BPF (BW:15KHz)	FM (BW:15KHz)	IF4
D7 1SV196	ANODE	-102dBm	BPF (BW:30KHz)	FM (BW:30KHz)	IF5
D8 1SV196	ANODE	-102dBm	BPF (BW:110KHz)	FM (BW:110KHz)	IF6
D9 1SV196	ANODE	-102dBm	BPF (BW:220KHz)	FM (BW:220KHz)	IF7
D13 RN711H	ANODE	-94dBm	AMP (Q6)	FM (BW:220KHz)	IF7
T7 KE-07496-1	4	-69dBm	AMP (Q7)	FM (BW:15KHz)	IF4
D28 RN711H	ANODE	-87dBm	MIXER 455KHz (IC8)	CW (BW:3KHz)	IF2
D30 RN711H	ANODE	-82dBm	MIXER 455KHz (IC8)	FM (BW:6KHz)	IF3
D32 RN711H	ANODE	-84dBm	MIXER 455KHz (IC8)	FM (BW:15KHz)	IF4
D34 RN711H	ANODE	-84dBm	MIXER 455KHz (IC8)	FM (BW:30KHz)	IF5
D36 RN711H	ANODE	-84dBm	MIXER 455KHz (IC8)	FM (BW:110KHz)	IF6
D38 RN711H	ANODE	-83dBm	MIXER 455KHz (IC8)	FM (BW:220KHz)	IF7
D29 RN711H	ANODE	-86dBm	BPF (BW:3KHz)	CW (BW:3KHz)	IF2
D31 RN711H	ANODE	-86dBm	BPF (BW:6KHz)	FM (BW:6KHz)	IF3
D33 RN711H	ANODE	-86dBm	BPF (BW:15KHz)	FM (BW:15KHz)	IF4
D35 RN711H	ANODE	-86dBm	BPF (BW:30KHz)	FM (BW:30KHz)	IF5
D37 RN711H	ANODE	-86dBm	BPF (BW:110KHz)	FM (BW:110KHz)	IF6
D39 RN711H	ANODE	-86dBm	BPF (BW:220KHz)	FM (BW:220KHz)	IF7
VR1 10K Ω	2	-86dBm	AMP (Q25) :TP1	AM (BW:6KHz)	IF1
T11 KE-04980	3	-54dBm	AMP (Q26)	AM (BW:6KHz)	IF1
C113 22pF	C113---R139	-32dBm	AMP (Q27)	AM (BW:6KHz)	IF1
Q29 2SC1009A	EMITTER (1)	-5dBm	AMP (Q29)	AM (BW:6KHz)	IF1

AR5000 REPAIR FLOW CHART

1. PLL ERROR

1-1. Cause of PLL ERROR

- ① Unlock 1st local injection only
- ② Unlock 2nd local injection only
- ③ Unlock both local injections

1-2. Finding a defective point

1-2-1. Unlock 1st local injection only

CP: check point

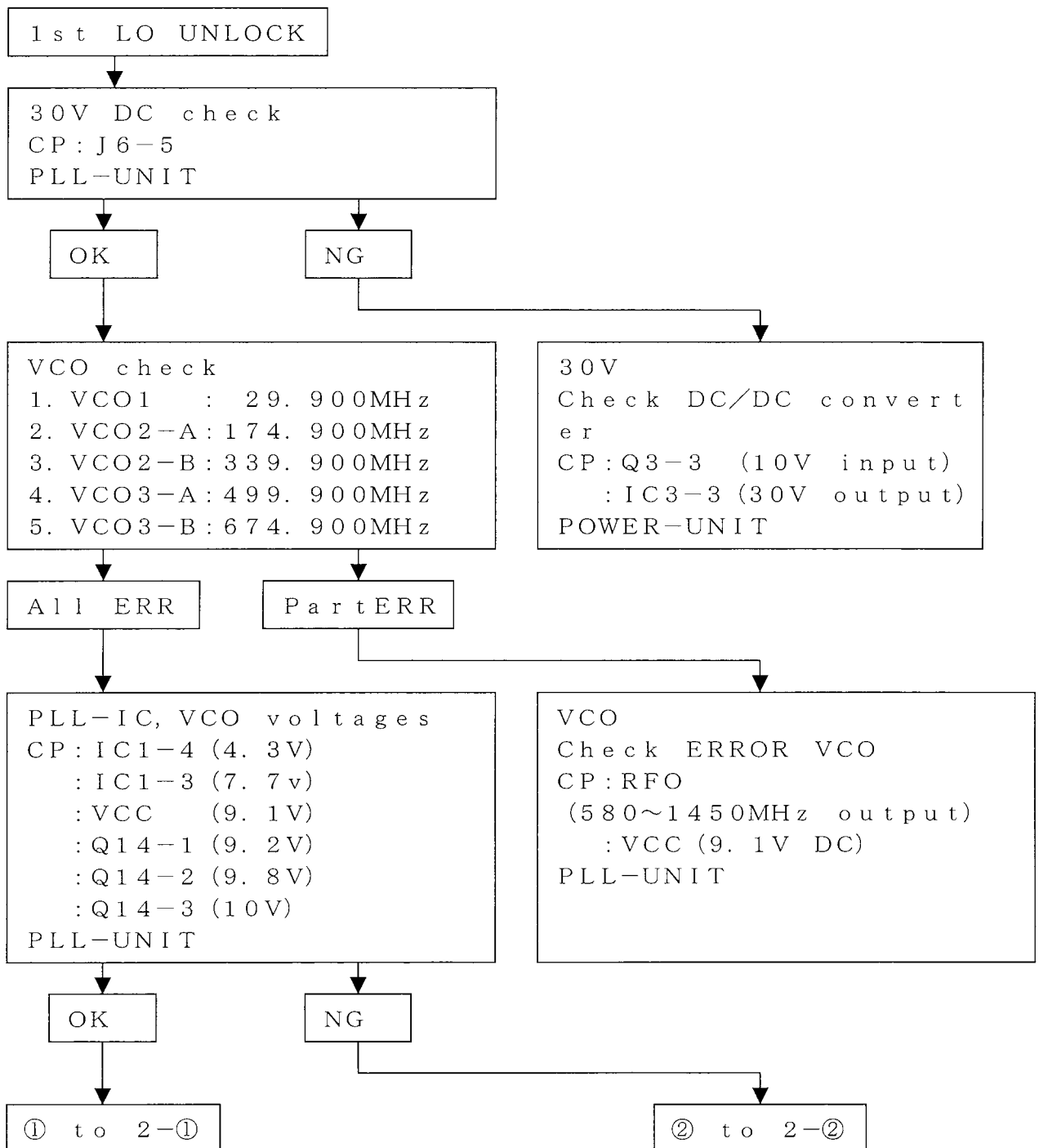

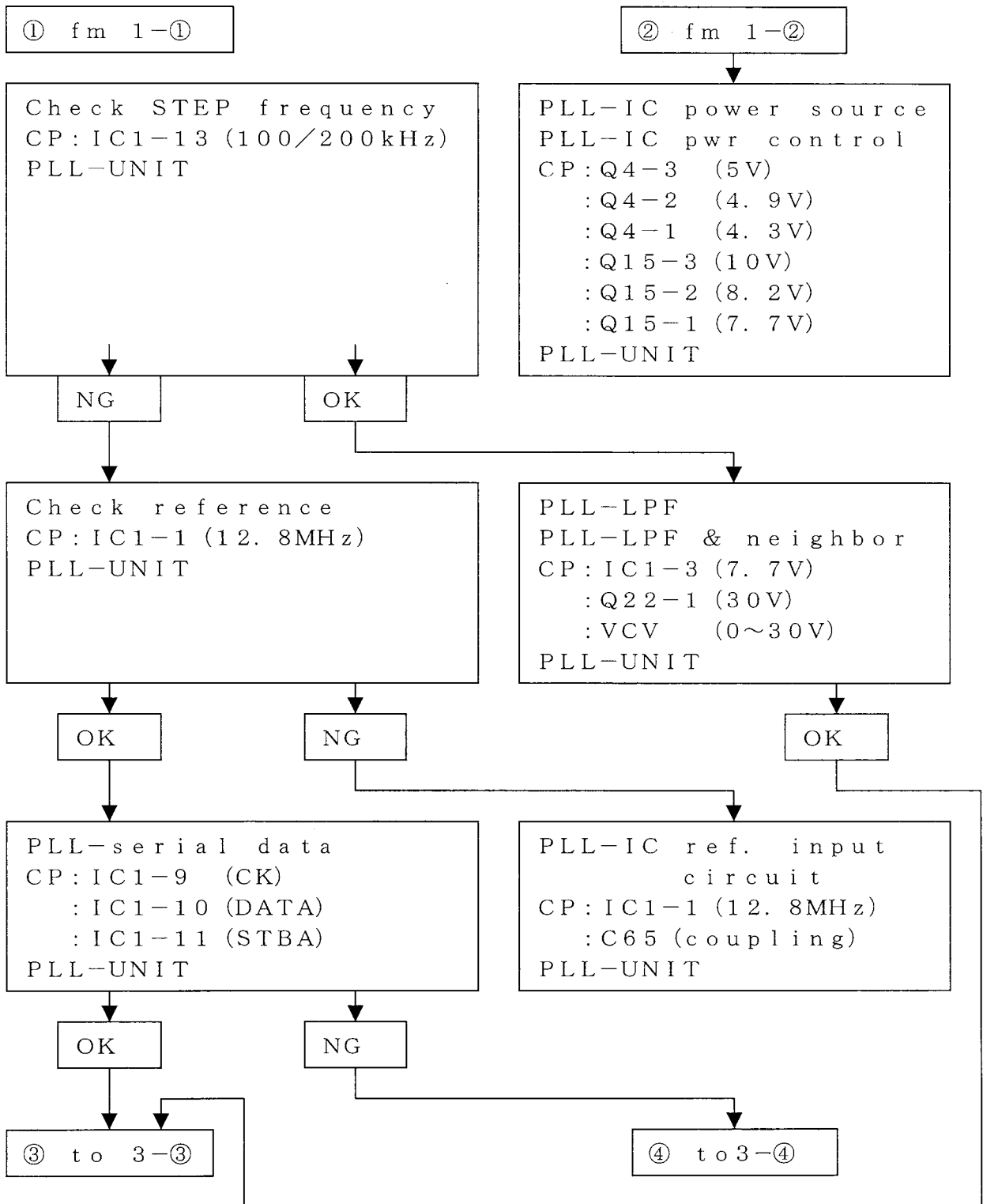

③ fm 2-③

PLL-IC RF input/signal
CP: IC1-8 (580~1450MHz)
PLL-UNIT

NG

PLL-IC RF input
PLL-IC RF neighbor
CP: FILTER (A)
PLL-UNIT

④ fm 2-④

PLL-serial data
PLL-neighbor circuit
CP: IC1-9 (CK)
: IC1-10 (DATA)
: IC1-11 (STBA)
: D6-3 (CK)
: D6-2 (DATA)
: D6-1 (STBA)
PLL-UNIT

1-2-2. 2nd local UNLOCK
 CP: check point

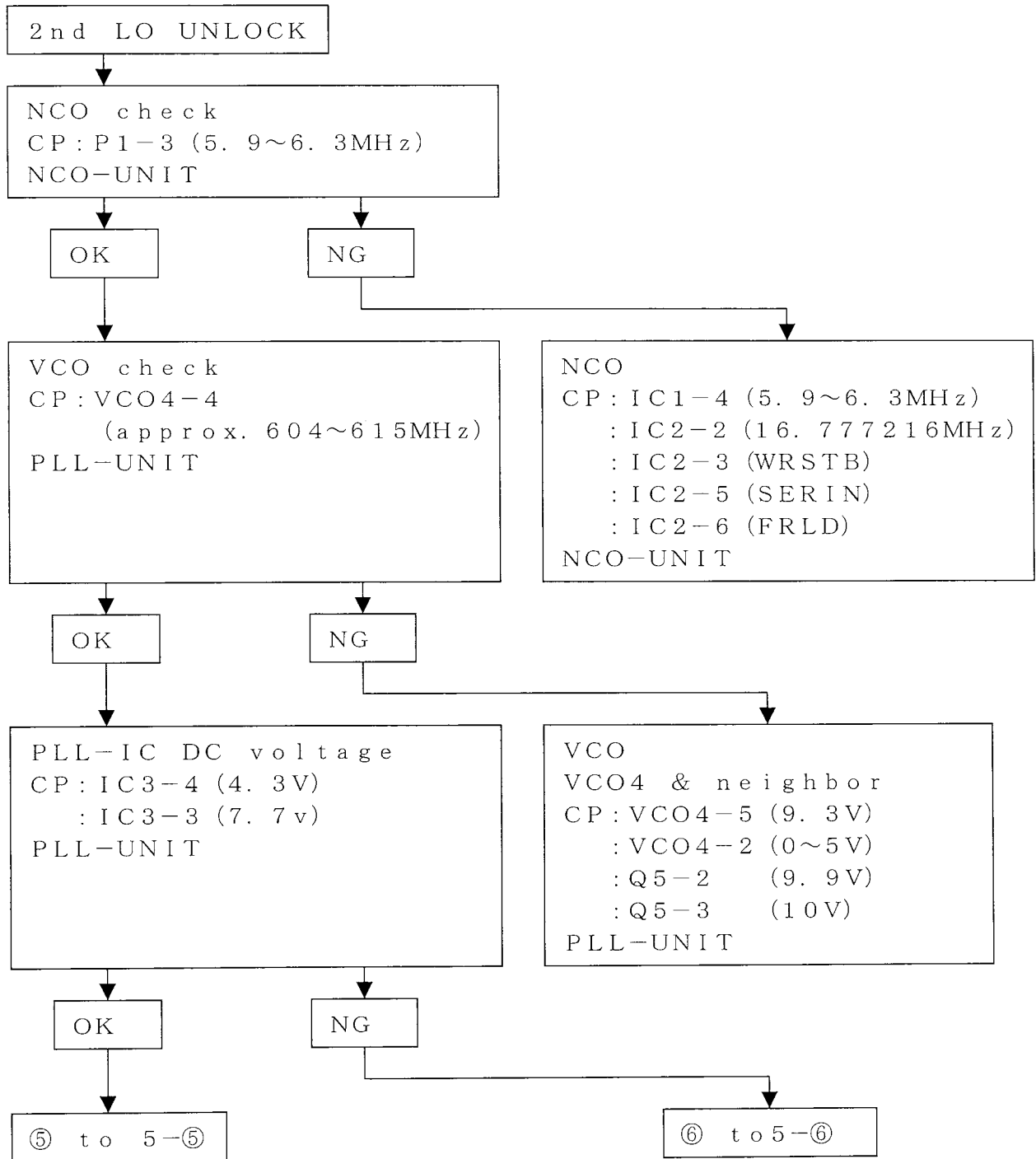

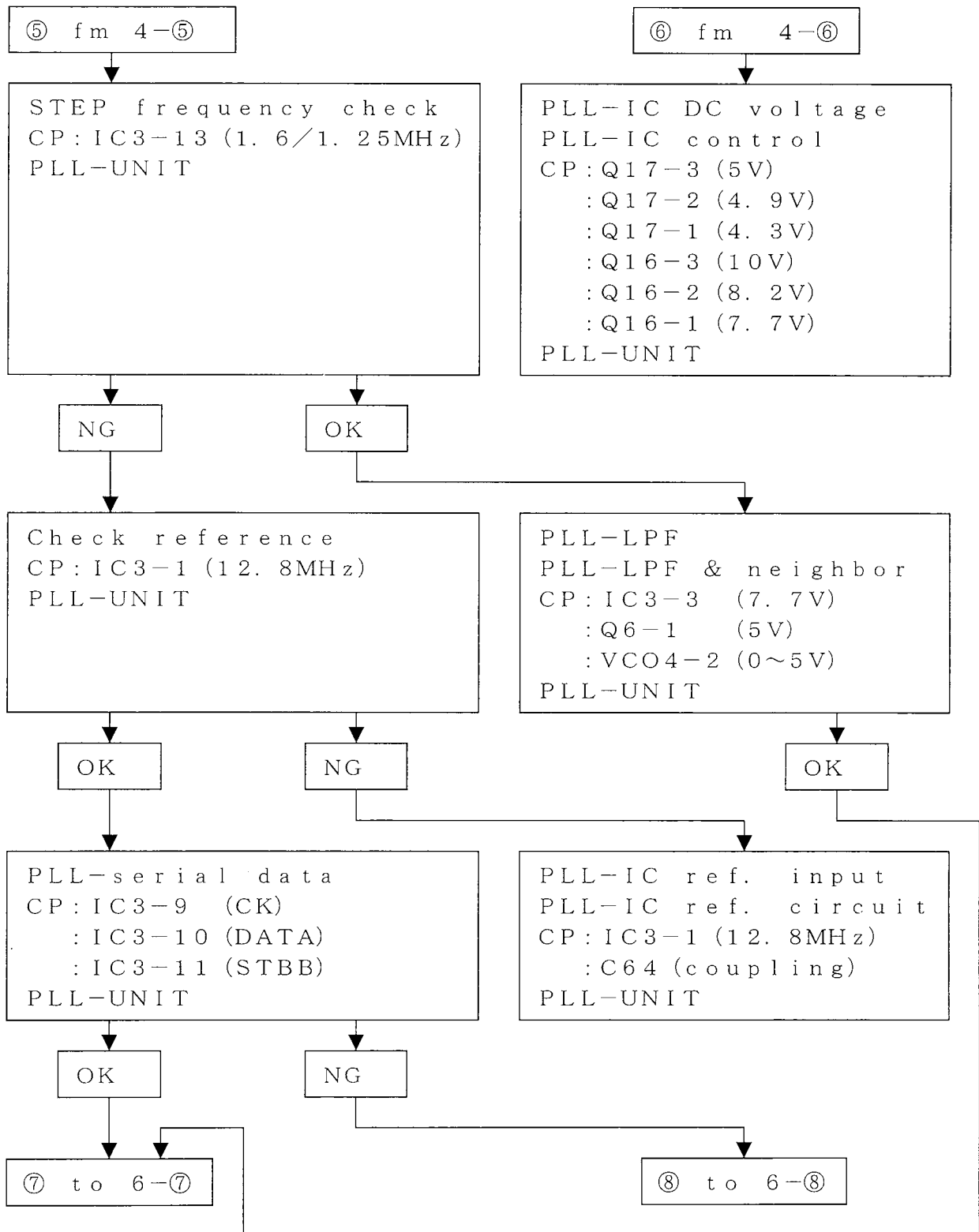

⑦ fm 5-⑦

PLL-IC
RF input signal
CP: IC3-8
(approx. 609~622MHz)
PLL-UNIT

NG

PLL-IC RF input
PLL-IC RF neighbors
CP: FILTER (H)
: FILTER (J)
: DBM1
PLL-UNIT

⑧ fm 5-⑧

PLL-serial data
PLL-neighbors
CP: IC3-9 (CK)
: IC3-10 (DATA)
: IC3-11 (STBB)
: D7-3 (CK)
: D7-2 (DATA)
: D7-1 (STBB)
PLL-UNIT

1-2-3. Both Local UNLOCK
 CP: check point

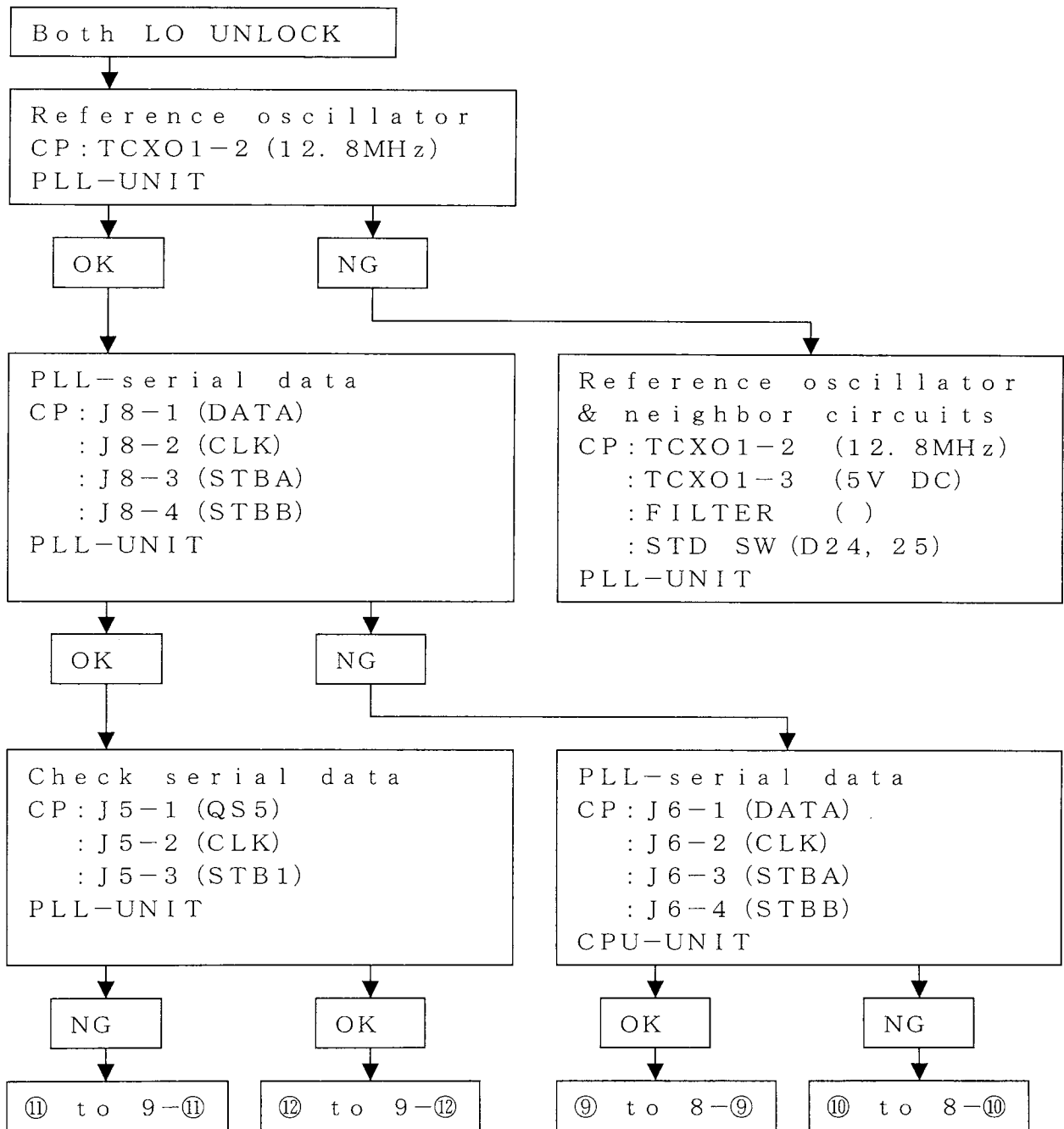

⑨ fm 7-⑨

Check wirings
poor connections
specially for between
PLL-UNIT and
CPU-UNIT

⑩ fm 7-⑩

PLL-serial data
CP: IC2-1, 2 (DATA)
: IC2-5, 6 (CLK)
: IC2-3, 7 (4.8V)
: IC3-44 (DATA)
: IC3-45 (CLK)
: IC3-46 (STBA)
: IC3-47 (STBB)
CPU-UNIT

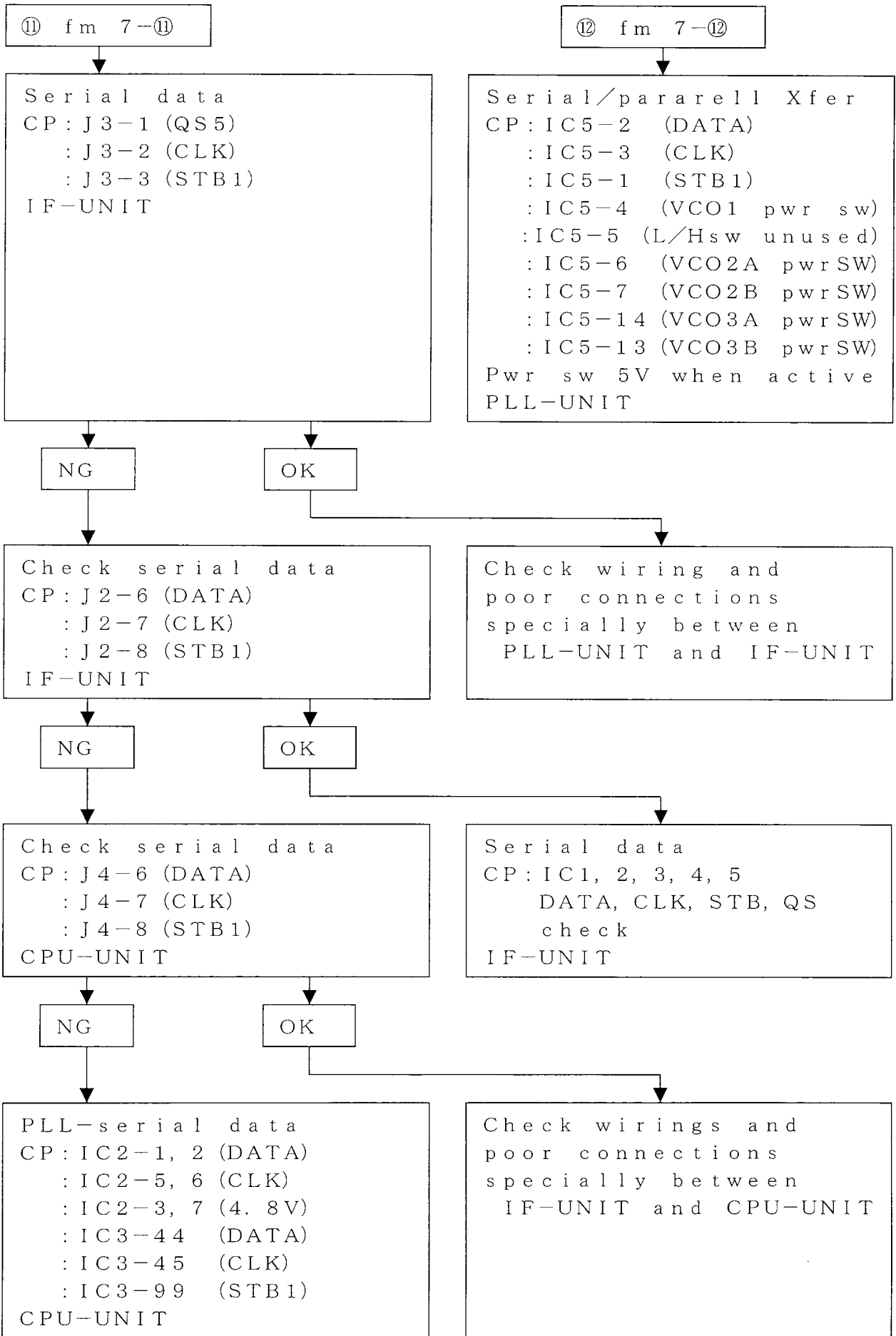

13: 20: 50 SEP 06, 1997

FIRST LOCAL FILTER-A

PLL1 - A

MKR 1.325 GHz
REF 10.0 dBm AT 10 dB

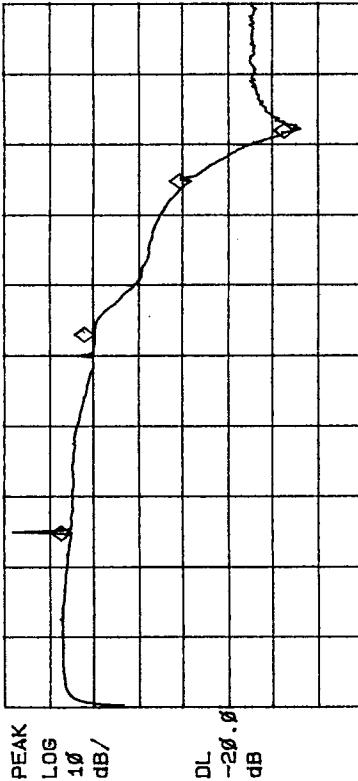

Marker	Trace Type	Freq	Time	Amplitude
1:	(A)	619 MHz		5.02dBm
2:	(A)	1325 MHz		-0.35dBm
3:	(A)	1869 MHz		-21.68dBm
4:	(A)	2050 MHz		-44.99dBm

START 0 Hz #RES BW 1.0 MHz VBW 300 kHz STOP 2.500 GHz SWP 50.0 msec

13: 06: 59 SEP 06, 1997

FIRST LOCAL FILTER-B

PLL1 - B

MKR 990 MHz
REF 10.0 dBm AT 20 dB

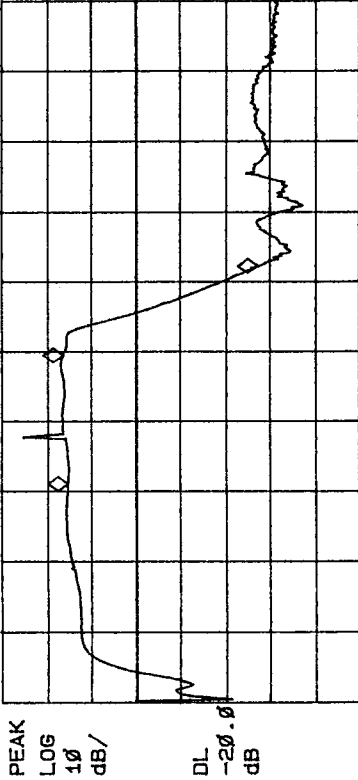

Marker	Trace Type	Freq	Time	Amplitude
1:	(A)	620 MHz		15.21dBm
2:	(A)	990 MHz		16.25dBm
3:	(A)	1245 MHz		-27.44dBm
4:	Inactive			

START 0 Hz #RES BW 1.0 MHz VBW 300 kHz STOP 2.000 GHz SWP 40.0 msec

13: 04: 52 SEP 06, 1997

FIRST LOCAL FILTER-C

PLL1 - C

MKR 1.325 GHz
REF 10.0 dBm AT 20 dB

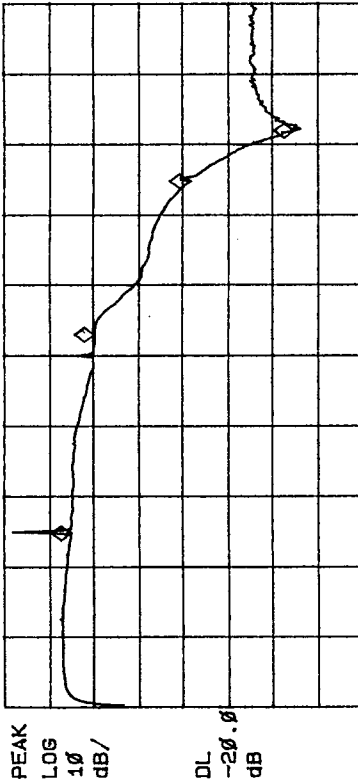

Marker	Trace Type	Freq	Time	Amplitude
1:	(A)	956 MHz		16.22dBm
2:	(A)	1325 MHz		14.46dBm
3:	(A)	1925 MHz		-34.17dBm
4:	Inactive			

START 0 Hz #RES BW 1.0 MHz VBW 300 kHz STOP 2.500 GHz SWP 50.0 msec

13: 14: 53 SEP 06, 1997

FIRST LOCAL FILTER-D

PLL1 - D

MKR 1.090 GHz
REF 10.0 dBm AT 20 dB

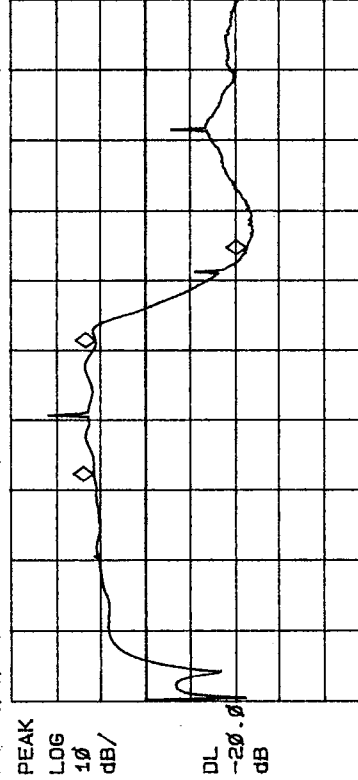

Marker	Trace Type	Freq	Time	Amplitude
1:	(A)	645 MHz		11.48dBm
2:	(A)	1090 MHz		11.00dBm
3:	(A)	1295 MHz		-22.67dBm
4:	Inactive			

START 0 Hz #RES BW 1.0 MHz VBW 300 kHz STOP 2.000 GHz SWP 40.0 msec

13:55:31 SEP 06, 1997

FIRST LOCAL FILTER-E PLL2-A MKR 1.617 GHz
REF 10.0 dBm AT 20 dB 17.36 dB

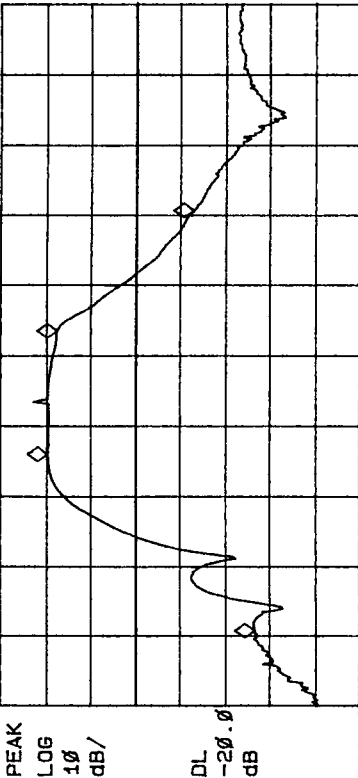

Marker	Trace Type	Freq / Time	Amplitude
1:	(A)	804 MHz	-26.80dBdBL
2:	(A)	1284 MHz	19.49dBdBL
3:	(A)	1617 MHz	17.36dBdBL
4:	(A)	1944 MHz	-13.02dBdBL

START 600 MHz #RES BW 1.0 MHz VBW 300 kHz STOP 2.500 GHz
SNP 38.0 msec

1. IN
① C181 OPEN
② D17-A
③ LEVEL -20dBm
④ AC (100PH)
2. OUT
① J1
② DCI
800.9 MHz FM

14:04:17 SEP 06, 1997

FIRST LOCAL FILTER-F PLL2-B MKR 2.034 GHz
REF 10.0 dBm AT 20 dB 16.16 dB

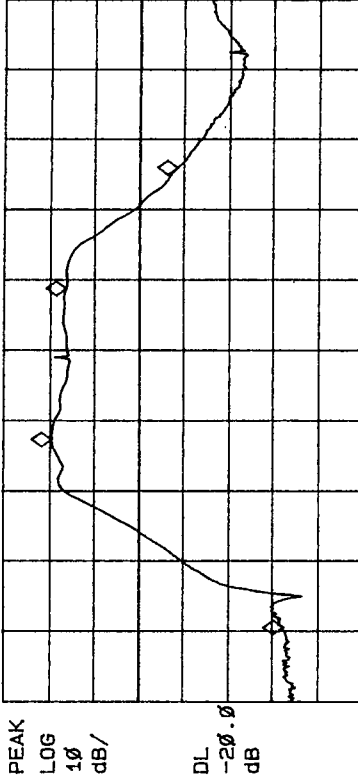

Marker	Trace Type	Freq / Time	Amplitude
1:	(A)	1021 MHz	-32.60dBdBL
2:	(A)	1582 MHz	19.35dBdBL
3:	(A)	2034 MHz	16.16dBdBL
4:	(A)	2396 MHz	-8.59dBdBL

START 800 MHz #RES BW 1.0 MHz VBW 300 kHz STOP 2.900 GHz
SNP 42.0 msec

1. IN
Same as A
2. OUT
Same as A
1200.9 MHz FM

13:50:15 SEP 06, 1997

FIRST LOCAL FILTER-E PLL2-C MKR 1.617 GHz
REF 10.0 dBm AT 20 dB 17.14 dB

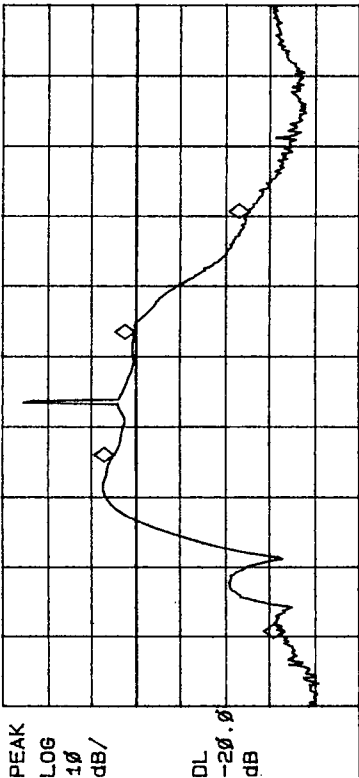

Marker	Trace Type	Freq / Time	Amplitude
1:	(A)	804 MHz	-33.29dBdBL
2:	(A)	1284 MHz	4.85dBdBL
3:	(A)	1617 MHz	0.14dBdBL
4:	(A)	1944 MHz	-25.44dBdBL

START 600 MHz #RES BW 1.0 MHz VBW 300 kHz STOP 2.500 GHz
SNP 38.0 msec

1. IN
① HDB1-1
② LEVEL -20dBm
③ DC
2. OUT
① J1
② DCI
800.9 MHz FM

14:08:29 SEP 06, 1997

FIRST LOCAL FILTER-F PLL2-D MKR 2.034 GHz
REF 10.0 dBm AT 20 dB 4.16 dB

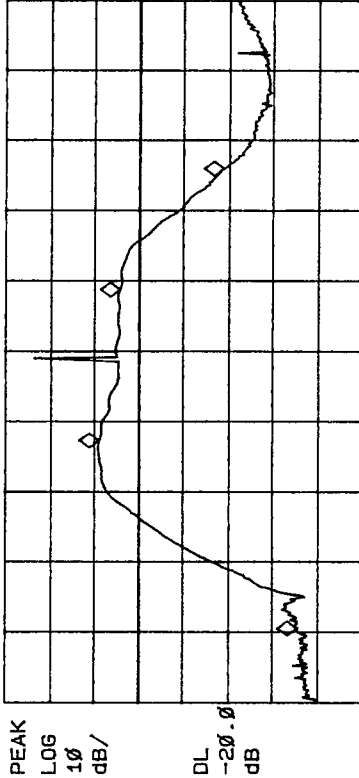

Marker	Trace Type	Freq / Time	Amplitude
1:	(A)	1021 MHz	-35.72dBdBL
2:	(A)	1582 MHz	8.87dBdBL
3:	(A)	2034 MHz	4.16dBdBL
4:	(A)	2396 MHz	-19.11dBdBL

START 800 MHz #RES BW 1.0 MHz VBW 300 kHz STOP 2.900 GHz
SNP 42.0 msec

1. IN
Same as C
2. OUT
Same as C
1200.9 MHz FM

19:17:33 SEP 05, 1997

SECOND LOCAL FILTER-H PLL3-A MKR 650 MHz
REF .0 dBm AT 10 dB

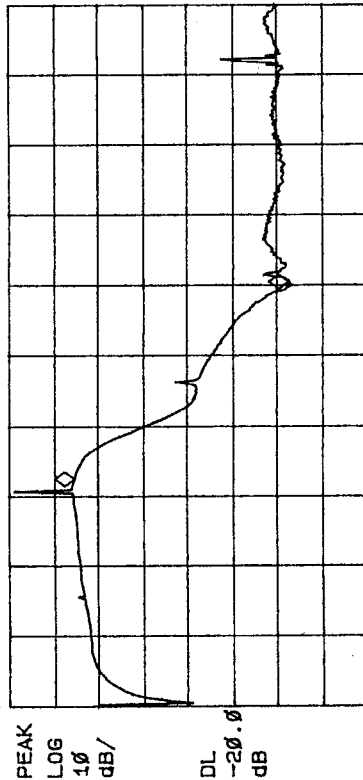

1. IN
 ① R53 → C76
 ② LEVEL -20dBm
 ③ DC
 2. OUT
 ① L20 → R51
 ② DC
 129.9 MHz FM

Marker	Trace Type	Freq / Time	Amplitude
1:	(A) Freq	650 MHz	5.25dBm
2:	(A) Freq	1210 MHz	-42.85dBm
3:	Inactive		
4:	Inactive		

START 0 Hz #RES BW 1.0 MHz VBW 300 kHz STOP 2.000 GHz
 SWP 40.0 msec

19:19:02 SEP 05, 1997

SECOND LOCAL FILTER-H PLL3-B MKR 650 MHz
REF .0 dBm AT 10 dB

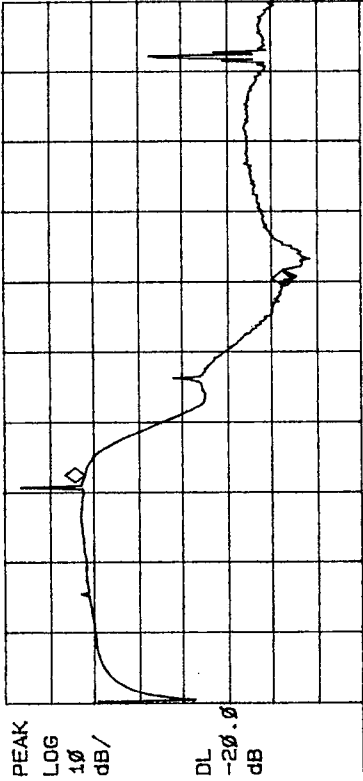

1. IN
 Same as A
 2. OUT
 ① DBM1-3
 ② DC
 129.9 MHz FM

Marker	Trace Type	Freq / Time	Amplitude
1:	(A) Freq	650 MHz	1.92dBm
2:	(A) Freq	1210 MHz	-44.69dBm
3:	Inactive		
4:	Inactive		

START 0 Hz #RES BW 1.0 MHz VBW 300 kHz STOP 2.000 GHz
 SWP 40.0 msec

19:26:49 SEP 05, 1997

SECOND LOCAL FILTER-J PLL3-C MKR 620.45 MHz
REF .0 dBm AT 10 dB

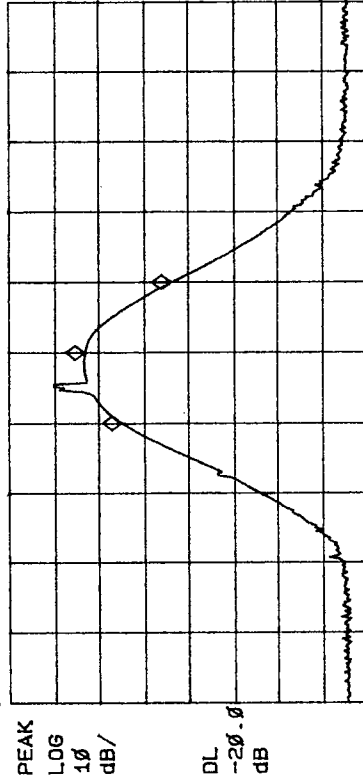

1. IN
 ① T1-1
 ② LEVEL -20dBm
 ③ DC
 2. OUT
 ① T2-5
 ② DC
 129.9 MHz FM

Marker	Trace Type	Freq / Time	Amplitude
1:	(A) Freq	615.45 MHz	-5.22dBm
2:	(A) Freq	620.45 MHz	2.94dBm
3:	(A) Freq	625.45 MHz	-16.31dBm
4:	Inactive		

CENTER 620.45 MHz #RES BW 100 kHz VBW 30 kHz SPAN 50.00 MHz
 SWP 50.0 msec

19:08:57 SEP 05, 1997

SECOND LOCAL FILTER-G PLL3-D MKR 650 MHz
REF 10.0 dBm AT 20 dB

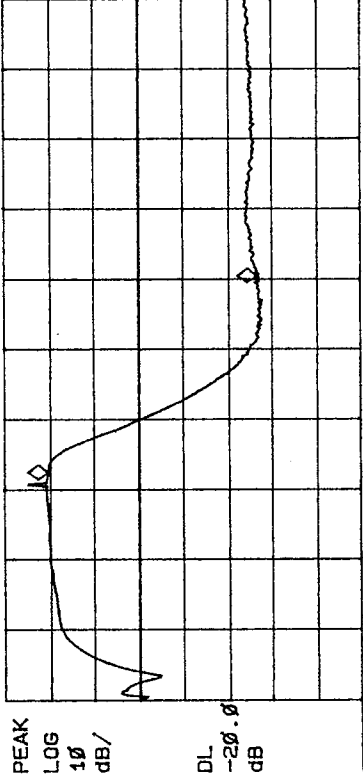

1. IN
 ① R133 → C11
 ② LEVEL -20dBm
 ③ DC
 2. OUT
 ① J2
 ② DC2
 129.9 MHz FM

Marker	Trace Type	Freq / Time	Amplitude
1:	(A) Freq	650 MHz	20.25dBm
2:	(A) Freq	1210 MHz	-26.79dBm
3:	Inactive		
4:	Inactive		

START 0 Hz #RES BW 1.0 MHz VBW 300 kHz STOP 2.000 GHz
 SWP 40.0 msec

15:04:12 SEP 06, 1997

FIRST LOCAL FILTER-A PLL4 - A MKR 620 MHz
REF 10.0 dBm AT 20 dB 2.40 dBm

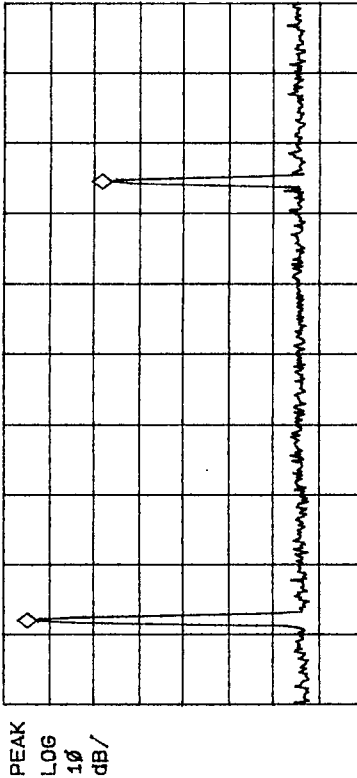

MEASUREMENT
① VC01-5
② AC

Marker	Trace Type	Freq / Time	Amplitude
1:	(A)	620 MHz	2.40 dBm
2:	(A)	1245 MHz	-14.09 dBm
3:	Inactive		
4:	Inactive		

10KHz FM

CENTER 1.000 GHz RES BW 3.0 MHz VBW 1 MHz SPAN 1.000 GHz SWP 20.0 msec

15:06:36 SEP 06, 1997

FIRST LOCAL FILTER-A PLL4 - B MKR 620 MHz
REF 10.0 dBm AT 20 dB -13.53 dBm

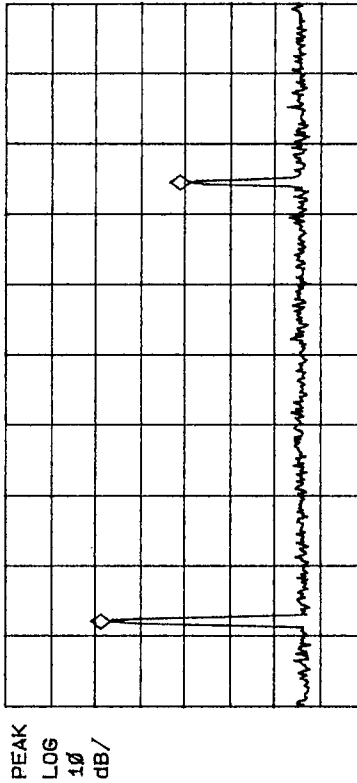

MEASUREMENT
① IC10-4
② AC

Marker	Trace Type	Freq / Time	Amplitude
1:	(A)	620 MHz	-13.53 dBm
2:	(A)	1245 MHz	-31.20 dBm
3:	Inactive		
4:	Inactive		

10KHz FM

CENTER 1.000 GHz RES BW 3.0 MHz VBW 1 MHz SPAN 1.000 GHz SWP 20.0 msec

15:00:45 SEP 06, 1997

FIRST LOCAL FILTER-A PLL4 - C MKR 620 MHz
REF 10.0 dBm AT 20 dB -8.53 dBm

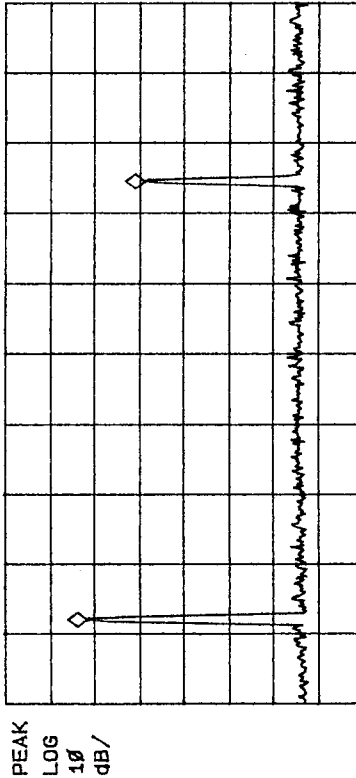

MEASUREMENT
① IC10-2
② AC

Marker	Trace Type	Freq / Time	Amplitude
1:	(A)	620 MHz	-8.53 dBm
2:	(A)	1245 MHz	-21.45 dBm
3:	Inactive		
4:	Inactive		

10KHz FM

CENTER 1.000 GHz RES BW 3.0 MHz VBW 1 MHz SPAN 1.000 GHz SWP 20.0 msec

15:02:33 SEP 06, 1997

FIRST LOCAL FILTER-A PLL4 - D MKR 620 MHz
REF 10.0 dBm AT 20 dB -2.11 dBm

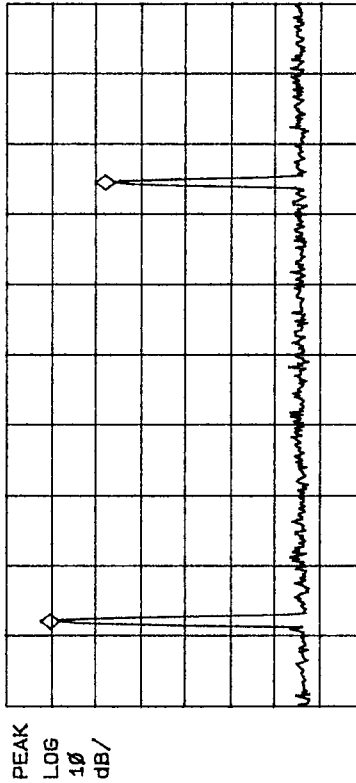

MEASUREMENT
① IC1-8
② AC

Marker	Trace Type	Freq / Time	Amplitude
1:	(A)	620 MHz	-2.11 dBm
2:	(A)	1245 MHz	-14.45 dBm
3:	Inactive		
4:	Inactive		

10KHz FM

CENTER 1.000 GHz RES BW 3.0 MHz VBW 1 MHz SPAN 1.000 GHz SWP 20.0 msec

15: 14: 16 SEP 06, 1997
FIRST LOCAL FILTER-A PLL5 - A
REF 10.0 dBm AT 20 dB MKR 962 MHz
-6.04 dBm

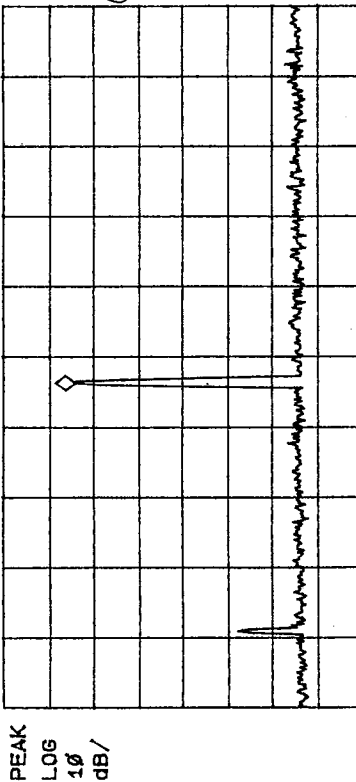

Marker	Trace Type	Freq	Time	Amplitude
1:	(A) Freq	963 MHz		-6.04 dBm
2:	Inactive			
3:	Inactive			
4:	Inactive			

CENTER 1.000 GHz
RES BW 3.0 MHz
SPAN 1.000 GHz
SMP 20.0 msec
VBW 1 MHz

15: 17: 28 SEP 06, 1997
FIRST LOCAL FILTER-A PLL5 - B
REF 10.0 dBm AT 20 dB MKR 962 MHz
-13.66 dBm

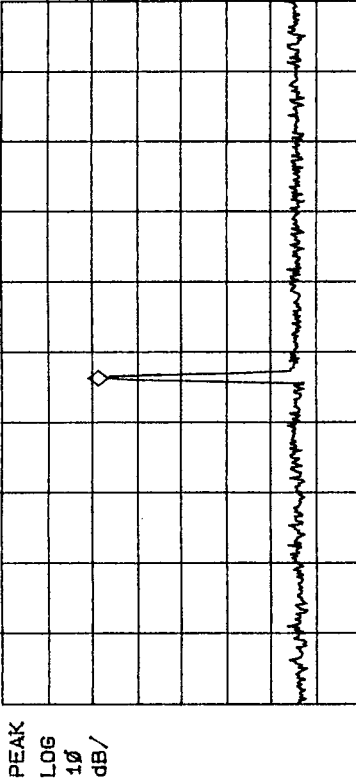

Marker	Trace Type	Freq	Time	Amplitude
1:	(A) Freq	963 MHz		-13.66 dBm
2:	Inactive			
3:	Inactive			
4:	Inactive			

CENTER 1.000 GHz
RES BW 3.0 MHz
SPAN 1.000 GHz
SMP 20.0 msec
VBW 1 MHz

15: 19: 19 SEP 06, 1997
FIRST LOCAL FILTER-A PLL5 - C
REF 10.0 dBm AT 20 dB MKR 962 MHz
-2.37 dBm

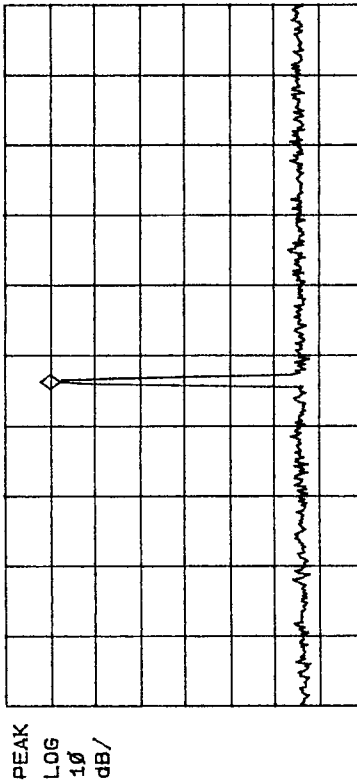

Marker	Trace Type	Freq	Time	Amplitude
1:	(A) Freq	963 MHz		-2.37 dBm
2:	Inactive			
3:	Inactive			
4:	Inactive			

CENTER 1.000 GHz
RES BW 3.0 MHz
SPAN 1.000 GHz
SMP 20.0 msec
VBW 1 MHz

15: 21: 24 SEP 06, 1997
FIRST LOCAL FILTER-A PLL5 - D
REF 10.0 dBm AT 20 dB MKR 962 MHz
-2.34 dBm

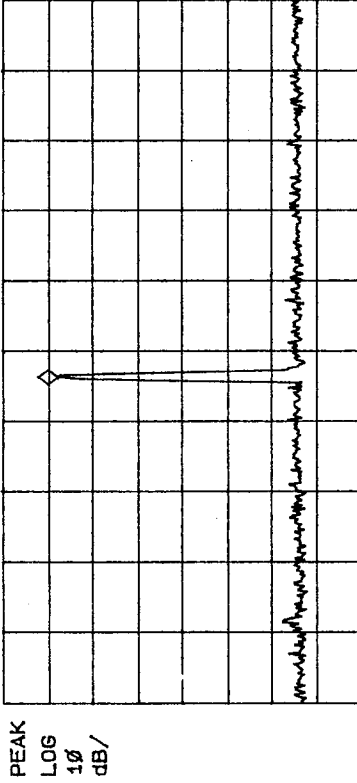

Marker	Trace Type	Freq	Time	Amplitude
1:	(A) Freq	963 MHz		-2.34 dBm
2:	Inactive			
3:	Inactive			
4:	Inactive			

CENTER 1.000 GHz
RES BW 3.0 MHz
SPAN 1.000 GHz
SMP 20.0 msec
VBW 1 MHz

15: 25: 52 SEP 06, 1997
 FIRST LOCAL FILTER-A PLL6 - A
 REF 10.0 dBm AT 20 dB MKR 1.298 GHz
 -6.88 dBm

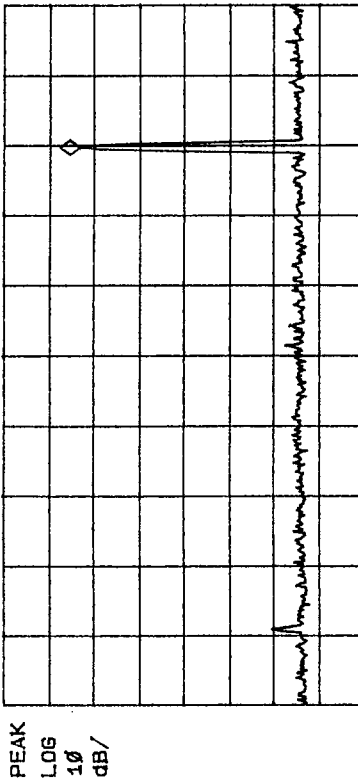

MEASUREMENT

- ① VC03 - 6
- ② AC

Marker	Trace Type	Freq / Time	Amplitude
1:	(A) Freq	1298 MHz	-6.88 dBm
2:	Inactive		
3:	Inactive		
4:	Inactive		

CENTER 1.000 GHz
 RES BW 3.0 MHz VBW 1 MHz SPAN 1.000 GHz
 SWP 20.0 msec

674.700 MHz FM

15: 27: 30 SEP 06, 1997
 FIRST LOCAL FILTER-A PLL6 - B
 REF 10.0 dBm AT 20 dB MKR 1.298 GHz
 -15.23 dBm

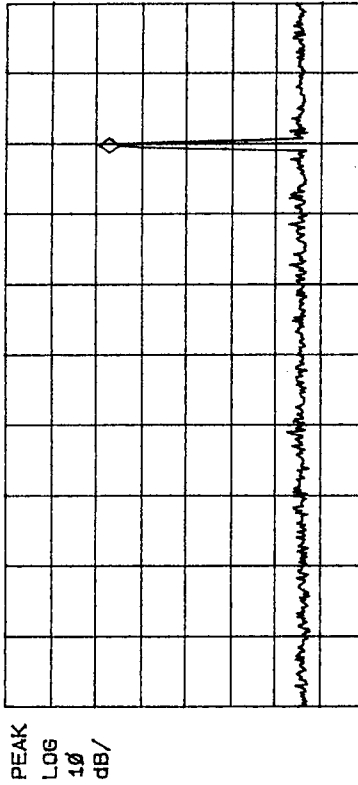

PEAK
 LOG
 10
 dB/

MEASUREMENT

- ① IC10 - 4
- ② AC

Marker	Trace Type	Freq / Time	Amplitude
1:	(A) Freq	1298 MHz	-15.23 dBm
2:	Inactive		
3:	Inactive		
4:	Inactive		

CENTER 1.000 GHz
 RES BW 3.0 MHz VBW 1 MHz SPAN 1.000 GHz
 SWP 20.0 msec

674.700 MHz FM

15: 29: 29 SEP 06, 1997
 FIRST LOCAL FILTER-A PLL6 - C
 REF 10.0 dBm AT 20 dB MKR 1.298 GHz
 -11.95 dBm

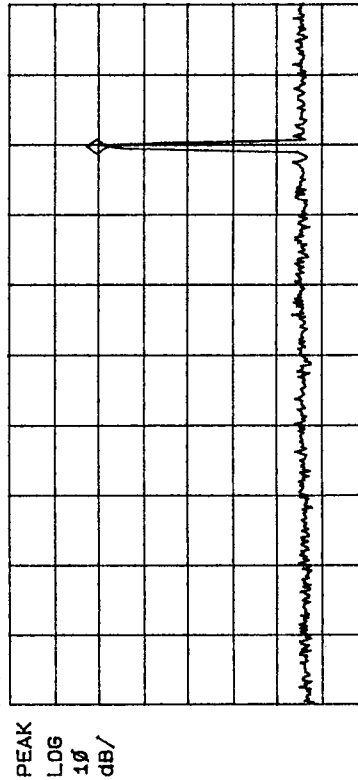

PEAK
 LOG
 10
 dB/

MEASUREMENT

- ① IC10 - 2
- ② AC

Marker	Trace Type	Freq / Time	Amplitude
1:	(A) Freq	1298 MHz	-11.95 dBm
2:	Inactive		
3:	Inactive		
4:	Inactive		

CENTER 1.000 GHz
 RES BW 3.0 MHz VBW 1 MHz SPAN 1.000 GHz
 SWP 20.0 msec

674.700 MHz FM

15: 31: 13 SEP 06, 1997
 FIRST LOCAL FILTER-A PLL6 - D
 REF 10.0 dBm AT 20 dB MKR 1.298 GHz
 -5.73 dBm

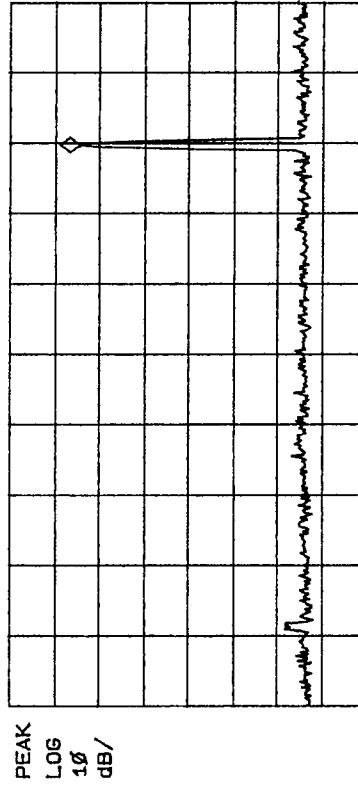

PEAK
 LOG
 10
 dB/

MEASUREMENT

- ① IC1 - 8
- ② AC

Marker	Trace Type	Freq / Time	Amplitude
1:	(A) Freq	1298 MHz	-5.73 dBm
2:	Inactive		
3:	Inactive		
4:	Inactive		

CENTER 1.000 GHz
 RES BW 3.0 MHz VBW 1 MHz SPAN 1.000 GHz
 SWP 20.0 msec

674.700 MHz FM

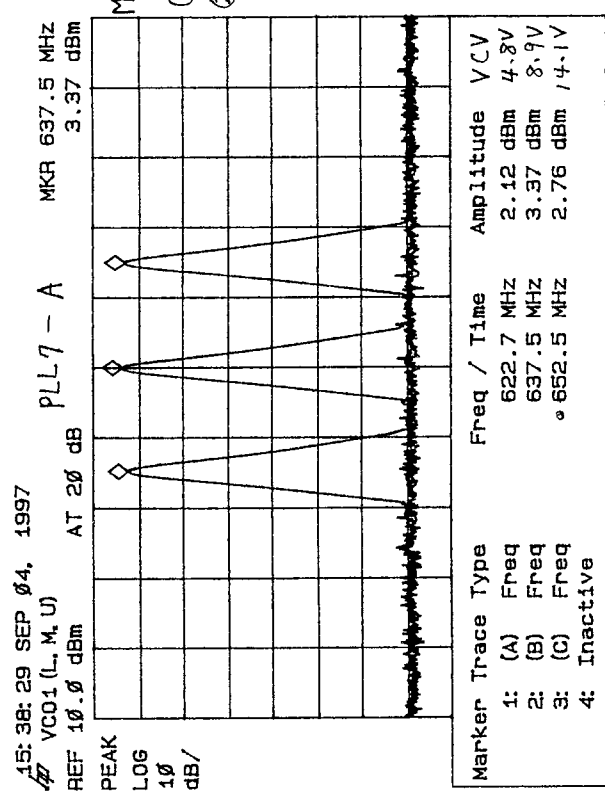

CENTER 637.5 MHz
 RES BW 1.0 MHz
 VBW 300 kHz
 SPAN 100.0 MHz
 SWP 20.0 msec

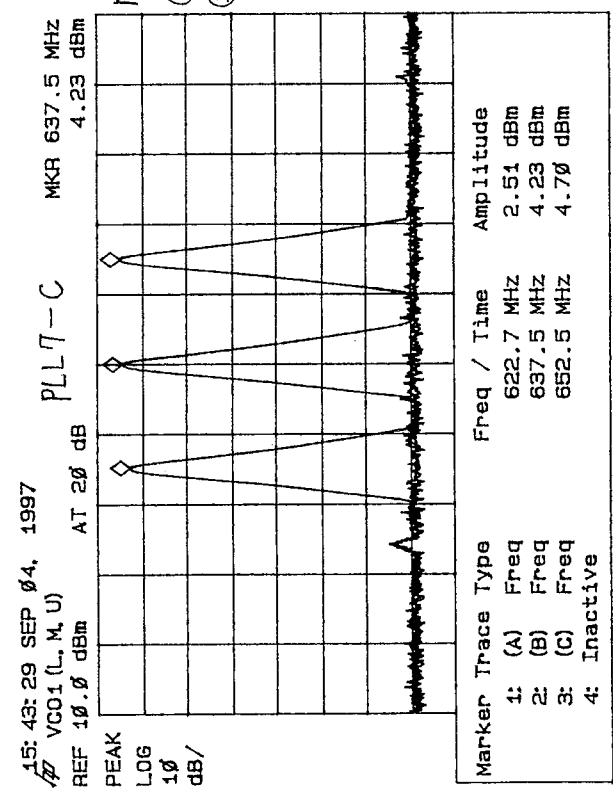

CENTER 637.5 MHz
 RES BW 1.0 MHz
 VBW 300 kHz
 SPAN 100.0 MHz
 SWP 20.0 msec

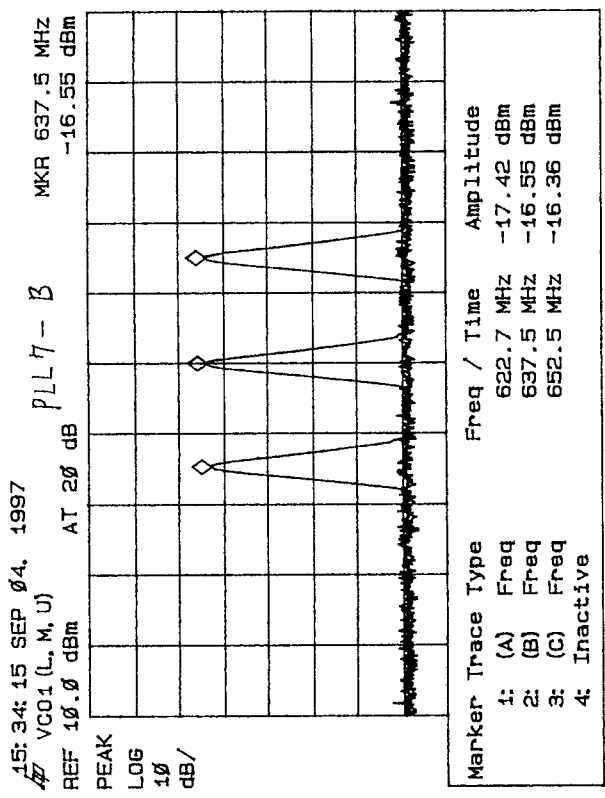

CENTER 637.5 MHz
 RES BW 1.0 MHz
 VBW 300 kHz
 SPAN 100.0 MHz
 SWP 20.0 msec

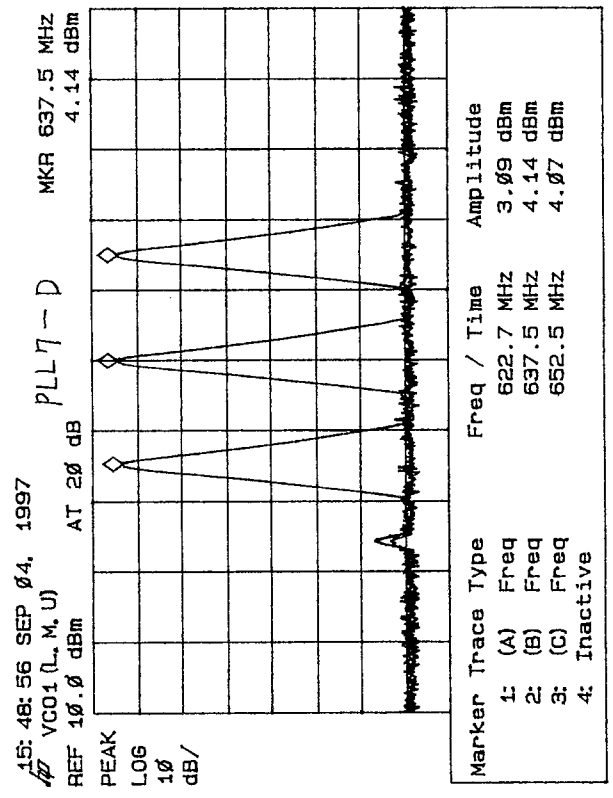

CENTER 637.5 MHz
 RES BW 1.0 MHz
 VBW 300 kHz
 SPAN 100.0 MHz
 SWP 20.0 msec

FILTER-B

19: 29: 07 SEP 04, 1997
VC02-1 (L, M, U)

PLL8 - A

MKR 726.0 MHz
-1.14 dBm

REF 10.0 dBm AT 20 dB

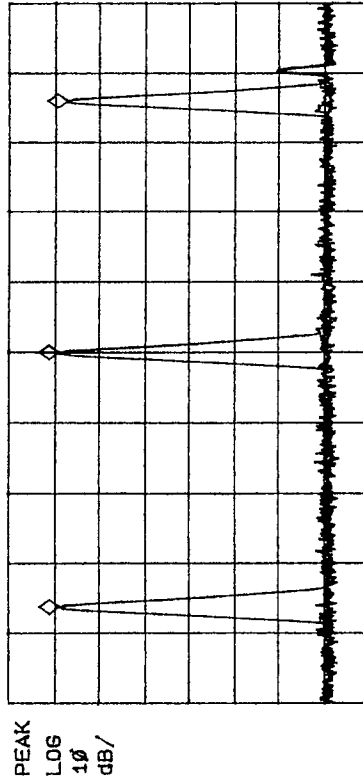

MEASUREMENT

- ① VC02-5
- ② AC

Marker	Trace Type	Freq / Time	Amplitude
1:	(A) Freq	653.5 MHz	-1.28 dBm
2:	(B) Freq	726.0 MHz	-1.14 dBm
3:	(C) Freq	798.0 MHz	-3.01 dBm
4:	Inactive		

CENTER 726.0 MHz
RES BW 1.0 MHz
SPAN 200.0 MHz
SWP 20.0 msec
VBW 300 kHz

19: 41: 54 SEP 04, 1997
VC02-1 (L, M, U)

PLL8 - B

MKR 726.0 MHz
-15.41 dBm

REF 10.0 dBm AT 20 dB

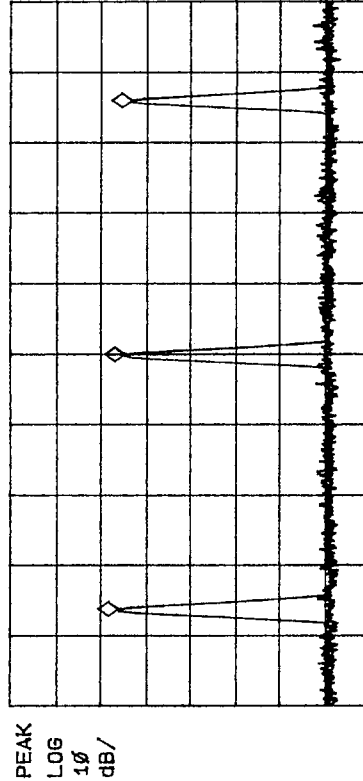

MEASUREMENT

- ① IC9-1
- ② AC

Marker	Trace Type	Freq / Time	Amplitude
1:	(A) Freq	653.5 MHz	-13.98 dBm
2:	(B) Freq	726.0 MHz	-15.41 dBm
3:	(C) Freq	798.0 MHz	-16.93 dBm
4:	Inactive		

CENTER 726.0 MHz
RES BW 1.0 MHz
SPAN 200.0 MHz
SWP 20.0 msec
VBW 300 kHz

FILTER - B

19: 46: 22 SEP 04, 1997
VC02-1 (L, M, U)

PLL8 - C

MKR 726.0 MHz
5.30 dBm

REF 10.0 dBm AT 20 dB

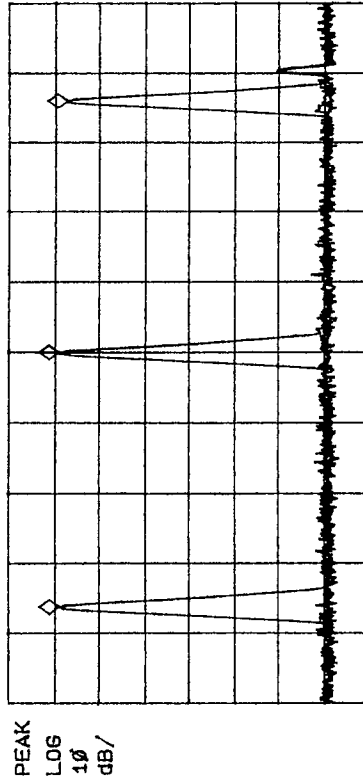

MEASUREMENT

- ① IC9-4
- ② AC

Marker	Trace Type	Freq / Time	Amplitude
1:	(A) Freq	653.5 MHz	5.64 dBm
2:	(B) Freq	726.0 MHz	5.30 dBm
3:	(C) Freq	798.0 MHz	-1.19 dBm
4:	Inactive		

CENTER 726.0 MHz
RES BW 1.0 MHz
SPAN 200.0 MHz
SWP 20.0 msec
VBW 300 kHz

19: 49: 21 SEP 04, 1997
VC02-1 (L, M, U)

PLL8 - D

MKR 726.0 MHz
6.35 dBm

REF 10.0 dBm AT 20 dB

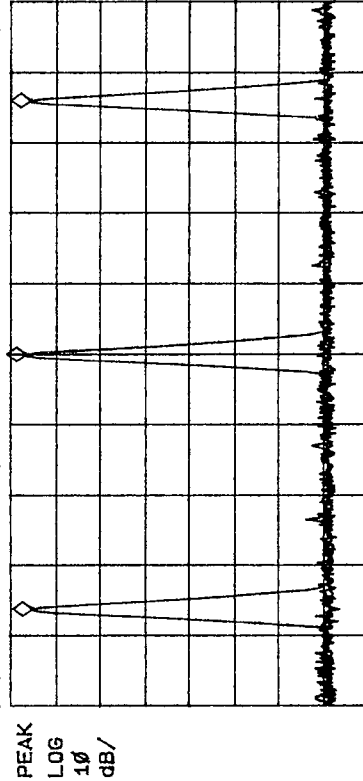

MEASUREMENT

- ① J1
- ② AC

Marker	Trace Type	Freq / Time	Amplitude
1:	(A) Freq	653.5 MHz	4.95 dBm
2:	(B) Freq	726.0 MHz	6.35 dBm
3:	(C) Freq	798.0 MHz	5.44 dBm
4:	Inactive		

CENTER 726.0 MHz
RES BW 1.0 MHz
SPAN 200.0 MHz
SWP 20.0 msec
VBW 300 kHz

20: 04: 29 SEP 04, 1997
VC02-2 (L, M, U)
REF 10.0 dBm AT 20 dB

PLL 9 - A
MKR 901.5 MHz
-5.11 dBm

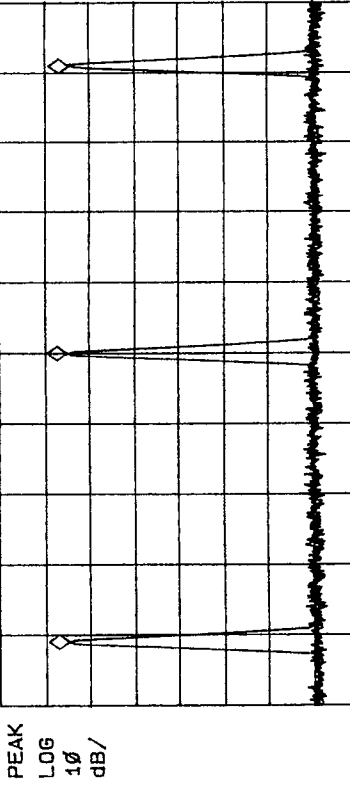

Marker Trace Type	Freq / Time	Amplitude
1: (A) Freq	799.0 MHz	-5.34 dBm 3.0V
2: (B) Freq	901.5 MHz	-5.11 dBm 11.3V
3: (C) Freq	1004.0 MHz	-5.55 dBm 23.0V
4: Inactive		

CENTER 901.5 MHz
#RES BW 1.0 MHz
VBW 300 kHz
SPAN 250.0 MHz
SWP 20.0 msec

MEASUREMENT
① VC02-6
② AC

975.9 MHz FM
1179.9 MHz S
1384.9 MHz S

11: 20: 12 SEP 05, 1997
VC02-2 (L, M, U)
REF 10.0 dBm AT 20 dB

PLL 9 - B
MKR 1.8036 GHz
-13.08 dBm

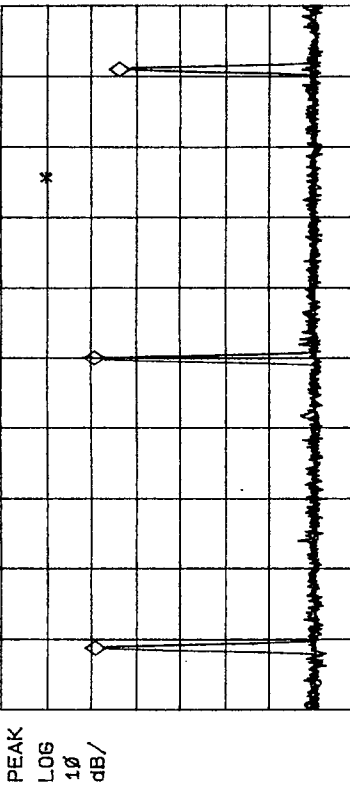

Marker Trace Type	Freq / Time	Amplitude
1: (A) Freq	1597.4 MHz	-13.17 dBm
2: (B) Freq	1803.6 MHz	-13.08 dBm
3: (C) Freq	2008.6 MHz	-18.62 dBm
4: Inactive		

CENTER 1.8036 GHz
#RES BW 1.0 MHz
VBW 300 kHz
SPAN 500.0 MHz
SWP 20.0 msec

MEASUREMENT
① IC11-1
② AC

FILTER - A

11: 26: 36 SEP 05, 1997
VC02-2 (L, M, U)
REF 10.0 dBm AT 20 dB

PLL 9 - C
MKR 1.8036 GHz
3.72 dBm

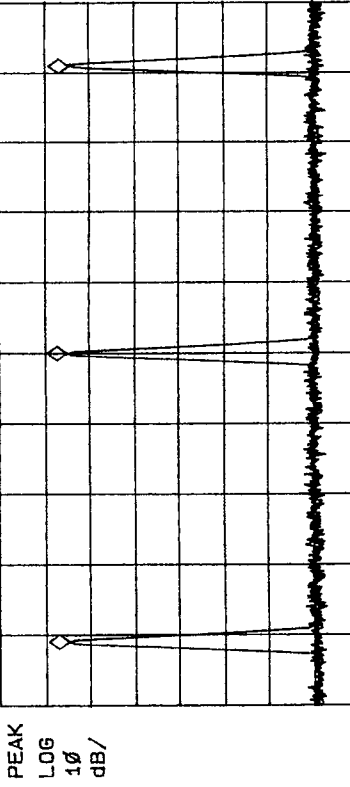

Marker Trace Type	Freq / Time	Amplitude
1: (A) Freq	1597.4 MHz	-0.61 dBm
2: (B) Freq	1803.6 MHz	3.72 dBm
3: (C) Freq	2008.6 MHz	1.33 dBm
4: Inactive		

CENTER 1.8036 GHz
#RES BW 1.0 MHz
VBW 300 kHz
SPAN 500.0 MHz
SWP 20.0 msec

MEASUREMENT
① IC11-4
② AC

11: 40: 39 SEP 05, 1997
VC02-2 (L, M, U)
REF 10.0 dBm AT 20 dB

PLL 9 - D
MKR 1.8036 GHz
-1.81 dBm

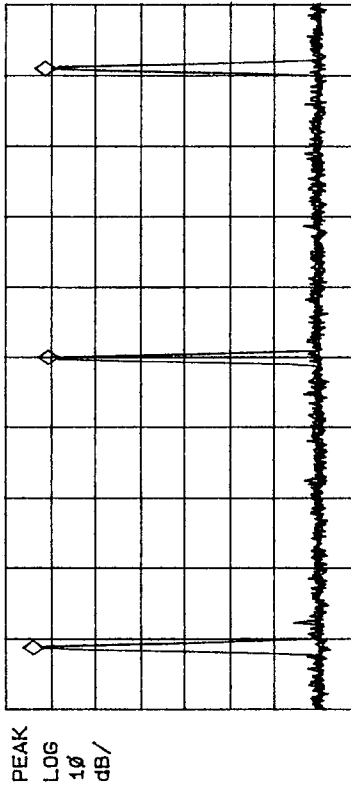

Marker Trace Type	Freq / Time	Amplitude
1: (A) Freq	1597.4 MHz	1.56 dBm
2: (B) Freq	1803.6 MHz	-1.81 dBm
3: (C) Freq	2008.6 MHz	-1.15 dBm
4: Inactive		

CENTER 1.8036 GHz
#RES BW 1.0 MHz
VBW 300 kHz
SPAN 500.0 MHz
SWP 20.0 msec

MEASUREMENT
① J1
② AC

12: 03: 39 SEP 05, 1997
 VC03-1 (L, M, U)
 REF 10.0 dBm AT 20 dB

PLL10 - A MKR 1.0428 GHz
 -5.73 dBm

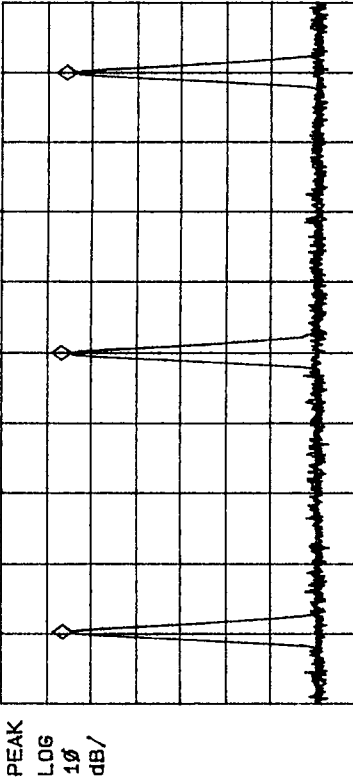

MEASUREMENT
 ① VC03-5
 ② AC

Marker Trace Type	Freq / Time	Amplitude
1: (A) Freq	963.3 MHz	-6.06 dBm 5.4V
2: (B) Freq	1042.8 MHz	-5.73 dBm 10.6V
3: (C) Freq	1122.8 MHz	-6.72 dBm 15.2V
4: Inactive		

CENTER 1.0428 GHz SPAN 200.0 MHz
 #RES BW 1.0 MHz VBW 300 kHz SWP 20.0 msec

340.9 MHz FM
 419.9 MHz "
 499.9 MHz "

12: 10: 52 SEP 05, 1997
 VC03-1 (L, M, U)
 REF 10.0 dBm AT 20 dB

PLL10 - B MKR 1.0428 GHz
 -17.04 dBm

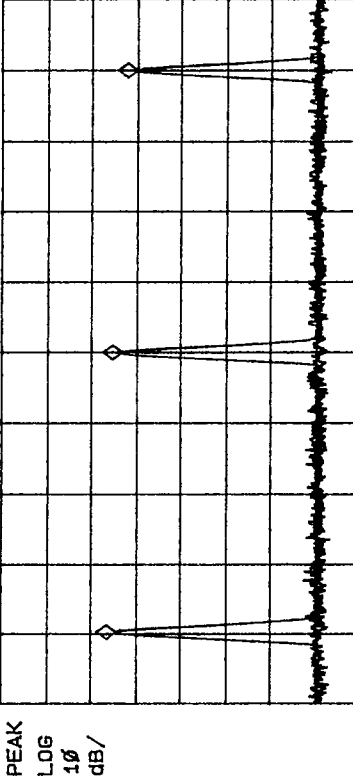

MEASUREMENT
 ① IC12-1
 ② AC

Marker Trace Type	Freq / Time	Amplitude
1: (A) Freq	963.3 MHz	-15.81 dBm
2: (B) Freq	1042.8 MHz	-17.04 dBm
3: (C) Freq	1122.8 MHz	-20.26 dBm
4: Inactive		

CENTER 1.0428 GHz SPAN 200.0 MHz
 #RES BW 1.0 MHz VBW 300 kHz SWP 20.0 msec

13: 23: 01 SEP 05, 1997
 VC03-1 (L, M, U)
 REF 10.0 dBm AT 20 dB

PLL10 - C MKR 1.0423 GHz
 5.42 dBm

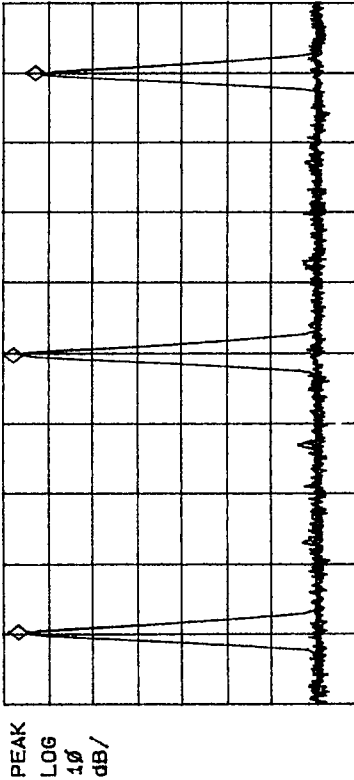

MEASUREMENT
 ① IC12-4
 ② AC

Marker Trace Type	Freq / Time	Amplitude
1: (A) Freq	963.3 MHz	4.35 dBm
2: (B) Freq	1042.3 MHz	5.42 dBm
3: (C) Freq	1122.8 MHz	0.52 dBm
4: Inactive		

CENTER 1.0428 GHz SPAN 200.0 MHz
 #RES BW 1.0 MHz VBW 300 kHz SWP 20.0 msec

FILTER-C

13: 27: 02 SEP 05, 1997
 VC03-1 (L, M, U)
 REF 10.0 dBm AT 20 dB

PLL10 - D MKR 1.0428 GHz
 4.02 dBm

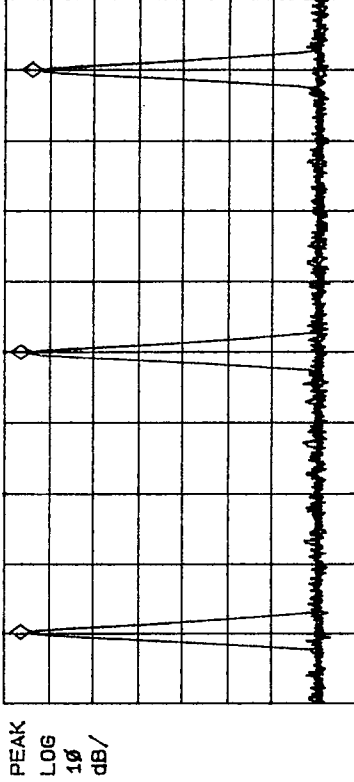

MEASUREMENT
 ① J1
 ② AC

Marker Trace Type	Freq / Time	Amplitude
1: (A) Freq	963.3 MHz	3.89 dBm
2: (B) Freq	1042.8 MHz	4.02 dBm
3: (C) Freq	1122.8 MHz	1.54 dBm
4: Inactive		

CENTER 1.0428 GHz SPAN 200.0 MHz
 #RES BW 1.0 MHz VBW 300 kHz SWP 20.0 msec

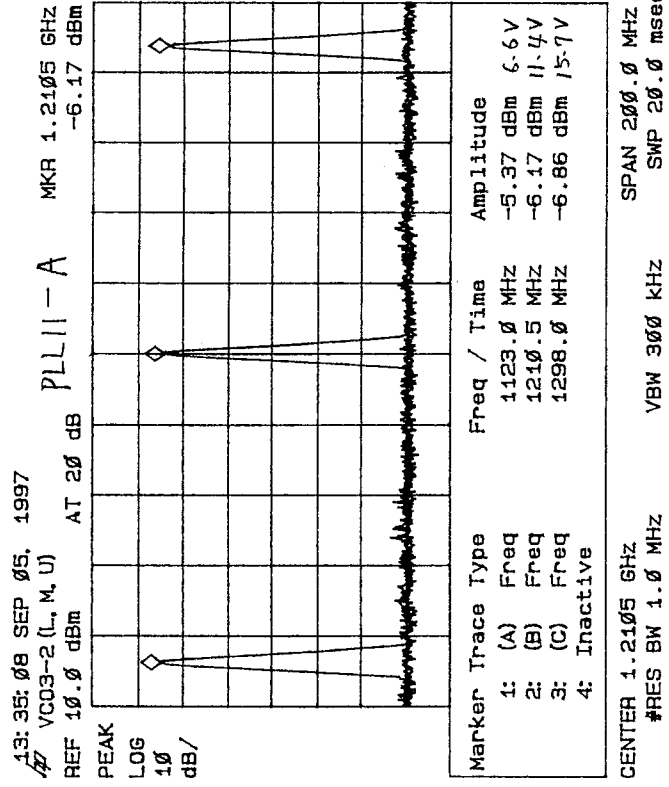

MEASUREMENT
 ① VC03 - 6
 ② AC

500.9 MHz FM
 587.9 MHz ↘
 674.9 MHz ↘

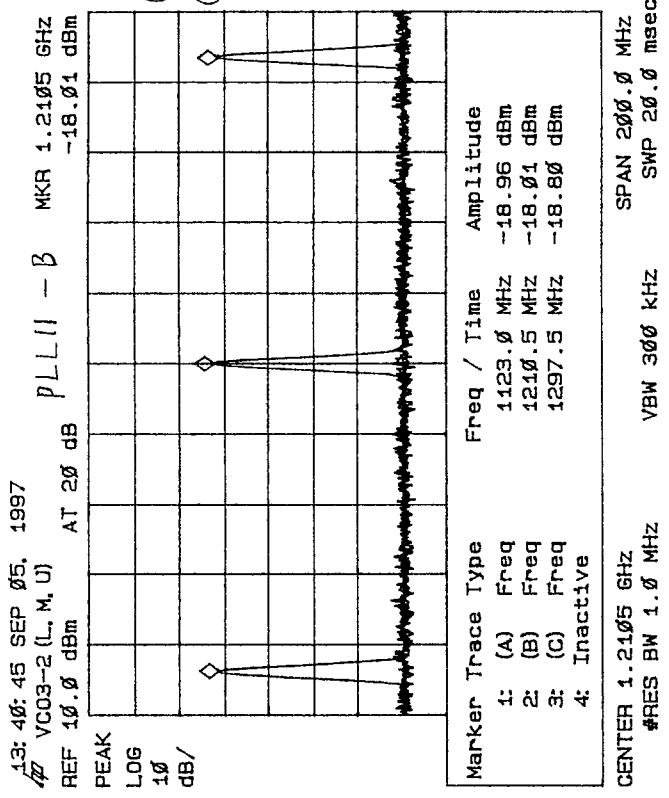

MEASUREMENT
 ① IC12 - 1
 ② AC

FILTER - C

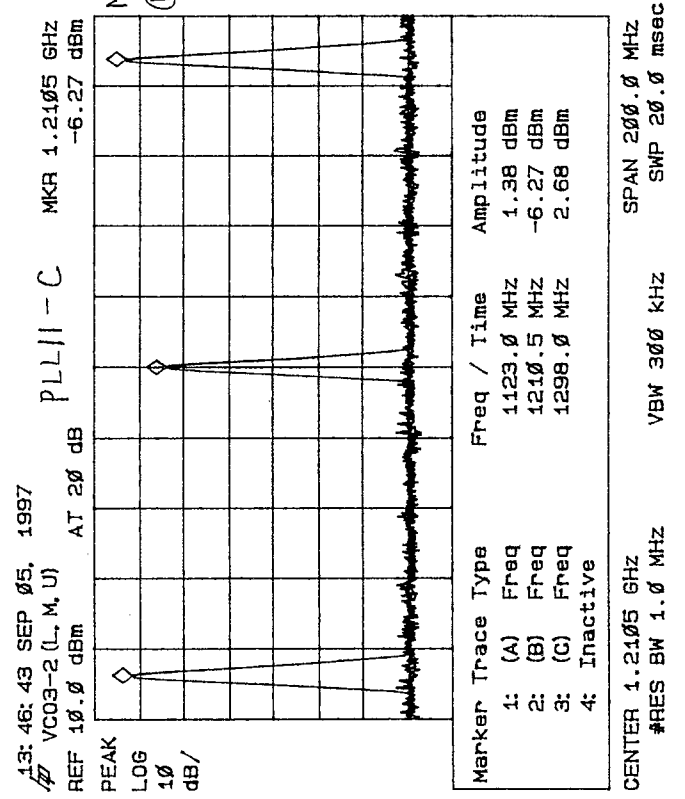

MEASUREMENT
 ① IC12 - 4

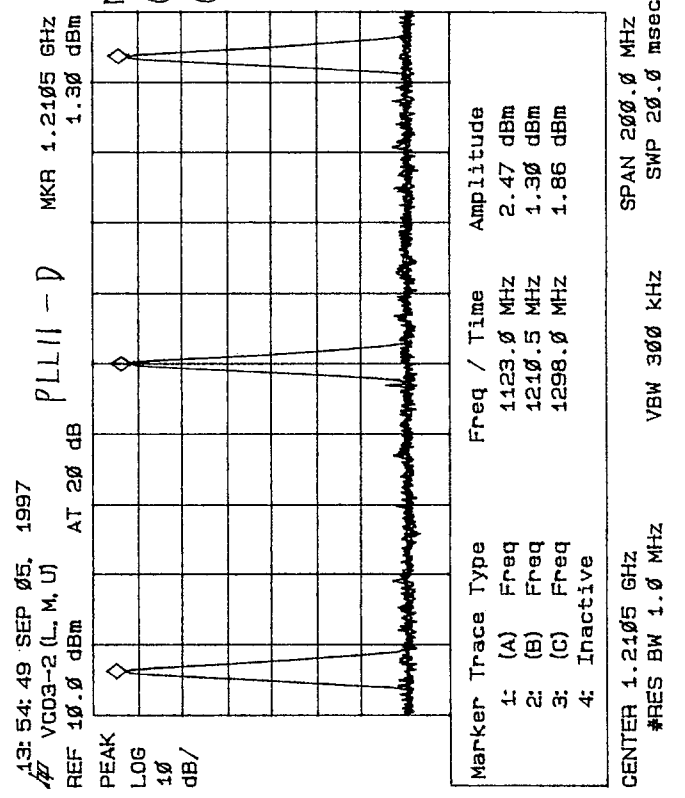

MEASUREMENT
 ① J1
 ② AC

14: 38: 23 SEP 05, 1997
 VC02-1 (L, M, U)
 REF 10.0 dBm AT 20 dB

PLL12-A
 MKR 724.0 MHz
 -1.04 dBm

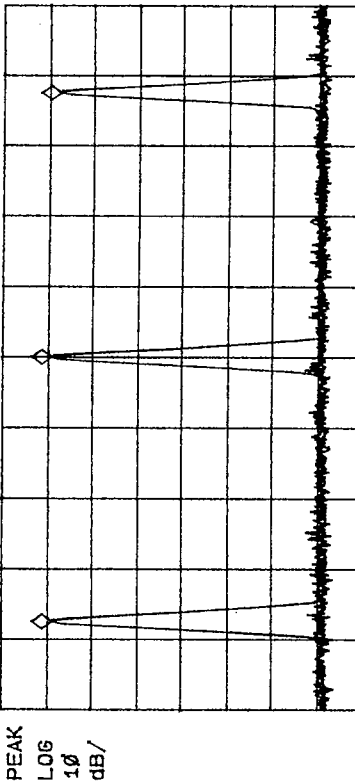

Marker Trace Type	Freq / Time	Amplitude
1: (A) Freq	649.0 MHz	-1.31 dBm
2: (B) Freq	724.0 MHz	-1.04 dBm
3: (C) Freq	799.0 MHz	-2.82 dBm
4: Inactive		

CENTER 724.0 MHz
 #RES BW 1.0 MHz
 VBW 300 kHz
 SPAN 200.0 MHz
 SWP 20.0 msec

MEASUREMENT
 VC02-5
 AC

675.9 MHz FM
 824.9 MHz
 974.9 MHz

14: 29: 06 SEP 05, 1997
 VC02-1 (L, M, U)
 REF 10.0 dBm AT 20 dB

PLL12-B
 MKR 1.4480 GHz
 -10.26 dBm

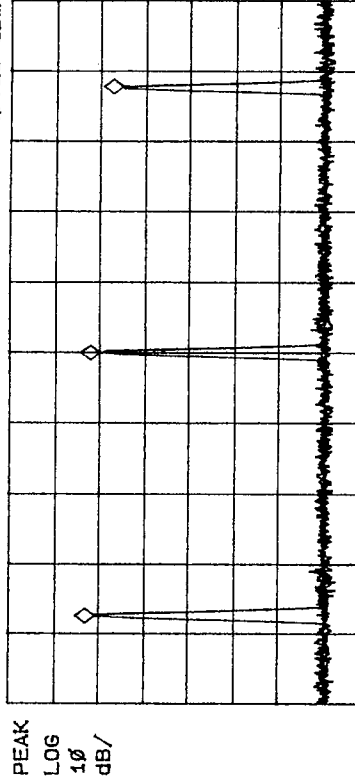

Marker Trace Type	Freq / Time	Amplitude
1: (A) Freq	1298.0 MHz	-9.28 dBm
2: (B) Freq	1448.0 MHz	-10.26 dBm
3: (C) Freq	1599.0 MHz	-15.16 dBm
4: Inactive		

CENTER 1.4480 GHz
 #RES BW 1.0 MHz
 VBW 300 kHz
 SPAN 400.0 MHz
 SWP 20.0 msec

MEASUREMENT
 IC13-1
 AC

14: 32: 43 SEP 05, 1997
 VC02-1 (L, M, U)
 REF 10.0 dBm AT 20 dB

PLL12-C
 MKR 1.4480 GHz
 -3.43 dBm

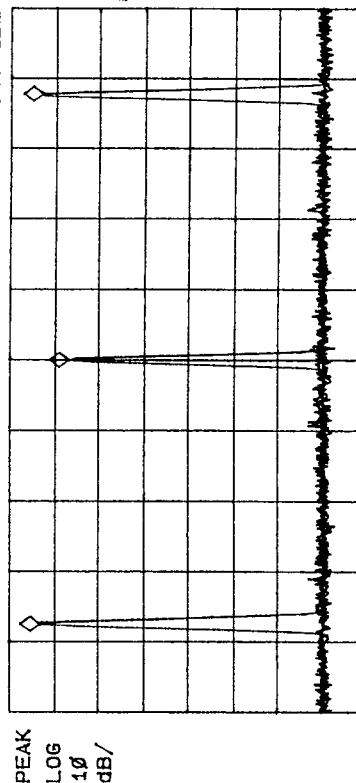

Marker Trace Type	Freq / Time	Amplitude
1: (A) Freq	1298.0 MHz	3.02 dBm
2: (B) Freq	1448.0 MHz	-3.43 dBm
3: (C) Freq	1599.0 MHz	2.65 dBm
4: Inactive		

CENTER 1.4480 GHz
 #RES BW 1.0 MHz
 VBW 300 kHz
 SPAN 400.0 MHz
 SWP 20.0 msec

MEASUREMENT
 IC13-4
 AC

FILTER-E

14: 35: 37 SEP 05, 1997
 VC02-1 (L, M, U)
 REF 10.0 dBm AT 20 dB

PLL12-D
 MKR 1.4480 GHz
 1.83 dBm

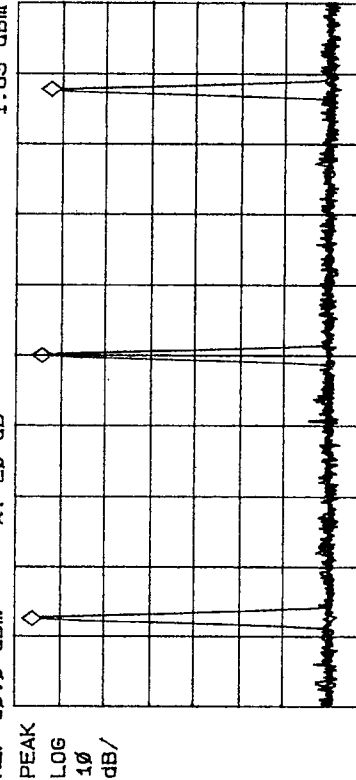

Marker Trace Type	Freq / Time	Amplitude
1: (A) Freq	1298.0 MHz	3.79 dBm
2: (B) Freq	1448.0 MHz	1.83 dBm
3: (C) Freq	1599.0 MHz	-0.03 dBm
4: Inactive		

CENTER 1.4480 GHz
 #RES BW 1.0 MHz
 VBW 300 kHz
 SPAN 400.0 MHz
 SWP 20.0 msec

MEASUREMENT
 J1
 AC

14: 46: 21 SEP 05, 1997
VC02-1 (L, M, U)
REF 10.0 dBm

PLL13 - A
AT 20 dB
MKR 724.0 MHz
-14.63 dBm

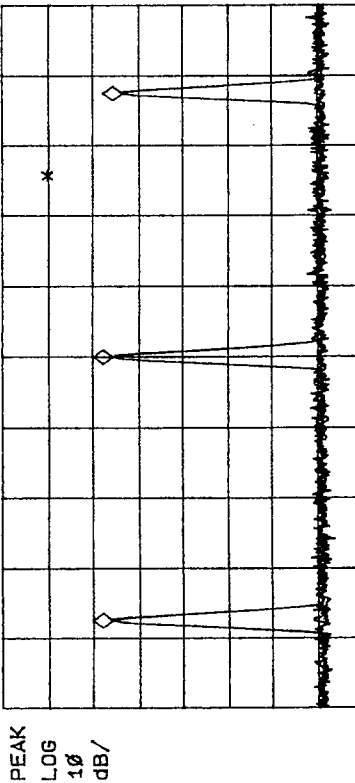

MEASUREMENT
① IC14 - 1
② AC

Marker Trace Type	Freq / Time	Amplitude
1: (A) Freq	649.0 MHz	-14.42 dBm
2: (B) Freq	724.0 MHz	-14.63 dBm
3: (C) Freq	799.0 MHz	-16.77 dBm
4: Inactive		

CENTER 724.0 MHz
#RES BW 1.0 MHz
VBW 300 kHz
SPAN 200.0 MHz
SWP 20.0 msec

14: 49: 58 SEP 05, 1997
VC02-1 (L, M, U)
REF 10.0 dBm

PLL13 - B
AT 20 dB
MKR 724.0 MHz
1.62 dBm

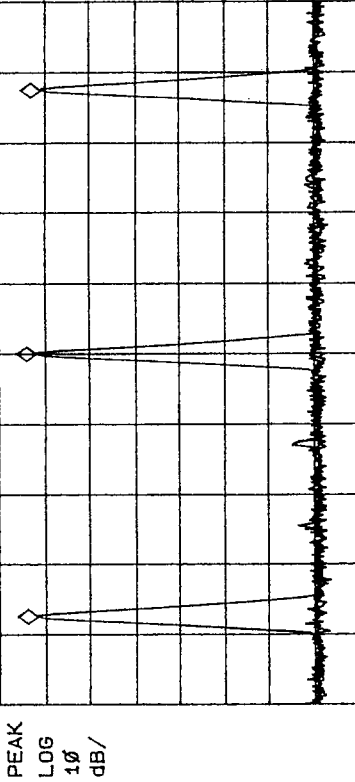

MEASUREMENT
① IC14 - 4
② AC

Marker Trace Type	Freq / Time	Amplitude
1: (A) Freq	649.0 MHz	1.41 dBm
2: (B) Freq	724.0 MHz	1.62 dBm
3: (C) Freq	799.0 MHz	0.63 dBm
4: Inactive		

CENTER 724.0 MHz
#RES BW 1.0 MHz
VBW 300 kHz
SPAN 200.0 MHz
SWP 20.0 msec

14: 53: 08 SEP 05, 1997
VC02-1 (L, M, U)
REF 10.0 dBm

PLL13 - C
AT 20 dB
MKR 724.0 MHz
1.87 dBm

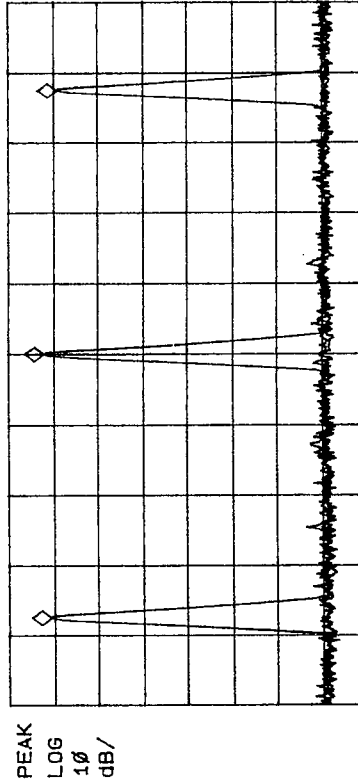

MEASUREMENT
① FDB1 - 3
② AC

Marker Trace Type	Freq / Time	Amplitude
1: (A) Freq	649.0 MHz	0.35 dBm
2: (B) Freq	724.0 MHz	1.87 dBm
3: (C) Freq	799.0 MHz	-1.15 dBm
4: Inactive		

CENTER 724.0 MHz
#RES BW 1.0 MHz
VBW 300 kHz
SPAN 200.0 MHz
SWP 20.0 msec

FILTER - D

14: 57: 14 SEP 05, 1997
VC02-1 (L, M, U)
REF 10.0 dBm

PLL13 - D
AT 20 dB
MKR 1.4480 GHz
-12.00 dBm

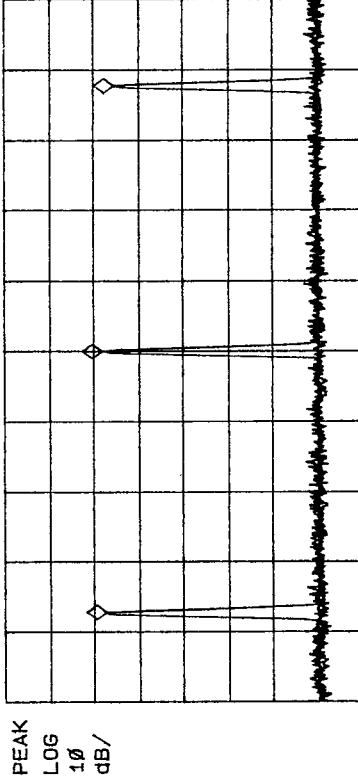

MEASUREMENT
① FDB1 - 1
② AC

Marker Trace Type	Freq / Time	Amplitude
1: (A) Freq	1299.0 MHz	-12.88 dBm
2: (B) Freq	1448.0 MHz	-12.00 dBm
3: (C) Freq	1599.0 MHz	-14.72 dBm
4: Inactive		

CENTER 1.4480 GHz
#RES BW 1.0 MHz
VBW 300 kHz
SPAN 400.0 MHz
SWP 20.0 msec

18: 23: 29 SEP 06, 1997

FIRST LOCAL OUT FILTER-B PLL14 - A MKR 792.3 MHz
REF 10.0 dBm AT 20 dB

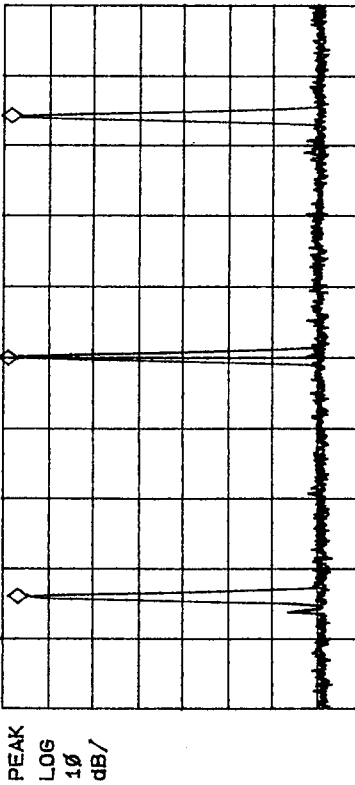

MEASUREMENT
① J1
② DCI

Marker	Trace Type	Freq / Time	Amplitude
1:	(A) Freq	622.3 MHz	4.28 dBm
2:	(B) Freq	792.3 MHz	6.60 dBm
3:	(C) Freq	963.6 MHz	5.94 dBm
4:	Inactive		

CENTER 792.3 MHz
#RES BW 1.0 MHz VBW 300 kHz SPAN 500.0 MHz
SWP 20.0 msec

18: 31: 01 SEP 06, 1997

FIRST LOCAL OUT FILTER-C PLL14 - B MKR 1.1313 GHz
REF 10.0 dBm AT 20 dB

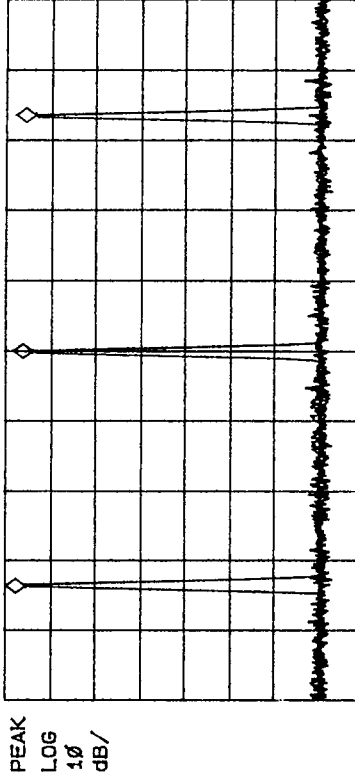

MEASUREMENT
① J1
② DCI

Marker	Trace Type	Freq / Time	Amplitude
1:	(A) Freq	962.5 MHz	5.36 dBm
2:	(B) Freq	1131.3 MHz	3.82 dBm
3:	(C) Freq	1298.8 MHz	3.26 dBm
4:	Inactive		

CENTER 1.1313 GHz
#RES BW 1.0 MHz VBW 300 kHz SPAN 500.0 MHz
SWP 20.0 msec

18: 34: 51 SEP 06, 1997

FIRST LOCAL OUT FILTER-E PLL14 - C MKR 1.4472 GHz
REF 10.0 dBm AT 20 dB

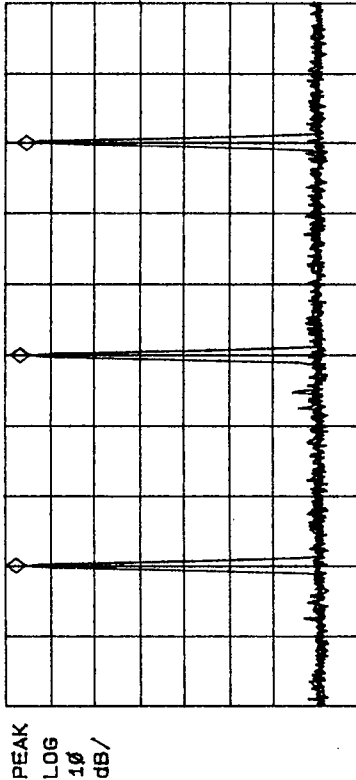

MEASUREMENT
① J1
② DCI

Marker	Trace Type	Freq / Time	Amplitude
1:	(A) Freq	1297.2 MHz	5.95 dBm
2:	(B) Freq	1447.2 MHz	4.39 dBm
3:	(C) Freq	1597.2 MHz	3.00 dBm
4:	Inactive		

CENTER 1.4472 GHz
#RES BW 1.0 MHz VBW 300 kHz SPAN 500.0 MHz
SWP 20.0 msec

18: 39: 09 SEP 06, 1997

FIRST LOCAL OUT FILTER-F PLL14 - D MKR 1.8103 GHz
REF 10.0 dBm AT 20 dB

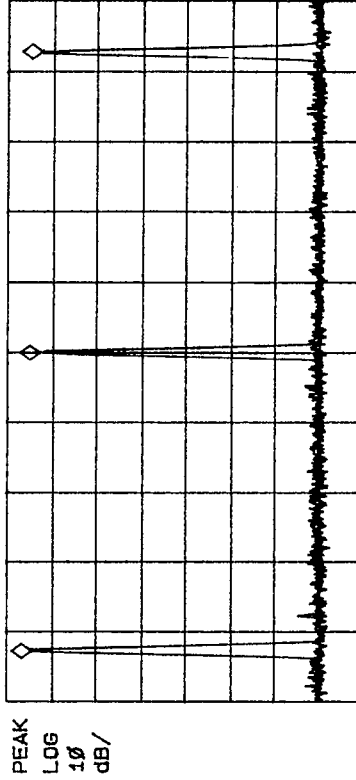

MEASUREMENT
① J1
② DCI

Marker	Trace Type	Freq / Time	Amplitude
1:	(A) Freq	1596.6 MHz	4.37 dBm
2:	(B) Freq	1810.3 MHz	2.67 dBm
3:	(C) Freq	2024.1 MHz	2.32 dBm
4:	Inactive		

CENTER 1.8103 GHz
#RES BW 1.0 MHz VBW 300 kHz SPAN 500.0 MHz
SWP 20.0 msec

OK

17: 05: 22 SEP 06, 1997
 #7 SECOND LOCAL FILTER-6 PLL15-A MKR 611.710 MHz
 REF 10.0 dBm AT 20 dB

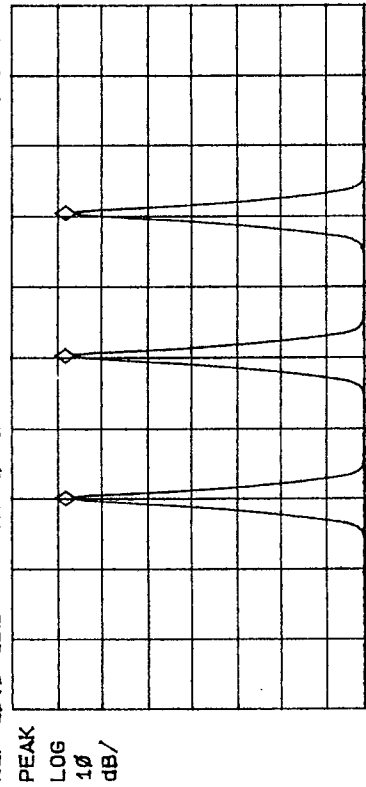

MEASUREMENT
 ① VC04-4
 ② AC

Marker	Trace Type	Freq / Time	Amplitude
1:	(A) Freq	610.900 MHz	-4.24 dBm 2.3V
2:	(A) Freq	611.305 MHz	-4.24 dBm 2.6V
3:	(A) Freq	611.710 MHz	-4.27 dBm 2.8V
4:	Inactive		

CENTER 611.300 MHz SPAN 2.000 MHz
 #RES BW 10 KHZ VBW 10 KHZ SWP 60.0 msec

1480.0 MHz FM
 5.8 MHz
 129.9 MHz

17: 13: 09 SEP 06, 1997
 #7 SECOND LOCAL FILTER-6 PLL15-B MKR 610 MHz
 REF 10.0 dBm AT 20 dB

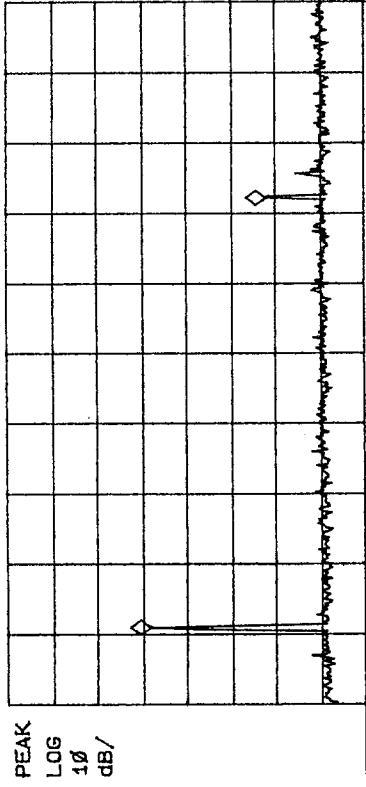

MEASUREMENT
 ① IC6-1
 ② AC

Marker	Trace Type	Freq / Time	Amplitude
1:	(A) Freq	610 MHz	-21.86 dBm
2:	(A) Freq	1223 MHz	-47.98 dBm
3:	Inactive		
4:	Inactive		

CENTER 1.000 GHz SPAN 1.000 GHz
 #RES BW 1.0 MHz VBW 300 KHZ SWP 20.0 msec

5.8 MHz FM

17: 15: 15 SEP 06, 1997
 #7 SECOND LOCAL FILTER-6 PLL15-C MKR 610 MHz
 REF 10.0 dBm AT 20 dB

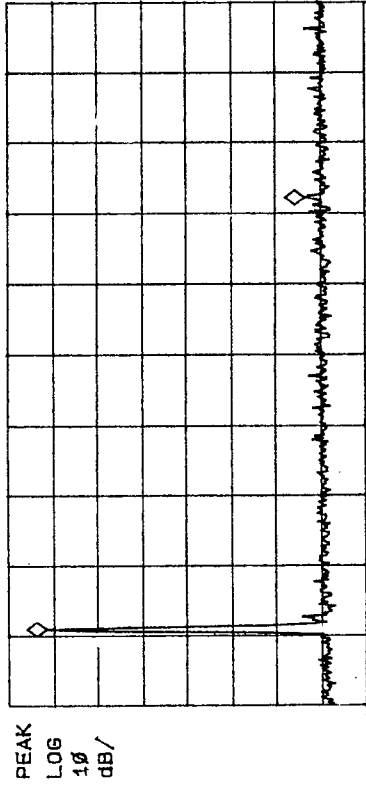

MEASUREMENT
 ① IC6-4
 ② AC

Marker	Trace Type	Freq / Time	Amplitude
1:	(A) Freq	610 MHz	1.35 dBm
2:	(A) Freq	1223 MHz	-56.78 dBm
3:	Inactive		
4:	Inactive		

CENTER 1.000 GHz SPAN 1.000 GHz
 #RES BW 1.0 MHz VBW 300 KHZ SWP 20.0 msec

5.8 MHz FM

17: 18: 03 SEP 06, 1997
 #7 SECOND LOCAL FILTER-6 PLL15-D MKR 610 MHz
 REF 10.0 dBm AT 20 dB

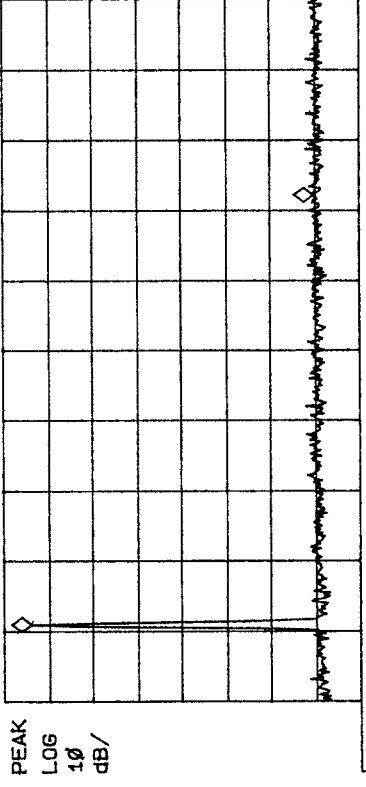

MEASUREMENT
 ① J2
 ② DC2

Marker	Trace Type	Freq / Time	Amplitude
1:	(A) Freq	610 MHz	3.71 dBm
2:	(A) Freq	1223 MHz	-59.98 dBm
3:	Inactive		
4:	Inactive		

CENTER 1.000 GHz SPAN 1.000 GHz
 #RES BW 1.0 MHz VBW 300 KHZ SWP 20.0 msec

5.8 MHz FM

16:20:53 SEP 06, 1997

SECOND LOCAL FILTER-J PLL16-A MKR 5.90 MHz
REF .0 dBm AT 10 dB

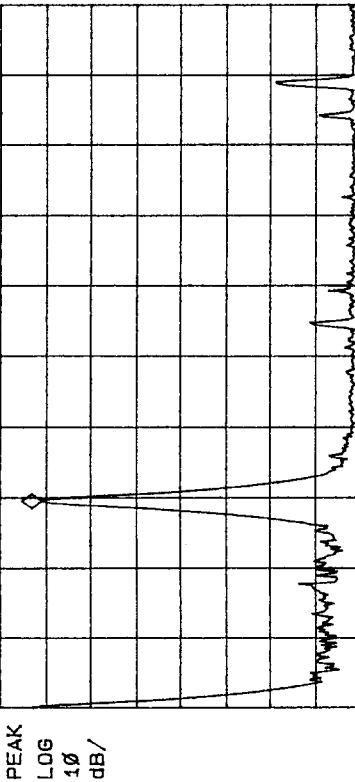

MEASUREMENT

- ① DBM1-1
- ② AC

Marker	Trace Type	Freq / Time	Amplitude
1:	(A) Freq	5.90 MHz	-9.31 dBm
2:	Inactive		
3:	Inactive		
4:	Inactive		

129.9 MHz FM

CENTER 10.00 MHz SPAN 20.00 MHz
#RES BW 100 kHz VBW 30 kHz SWP 20.0 msec

16:27:31 SEP 06, 1997

SECOND LOCAL FILTER-J PLL16-B MKR 617.70 MHz
REF .0 dBm AT 10 dB

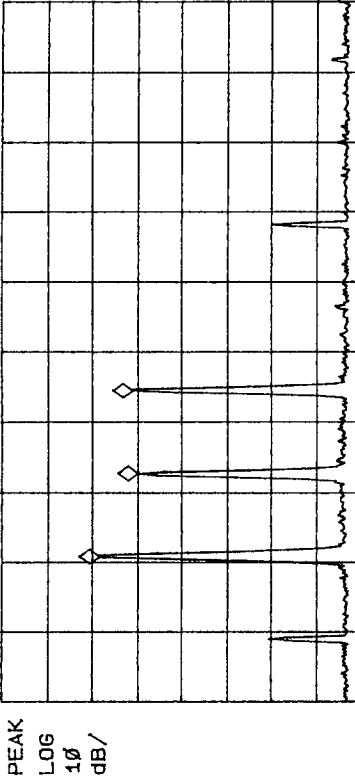

MEASUREMENT

- ① DBM1-2
- ② AC

Marker	Trace Type	Freq / Time	Amplitude
1:	(A) Freq	605.83 MHz	-21.67 dBm
2:	(A) Freq	611.83 MHz	-30.30 dBm
3:	(A) Freq	617.70 MHz	-29.15 dBm
4:	Inactive		

129.9 MHz FM

CENTER 620.45 MHz SPAN 50.00 MHz
#RES BW 100 kHz VBW 30 kHz SWP 50.0 msec

16:30:09 SEP 06, 1997

SECOND LOCAL FILTER-J PLL16-C MKR 647.70 MHz
REF .0 dBm AT 10 dB

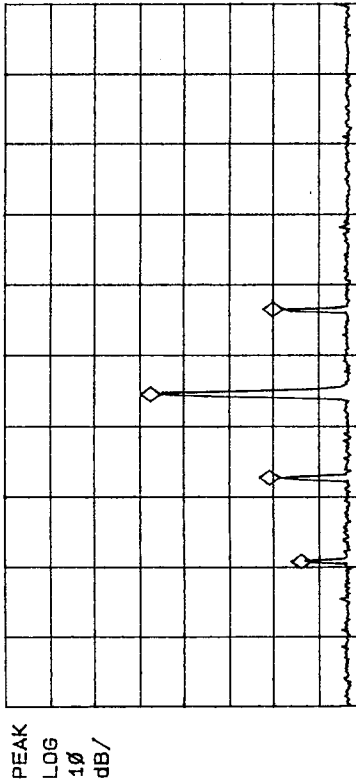

MEASUREMENT

- ① IC8-4
- ② AC

Marker	Trace Type	Freq / Time	Amplitude
1:	(A) Freq	605.83 MHz	-68.50 dBm
2:	(A) Freq	611.83 MHz	-61.50 dBm
3:	(A) Freq	617.70 MHz	-34.87 dBm
4:	(A) Freq	623.70 MHz	-62.31 dBm

129.9 MHz FM

CENTER 620.45 MHz SPAN 50.00 MHz
#RES BW 100 kHz VBW 30 kHz SWP 50.0 msec

16:32:36 SEP 06, 1997

SECOND LOCAL FILTER-J PLL16-D MKR 617.70 MHz
REF .0 dBm AT 10 dB

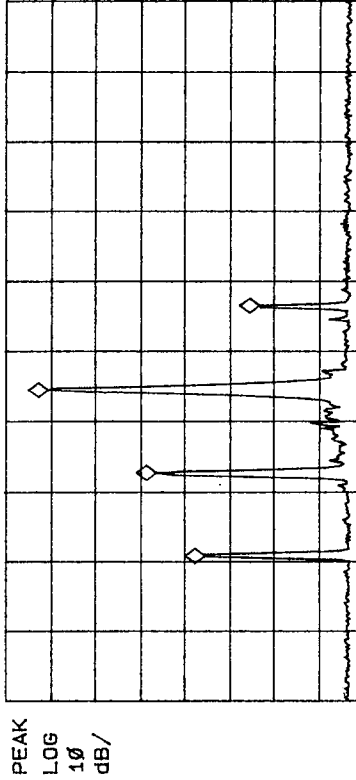

MEASUREMENT

- ① IC8-2
- ② AC

Marker	Trace Type	Freq / Time	Amplitude
1:	(A) Freq	605.83 MHz	-44.62 dBm
2:	(A) Freq	611.83 MHz	-33.73 dBm
3:	(A) Freq	617.70 MHz	-9.57 dBm
4:	(A) Freq	623.70 MHz	-56.87 dBm

129.9 MHz FM

CENTER 620.45 MHz SPAN 50.00 MHz
#RES BW 100 kHz VBW 30 kHz SWP 50.0 msec

16: 38: 06 SEP 06, 1997

SECOND LOCAL FILTER-J PLL17-A
REF .0 dBm AT 10 dB MKR 617.70 MHz
-14.98 dBm

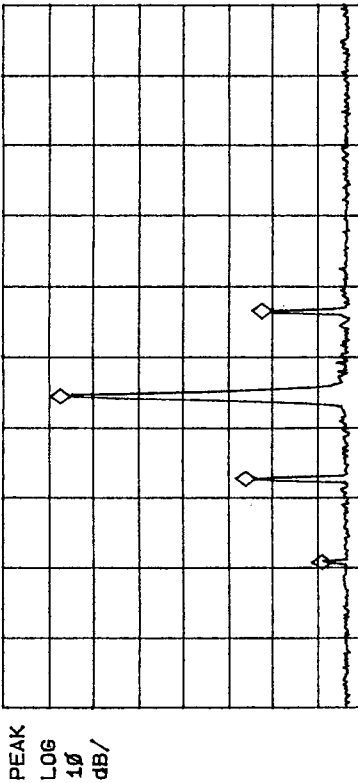

MEASUREMENT

- ① IC3-8
- ② AC

129.9 MHz FM

CENTER 620.45 MHz SPAN 50.00 MHz
#RES BW 100 kHz VBW 30 kHz SWP 50.0 msec

16: 48: 09 SEP 06, 1997

SECOND LOCAL FILTER-H PLL17-C
REF .0 dBm AT 10 dB MKR 611.83 MHz
-3.11 dBm

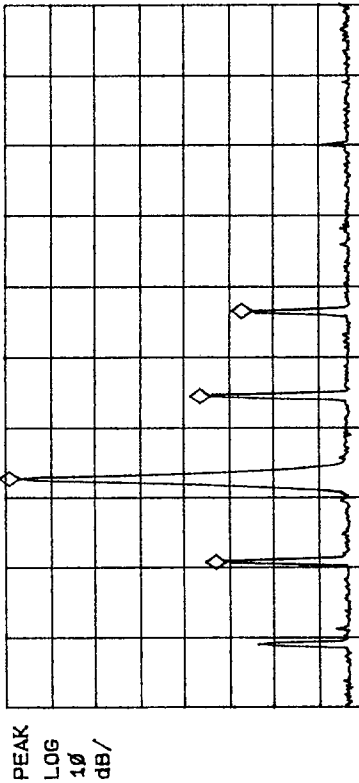

MEASUREMENT

- ① IC7-2
- ② AC

129.9 MHz FM

CENTER 620.45 MHz SPAN 50.00 MHz
#RES BW 100 kHz VBW 30 kHz SWP 50.0 msec

16: 44: 20 SEP 06, 1997

SECOND LOCAL FILTER-H PLL17-B
REF .0 dBm AT 10 dB MKR 611.83 MHz
-9.88 dBm

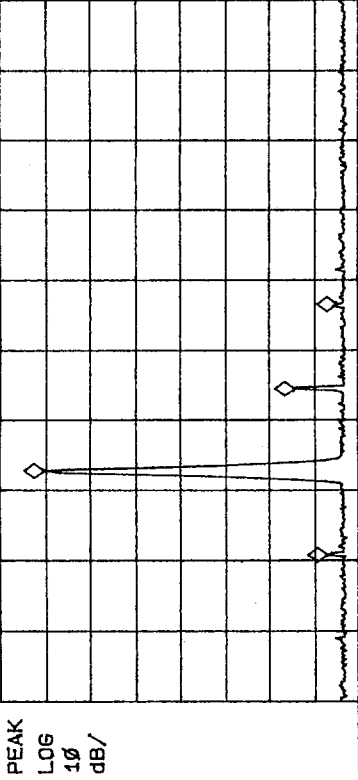

MEASUREMENT

- ① IC7-4
- ② AC

129.9 MHz FM

CENTER 620.45 MHz SPAN 50.00 MHz
#RES BW 100 kHz VBW 30 kHz SWP 50.0 msec

16: 51: 43 SEP 06, 1997

SECOND LOCAL FILTER-H PLL17-D
REF .0 dBm AT 10 dB MKR 611.83 MHz
-3.56 dBm

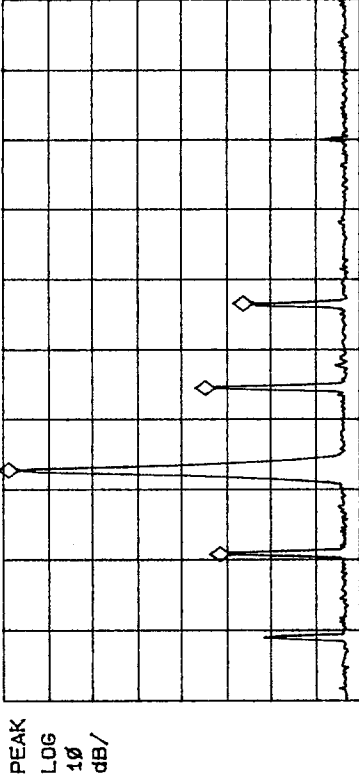

MEASUREMENT

- ① DBM1-3
- ② AC

129.9 MHz FM

CENTER 620.45 MHz SPAN 50.00 MHz
#RES BW 100 kHz VBW 30 kHz SWP 50.0 msec

20:05:27 SEP 05, 1997

SECOND LOCAL FILTER-K PLL18-A MKR 4.70 MHz -2.59 dB

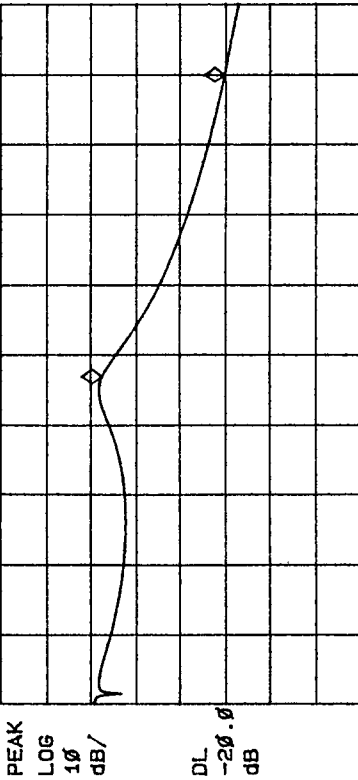

1. IN
 ① R111 → L60
 ② LEVEL -20dBm
 ③ DC
 2. OUT
 ① L61 → R102
 ② DC

* pow OFF
 129.9 MHz CW

Marker	Trace Type	Freq / Time	Amplitude
1:	(A) Freq	4.70 MHz	-2.59dBDL
2:	(A) Freq	9.00 MHz	-30.06dBDL
3:	Inactive		
4:	Inactive		

CENTER 5.00 MHz #RES BW 10 kHz VBW 10 kHz SPAN 10.00 MHz SWP 300 msec

20:08:13 SEP 05, 1997

SECOND LOCAL FILTER-K PLL18-B MKR 4.70 MHz -3.45 dB

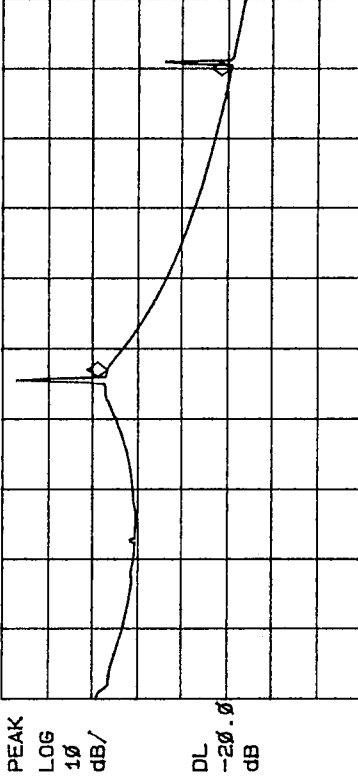

1. IN
 AK同シ
 2. OUT

same as A
 * pow ON
 129.9 MHz CW

Marker	Trace Type	Freq / Time	Amplitude
1:	(A) Freq	4.70 MHz	-3.45dBDL
2:	(A) Freq	9.00 MHz	-30.99dBDL
3:	Inactive		
4:	Inactive		

CENTER 5.00 MHz #RES BW 10 kHz VBW 10 kHz SPAN 10.00 MHz SWP 300 msec

20:21:53 SEP 05, 1997

SECOND LOCAL FILTER-K PLL18-C MKR 4.70 MHz -9.95 dB

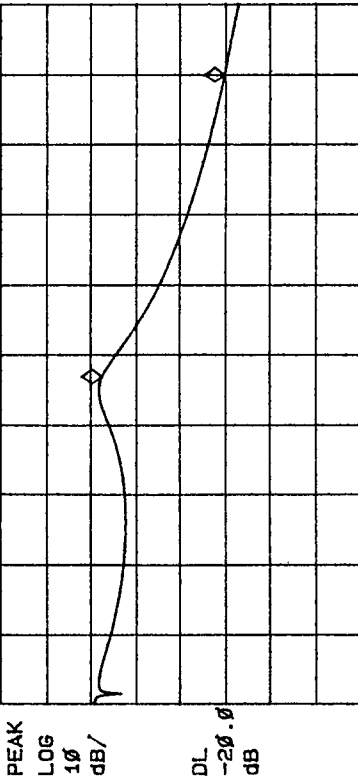

1. IN
 ① R122 → L63
 ② LEVEL -20dBm
 ③ AC 0.1uF
 2. OUT
 ① J3
 ② DC2

129.9 MHz CW

Marker	Trace Type	Freq / Time	Amplitude
1:	(A) Freq	4.70 MHz	-9.95dBDL
2:	(A) Freq	9.00 MHz	-39.29dBDL
3:	Inactive		
4:	Inactive		

CENTER 5.00 MHz #RES BW 10 kHz VBW 10 kHz SPAN 10.00 MHz SWP 300 msec

20:25:49 SEP 05, 1997

SECOND LOCAL FILTER-K PLL18-D MKR 4.70 MHz -9.48 dB

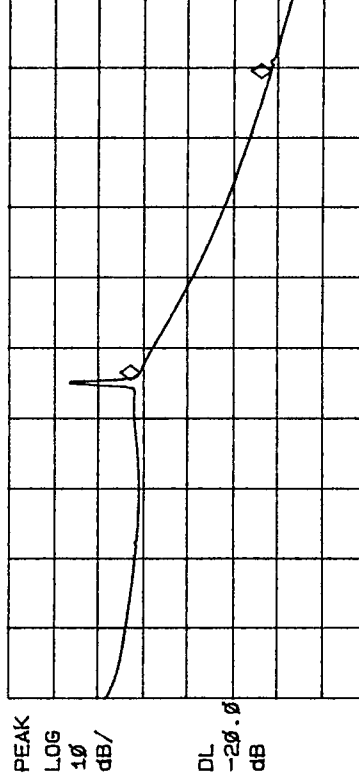

1. IN
 ① R122 → L63
 ② LEVEL -20dBm
 ③ DC
 2. OUT

same as C
 129.9 MHz CW

Marker	Trace Type	Freq / Time	Amplitude
1:	(A) Freq	4.70 MHz	-9.48dBDL
2:	(A) Freq	9.00 MHz	-38.59dBDL
3:	Inactive		
4:	Inactive		

CENTER 5.00 MHz #RES BW 3.0 kHz VBW 3 kHz SPAN 1.00 MHz SWP 333 msec

129.9 MHz CW pitch 1kHz

PLL19

↓ SUBCARRIER 4.54 MHz

09-AUG-1997 15:31

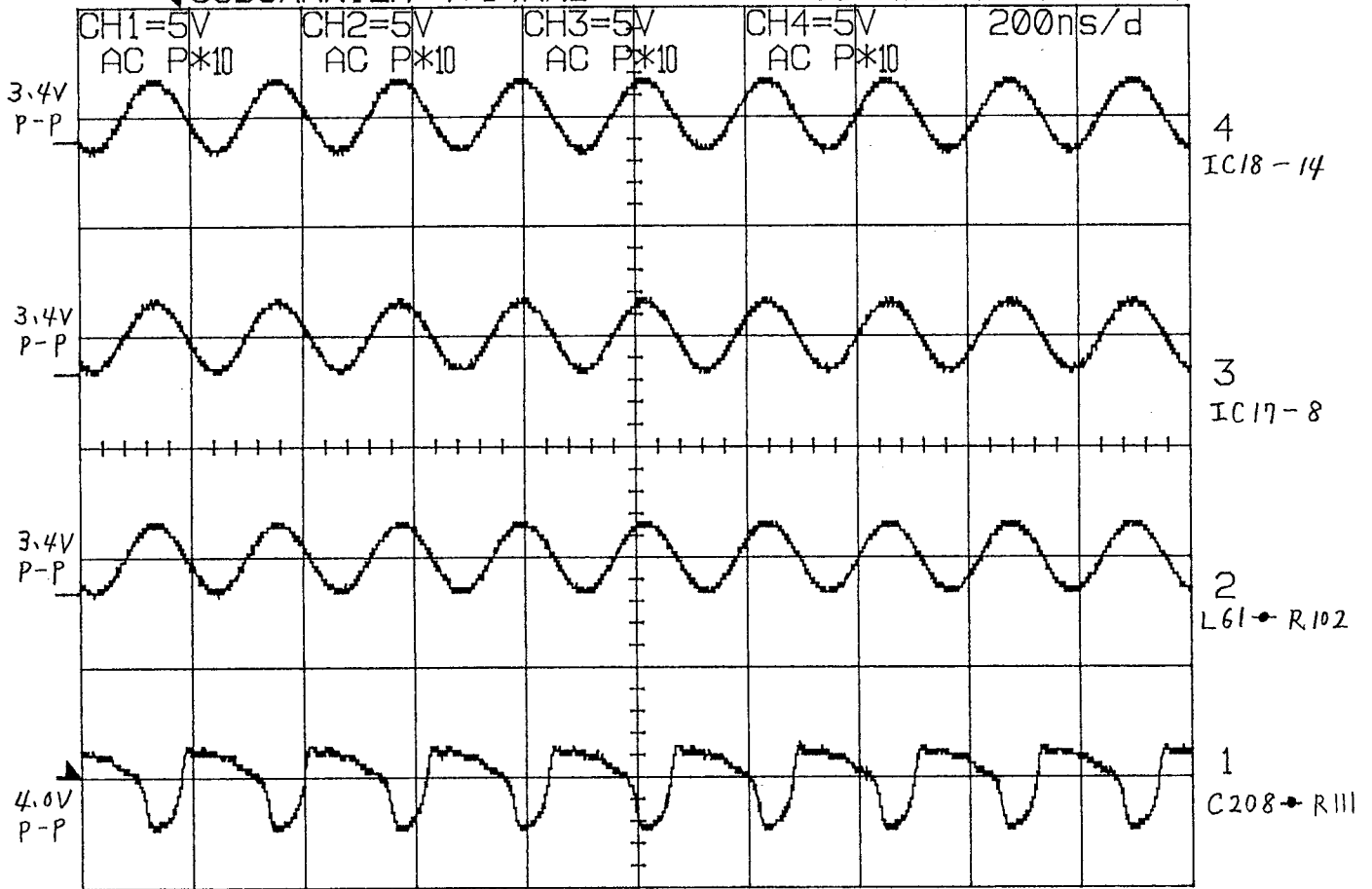

↓ SUBCARRIER 454 KHz

09-AUG-1997 15:25

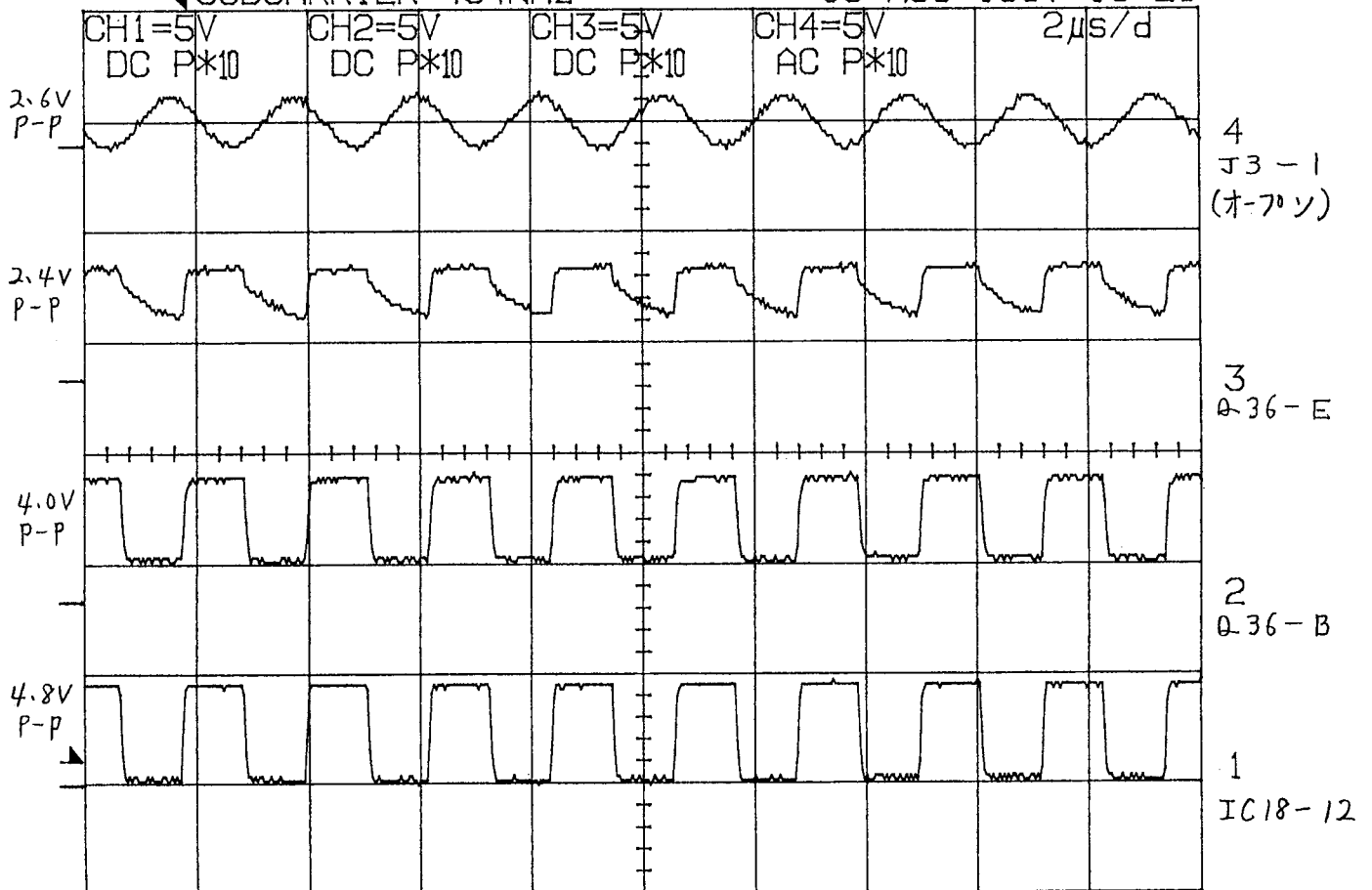

10:22:43 SEP 06, 1997

STD FILTER-M (INT 12.8MHz) PLL20 - A MKR 12.80 MHz
REF .0 dBm AT 10 dB

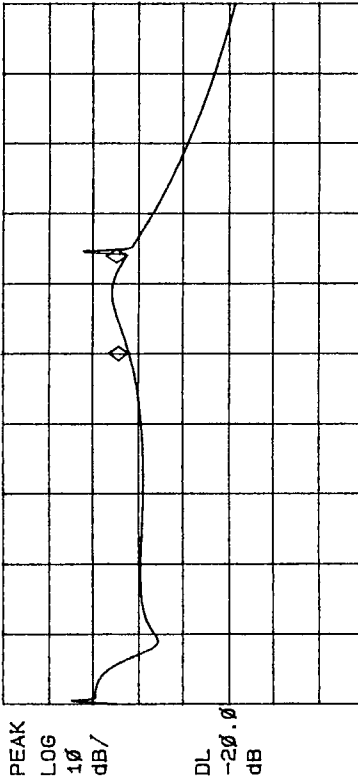

Marker	Trace Type	Freq	Time	Amplitude
1:	(A)	10.00 MHz		-8.03dBm
2:	(A)	12.80 MHz		-7.48dBm
3:	Inactive			
4:	Inactive			

CENTER 10.00 MHz
#RES BW 30 KHz
SPAN 20.00 MHz
SWP 66.7 msec

1, IN
 ① C223 - L65
 ② LEVEL -20dBm
 ③ DC
 2, OUT
 ① L66 - C209
 ② DC
 129.9 MHz FM

10:35:13 SEP 06, 1997

STD FILTER-M/N (EXT 10.0MHz) PLL20 - B MKR 10.00 MHz
REF .0 dBm AT 10 dB

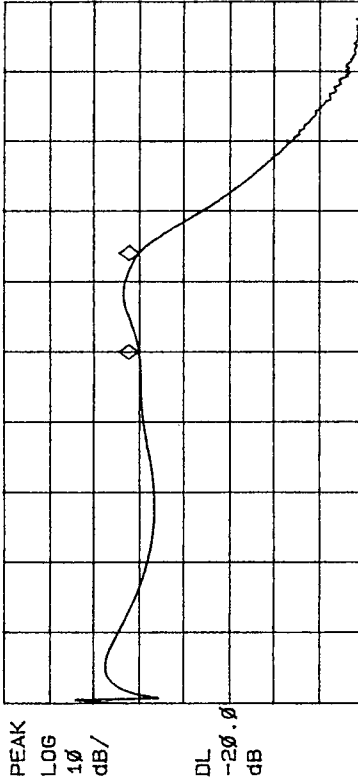

Marker	Trace Type	Freq	Time	Amplitude
1:	(A)	10.00 MHz		-10.03dBm
2:	(A)	12.80 MHz		-10.14dBm
3:	Inactive			
4:	Inactive			

CENTER 10.00 MHz
#RES BW 30 KHz
SPAN 20.00 MHz
SWP 66.7 msec

1, IN
 ① J4
 ② LEVEL -20dBm
 ③ DC2
 2, OUT
 Same as A
 129.9 MHz FM

10:28:33 SEP 06, 1997

STD FILTER-N (EXT 10.0MHz) PLL20 - C MKR 10.00 MHz
REF .0 dBm AT 10 dB

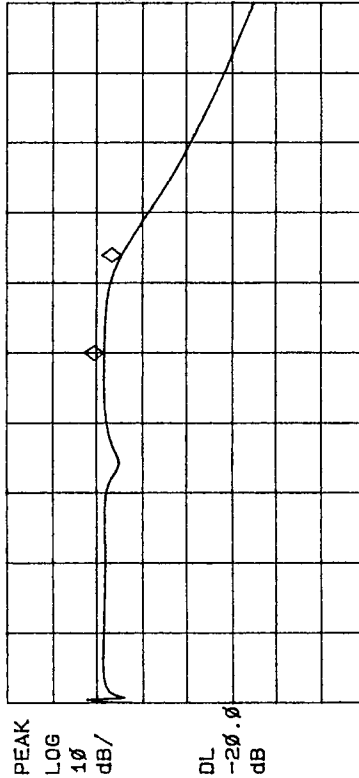

Marker	Trace Type	Freq	Time	Amplitude
1:	(A)	10.00 MHz		-1.68dBm
2:	(A)	12.80 MHz		-5.65dBm
3:	Inactive			
4:	Inactive			

CENTER 10.00 MHz
#RES BW 30 KHz
SPAN 20.00 MHz
SWP 66.7 msec

1, IN
 ① J4
 ② LEVEL -20dBm
 ③ DC2
 2, OUT
 ① L68 - C225
 ② DC
 129.9 MHz FM

10:31:12 SEP 06, 1997

STD FILTER-N (INT 12.8MHz) PLL20 - D MKR 10.00 MHz
REF .0 dBm AT 10 dB

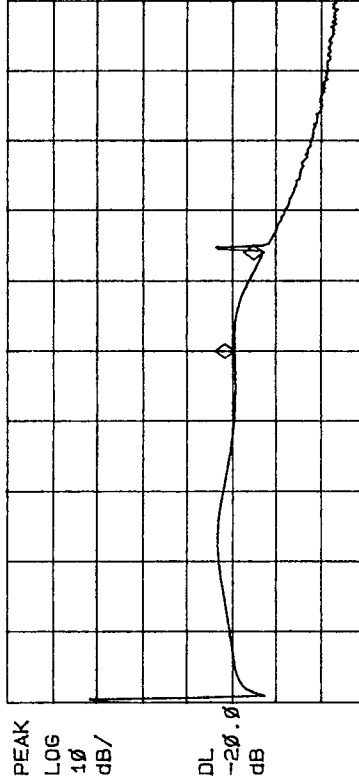

Marker	Trace Type	Freq	Time	Amplitude
1:	(A)	10.00 MHz		-30.81dBm
2:	(A)	12.80 MHz		-37.33dBm
3:	Inactive			
4:	Inactive			

CENTER 10.00 MHz
#RES BW 30 KHz
SPAN 20.00 MHz
SWP 66.7 msec

1, IN
 Same as C
 2, OUT
 Same as C
 129.9 MHz FM

129.9MHz FM

PLL 21

INTERNAL STD 12.8MHz

09-AUG-1997 10:02

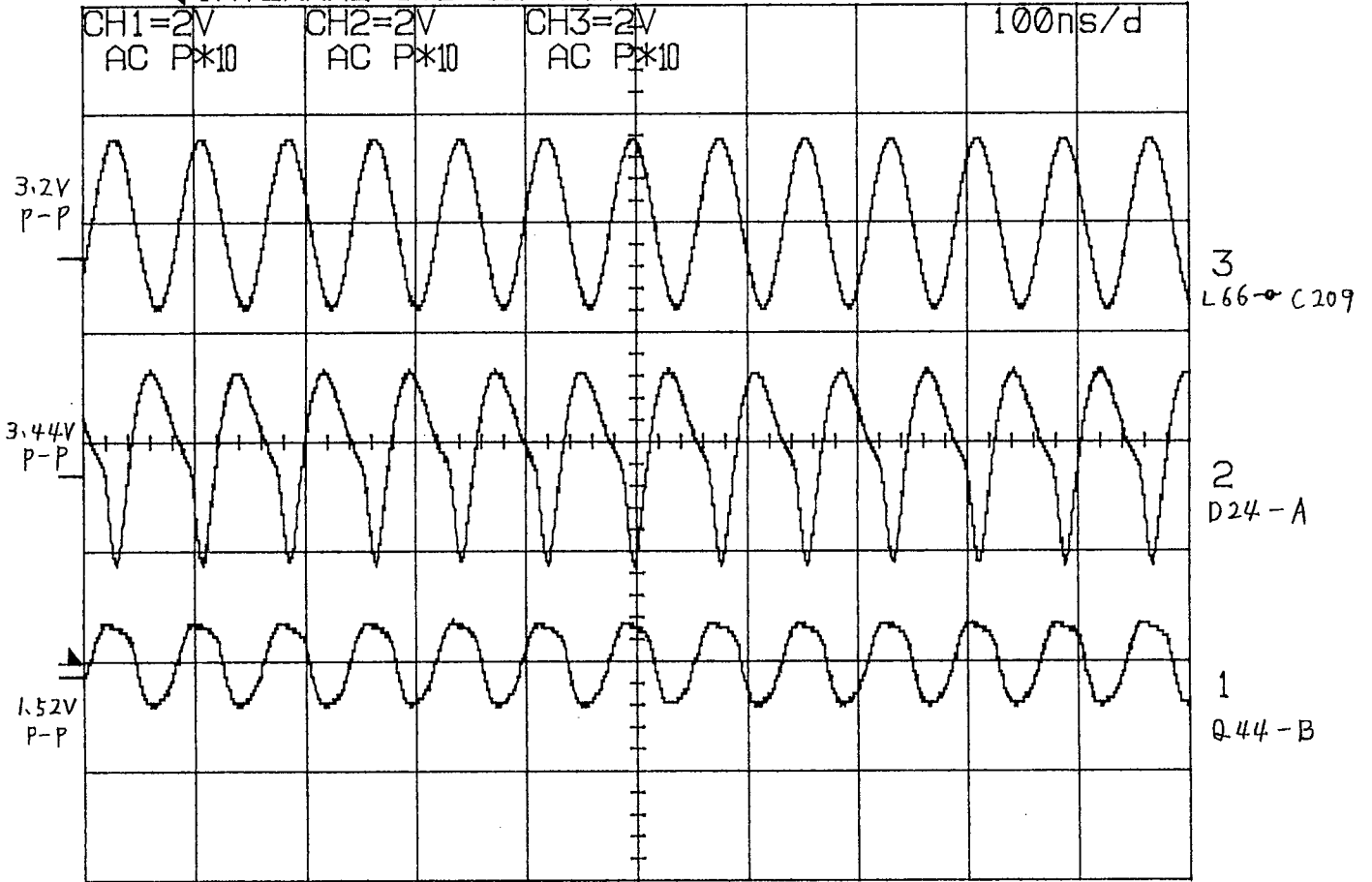

EXTERNAL STD 10.0MHz

09-AUG-1997 10:08

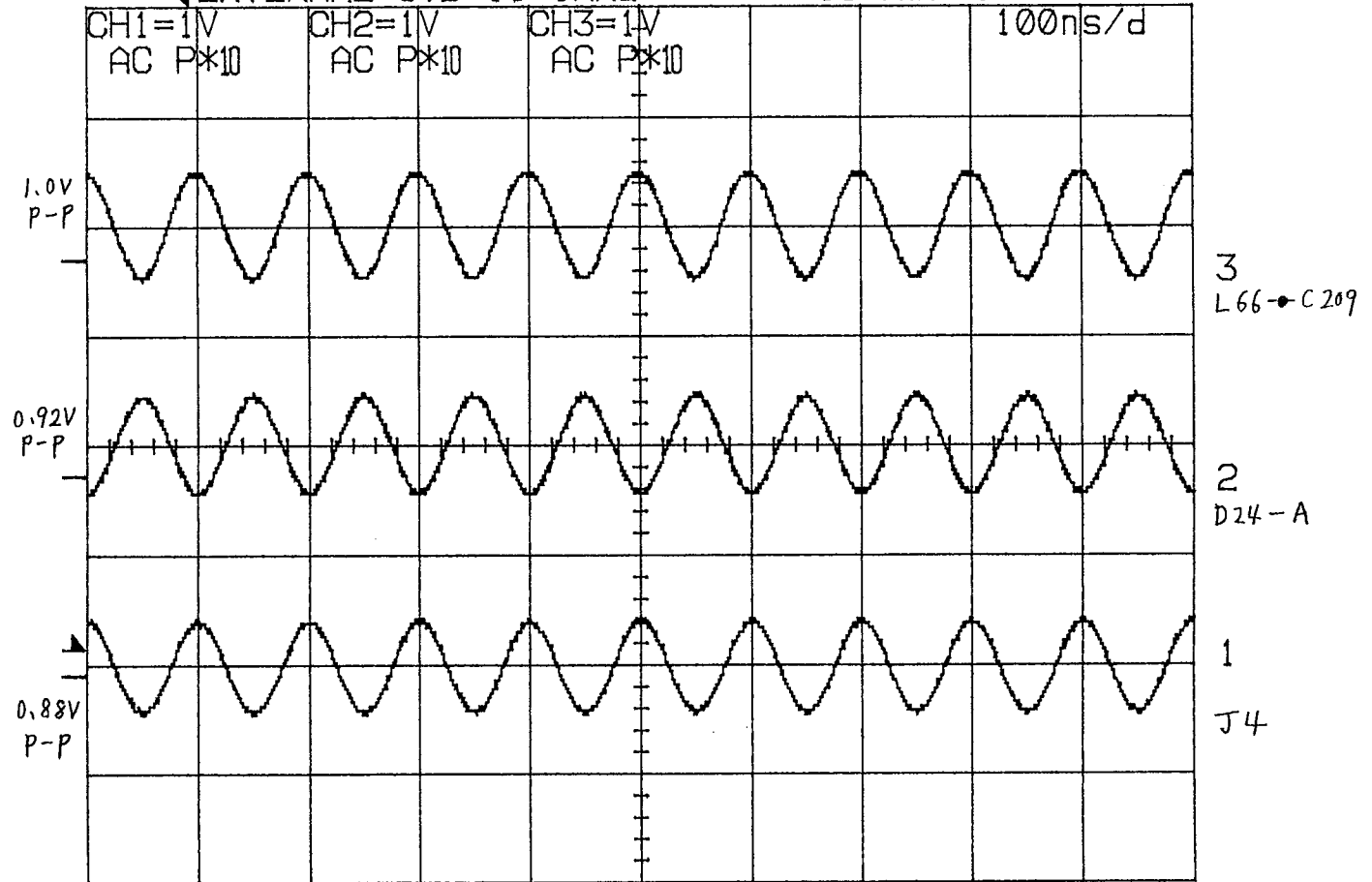

16:49:26 SEP 10, 1997

FRONT - A

BAND1 LPF AT 10 dB MKR 500 KHZ
REF .0 dBm 7.42 dB

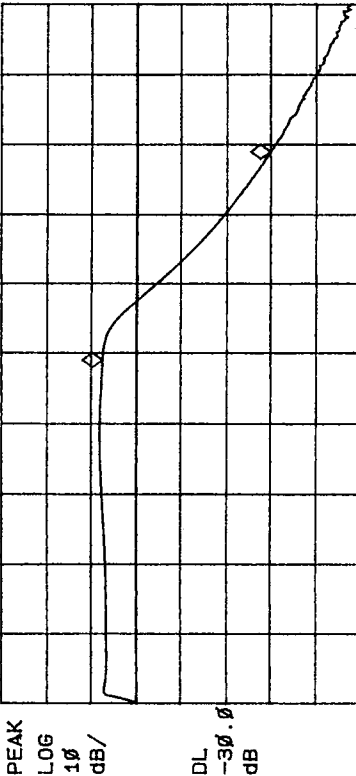

Marker	Trace Type	Freq	Time	Amplitude
1:	(A)	0.500 MHz		7.42dB
2:	(A)	0.800 MHz		-30.06dB
3:	Inactive			
4:	Inactive			

CENTER 510 KHZ RES BW 10 KHZ VBW 10 KHZ SPAN 1.000 MHZ SWP 30.0 msec

1. IN

① ANT 1
② LEVEL -30dBm

2. OUT
① R296 OPEN
② R296 → C139
③ DC

10KHZ FM

16:47:35 SEP 10, 1997

FRONT - C

BAND1 LPF AT 10 dB MKR 500 KHZ
REF .0 dBm -12.24 dB

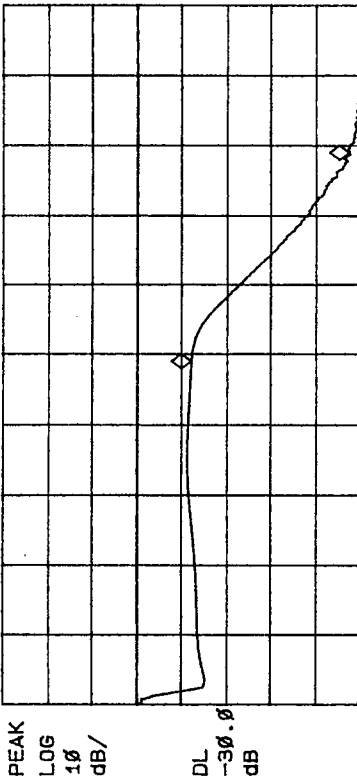

Marker	Trace Type	Freq	Time	Amplitude
1:	(A)	0.500 MHz		-12.24dB
2:	(A)	0.800 MHz		-47.77dB
3:	Inactive			
4:	Inactive			

CENTER 510 KHZ RES BW 10 KHZ VBW 10 KHZ SPAN 1.000 MHZ SWP 30.0 msec

1. IN

SAME AS A

2. OUT

SAME AS A
10KHZ FM
ATT = 20dB

16:45:25 SEP 10, 1997

FRONT - B

BAND1 LPF AT 10 dB MKR 500 KHZ
REF .0 dBm -1.33 dB

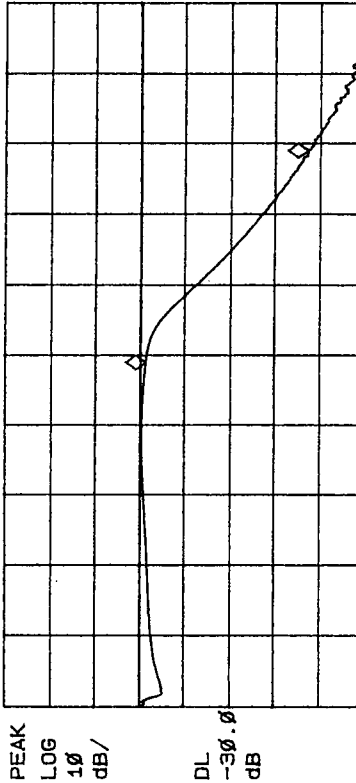

Marker	Trace Type	Freq	Time	Amplitude
1:	(A)	0.500 MHz		-1.33dB
2:	(A)	0.800 MHz		-37.49dB
3:	Inactive			
4:	Inactive			

CENTER 510 KHZ RES BW 10 KHZ VBW 10 KHZ SPAN 1.000 MHZ SWP 30.0 msec

1. IN

SAME AS A

2. OUT

SAME AS A
10KHZ FM
ATT = 10dB

17: 14: 26 SEP 10, 1997
BAND4 TUNE-BPF

FRONT2 - A
AT 10 dB
MKR 500 KHZ
6.12 dB

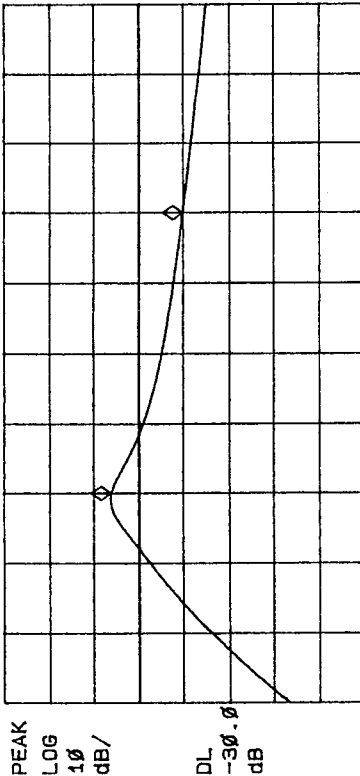

1. IN
 ① ANTI
 ② LEVEL
 -30dBm
 2. OUT
 ① R296 OPEN
 ② R296 → C139
 ③ DC
 500KHZ FM
 D/A = 34 (TUNE)

Marker	Trace Type	Freq / Time	Amplitude
1:	(A) Freq	0.500 MHz	6.12dB DL
2:	(A) Freq	0.900 MHz	-9.92dB DL
3:	Inactive		
4:	Inactive		

CENTER 700 KHZ
 RES BW 10 KHZ
 VBW 10 KHZ
 SPAN 1.000 MHz
 SWP 30.0 msec

17: 19: 31 SEP 10, 1997
BAND4 TUNE-BPF

FRONT2 - B
AT 10 dB
MKR 900 KHZ
7.21 dB

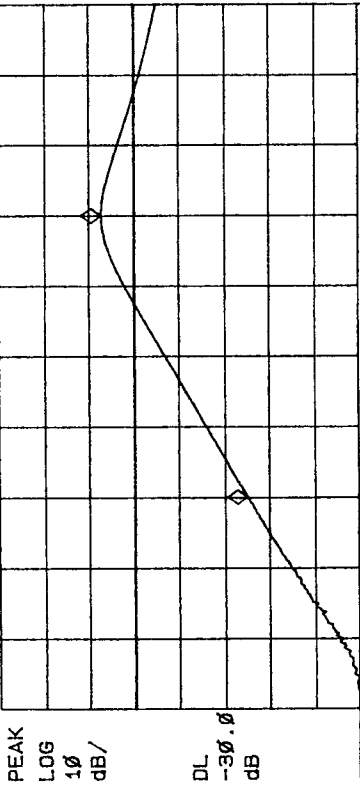

1. IN
 Same as A
 2. OUT
 Same as A
 899KHZ FM
 D/A = 210 (TUNE)

Marker	Trace Type	Freq / Time	Amplitude
1:	(A) Freq	0.900 MHz	-25.24dB DL
2:	(A) Freq	0.900 MHz	7.21dB DL
3:	Inactive		
4:	Inactive		

CENTER 700 KHZ
 RES BW 10 KHZ
 VBW 10 KHZ
 SPAN 1.000 MHz
 SWP 30.0 msec

17: 34: 49 SEP 10, 1997
BAND5 TUNE-FILTER

FRONT2 - C
AT 10 dB
MKR 900 KHZ
7.02 dB

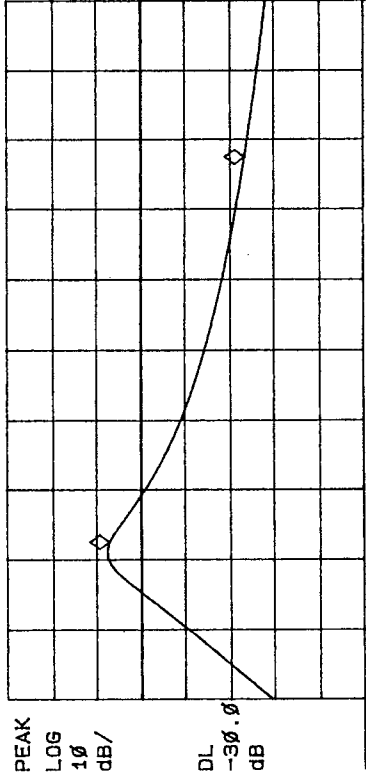

1. IN
 A & B
 2. OUT
 Same as A
 900KHZ FM
 D/A = 39 (TUNE)

Marker	Trace Type	Freq / Time	Amplitude
1:	(A) Freq	0.900 MHz	7.02dB DL
2:	(A) Freq	2.000 MHz	-23.54dB DL
3:	Inactive		
4:	Inactive		

CENTER 1.450 MHz
 RES BW 10 KHZ
 VBW 10 KHZ
 SPAN 2.000 MHz
 SWP 60.0 msec

17: 32: 45 SEP 10, 1997
BAND5 TUNE-FILTER

FRONT2 - D
AT 10 dB
MKR 1.995 MHz
11.42 dB

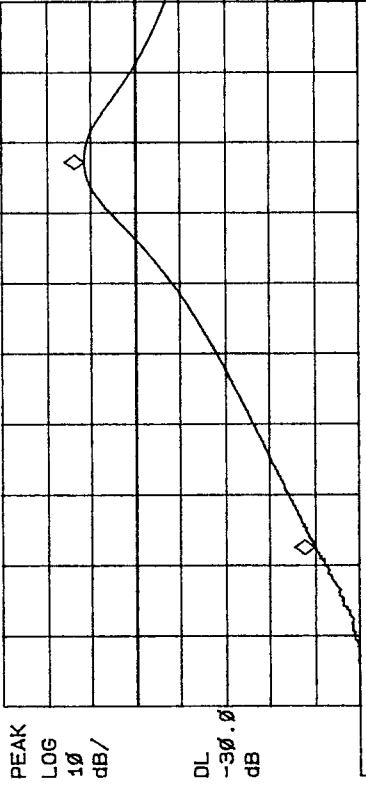

1. IN
 Same as A
 2. OUT
 Same as A
 1.999 MHz FM
 D/A = 230 (TUNE)

Marker	Trace Type	Freq / Time	Amplitude
1:	(A) Freq	0.900 MHz	-40.13dB DL
2:	(A) Freq	1.995 MHz	11.42dB DL
3:	Inactive		
4:	Inactive		

CENTER 1.450 MHz
 RES BW 10 KHZ
 VBW 10 KHZ
 SPAN 2.000 MHz
 SWP 60.0 msec

17:49:01 SEP 10, 1997

BAND6 TUNE-BPF FRONT3 - A MKR 2.000 MHz 7.37 dB

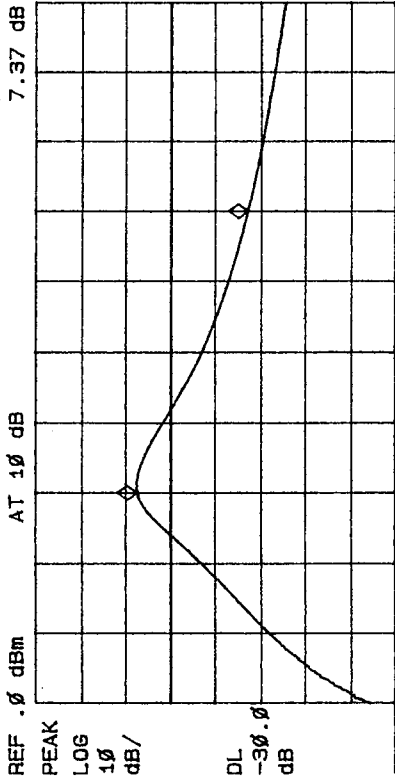

1. IN
 ① ANTI
 ② LEVEL -30dBm
 2. OUT
 ① R296 OPEN
 ② R296 ← C139
 ③ DC
 2.0 MHz FM
 D/A = 66 (TUNE)

Marker	Trace Type	Freq / Time	Amplitude
1:	(A) Freq	2.000 MHz	7.37dB DL
2:	(A) Freq	4.000 MHz	-17.46dB DL
3:	Inactive		
4:	Inactive		

CENTER 3.000 MHz SPAN 5.000 MHz
 RES BW 30 kHz VBW 30 kHz SWP 20.0 msec

17:47:36 SEP 10, 1997

BAND6 TUNE-BPF FRONT3 - B MKR 4.000 MHz 10.12 dB

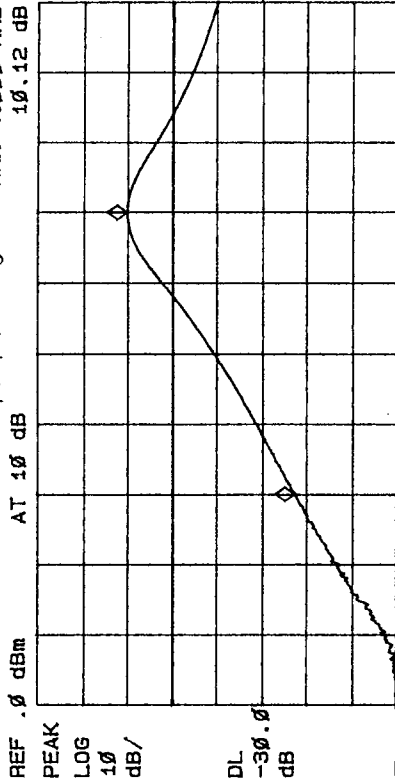

1. IN
 Same as A
 2. OUT
 Same as A

Marker	Trace Type	Freq / Time	Amplitude
1:	(A) Freq	2.000 MHz	-27.49dB DL
2:	(A) Freq	4.000 MHz	10.12dB DL
3:	Inactive		
4:	Inactive		

CENTER 3.000 MHz SPAN 5.000 MHz
 RES BW 30 kHz VBW 30 kHz SWP 20.0 msec

18:02:32 SEP 10, 1997

BAND7 TUNE-BPF FRONT3 - C MKR 4.000 MHz 7.94 dB

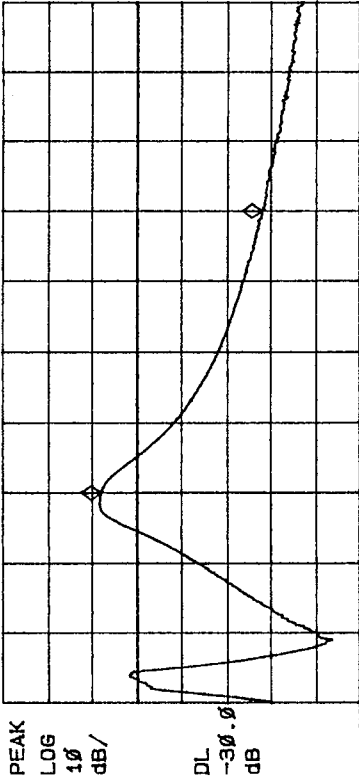

1. IN
 Same as A
 2. OUT
 Same as A

Marker	Trace Type	Freq / Time	Amplitude
1:	(A) Freq	4.000 MHz	7.94dB DL
2:	(A) Freq	10.000 MHz	-28.04dB DL
3:	Inactive		
4:	Inactive		

CENTER 7.000 MHz SPAN 15.000 MHz
 RES BW 100 kHz VBW 30 kHz SWP 20.0 msec

18:00:22 SEP 10, 1997

BAND7 TUNE-BPF FRONT3 - D MKR 10.000 MHz 8.59 dB

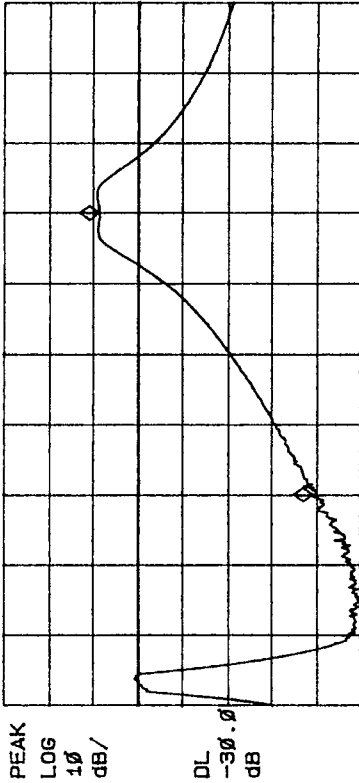

1. IN
 Same as A
 2. OUT
 Same as A

Marker	Trace Type	Freq / Time	Amplitude
1:	(A) Freq	4.000 MHz	-39.38dB DL
2:	(A) Freq	10.000 MHz	8.59dB DL
3:	Inactive		
4:	Inactive		

CENTER 7.000 MHz SPAN 15.000 MHz
 RES BW 100 kHz VBW 30 kHz SWP 20.0 msec

7.999 MHz FM
 D/A = 220 (TUNE)

18: 24: 11 SEP 10, 1997

FRONT4 - A

BAND8 TUNE-BPF MKR 10.000 MHz
REF .0 dBm AT 10 dB 7.15 dB

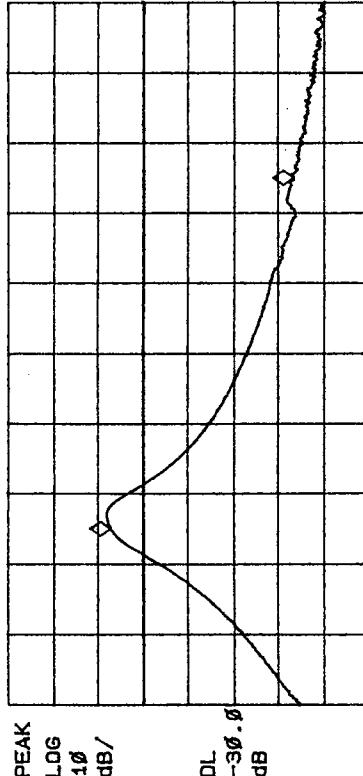

1. IN
 ① ANTI
 ② LEVEL
 -30dBm
 2. OUT
 ① R276 OPEN
 ② R276 → C139
 ③ DC

Marker	Trace Type	Freq / Time	Amplitude
1:	(A) Freq	10.00 MHz	7.15dBm
2:	(A) Freq	20.00 MHz	-33.50dBm
3:	Inactive		
4:	Inactive		

CENTER 15.00 MHz
 RES BW 100 kHz
 VBW 30 kHz
 SPAN 20.00 MHz
 SWP 20.00 msec

10.000 MHz FM
 D/A = 35 (TUNE)

18: 25: 53 SEP 10, 1997

FRONT4 - B

BAND8 TUNE-BPF MKR 20.000 MHz
REF .0 dBm AT 10 dB 7.85 dB

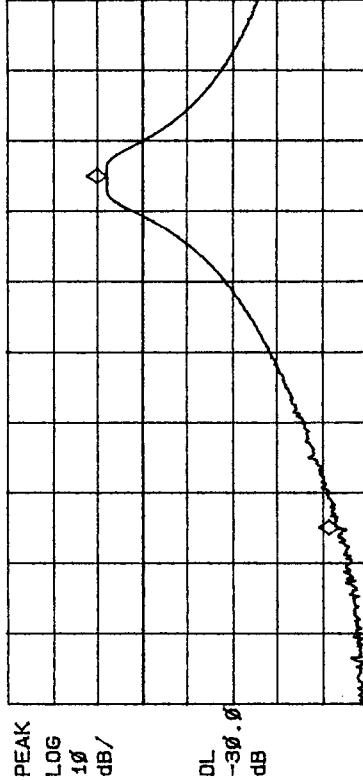

1. IN
 same as A
 2. OUT
 same as A

Marker	Trace Type	Freq / Time	Amplitude
1:	(A) Freq	10.00 MHz	-43.83dBm
2:	(A) Freq	20.00 MHz	7.85dBm
3:	Inactive		
4:	Inactive		

CENTER 15.00 MHz
 RES BW 100 kHz
 VBW 30 kHz
 SPAN 20.00 MHz
 SWP 20.00 msec

19.999 MHz FM
 D/A = 193 (TUNE)

18: 41: 08 SEP 10, 1997

FRONT4 - C

BAND9 TUNE-BPF MKR 20.000 MHz
REF .0 dBm AT 10 dB 6.11 dB

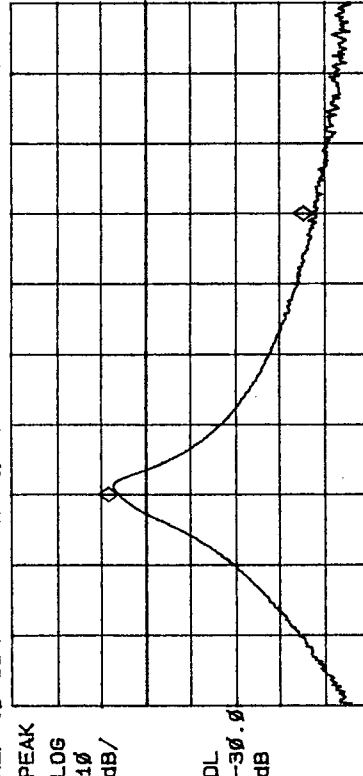

1. IN
 same as A
 2. OUT
 same as A

Marker	Trace Type	Freq / Time	Amplitude
1:	(A) Freq	20.00 MHz	6.11dBm
2:	(A) Freq	40.00 MHz	-37.73dBm
3:	Inactive		
4:	Inactive		

CENTER 30.00 MHz
 RES BW 300 kHz
 VBW 100 kHz
 SPAN 50.00 MHz
 SWP 20.00 msec

20.000 MHz FM
 D/A = 32 (TUNE)

18: 39: 25 SEP 10, 1997

FRONT4 - D

BAND9 TUNE-BPF MKR 40.000 MHz
REF .0 dBm AT 10 dB 7.35 dB

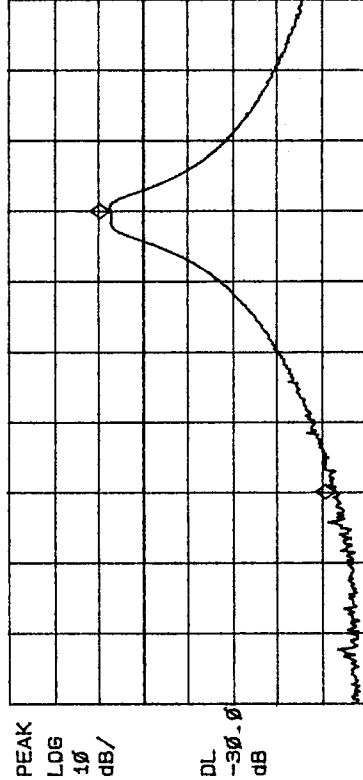

1. IN
 same as A
 2. OUT
 same as A

Marker	Trace Type	Freq / Time	Amplitude
1:	(A) Freq	20.00 MHz	-43.21dBm
2:	(A) Freq	40.00 MHz	7.35dBm
3:	Inactive		
4:	Inactive		

CENTER 30.00 MHz
 RES BW 300 kHz
 VBW 100 kHz
 SPAN 50.00 MHz
 SWP 20.00 msec

39.999 MHz FM
 D/A = 195 (TUNE)

11:33:11 SEP 11, 1997
 BAND10 TUNE-BPF
 REF .0 dBm AT 10 dB

FRONT 5 - A
 MKR 40.0 MHz
 16.47 dB

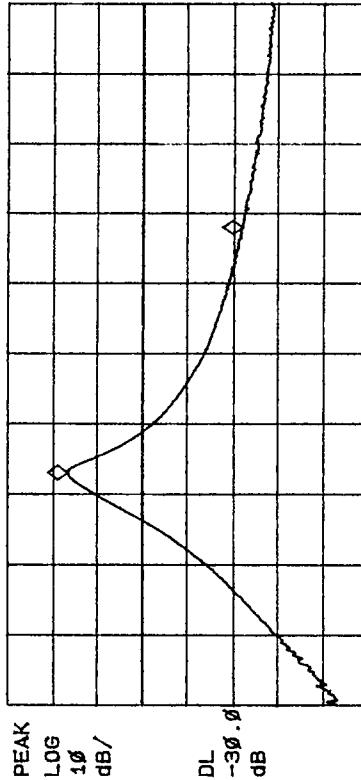

Marker	Trace Type	Freq / Time	Amplitude
1:	(A)	40.0 MHz	16.47dBOL
2:	(A)	75.0 MHz	-22.29dBOL
3:	Inactive		
4:	Inactive		

CENTER 57.0 MHz
 RES BW 1.0 MHz
 VBW 300 kHz
 SPAN 100.0 MHz
 SWP 20.0 msec

1. IN
 ① ANTI
 ② LEVEL
 -30dBm
 2. OUT
 ① R276 OPEN
 ② R296 → C139
 ③ DC
 40.000 MHz FM
 D/A = 53 (TUNE)

11:31:44 SEP 11, 1997
 BAND10 TUNE-BPF
 REF .0 dBm AT 10 dB

FRONT 5 - B
 MKR 75.0 MHz
 13.23 dB

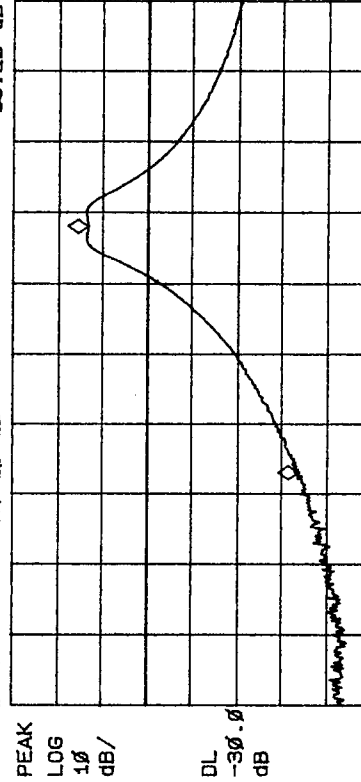

Marker	Trace Type	Freq / Time	Amplitude
1:	(A)	40.0 MHz	-33.85dBOL
2:	(A)	75.0 MHz	13.23dBOL
3:	Inactive		
4:	Inactive		

CENTER 57.0 MHz
 RES BW 1.0 MHz
 VBW 300 kHz
 SPAN 100.0 MHz
 SWP 20.0 msec

1. IN
 Same as A
 2. OUT
 Same as A
 74.999 MHz FM
 D/A = 205 (TUNE)

11:25:03 SEP 11, 1997
 BAND11 TUNE-BPF
 REF .0 dBm AT 10 dB

FRONT 5 - C
 MKR 75.0 MHz
 14.93 dB

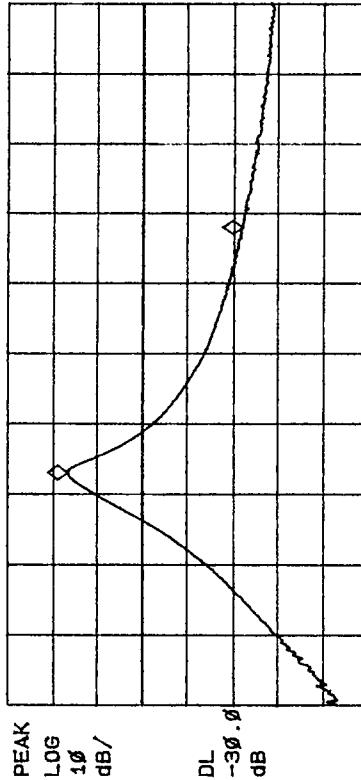

Marker	Trace Type	Freq / Time	Amplitude
1:	(A)	75.0 MHz	14.93dBOL
2:	(A)	150.0 MHz	-26.41dBOL
3:	Inactive		
4:	Inactive		

CENTER 112.0 MHz
 RES BW 1.0 MHz
 VBW 300 kHz
 SPAN 200.0 MHz
 SWP 20.0 msec

1. IN
 Same as A
 2. OUT
 Same as A
 75.000 MHz FM
 D/A = 52 (TUNE)

11:23:10 SEP 11, 1997
 BAND11 TUNE-BPF
 REF .0 dBm AT 10 dB

FRONT 5 - D
 MKR 150.0 MHz
 14.77 dB

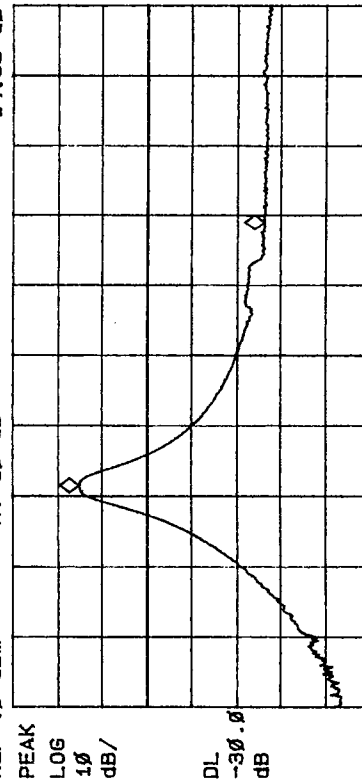

Marker	Trace Type	Freq / Time	Amplitude
1:	(A)	75.0 MHz	-37.47dBOL
2:	(A)	150.0 MHz	14.77dBOL
3:	Inactive		
4:	Inactive		

CENTER 112.0 MHz
 RES BW 1.0 MHz
 VBW 300 kHz
 SPAN 200.0 MHz
 SWP 20.0 msec

1. IN
 Same as A
 2. OUT
 Same as A
 149.999 MHz FM
 D/A = 240 (TUNE)

11: 44: 54 SEP 11, 1997
 BAND12 TUNE-BPF
 REF .0 dBm AT 10 dB

FRONT6 - A
 MKR 150.0 MHz
 20.02 dB

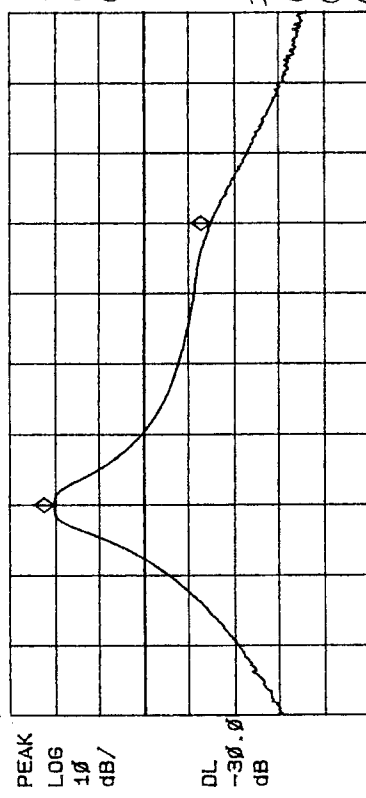

Marker	Trace Type	Freq / Time	Amplitude
1:	(A) Freq	150.0 MHz	20.02dB
2:	(A) Freq	230.0 MHz	-15.05dB
3:	Inactive		
4:	Inactive		

CENTER 190.0 MHz
 RES BW 1.0 MHz
 VBW 300 kHz
 SPAN 200.0 MHz
 SWP 20.0 msec

1. IN
 ANTI
 LEVEL
 -30dBm
 2. OUT
 R 296 OPEN
 R 296 C139
 DC

150.000 MHz FM
 D/A = 39 (TUNE)

11: 42: 41 SEP 11, 1997
 BAND12 TUNE-BPF
 REF .0 dBm AT 10 dB

FRONT6 - B
 MKR 230.0 MHz
 12.87 dB

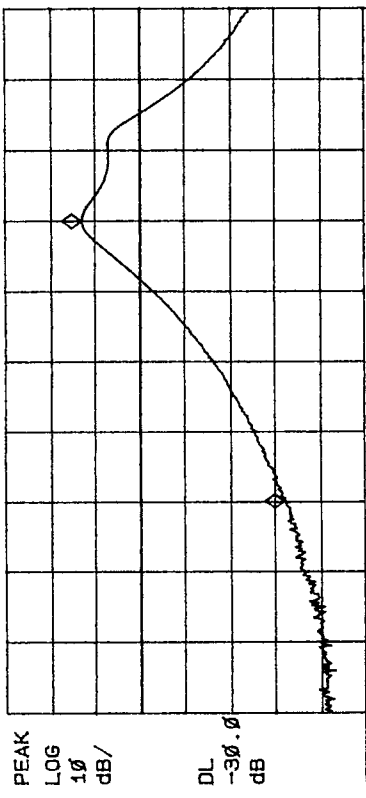

Marker	Trace Type	Freq / Time	Amplitude
1:	(A) Freq	150.0 MHz	-32.28dB
2:	(A) Freq	230.0 MHz	12.87dB
3:	Inactive		
4:	Inactive		

CENTER 190.0 MHz
 RES BW 1.0 MHz
 VBW 300 kHz
 SPAN 200.0 MHz
 SWP 20.0 msec

1. IN
 Same as A
 2. OUT
 Same as A

230.000 MHz FM
 D/A = 230 (TUNE)

11: 56: 49 SEP 11, 1997
 BAND13 TUNE-BPF
 REF .0 dBm AT 10 dB

FRONT6 - C
 MKR 230.0 MHz
 13.52 dB

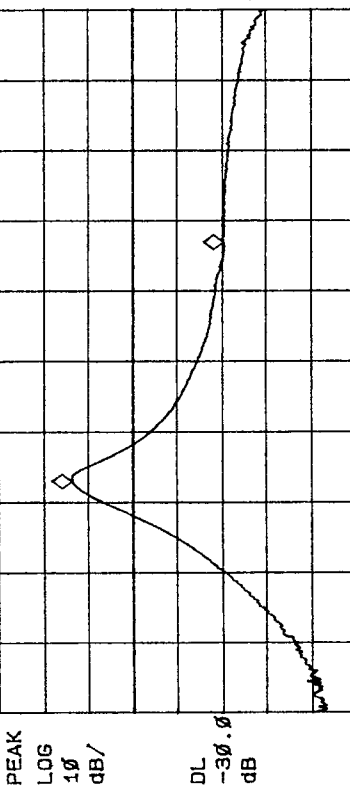

Marker	Trace Type	Freq / Time	Amplitude
1:	(A) Freq	230.0 MHz	13.52dB
2:	(A) Freq	400.0 MHz	-20.58dB
3:	Inactive		
4:	Inactive		

CENTER 315.0 MHz
 RES BW 1.0 MHz
 VBW 300 kHz
 SPAN 500.0 MHz
 SWP 20.0 msec

1. IN
 Same as A
 2. OUT
 Same as A

230.000 MHz FM
 D/A = 14 (TUNE)

11: 56: 43 SEP 11, 1997
 BAND13 TUNE-BPF
 REF .0 dBm AT 10 dB

FRONT6 - D
 MKR 400.0 MHz
 11.24 dB

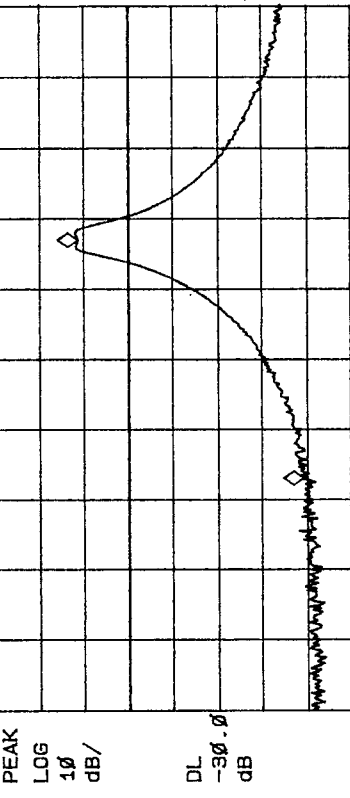

Marker	Trace Type	Freq / Time	Amplitude
1:	(A) Freq	230.0 MHz	-39.40dB
2:	(A) Freq	400.0 MHz	11.24dB
3:	Inactive		
4:	Inactive		

CENTER 315.0 MHz
 RES BW 1.0 MHz
 VBW 300 kHz
 SPAN 500.0 MHz
 SWP 20.0 msec

1. IN
 Same as A
 2. OUT
 Same as A

399.999 MHz FM
 D/A = 139 (TUNE)

13:05:25 SEP 11, 1997
 BAND14 TUNE-BPF
 REF .0 dBm AT 10 dB

FRONT7 - A MKR 400 MHz
 17.02 dB

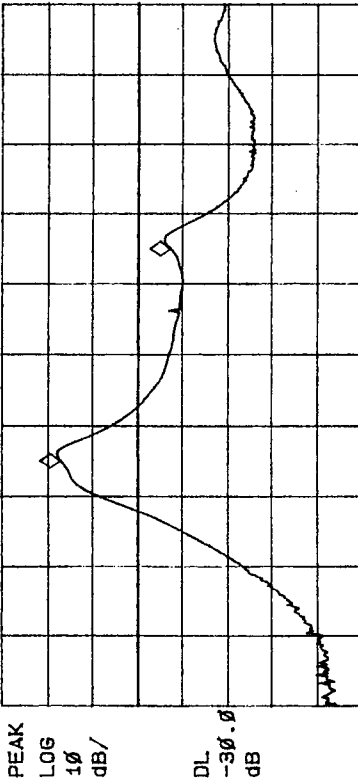

Marker	Trace Type	Freq	Time	Amplitude
1:	(A)	400 MHz		17.02dB
2:	(A)	700 MHz		-7.25dB
3:	Inactive			
4:	Inactive			

CENTER 550 MHz
 #RES BW 1.0 MHz VBW 300 kHz SPAN 1.000 GHz SWP 20.0 msec

1. IN
 ① ANTI
 ② LEVEL -30dBm
 2. OUT
 ① R297 OPEN
 ② R297 → C288
 ③ DC
 400.000 MHz FM
 D/A = 22 (TUNE)

Same as A

2. OUT

Same as A

699.999 MHz FM
 D/A = 170 (TUNE)

13:03:58 SEP 11, 1997
 BAND14 TUNE-BPF
 REF .0 dBm AT 10 dB

FRONT7 - B

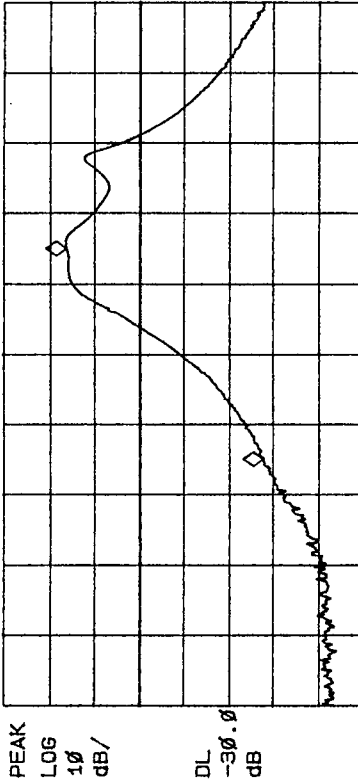

Marker	Trace Type	Freq	Time	Amplitude
1:	(A)	400 MHz		-27.84dB
2:	(A)	700 MHz		16.17dB
3:	Inactive			
4:	Inactive			

CENTER 550 MHz
 #RES BW 1.0 MHz VBW 300 kHz SPAN 1.000 GHz SWP 20.0 msec

1. IN

Same as A

2. OUT

Same as A

699.999 MHz FM
 D/A = 170 (TUNE)

13:13:36 SEP 11, 1997
 BAND15 TUNE-BPF
 REF .0 dBm AT 10 dB

FRONT7 - C MKR 700 MHz
 13.41 dB

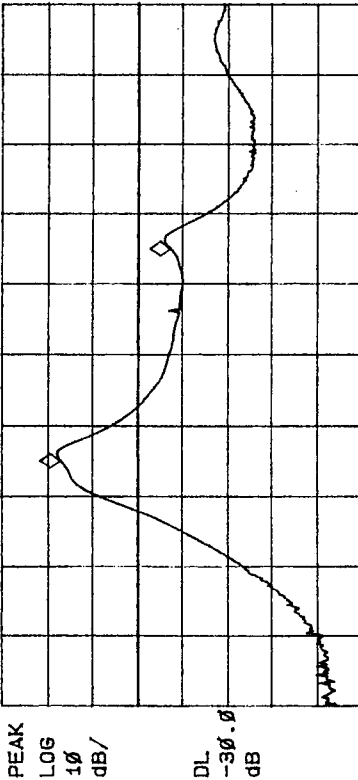

Marker	Trace Type	Freq	Time	Amplitude
1:	(A)	700 MHz		13.41dB
2:	(A)	1000 MHz		-17.06dB
3:	Inactive			
4:	Inactive			

CENTER 850 MHz
 #RES BW 1.0 MHz VBW 300 kHz SPAN 1.000 GHz SWP 20.0 msec

1. IN
 ① ANTI
 ② LEVEL -30dBm
 2. OUT
 ① R297 OPEN
 ② R297 → C288
 ③ DC
 700.000 MHz FM
 D/A = 71 (TUNE)

Same as A

2. OUT

Same as A

999.999 MHz FM
 D/A = 165 (TUNE)

13:11:09 SEP 11, 1997
 BAND15 TUNE-BPF
 REF .0 dBm AT 10 dB

FRONT7 - D MKR 1.000 GHz
 12.23 dB

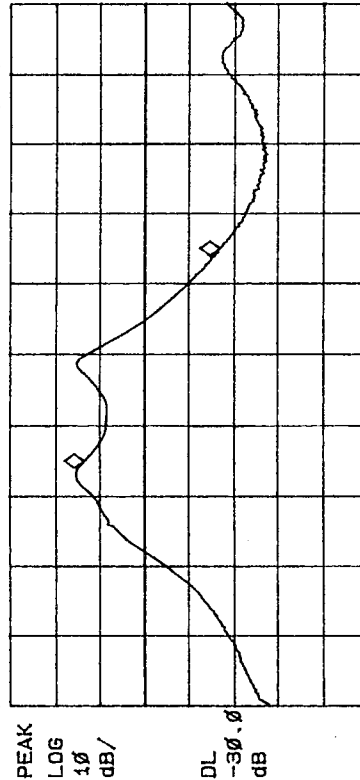

Marker	Trace Type	Freq	Time	Amplitude
1:	(A)	700 MHz		-8.20dB
2:	(A)	1000 MHz		12.23dB
3:	Inactive			
4:	Inactive			

CENTER 850 MHz
 #RES BW 1.0 MHz VBW 300 kHz SPAN 1.000 GHz SWP 20.0 msec

1. IN

Same as A

2. OUT

Same as A

999.999 MHz FM
 D/A = 165 (TUNE)

13:11:09 SEP 11, 1997
 BAND15 TUNE-BPF
 REF .0 dBm AT 10 dB

FRONT7 - D

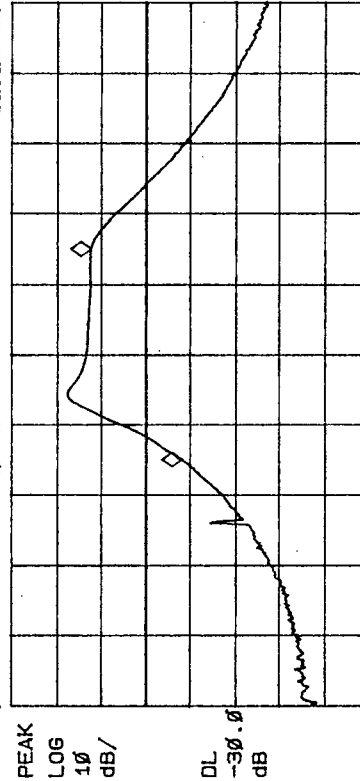

Marker	Trace Type	Freq	Time	Amplitude
1:	(A)	700 MHz		-8.20dB
2:	(A)	1000 MHz		12.23dB
3:	Inactive			
4:	Inactive			

CENTER 850 MHz
 #RES BW 1.0 MHz VBW 300 kHz SPAN 1.000 GHz SWP 20.0 msec

1. IN

Same as A

2. OUT

Same as A

999.999 MHz FM
 D/A = 165 (TUNE)

13: 44: 37 SEP 11, 1997
BAND16 BPE

FRONT 8 - A MKR 1.600 GHz
AT 10 dB

REF -0.0 dBm

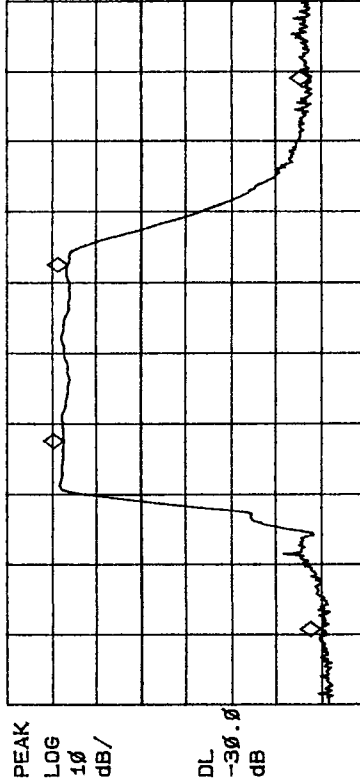

1. IN
 ① ANTI
 ② LEVEL -30dBm
 2. OUT
 ① R297 OPEN
 ② R297 → C288
 ③ DC

Marker	Trace Type	Freq	Time	Amplitude
1:	(A) Freq	358 MHz		-39.99dBm
2:	(A) Freq	1000 MHz		17.20dBm
3:	(A) Freq	1600 MHz		16.20dBm
4:	(A) Freq	2236 MHz		-37.79dBm

START 1000 MHz #RES BW 1.0 MHz VBW 300 kHz STOP 2.500 GHz SWP 48.0 msec

14: 16: 31 SEP 11, 1997
FIRST IF FILTER

FRONT 8 - C MKR 622.40 MHz
AT 10 dB

REF -10.0 dBm

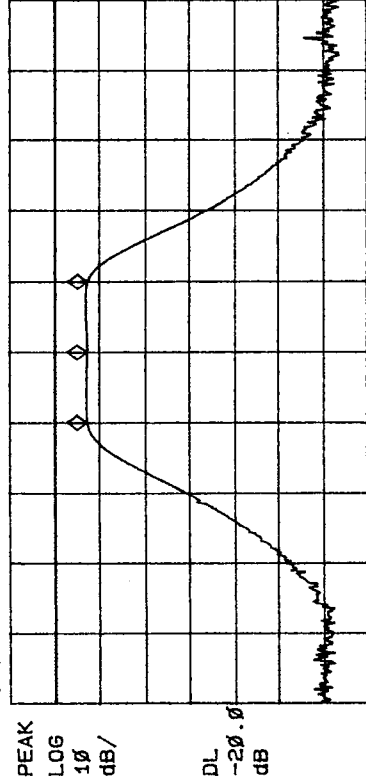

Marker	Trace Type	Freq	Time	Amplitude
1:	(A) Freq	617.40 MHz		-7.30dBm
2:	(A) Freq	622.40 MHz		-7.32dBm
3:	(A) Freq	627.40 MHz		-7.42dBm
4:	Inactive			

CENTER 622.40 MHz #RES BW 100 kHz VBW 30 kHz SPAN 50.00 MHz SWP 50.0 msec

13: 52: 16 SEP 11, 1997
BAND17 BPF

FRONT 8 - B MKR 2.606 GHz
AT 10 dB

REF -0.0 dBm

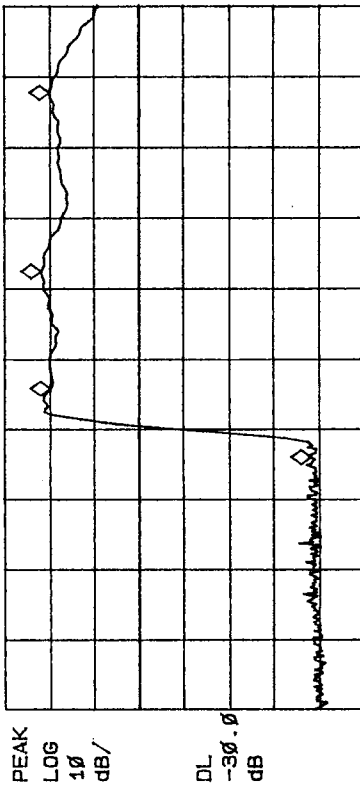

1. IN
 same as A
 2. OUT
 same as A

Marker	Trace Type	Freq	Time	Amplitude
1:	(A) Freq	1364 MHz		-38.43dBm
2:	(A) Freq	1598 MHz		19.68dBm
3:	(A) Freq	2000 MHz		21.75dBm
4:	(A) Freq	2606 MHz		19.81dBm

START 500 MHz #RES BW 1.0 MHz VBW 300 kHz STOP 2.900 GHz SWP 48.0 msec

1600.000 MHz FM

14:39:51 SEP 11, 1997
 BAND11 TUNE-BPF
 REF .0 dBm AT 10 dB

FRONT9 - A MKR 75.0 MHz
 -2.45 dB

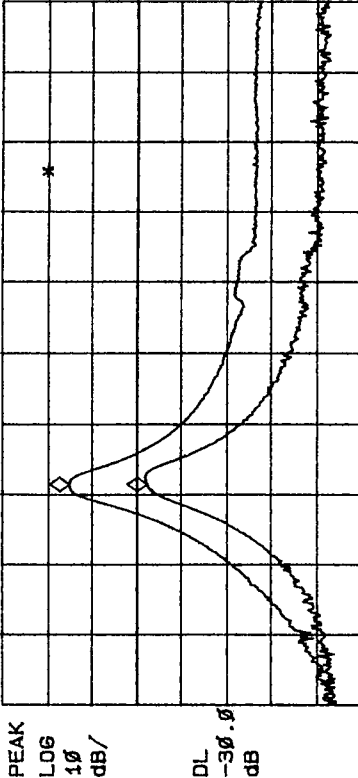

Marker	Trace Type	Freq	Time	Amplitude	ATT
1:	(A)	75.0 MHz		14.94 dB	0 dB
2:	(C)	75.0 MHz		-2.45 dB	10 dB
3:	Inactive				
4:	Inactive				

CENTER 112.0 MHz
 RES BW 1.0 MHz VBW 300 kHz SPAN 200.0 MHz
 SMP 20.0 msec

1. IN
 ① ANTI
 ② LEVEL
 -30 dBm

2. OUT
 ① R296 OPEN
 ② R296 → C139
 ③ DC
 75.000 MHz FM
 D/A = 52 (TUNE)

14:42:16 SEP 11, 1997
 BAND11 TUNE-BPF
 REF .0 dBm AT 10 dB

FRONT9 - B MKR 75.0 MHz
 -13.07 dB

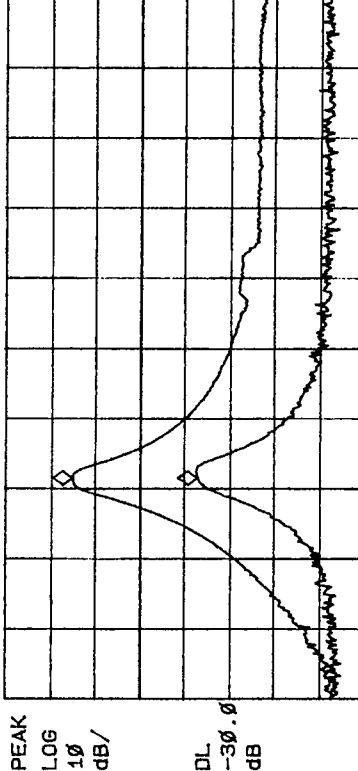

Marker	Trace Type	Freq	Time	Amplitude	ATT
1:	(A)	75.0 MHz		14.94 dB	0 dB
2:	(C)	75.0 MHz		-13.07 dB	20 dB
3:	Inactive				
4:	Inactive				

CENTER 112.0 MHz
 RES BW 1.0 MHz VBW 300 kHz SPAN 200.0 MHz
 SMP 20.0 msec

1. IN
 Same as A
 2. OUT
 Same as A
 75.000 MHz FM
 D/A = 52 (TUNE)

15:04:05 SEP 11, 1997
 BAND14 TUNE-BPF
 REF .0 dBm AT 10 dB

FRONT9 - C MKR 400 MHz
 7.46 dB

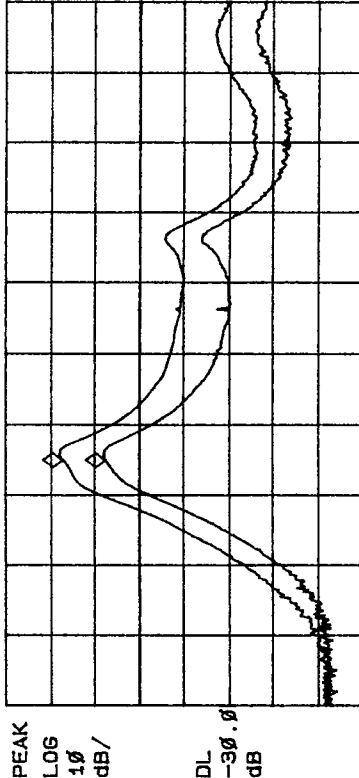

Marker	Trace Type	Freq	Time	Amplitude	ATT
1:	(A)	400 MHz		17.05 dB	0 dB
2:	(C)	400 MHz		7.46 dB	10 dB
3:	Inactive				
4:	Inactive				

CENTER 550 MHz
 RES BW 1.0 MHz VBW 300 kHz SPAN 1.000 GHz
 SMP 20.0 msec

1. IN
 Same as A
 2. OUT
 ① R297 OPEN
 ② R297 → C288
 ③ DC
 400.000 MHz FM
 D/A = 22 (TUNE)

16: 33: 37 SEP 11, 1997
10.7MHz MCF BW=3KHz
REF -20.0 dBm AT 10 dB

IF1 - A MKR 10.70000 MHz
22.56 dB

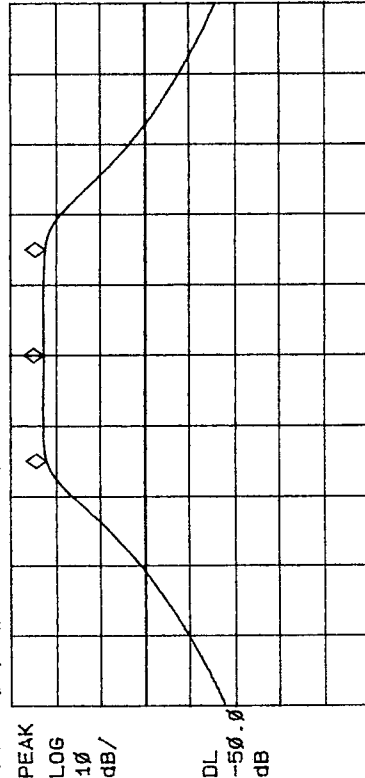

1. IN
 ① J7
 ② LEVEL -50dBm
 ③ DC 2
 2. OUT
 ① IF OUT REAR PANEL

Marker	Trace Type	Freq / Time	Amplitude
1:	(A) Freq	10.69850 MHz	21.95dB DL
2:	(A) Freq	10.70000 MHz	22.56dB DL
3:	(A) Freq	10.70150 MHz	22.19dB DL
4:	Inactive		

CENTER 10.70000 MHz SPAN 10.00 kHz
RES BW 100 Hz VBW 100 Hz SWP 3.00 sec

129.900MHz FM
AGC = 0FH

16: 44: 54 SEP 11, 1997
10.7MHz MCF BW=6KHz
REF -20.0 dBm AT 10 dB

IF1 - B MKR 10.70000 MHz
20.89 dB

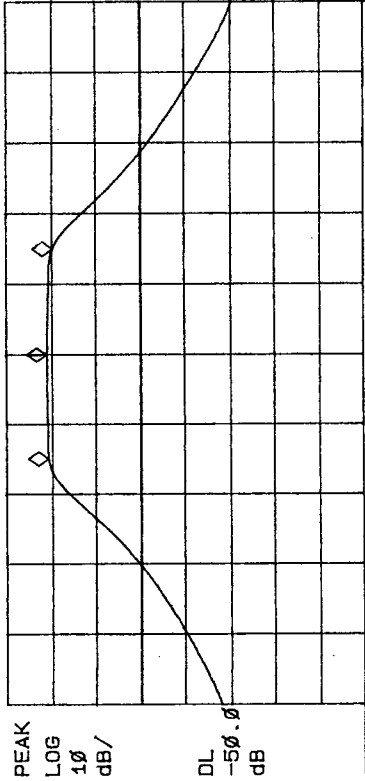

1. IN
 same as A
 2. OUT
 same as A

Marker	Trace Type	Freq / Time	Amplitude
1:	(A) Freq	10.69700 MHz	20.55dB DL
2:	(A) Freq	10.70000 MHz	20.89dB DL
3:	(A) Freq	10.70300 MHz	19.54dB DL
4:	Inactive		

CENTER 10.70000 MHz SPAN 20.00 kHz
RES BW 300 Hz VBW 300 Hz SWP 1.00 sec

129.900MHz FM
AGC = 0FH

15: 54: 36 SEP 11, 1997
10.7MHz MCF BW=15KHz
REF -20.0 dBm AT 10 dB

IF1 - C MKR 10.70000 MHz
19.91 dB

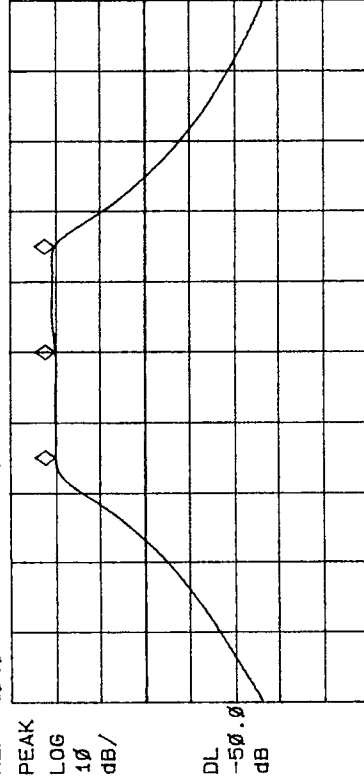

1. IN
 same as A
 2. OUT
 same as A

Marker	Trace Type	Freq / Time	Amplitude
1:	(A) Freq	10.69250 MHz	19.91dB DL
2:	(A) Freq	10.70000 MHz	19.91dB DL
3:	(A) Freq	10.70750 MHz	20.05dB DL
4:	Inactive		

CENTER 10.70000 MHz SPAN 50.00 kHz
RES BW 1.0 kHz VBW 1 kHz SWP 300 msec

129.900MHz FM
AGC = 0FH

16: 01: 24 SEP 11, 1997
10.7MHz MCF BW=30KHz
REF -20.0 dBm AT 10 dB

IF1 - D MKR 10.70000 MHz
16.74 dB

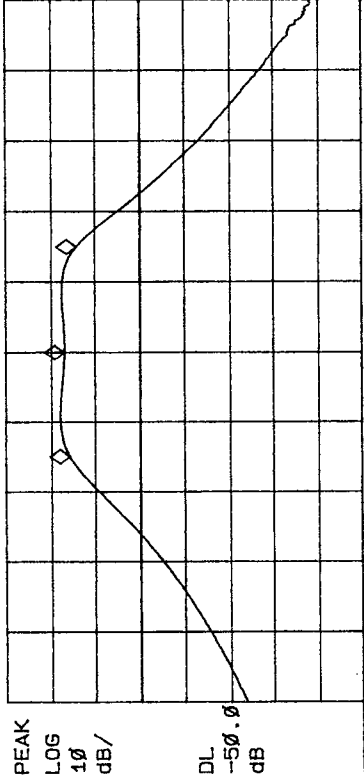

1. IN
 same as A
 2. OUT
 same as A

Marker	Trace Type	Freq / Time	Amplitude
1:	(A) Freq	10.68500 MHz	15.62dB DL
2:	(A) Freq	10.70000 MHz	16.74dB DL
3:	(A) Freq	10.71500 MHz	14.07dB DL
4:	Inactive		

CENTER 10.70000 MHz SPAN 100.0 kHz
RES BW 1.0 kHz VBW 1 kHz SWP 300 msec

129.900MHz FM
AGC = 0FH

16: 58: 48 SEP 11, 1997

10.7MHz MCF BW=110KHz IFR2 - A MKR 10.7000 MHz
REF -20.0 dBm AT 10 dB

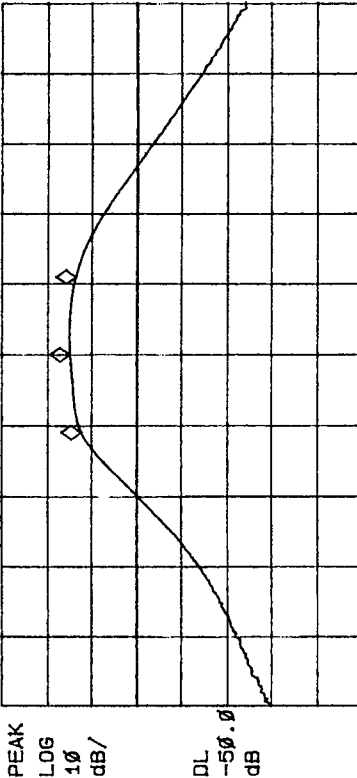

Marker	Trace Type	Freq / Time	Amplitude
1:	(A) Freq	10.6450 MHz	12.27dBdL
2:	(A) Freq	10.7000 MHz	14.80dBdL
3:	(A) Freq	10.7550 MHz	13.46dBdL
4:	Inactive		

CENTER 10.7000 MHz SPAN 500.0 KHz
RES BW 10 KHz VBW 10 KHz SWP 30.0 msec

17: 02: 33 SEP 11, 1997

10.7MHz MCF BW=220KHz IFR2 - B MKR 10.7000 MHz
REF -20.0 dBm AT 10 dB

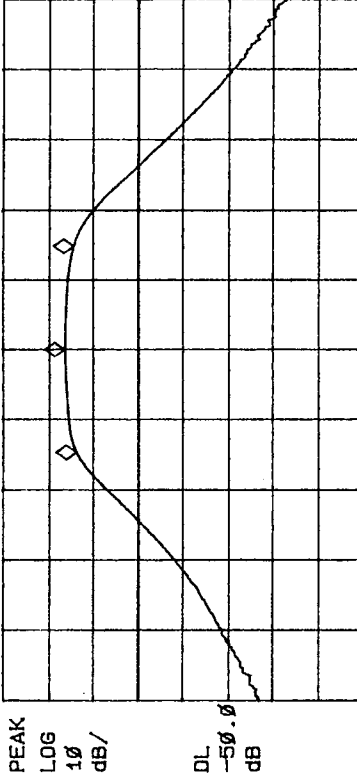

Marker	Trace Type	Freq / Time	Amplitude
1:	(A) Freq	10.5894 MHz	13.72dBdL
2:	(A) Freq	10.7000 MHz	16.25dBdL
3:	(A) Freq	10.8106 MHz	14.28dBdL
4:	Inactive		

CENTER 10.7000 MHz SPAN 750.0 KHz
RES BW 10 KHz VBW 10 KHz SWP 30.0 msec

18: 01: 50 SEP 13, 1997

10.7MHz EXT IFR2 - C MKR 10.7000 MHz
REF -20.0 dBm AT 10 dB

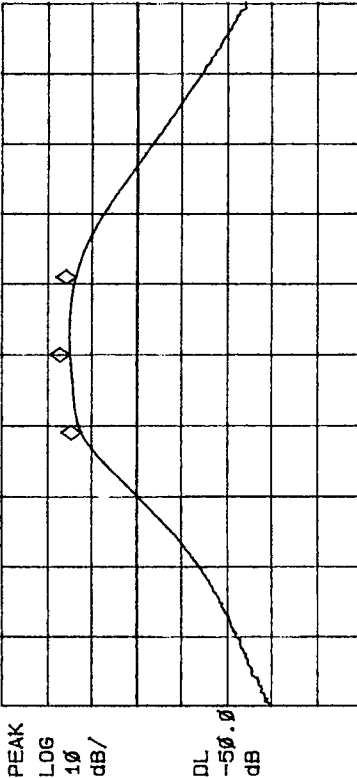

Marker	Trace Type	Freq / Time	Amplitude
1:	(A) Freq	5.70 MHz	6.90dBdL
2:	(A) Freq	10.70 MHz	8.14dBdL
3:	(A) Freq	15.70 MHz	6.71dBdL
4:	Inactive		

CENTER 10.7000 MHz SPAN 200.0 KHz
RES BW 100 KHz VBW 30 KHz SWP 20.0 msec

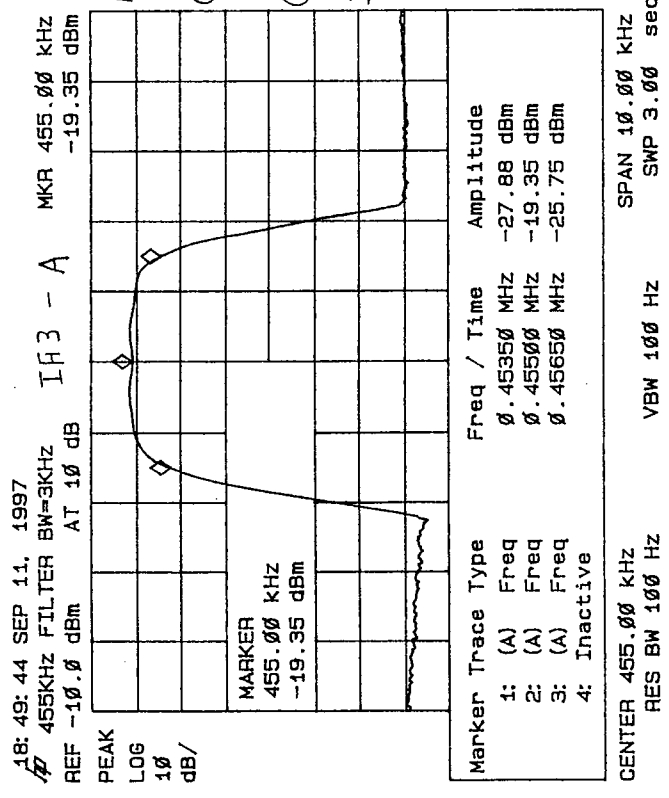

1. IN
 ① TPG
 ② LEVEL
 0 dBm
 ③ DC
 2. OUT
 ① VRI-3
 ② DC
 129.700MHz FM
 AGC=0FH

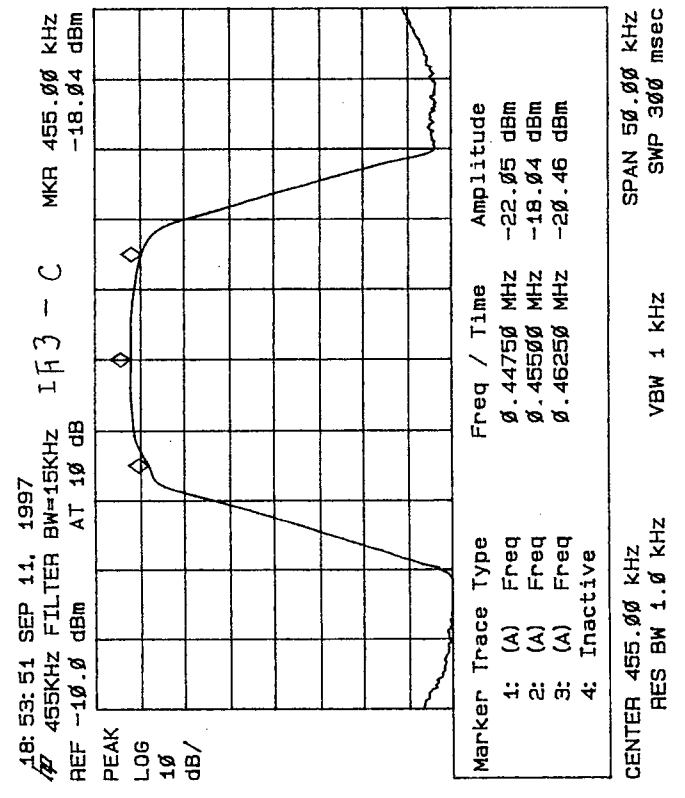

1. IN
 same as A
 2. OUT
 same as A
 129.700MHz FM
 AGC=0FH

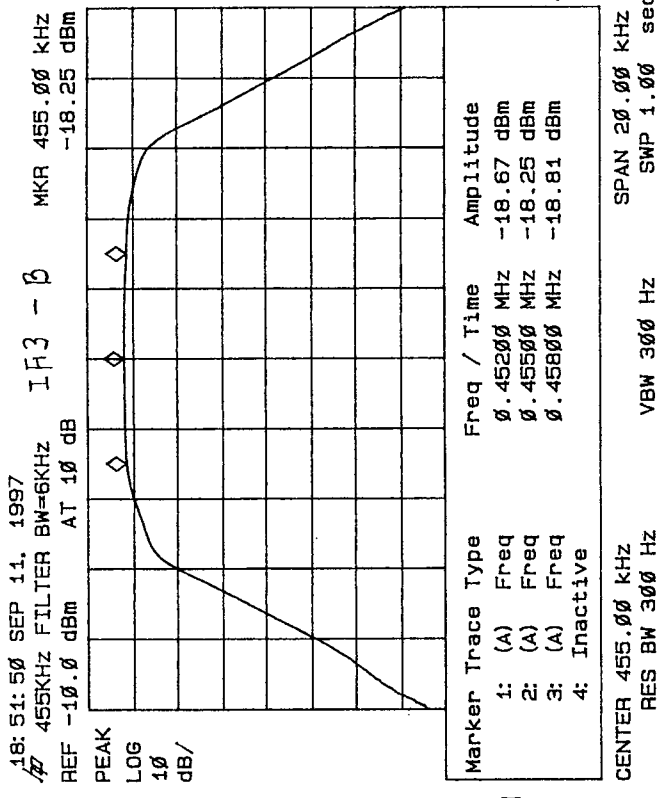

1. IN
 same as A
 2. OUT
 same as A
 129.700MHz FM
 AGC=0FH

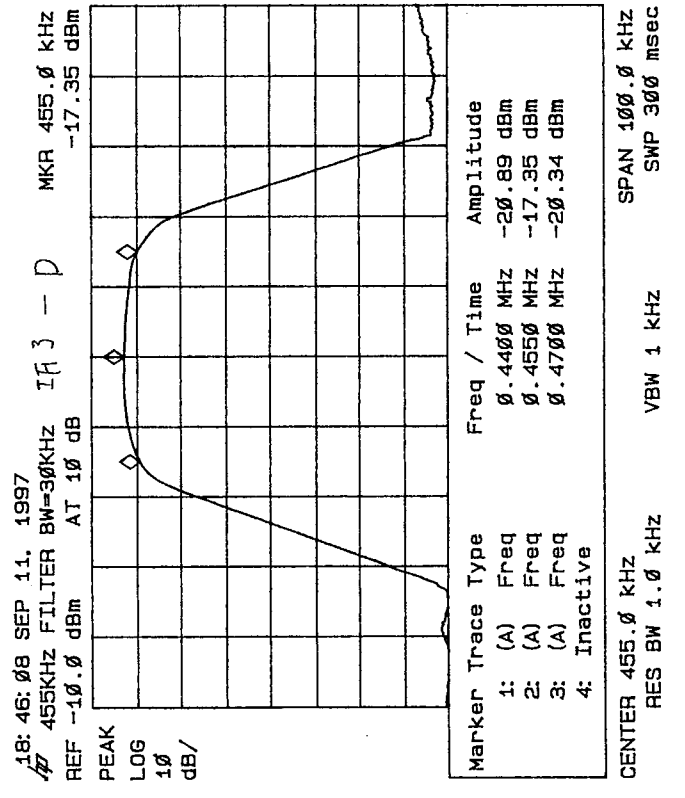

1. IN
 same as A
 2. OUT
 same as A
 129.700MHz FM
 AGC=0FH

18: 57: 35 SEP 11, 1997

455KHz FILTER BW=110KHz I R 4 - A
REF -10.0 dBm AT 10 dB

MKR 455.0 KHz
-17.47 dBm

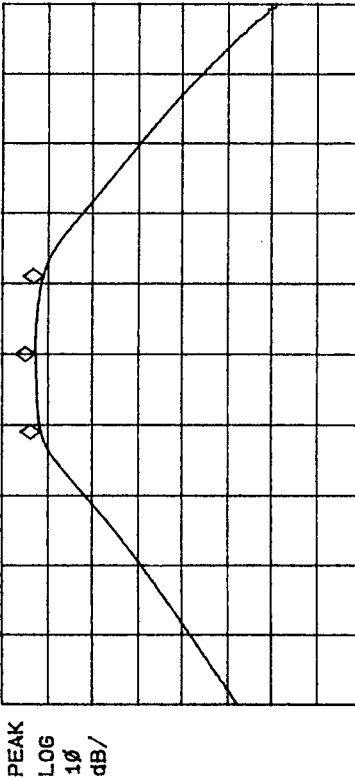

1. IN
 ① TPG
 ② LEVEL 0dBm
 ③ PC
 2. OUT
 ① VRI-3
 ② PC

Marker	Trace Type	Freq / Time	Amplitude
1:	(A) Freq	0.4000 MHz	-18.65 dBm
2:	(A) Freq	0.4550 MHz	-17.47 dBm
3:	(A) Freq	0.5100 MHz	-19.21 dBm
4:	Inactive		

CENTER 455.0 KHz
 RES BW 10 KHz
 VBM 10 KHz
 SPAN 500.0 KHz
 SWP 30.0 msec

129.900 MHz FM
 AGC = 0 FA

19: 00: 12 SEP 11, 1997

455KHz FILTER BW=220KHz I R 4 - B
REF -10.0 dBm AT 10 dB

MKR 455.0 KHz
-17.54 dBm

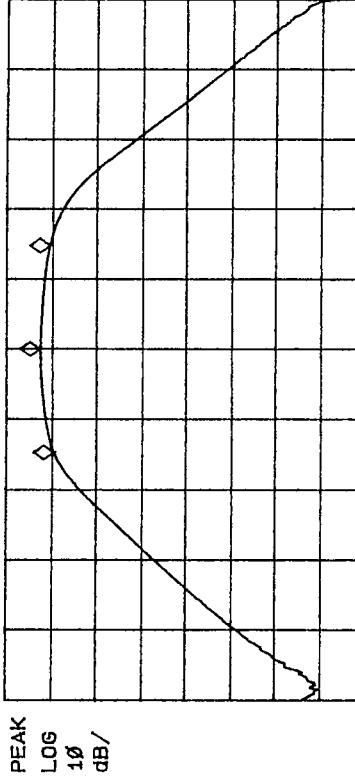

1. IN
 same as A
 2. OUT
 same as A

Marker	Trace Type	Freq / Time	Amplitude
1:	(A) Freq	0.3444 MHz	-20.63 dBm
2:	(A) Freq	0.4550 MHz	-17.54 dBm
3:	(A) Freq	0.5656 MHz	-19.69 dBm
4:	Inactive		

CENTER 455.0 KHz
 RES BW 10 KHz
 VBM 10 KHz
 SPAN 750.0 KHz
 SWP 30.0 msec

129.900 MHz FM
 AGC = 0 FA

FRONT-RF UNIT

Part	Used	PartType	Designators
------	------	----------	-------------

1	1	0.5pF (Cer)	C288
2	3	1pF (Cer)	C82 C89 C413
3	1	2pF (Cer)	C121
4	1	3pF (Cer)	C410
5	2	4pF (Cer)	C52 C367
6	2	5pF (Cer)	C141 C142
7	2	6pF (Cer)	C85 C144
8	1	7pF (Cer)	C47
9	4	10pF (Cer)	C294 C295 C303 C369
10	1	20pF (CV05D2001)	TC1
11	1	22pF (Cer)	C114
12	3	33pF (Cer)	C102 C117 C135
13	1	39pF (Cer)	C205
14	1	43pF (Cer)	C97
15	1	47pF (Cer)	C134
16	14	100pF(Cer)	C45 C68 C70 C71 C74 C75 C79 C94 C137 C139 C261 C262 C263 C264
17	2	150pF(Cer)	C107 C191
18	1	270pF(Cer)	C368
19	39	330pF(Cer)	C46 C48 C49 C50 C51 C53 C54 C55 C56 C57 C58 C59 C62 C63 C65 C69 C72 C73 C78 C81 C83 C87 C90 C122 C131 C302 C309 C310 C372 C377 C384 C386 C388 C392 C393 C394 C395 C396 C397
20	1	470pF(Cer)	C186
21	13	1nF (Cer)	C64 C77 C84 C88 C95 C96 C100 C138 C140 C145 C290 C349 C373
22	2	4.7nF (Cer)	C234 C237
23	51	10nF (Cer)	C2 C5 C8 C20 C67 C104 C105 C108 C109 C111 C115 C118 C119 C128 C130 C132 C136 C146 C155 C156 C157 C158 C159 C160 C161 C163 C164 C166 C217 C219 C221 C223 C225 C227 C265 C267 C268 C269 C270 C277 C304 C362 C363 C364 C365 C376 C385 C389 C390 C398 C399
24	2	12nF (Cer)	C235 C236
25	22	0.1uF(Cer)	C143 C162 C165 C167 C168 C169 C170 C171 C172 C173 C174 C175 C176 C177 C178 C179 C180 C181 C182 C183 C184 C378
26	4	1uF (Cer)	C185 C188 C189 C192
27	41	2.2uF(Cer)	C187 C190 C202 C203 C204 C206 C207 C208 C209 C210 C211 C212 C213 C229 C230 C231 C232 C233 C238 C239 C240 C241 C242 C257 C258 C259 C260 C275 C276 C305 C306 C307 C308 C379 C380 C381 C382 C383 C391 C400 C401
28	1	100uF/16V (Ele)	C412
29	1	100uF/35V (Ele)	C272
30	2	220uF/6.3V(Ele)	C271 C274
31	1	220uF/16V (Ele)	C273
32	4	0	R296 R297 R351 R352
33	7	10	R55 R71 R136 R143 R231 R240 R358
34	1	15	R142
35	6	22	R135 R230 R313 R315 R354 R242
36	4	27	R309 R310 R340 R342
37	3	36	R308 R314 R341
38	5	47	R4 R5 R10 R11 R58
39	4	100	R68 R69 R74 R75

40	7	220	R155 R165 R176 R186 R196 R206 R259
41	1	330	R311
42	1	430	R238
43	6	470	R132 R224 R343 R344 R361 R362
44	2	560	R232 R233
45	3	680	R133 R140 R228
46	42	1K	R32 R40 R50 R51 R57 R60 R61 R70 R78 R79 R89 R96 R107 R108 R115 R120 R130 R137 R139 R144 R162 R174 R184 R194 R204 R213 R226 R234 R235 R243 R261 R304 R306 R307 R312 R316 R317 R339 R353 R355 R357 R363
47	1	1K(Axi)	R376
48	1	1.5K	R239
49	3	2.2K	R62 R77 R289
50	3	2.7K	R134 R141 R229
51	1	3.3K	R290
52	2	4.7K	R291 R292
53	1	8.2K	R288
54	25	10K	R54 R56 R208 R209 R211 R212 R278 R279 R280 R293 R295 R345 R346 R347 R348 R349 R350 R364 R365 R366 R367 R368 R369 R371 R373
55	1	10K(RH0421C14J10K)	VR3
56	1	15K	R294
57	4	22K	R181 R191 R201 R210
58	2	39K	R66 R72
59	8	47K	R48 R49 R95 R102 R119 R126 R159 R170
60	35	100K	R34 R37 R42 R47 R65 R67 R73 R76 R88 R90 R94 R98 R100 R109 R117 R122 R129 R167 R173 R178 R179 R180 R182 R183 R188 R189 R190 R192 R193 R198 R199 R200 R202 R203 R281
61	32	220K	R35 R36 R38 R39 R43 R44 R45 R46 R87 R91 R92 R93 R103 R104 R105 R106 R110 R111 R113 R114 R123 R124 R127 R128 R157 R158 R160 R161 R168 R169 R171 R172
62	37	470K	R33 R41 R59 R63 R81 R82 R86 R97 R101 R116 R118 R121 R131 R138 R145 R156 R164 R166 R175 R177 R185 R187 R195 R197 R205 R207 R214 R227 R236 R244 R245 R260 R262 R359 R370 R372 R374
63	1	RKM10L203G	RN2
64	2	2d3t	L63 L150
65	1	2d4t	L65
66	3	2d5t	L29 L119 L120
67	2	2.5d2t	L23 L24
68	2	4d3t	L41 L42
69	2	4d5t	L45 L46
70	2	5d0.5t	L20 L21
71	1	10nH	L28
72	1	12nH	L165
73	1	15nH	L33
74	1	17nH	L35
75	2	23nH	L32 L34
76	1	47nH	L61
77	2	560nH	L64 L92
78	1	3.9uH	L82
79	3	10uH	L30 L31 L157
80	1	27uH	L98
81	1	33uH	L99
82	1	39uH	L100

83	1	220uH(Rad)	L111
84	17	330uH	L39 L44 L47 L48 L52 L53 L58 L62 L66 L71 L72 L89 L151 L152 L156 L163 L164 L73 L74 L75 L76 L77 L78 L79 L80 L81 L83
85	10	470uH	L88 L90 L93 L94 L95 L97 L101 L153 L91 L121 L122 L123
86	8	560uH	L19 L22 L25 L26 L36 L37 L102 L103 L104 L105 L106 L108 L109 L110 L159 L161 L162 L154
87	4	2.2mH	D1 D3 D5 D6 D49 D53 D238 D241 D242 D275
88	18	BLM21A121	D106 D118 D138 D152 D167 D182 D239 D263
89	10	1S2837	D46 D47 D74 D84 D102 D104 D117 D151 D166 D181 D200 D230 D231 D232 D240 D243 D246 D247 D259 D280
90	8	1SS244	D21 D30 D103 D233 D260 D277 D289 D50 D51 D52 D54 D56 D65 D75 D85 D252 D261 D262 D266 D267 D276 D278
91	20	1SS269	D139 D140 D141 D142 D143 D144 D146 D147 D148 D149 D150 D153 D154 D155 D156 D157 D158 D159 D161 D162 D163 D164 D165 D168 D169 D170 D171 D172 D173 D174 D175 D176 D177 D178 D179 D180 D183 D184 D185 D186 D187 D188 D189 D191 D195 D197 D199 D256 D257 D258 D290
92	7	RN731V	D31 D32 D33 D34 D42 D43 D45 D57 D58 D59 D60 D61 D62 D63 D64 D283 D284 D297 D298
93	15	1SV196	D22 D23 D24 D25 D26 D27 D28 D29 D35 D37 D41 D44 D286 D287
94	51	1SV102	D66 D67 D68 D69 D70 D71 D72 D73 D76 D77 D78 D79 D80 D81 D82 D83 D86 D88 D90 D92 D93 D95 D96 D97 D98 D99 D100 D101 D107 D108 D109 D110 D111 D112 D113 D114 D115 D116 D119 D120 D121 D122 D123 D124 D125 D126 D127 D128 D129 D130 D131 D132 D133 D134 D135 D136 D137 D264 D265 D281 D282 D291 D292 D293 D294 D295 D296
95	19	HVU202A	Q22
96	14	1SV214	Q24 Q42 Q45
97	8	1SV229	Q13 Q14
98	59	HVU300A	Q10
99	1	2SC3357	Q5 Q6 Q7 Q8 Q11 Q12 Q15 Q16 Q17 Q18 Q19 Q20 Q21 Q23 Q25 Q27 Q28 Q29 Q30 Q31 Q32 Q33 Q34 Q35 Q36 Q37 Q38 Q41 Q43 Q44 Q46 Q47 Q48 Q50 Q51 Q52 Q53
100	3	2SC4536	IC3 IC4 IC6 IC7 IC10 IC11 IC13 IC14 IC15 IC16 IC17 IC18 IC19 IC20 IC24 IC25 IC26 IC27 IC28 IC29 IC32 IC33 IC37 IC38 IC39 IC40 IC52 IC53 IC59 IC60 IC61
101	2	3SK232	IC56
102	1	FSX027WF	IC41 IC42 IC43 IC44 IC45 IC46
103	37	DTC124EK	IC57
104	31	FMC5	IC58
105	1	uPD74HC4051G	T4
106	6	uPD4094BG	T5
107	1	NIS-164	T6
108	1	NIS-165	T7
109	1	KE-07645	
110	1	KE-07646	
111	1	KE-07647	
112	1	KE-07648	

113	1	KE-07649	T8
114	1	KE-07780	T12
115	2	KE-07790	T2 T3
116	1	KE-07793	T10
117	1	KE-07804	T11
118	2	NIS-501	DBM1 DBM3
119	1	NIS-502	DBM2
120	5	RK1-9V	K1 K2 K5 K6 K7
121	1	(M-TYPE)	ANT2
122	1	(N-TYPE)	ANT1
123	1	MM3325-2505	J6
124	1	PI22A06M	J4
125	1	PI28A02M	J5
126	1	PI28A08M	J3
127	2	TMP-J01X-V6	J1 J2
128	1	JP-No.109	JP1

CPU UNIT

Part Used PartType Designators

Part	Used	PartType	Designators
1	1	10pF(Cer)	C65
2	1	20pF(Cer)	C23
3	1	20pF(CV05D2001)	TC1
4	2	33pF(Cer)	C22 C24
5	34	101 (Cer)	C6 C7 C15 C16 C17 C18 C19 C20 C21 C26 C27 C28 C29 C33 C34 C35 C36 C37 C38 C40 C41 C42 C43 C44 C45 C46 C47 C48 C49 C53 C54 C64 C77 C80
6	24	102 (Cer)	C1 C2 C3 C4 C5 C8 C9 C10 C11 C12 C13 C14 C30 C31 C32 C39 C50 C51 C52 C58 C63 C67 C70 C78
7	6	0.1uF(Cer)	C59 C60 C61 C62 C69 C71
8	4	100uF/10V (Ele)	C73 C74 C75 C79
9	1	470uF/6.3V(Ele)	C72
10	1	10	R20
11	1	1K	R10
12	4	33K	R70 R71 R72 R73
13	19	100K	R4 R9 R13 R14 R15 R16 R17 R18 R19 R56 R57 R59 R60 R61 R62 R63 R64 R65 R69
14	8	220K	R1 R2 R3 R5 R6 R7 R8 R12
15	1	560K	R58
16	55	BLM21A121	L5 L6 L7 L8 L9 L10 L11 L12 L14 L15 L16 L17 L18 L19 L20 L21 L22 L23 L24 L25 L26 L27 L28 L29 L30 L31 L32 L33 L34 L35 L36 L37 L38 L39 L40 L41 L42 L43 L47 L48 L49 L50 L51 L52 L53 L54 L55 L56 L57 L58 L59 L60 L61 L62 L63
17	3	HN2D01F	D1 D2 D5
18	2	RB500V-40	D3 D4
19	1	DTC323TK	Q1
20	1	S-8052HNM	IC1
21	1	TC4W66F	IC2
22	1	uPD74HC373GS	IC5
23	1	uPD78P064GF	IC3
24	1	uPD16430AGF	IC4
25	1	32.768Kz	X1
26	1	4.9152MHz	X2
27	1	D2213	BL1
28	1	DLC-3069PYNGF	LCD1
29	25	SKHHBV	S2 S3 S4 S5 S6 S7 S8 S9 S10 S11 S12 S13 S14 S15 S16 S17 S18 S19 S20 S21 S22 S23 S24 S25 S26
30	1	SKHHBY	S1
31	1	SKHLAC	S27
32	1	PI28A02M	J8
33	1	PI28A05M	J3
34	1	PI28A06M	J2
35	1	PI28A09M	J5
36	1	PI28A10M	J6
37	1	PI28A11M	J4
38	1	PI28A13M	J1
39	1	PI28G15M	J7
40	1	JP-No.101	JP1
41	1	JP-No.102	JP2
42	1	JP-No.103	JP3

PLL UNIT

Part	Used	PartType	Designators
1	2	0.5pF(Cer)	C111 C173
2	5	1.5pF(Cer)	C100 C110 C131 C132 C150
3	6	1pF (Cer)	C92 C93 C94 C105 C108 C141
4	5	2pF (Cer)	C103 C109 C112 C117 C135
5	5	3pF (Cer)	C104 C133 C138 C140 C172
6	8	4pF (Cer)	C75 C86 C113 C115 C120 C124 C139 C145
7	5	5pF (Cer)	C72 C83 C107 C114 C137
8	5	6pF (Cer)	C121 C122 C123 C146 C148
9	2	7pF (Cer)	C102 C136
10	4	8pF (Cer)	C74 C84 C85 C147
11	1	9pF (Cer)	C73
12	3	10pF (Cer)	C71 C76 C134
13	3	20pF (Cer)	C99 C187 C193
14	2	47pF (Cer)	C234 C235
15	1	68pF (Cer)	C218
16	40	100pF(Cer)	C1 C2 C4 C5 C6 C7 C8 C11 C12 C14 C26 C45 C52 C53 C54 C64 C65 C79 C80 C91 C95 C96 C97 C98 C116 C118 C125 C128 C129 C130 C143 C144 C149 C151 C152 C155 C176 C180 C181 C209
17	1	150pF(Cer)	C200
18	1	270pF(Cer)	C201
19	31	330pF(Cer)	C13 C77 C78 C81 C101 C106 C119 C126 C127 C142 C153 C154 C156 C157 C158 C159 C160 C161 C162 C163 C164 C165 C166 C167 C168 C169 C170 C171 C238 C239 C240
20	3	470pF(Cer)	C207 C230 C231
21	6	1nF (Cer)	C44 C82 C206 C229 C236 C237
22	2	2.2nF (Cer)	C203 C204
23	1	3.3nF (Cer)	C205
24	29	10nF (Cer)	C10 C30 C35 C37 C40 C41 C42 C43 C56 C58 C61 C62 C63 C89 C90 C194 C195 C197 C198 C199 C208 C223 C224 C225 C226 C227 C228 C232 C233
25	18	0.1uF(Cer)	C9 C32 C34 C50 C60 C69 C88 C182 C183 C184 C185 C188 C189 C190 C191 C192 C196 C221
26	1	0.1uF/35V (Tan)	C215
27	6	1uF/16V (Tan)	C25 C46 C47 C48 C49 C179
28	4	2.2uF/6.3V (Tan)	C16 C17 C177 C213
29	8	2.2uF/16V (Tan)	C15 C18 C19 C22 C23 C24 C38 C211
30	3	2.2uF/35V (Tan)	C28 C29 C55
31	1	10uF/16V (Ele)	C210
32	1	100uF/6.3V(Ele)	C214
33	4	100uF/10V (Ele)	C21 C31 C33 C222
34	6	100uF/16V (Ele)	C20 C51 C59 C70 C87 C212
35	1	100uF/35V (Ele)	C27
36	2	220uF/10V (Ele)	C67 C68
37	1	220uF/16V (Ele)	C66
38	1	0	R111
39	6	3.3	R14 R16 R51 R52 R54 R55
40	4	10	R47 R62 R64 R82
41	4	22	R13 R50 R59 R60
42	2	39	R118 R119
43	5	47	R49 R65 R66 R72 R80
44	2	68	R53 R57
45	3	100	R58 R122 R139
46	1	150	R63

47	4	220	R1 R101 R105 R145
48	5	470	R15 R48 R56 R102 R117
49	1	560	R133
50	36	1K	R4 R5 R17 R18 R19 R20 R24 R25 R27 R28 R32 R34 R35 R36 R37 R38 R39 R40 R61 R67 R68 R69 R70 R71 R73 R74 R81 R83 R84 R85 R96 R97 R107 R126 R127 R130
51	6	2.2K	R2 R3 R6 R12 R98 R116
52	2	2.7K	R114 R115
53	2	3.3K	R108 R125
54	3	4.7K	R23 R26 R146
55	1	5.6K	R112
56	20	10K	R7 R22 R29 R45 R93 R95 R103 R104 R106 R110 R135 R136 R137 R138 R140 R141 R142 R143 R144 R147
57	2	12K	R8 R10
58	1	18K	R113
59	1	22K	R123
60	2	33K	R21 R30
61	6	47K	R41 R42 R43 R44 R99 R100
62	4	100K	R11 R31 R33 R148
63	8	220K	R46 R75 R76 R77 R78 R79 R128 R129
64	1	1M	R9
65	1	1d1t	L28
66	15	1d2t	L26 L27 L29 L30 L31 L32 L33 L35 L36 L44 L45 L47 L48 L49 L55
67	3	1d3t	L34 L38 L58
68	5	1.5d2t	L43 L46 L51 L52 L54
69	5	1.5d3t	L39 L40 L41 L42 L50
70	2	8.8nH	L20 L53
71	8	15nH	L9 L15 L16 L17 L18 L19 L25 L37
72	2	680nH	L67 L68
73	1	3.3uH	L69
74	2	5.6uH	L65 L66
75	2	10uH	L60 L61
76	3	100uH	L59 L63 L64
77	1	470uH	L62
78	16	BLM21A121	L1 L2 L3 L4 L5 L6 L7 L8 L10 L11 L12 L13 L14 L22 L23 L24
79	1	1S2837	D19
80	1	HVU300A	D23
81	7	1SV196	D1 D2 D3 D4 D20 D24 D25
82	1	RD5.6MB2	D9
83	3	RD8.2MB2	D5 D8 D22
84	9	RN731V	D10 D11 D12 D13 D14 D15 D16 D17 D18
85	3	HN2D01F	D6 D7 D21
86	2	2SA812	Q3 Q7
87	2	2SC1009A	Q36 Q39
88	18	2SC1623	Q1 Q2 Q4 Q5 Q6 Q8 Q9 Q10 Q11 Q12 Q13 Q14 Q15 Q16 Q17 Q22 Q34 Q35
89	1	2SC2759	Q44
90	1	2SC3356	Q38
91	8	DTC124EK	Q28 Q29 Q30 Q31 Q32 Q37 Q41 Q42
92	1	DTC323TK	Q43
93	11	FMC5	Q18 Q19 Q20 Q21 Q23 Q24 Q25 Q26 Q27 Q33 Q40
94	1	MB1501PF	IC1
95	2	MB1504PF	IC3 IC17
96	1	S-80840ANUP	IC16
97	1	TC4S81F	IC2
98	2	uPC1675G	IC7 IC10
99	1	uPC1676G	IC8
100	6	uPC2709T	IC6 IC9 IC11 IC12 IC13 IC14

101	1	uPD4017BG	IC18
102	2	uPD4094BG	IC4 IC5
103	1	NIS-501	DBM1
104	1	NIS-503	FDB1
105	1	NIS-504	VCO4
106	1	NIS-507	TCXO1
107	1	NIS-150	NCO1
108	1	CSA4.60MG040	CX1
109	2	KE-07495	T1 T2
110	1	KE-07631	T3
111	1	PI22A07M	J6
112	1	PI28A08M	J7
113	1	PI28A09M	J5
114	1	PI28A10M	J8
115	1	PI28A09F	F1
116	1	MM3325-2505	J1
117	3	TMP-J01X-V6	J2 J3 J4
118	1	JP-No.6	JP1

NCO UNIT(NIS-150)

Part	Used	PartType	Designators
1	1	20pF (TZBX4R200BA110)	C17
2	1	43pF(Cer)	C16
3	1	47pF(Cer)	C15
4	1	68pF (Cer Rad)	C18
5	1	120pF(Cer Rad)	C19
6	2	470pF(Cer)	C3 C4
7	1	560pF(Cer)	C2
8	1	680pF(Cer)	C1
9	4	10nF (Cer)	C7 C9 C12 C13
10	6	0.1uF(Cer)	C5 C6 C8 C10 C11 C14
11	1	47	R4
12	1	1K	R3
13	1	2.2K	R2
14	1	33K	R1
15	1	1uH	L1
16	3	1.8uH	L2 L3 L4
17	1	HA19510MP	IC1
18	1	TC7W04F	IC3
19	1	NIS-506	IC2
20	1	16.777216MHz	X1
21	1	9205B-1-13A-T	P1

IF UNIT

Part	Used	PartType	Designators
1	1	1pF (Cer)	C39
2	1	3pF (Cer)	C38
3	2	4pF (Cer)	C177 C178
4	3	5pF (Cer)	C34 C167 C168
5	2	8pF (Cer)	C32 C215
6	7	10pF (Cer)	C18 C27 C29 C61 C66 C196 C218
7	4	12pF (Cer)	C37 C175 C176 C214
8	4	15pF (Cer)	C42 C44 C96 C217
9	2	18pF (Cer)	C23 C33
10	1	22pF (Cer)	C113
11	1	25pF (TZBX4Z250BB110) TC1	
12	6	33pF (Cer)	C144 C145 C148 C149 C152 C153
13	4	39pF (Cer)	C28 C59 C81 C216
14	6	47pF (Cer)	C17 C64 C69 C80 C120 C201
15	2	56pF (Cer)	C172 C173
16	3	100pF(Cer)	C47 C50 C87
17	1	220pF(Cer)	C121
18	1	270pF(Cer)	C90
19	3	330pF(Cer)	C101 C106 C111
20	13	1nF (Cer)	C25 C53 C71 C79 C100 C103 C108 C115 C123 C124 C164 C165 C166
21	1	1.2nF(Cer)	C197
22	1	2.2nF(Cer)	C198
23	1	3.3nF(Cer)	C199
24	68	10nF (Cer)	C1 C2 C3 C4 C5 C6 C12 C13 C14 C16 C19 C20 C22 C24 C26 C30 C31 C35 C36 C40 C41 C45 C46 C48 C49 C51 C52 C55 C56 C57 C60 C63 C65 C68 C70 C72 C73 C74 C122 C135 C136 C137 C138 C139 C171 C179 C180 C181 C182 C183 C184 C187 C188 C189 C190 C191 C192 C193 C202 C203 C204 C205 C206 C207 C208 C209 C210 C211
25	1	33nF (Cer)	C200
26	49	0.1uF (Cer)	C15 C21 C54 C62 C67 C75 C77 C84 C85 C86 C88 C89 C91 C92 C93 C94 C95 C97 C98 C99 C102 C104 C105 C107 C109 C110 C112 C118 C119 C140 C141 C142 C143 C146 C147 C150 C151 C154 C155 C156 C157 C158 C159 C160 C161 C162 C163 C170 C219
27	1	0.22uF(Cer)	C78
28	2	0.22uF/35V(Tan)	C76 C132
29	5	1uF (Cer)	C114 C116 C117 C125 C126
30	3	1uF/16V (Tan)	C114 C116 C117 C125 C126 C127 C130 C133
31	1	2.2uF/50V (Ele)	C131
32	6	10uF/16V (Ele)	C128 C129 C134 C194 C195 C213
33	1	100uF/16V(Ele)	C11
34	4	220uF/10V(Ele)	C8 C9 C10 C83
35	1	470uF/16V(Ele)	C7
36	5	0	R62 R198 R203 R248 R279
37	2	47	R12 R18
38	18	100	R17 R23 R29 R35 R41 R47 R53 R68 R74 R94 R161 R176 R181 R186 R191 R196 R201 R206
39	1	150(Axi)	R281
40	25	220	R6 R10 R20 R26 R32 R38 R44 R50 R58 R66 R88 R115 R117 R122 R124 R129 R131

			R139 R174 R179 R184 R189 R194 R199
			R204
41	5	330	R21 R45 R51 R72 R193
42	2	470	R4 R5
43	3	560	R16 R43 R49
44	2	680	R101 R136
45	6	820	R27 R33 R46 R173 R262 R263
46	19	1K	R22 R59 R73 R75 R76 R77 R100 R106 R108
			R132 R133 R141 R142 R144 R145 R151 R152
			R183 R188
47	1	1K (Axi)	R276
48	2	1.2K	R102 R105
49	1	1.2K(Axi)	R274
50	5	1.5K	R28 R40 R52 R178 R205
51	1	1.5K(Axi)	R280
52	1	1.8K	R200
53	13	2.2K	R11 R42 R48 R61 R89 R116 R123 R130 R137
			R187 R202 R271 R273
54	1	2.7K	R107
55	8	3.3K	R36 R67 R118 R125 R185 R192 R197 R272
56	1	3.9K	R195
57	15	4.7K	R24 R30 R34 R54 R87 R95 R164 R172 R177
			R180 R182 R190 R207 R236 R252
58	1	4.7K(Axi)	R171
59	2	6.8K	R216 R217
60	4	8.2K	R147 R153 R175 R240
61	27	10K	R2 R9 R15 R57 R65 R71 R90 R92 R98 R114
			R121 R128 R134 R140 R143 R166 R168
			R227 R228 R232 R237 R238 R239 R251
			R270 R277 R278
62	1	10K (Axi)	R275
63	6	10K(RH0421C14J10K)	VR1 VR2 VR3 VR4 VR6 VR7
64	1	10K(RVG4M08-103VM)	VR8
65	2	12K	R55 R150
66	4	15K	R103 R155 R218 R234
67	4	18K	R91 R170 R249 R269
68	1	20K	R235
69	4	22K	R97 R148 R253 R254
70	4	27K	R13 R126 R219 R247
71	6	33K	R7 R63 R112 R119 R242 R256
72	5	39K	R1 R3 R69 R157 R220
73	2	43K	R158 R241
74	4	47K	R149 R159 R221 R222
75	1	47K(RH0421CS4J47K)	VR5
76	1	56K	R96
77	3	68K	R154 R156 R250
78	1	82K	R93
79	29	100K	R8 R14 R56 R64 R70 R85 R109 R110 R111
			R113 R120 R127 R138 R146 R162 R163
			R165 R167 R229 R230 R231 R233 R243
			R244 R245 R246 R255 R257 R268
80	23	220K	R78 R79 R80 R81 R82 R83 R84 R99 R104
			R135 R160 R169 R208 R209 R210 R211
			R212 R213 R214 R215 R223 R225 R226
81	2	560K	R86 R224
82	1	RKM10L203G	NR1
83	4	10uH	L1 L2 L3 L4
84	5	1S2837	D16 D18 D19 D20 D40
85	1	1SS268	D21
86	6	1SV196	D3 D4 D7 D8 D9 D12
87	2	HN2D01F	D17 D22
88	1	RB500V-40	D41
89	23	RN731V	D1 D2 D5 D6 D10 D11 D13 D14 D15 D26

			D27 D28 D29 D30 D31 D32 D33 D34 D35
			D36 D37 D38 D39
90	2	ND411G-1	D24 D25
91	1	ND487C1T	D23
92	1	2SC1009A	Q29
93	3	2SC1623	Q28 Q31 Q32
94	1	2SC2787	Q40
95	1	2SK520	Q3
96	8	3SK131	Q4 Q5 Q6 Q7 Q8 Q25 Q26 Q27
97	20	DTC124EK	Q1 Q2 Q9 Q10 Q11 Q12 Q13 Q14 Q15 Q20 Q21 Q22 Q30 Q33 Q34 Q35 Q36 Q37 Q38 Q39
98	1	F2	PI28A10F
99	6	FMC5	Q16 Q17 Q18 Q19 Q23 Q24
100	4	TC4W53F	IC19 IC21 IC24 IC28
101	2	TC7S66F	IC11 IC18
102	1	UPC4570G	IC29
103	5	uPC358G	IC6 IC10 IC20 IC22 IC23
104	2	uPC4570G	IC14 IC15
105	1	uPD74HC238G	IC9
106	1	uPD74HC4051G	IC13
107	3	uPD74HC4052G	IC25 IC26 IC30
108	3	uPD74HC4066G	IC12 IC16 IC17
109	5	uPD4094BG	IC1 IC2 IC3 IC4 IC5
110	1	uPD4528BG	IC7
111	1	MC3372M	IC8
112	1	NIS-157	IC27
113	1	NIS-158	IC31
114	1	10.245MHz	X1
115	2	10M03B	XF1 XF2
116	2	10M06B	XF3 XF4
117	2	10M15B	XF5 XF6
118	2	10M30B	XF7 XF8
119	1	SFE10.7MHYK-A	CF5
120	1	SFE10.7MS2A10K-A	CF6
121	1	526-8693-010	MF1(OP)
122	1	526-8694-010	MF2(OP)
123	1	526-8695-010	MF3(OP)
124	1	CDB455C16	CD1
125	1	CFJ455K5	CF1
126	1	CFWS455G	CF3
127	1	CFWS455E	CF4
128	1	SFH455B	CF2
129	1	NIS-155	LCF1
130	1	NIS-156	LCF2
131	4	KE-04980	T9 T10 T11 T12
132	1	KE-07651	T1
133	4	KE-07791	T2 T6 T7 T8
134	3	KE-07792	T3 T4 T5
135	1	PI22A06M	J1
136	1	PI28A02M	J11
137	1	PI28A03M	J4
138	1	PI28A07M	J5
139	1	PI28A08M	J6
140	1	PI28A09M	J3
141	1	PI28A11M	J2
142	1	PI28A08F	F1
143	1	PI28A10F	F2
144	1	IMSA-9110B-07	J10
145	3	TMP-J01X-V6	J7 J8 J9
146	1	JP-No.1	JA
147	1	JP-No.2	JB
148	1	JP-No.3	JC

149	1	JP-No.4	JD
150	1	JP-No.5	JE
151	1	JP-No.117	JF
152	1	JP-No.107	JG
153	1	JP-No.106	JH
154	1	JP-No.126	JI
155	1	JP-No.127	JJ

455FILA UNIT(NIS-155 BW=100kHz)

Part	Used	PartType	Designators
1	1	180pF(Cer)	C5
2	2	220pF(Cer)	C4 C9
3	2	270pF(Cer)	C2 C7
4	5	330pF(Cer)	C3 C6 C8 C10 C11
5	2	0.1uF (Cer)	C1 C12
6	1	220	R1
7	2	56uH	L3 L5
8	2	68uH	L1 L7
9	2	82uH	L2 L6
10	1	270uH	L4
11	2	330uH	L8 L9
12	5	010-1.2-P	P1 P2 P3 P4 P5

455FILB UNIT(NIS-156 BW=220kHz)

Part	Used	PartType	Designators
1	2	180pF(Cer)	C4 C5
2	5	220pF(Cer)	C2 C3 C6 C7 C9
3	3	330pF(Cer)	C8 C10 C11
4	2	0.1uF (Cer)	C1 C12
5	1	220	R1
6	2	68uH	L1 L7
7	2	82uH	L2 L6
8	2	150uH	L3 L5
9	1	270uH	L4
10	2	330uH	L8 L9
11	5	010-1.2-P	P1 P2 P3 P4 P5

AUDIOBPF UNIT(NIS-157)

Part	Used	PartType	Designators
1	2	47pF (Cer)	C17 C18
2	1	470pF(Cer)	C21
3	1	8.2nF(Cer)	C20
4	12	10nF (Cer)	C4 C5 C6 C7 C8 C9 C10 C11 C12 C13 C14 C15
5	3	22nF (Cer)	C1 C2 C3
6	1	33nF (Cer)	C22
7	2	1uF (Cer)	C16 C19
8	1	0	R14
9	1	1.8K	R21
10	1	2.2K	R25
11	1	2.7K	R29
12	1	3.3K	R9
13	1	3.9K	R17
14	2	5.1K	R20 R28
15	1	5.6K	R24
16	1	6.8K	R8
17	3	8.2K	R19 R23 R27
18	3	10K	R18 R22 R26
19	1	12K	R6
20	1	15K	R5
21	2	22K	R4 R7
22	2	47K	R2 R16
23	2	62K	R1 R15
24	1	82K	R3
25	4	100K	R30 R31 R32 R33
26	1	220K	R13
27	1	270K	R12
28	1	390K	R11
29	1	1.5M	R10
30	2	uPC4570G	IC5 IC6
31	4	uPD74HC4052G	IC1 IC2 IC3 IC4
32	1	9205B-1-04Z002-T	P1
33	2	9205B-1-04Z-T	P2 P3

AUDIO UNIT

Part	Used	PartType	Designators
1	2	36pF (Cer)	C8 C9
2	1	100pF(Cer)	C50
3	3	330pF(Cer)	C12 C21 C49
4	1	1.8nF (Cer)	C45
5	1	5.6nF (Cer)	C39
6	19	10nF (Cer)	C3 C4 C5 C6 C7 C14 C15 C17 C18 C19 C23 C24 C25 C46 C51 C52 C59 C60 C63
7	1	22nF (Cer)	C40
8	12	0.1uF(Cer)	C1 C2 C10 C11 C13 C20 C22 C26 C42 C47 C57 C58
9	3	1uF/16V (Tan)	C31 C61 C62
10	6	2.2uF/6.3V (Tan)	C29 C30 C32 C41 C43 C44
11	2	4.7uF/6.3V (Tan)	C27 C48
12	1	10uF/6.3V (Tan)	C28
13	4	10uF/16V (Ele)	C36 C53 C54 C56
14	3	100uF/16V (Ele)	C34 C35 C55
15	2	470uF/16V (Ele)	C37 C38
16	2	470	R13 R46
17	7	1K	R1 R7 R9 R18 R19 R40 R43
18	1	1.5K	R31
19	1	2.2K	R48
20	1	5.6K	R47
21	4	10K	R5 R12 R16 R29
22	5	22K	R4 R15 R32 R33 R34
23	7	47K	R6 R23 R24 R25 R26 R27 R28
24	7	100K	R2 R17 R22 R35 R41 R44 R45
25	3	220K	R3 R30 R36
26	1	330K	R20
27	2	470K	R10 R11
28	1	560K	R21
29	1	1S2837	D1
30	1	ND411G-1	D2
31	2	RB500V-40	D3 D4
32	1	2SK160	Q2
33	2	2SK680	Q1 Q7
34	1	FMC5	Q5
35	1	TC4S81F	IC13
36	1	TC4SU69F	IC6
37	2	TC4W53F	IC1 IC3
38	1	uPC358G	IC9
39	2	uPC4570G	IC5 IC10
40	1	LA4425A	IC4
41	1	LC73881M	IC12
42	1	AQV212A	IC8
43	1	BA1604F	IC11
44	1	BH3532FS	IC2
45	1	CSA4.19MG	CX1
46	1	PI22A02M	J3
47	1	PI22A03M	J2
48	1	PI22A04M	J1
49	1	PI22A05M	J5
50	1	PI28A03M	J6
51	1	PI28A07M	J7
52	1	PI28A08M	J8
53	1	PI28A13M	J4
54	1	JP-No.7	JP1
55	1	JP-No.108	JP2

VR UNIT

Part	Used	PartType	Designators
1	1	10KC(RK0971110-10KC)	VR2
2	1	50KA(RK0971110-50KA)	VR1
3	1	PI28B06M	J1

CPUSUB UNIT

Part	Used	PartType	Designators
1	5	0.1uF (Cer)	C2 C4 C5 C6 C7
2	1	100uF/10V(Ele)	C1
3	1	0.47F/5.5V(Ele)	C3
4	1	10	R1
5	2	10K	R4 R5
6	2	100K	R2 R3
7	1	HN58C1001FP-15	IC3
8	1	TC4SU69F	IC4
9	2	uPD74HC373GS	IC1 IC2
10	1	PI28A15M	J1

CTCSS UNIT(NIS-158)

Part	Used	PartType	Designators
1	2	18pF (Cer)	C7 C8
2	1	82pF (Cer)	C3
3	1	100pF(Cer)	C10
4	1	1nF (Cer)]	C2
5	3	0.1uF (Cer)	C1 C4 C6
6	2	1uF/16v (Tan)	C11 C12
7	1	4.7uF/6.3V(Tan)	C9
8	1	10uF/16V (Ele)	C5
9	1	5.6K	R13
10	1	10K	R8
11	1	15K	R10
12	1	47K	R7
13	1	68K	R5
14	3	100K	R1 R2 R3
15	1	120K	R4
16	2	270K	R6 R14
17	1	330K	R11
18	1	1M	R12
19	1	HN2D01F	D1
20	1	AK2341	IC1
21	1	3.6864MHz	X1
22	1	9205B-1-12002-TA	P1

POWER UNIT

Part	Used	PartType	Designators
1	7	0.1uF(Cer)	C1 C3 C13 C14 C16 C17 C21
2	2	10uF/16V (Ele)	C2 C15
3	3	100uF/10V (Ele)	C5 C9 C10
4	2	100uF/16V (Ele)	C11 C12
5	2	100uF/10V (Os)	C7 C20
6	2	150uF/16V (Os)	C4 C6
7	2	220uF/35V (Ele)	C18 C19
8	1	2200uF/16V(Ele)	C8
9	1	3.3	R9
10	1	2.2K	R6
11	2	4.7K	R7 R8
12	1	10K	R4
13	1	22K	R1
14	1	33K	R5
15	2	47K	R2 R3
16	3	220uH(Rad)	L1 L2 L3
17	1	220uH	L4
18	2	1S2837	D1 D3
19	1	3GWJ42	D2
20	1	2SB624	Q3
21	1	2SJ330	Q1
22	2	DTA123YK	Q4 Q5
23	1	DTC124EK	Q2
24	1	S-80840ANUP	IC1
25	2	S-81252SGUP	IC4 IC5
26	1	TA79L05F	IC6
27	1	KPL108	IC2
28	1	KPL130	IC3
29	1	FUUSE2A	FH1
30	1	PI22A02M	J4
31	1	PI22A05M	J2
32	1	PI22A06M	J1
33	1	PI22A07M	J3
34	1	PI22A08M	J7
35	1	PI22A09M	J5
36	1	PI28A09M	J6
37	1	JP-No.105	JP1
38	1	JP-No.104	JP2

POWERSUB UNIT

Part	Used	PartType	Designators
1	6	0.1uF(Cer)	C1 C2 C3 C4 C5 C6
2	1	uPC7805AHF	IC1
3	1	uPC78M06AHF	IC2
4	1	uPC2410AHF	IC3
5	1	PI22A06M	J1

REMOTE UNIT

Part	Used	PartType	Designators
1	5	100pF (Cer)	C2 C3 C4 C12 C13
2	1	10nF (Cer)	C11
3	1	0.1uF (Cer)	C1
4	5	2.2uF/16V(Tan)	C6 C7 C8 C9 C10
5	1	100uF/10V(Ele)	C5
6	1	100K	R1
7	1	220uH	L1
8	2	BLM21A121	L2 L3
9	1	MAX232CSE	IC1
10	1	TC4S81F	IC2
11	1	HSJ0847-01-010	J4
12	1	JPJ2545-01-510	J5
13	1	PI22B04M	J2
14	1	PI28B06M	J1
15	1	PI28B08M	J7
16	1	09KC0019	J3
17	1	TCS6180-01-1010	J6
18	1	JP-No.110	JP1

AFC UNIT

Part	Used	PartType	Designators
1	1	15pF (Cer)	C1
2	1	100pF(Cer UJ)	C5
3	1	150pF(Cer)	C15
4	1	270pF(Cer UJ)	C4
5	1	330pF(Cer UJ)	C2
6	2	1nF (Cer)	C11 C13
7	2	10nF (Cer)	C6 C12
8	3	0.1uF (Cer)	C3 C9 C14
9	1	2.2uF/16V (Tan)	C8
10	1	4.7uF/6.3V(Tan)	C7
11	1	10uF/6.3V (Os)	C10
12	2	100	R11 R12
13	1	470	R6
14	3	4.7K	R7 R14 R15
15	2	6.8K	R3 R4
16	2	10K	R2 R13
17	1	39K	R9
18	1	47K	R5
19	1	56K	R8
20	1	100K	R10
21	2	KE-04980	T1 T2
22	1	2SK160	Q1
23	1	TC4W53F	IC1
24	1	MC3372M	IC2
25	1	uPC358G	IC3
26	1	PI28A10M	J1

ACC1 UNIT

Part	Used	PartType	Designators
1	1	TCS7932-18-201	J1

SAM UNIT

Part	Used	PartType	Designators
1	2	22pF (Cer)	C20 C21
2	2	330pF(Cer)	C18 C19
3	3	1nF (Cer)	C15 C16 C17
4	1	0.1uF (Cer)	C28
5	4	2.2uF/16V(Tan)	C22 C23 C24 C25
6	2	33uF/10V (Ele)	C26 C27
7	1	220	R37
8	1	470	R43
9	3	1K	R28 R29 R30
10	5	2.2K	R23 R24 R25 R26 R27
11	4	10K	R31 R32 R33 R34
12	2	39K	R35 R36
13	1	47K	R41
14	2	100K	R39 R40
15	1	220K	R22
16	1	470K	R42
17	1	RB500V-40	D2
18	3	2SC1009A	Q5 Q6 Q7
19	1	DTC144TK	Q8
20	1	MC14046B	IC4
21	2	TC4W53F	IC5 IC6
22	2	KE-04980	T3 T4
23	2	PI28A09M	J1

TRSW1 UNIT

Part	Used	PartType	Designators
1	1	68nF(Cer)	C1
2	1	DTC124EK	Q1

TRSW2 UNIT

Part	Used	PartType	Designators
1	1	10uF/6.3V(Tan)	C1
2	1	DTC124EK	Q1

TRSW3 UNIT

Part	Used	PartType	Designators
1	1	10K	R1
2	1	DTC124EK	Q1

NB UNIT

Part	Used	PartType	Designators
1	1	10pF (Cer)	C33
2	1	27pF (Cer)	C38
3	3	47pF (Cer)	C34 C35 C36
4	4	1nF (Cer)	C26 C27 C29 C31
5	10	10nF (Cer)	C2 C6 C7 C9 C12 C13 C14 C16 C18 C22
6	1	47nF (Cer)	C39
7	1	0.1uF(Cer)	C1
8	1	1uF/16V(Tan)	C32
9	2	100	R35 R36
10	2	220	R43 R44
11	1	330	R49
12	2	470	R38 R39
13	3	1K	R14 R18 R30
14	1	4.7K	R46
15	4	10K	R4 R5 R8 R9
16	1	15K	R34
17	2	22K	R32 R33
18	3	33K	R1 R2 R3
19	1	39K	R45
20	1	47K	R40
21	1	47K(RH0421CS4J47K)	VR1
22	2	100K	R47 R48
23	2	150K	R41 R42
24	1	ND411G-1	D1
25	4	2SC1009A	Q14 Q15 Q16 Q17
26	2	2SC1623	Q11 Q12
27	1	2SK520	Q18
28	1	3SK131	Q19
29	1	DTA124EK	Q1
30	1	DTC124TK	Q20
31	1	DTC144TK	Q13
32	1	uPD4528BG	IC1
33	3	KE-07791	T1 T2 T5
34	1	PI28A08M	J1
35	1	JP-No.128	JP1
36	1	JP-No.129	JP2

PHONE UNIT

Part	Used	PartType	Designators
1	2	100	R1 R2
2	1	HLJ2305-01-3070	J1

AR5000 PARTS LIST MISCELLANEOUS

FRONT PANEL ASSEMBLY

1. PLASTIC FRONT PANEL
2. ACRYLE WINDOW
3. BEARING
4. BRAKE LEVER
5. KEYTOP POWER
6. KEYTOP FUNC
7. KEYTOP 1
8. KEYTOP 2
9. KEYTOP 3
10. KEYTOP 4
11. KEYTOP 5
12. KEYTOP 6
13. KEYTOP 7
14. KEYTOP 8
15. KEYTOP 9
16. KEYTOP .
17. KEYTOP SRCH
18. KEYTOP SCAN
19. KEYTOP PRIO
20. KEYTOP VFO
21. KEYTOP MODE
22. KEYTOP STEP
23. KEYTOP PASS
24. KEYTOP MHz
25. KEYTOP kHz
26. KEYTOP ATT
27. KEYTOP CLR
28. KEYTOP UP
29. KEYTOP DOWN
30. KNOB MAIN DIAL
31. KNOB SUB DIAL
32. KNOB VOL/SQL 2pcs. w/white line
33. ENCODER MAIN EC24B , RES20D50-201-1 for s/n 077001 up
34. ENCODER SUB EC16B , RVB35KCINA1-2-24PCE for s/n 077001 up
35. POTENTIOMETER VOL RK097-50KA
36. POTENTIOMETER SQL RK097-10KC
37. SOCKET ACC1 TCS7972
38. SOCKET PHONES HLJ2305

REAR PANEL ASSEMBLY

1. COAXIAL SOCKET ANT1 WA-N220
2. COAXIAL SOCKET ANT2 WA-M220
3. COAXIAL SOCKET IF BNC-L80
4. COAXIAL SOCKET STD BNC-L210
5. POWER SOCKET J0409
6. MUTE SOCKET JPJ2545
7. EXT. SP SOCKET HSJ0847
8. REMOTE SOCKET 09KC0019
9. ACC2 SOCKET TCS6180

ENCLOSURE

1. UPPER CASE
2. LOWER CASE WITH SPEAKER, HOOD AND ATTACHMENT)
3. PLASTIC LEG WITH MOLDED SCREW 4 PCS.
4. PLASTIC SUPPORT WITH METAL INSERT 2 PCS.
5. RUBBER FOOT 4 PCS.

AR5000 EXPLODED VIEW

